

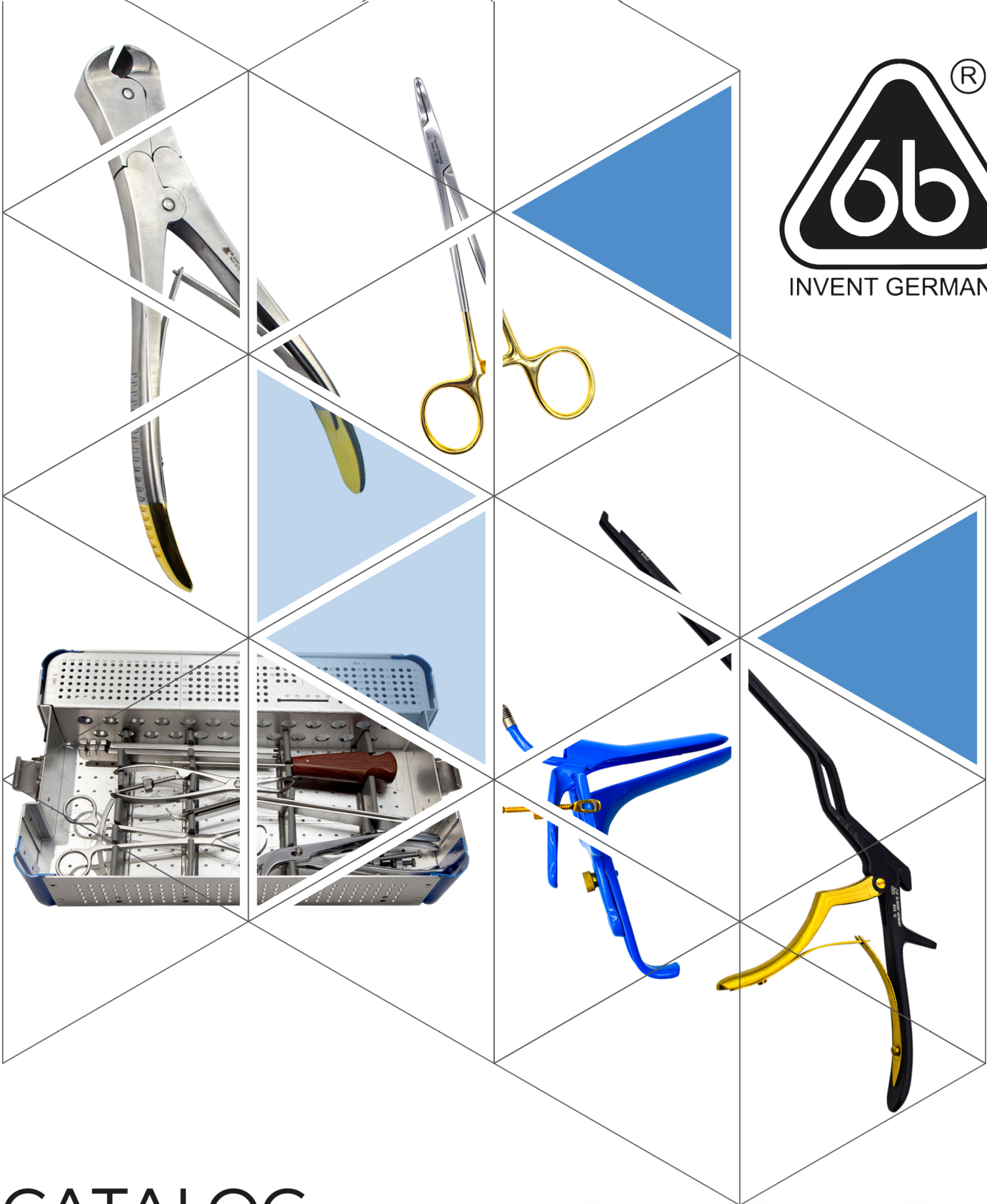

INVENT GERMANY



# CATALOG MEDICAL

**6b INVENT**  
GERMANY INSTRUMENTS  
THE BEST QUALITY SINCE 1958

**Stirnspiegel ; Espejo  
Head Mirrors ; Riflettore  
Miroirs Frontaux ; Espelho**



Ziegler-Renova  
1-01-90  
90 mm Ø

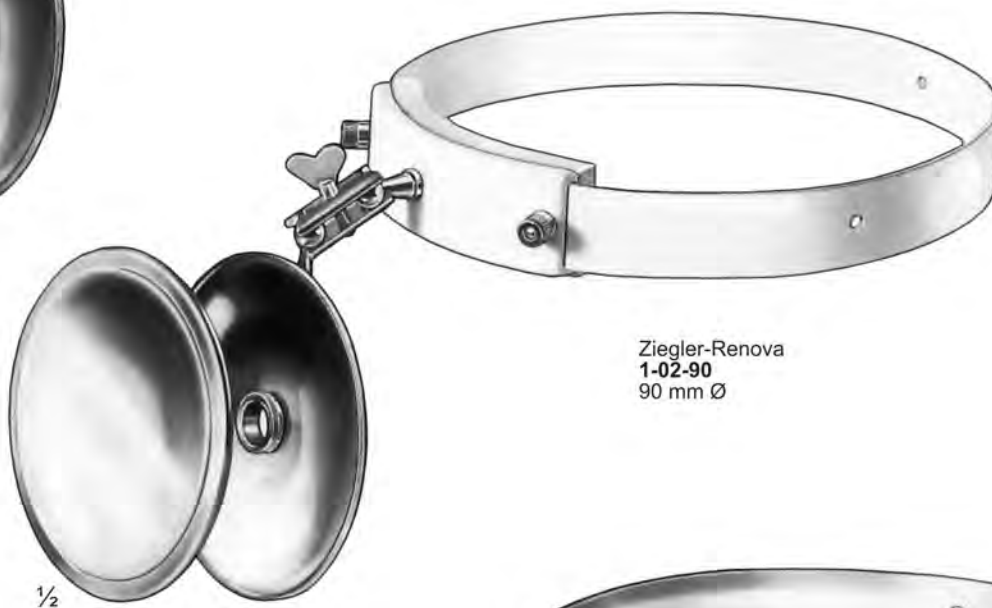

Ziegler-Renova  
1-02-90  
90 mm Ø

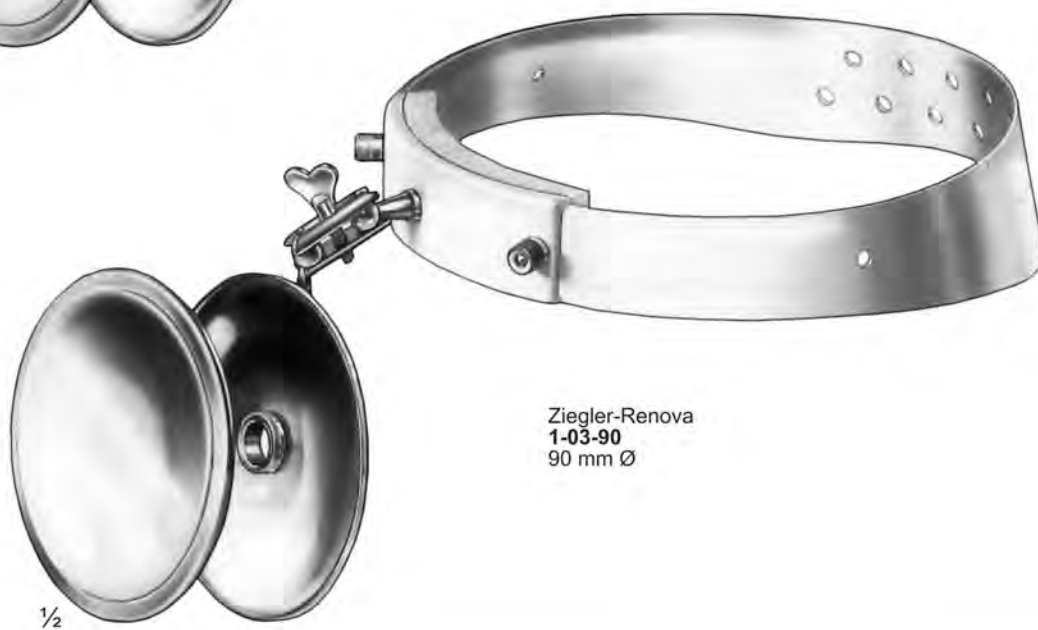

Ziegler-Renova  
1-03-90  
90 mm Ø

**Stirnspiegel ; Espejo  
Head Mirrors ; Riflettore  
Miroirs Frontaux ; Espelho**



Ziegler  
2-01-90 90 mm Ø  
2-02-100 100 mm Ø



Ziegler  
2-03-90 90 mm Ø  
2-04-100 100 mm Ø

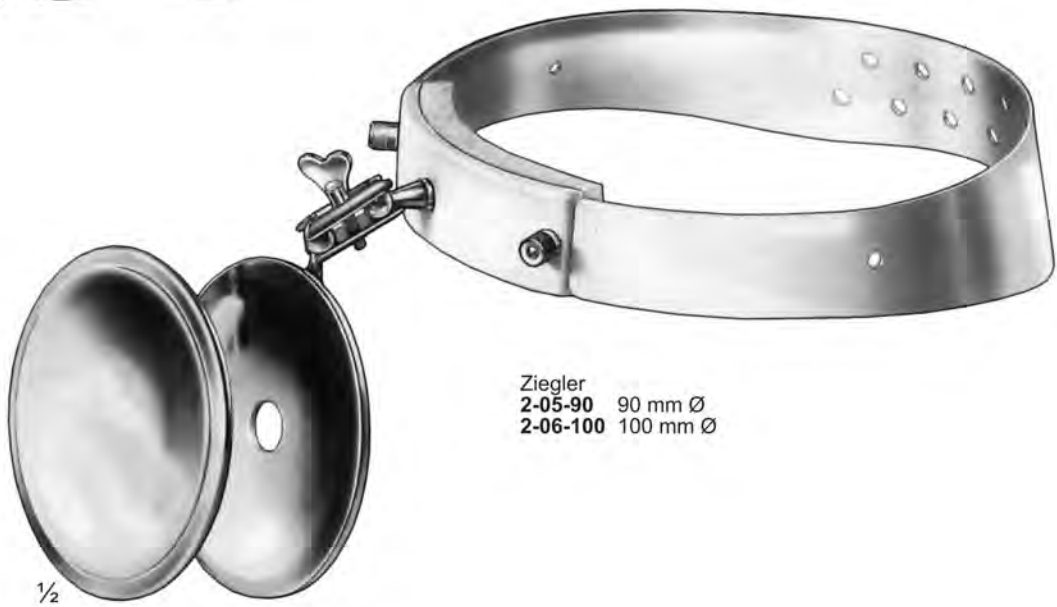

Ziegler  
2-05-90 90 mm Ø  
2-06-100 100 mm Ø

**Stirnspiegel ; Espejo  
Head Mirrors ; Riflettore  
Miroirs Frontaux ; Espelho**



1/2

Ziegler  
3-01-90 90 mm Ø  
3-02-100 100 mm Ø

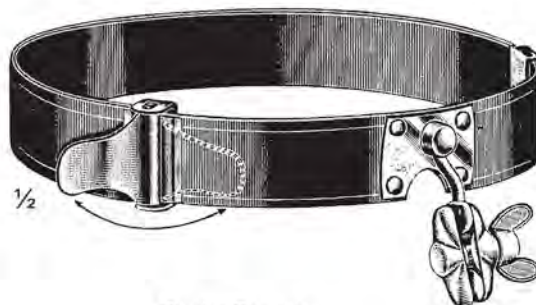

1/2

Ziegler-Renova  
3-03-90 90 mm Ø  
3-04-100 100 mm Ø



1/2

Ziegler  
3-05-90 90 mm Ø  
3-06-100 100 mm Ø  
Head mirror only



1/2

Ziegler  
3-07-90 90 mm Ø  
3-08-100 100 mm Ø  
Head mirror only  
with rubber edging

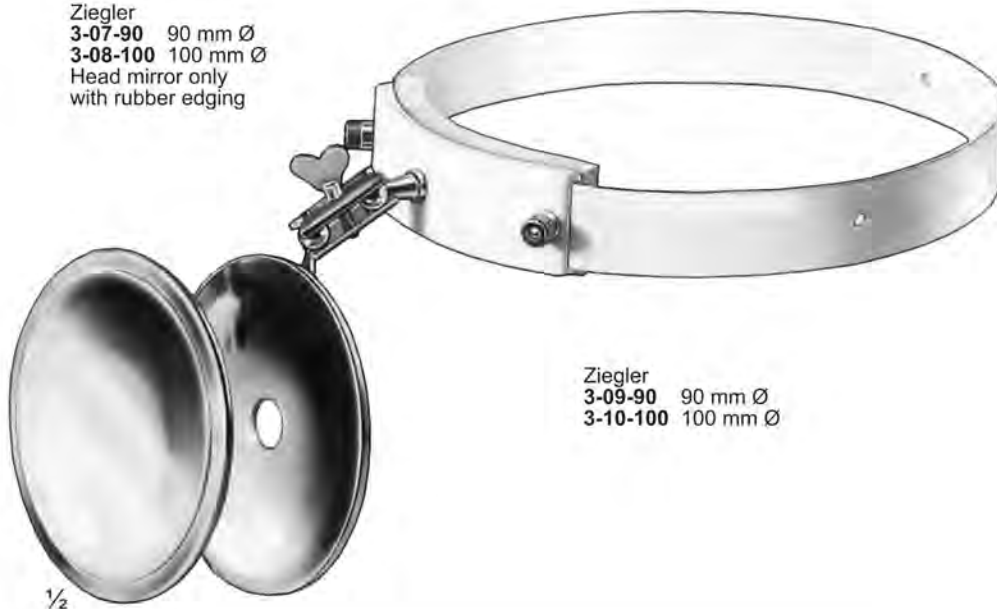

1/2

Ziegler  
3-09-90 90 mm Ø  
3-10-100 100 mm Ø

**Schutzmaske & Stirnlampen  
Protecting Shield & Head Lights  
Eclaireurs Frontaux & Lampe Frontale**



4-01-00



4-02-00  
Protecting shield only

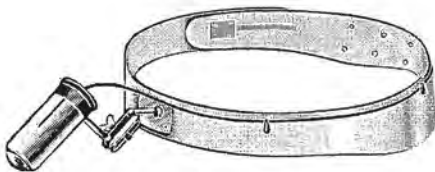

Jansen  
4-03-90 90 mm Ø  
4-04-100 100 mm Ø



Jansen  
4-05-90 90 mm Ø  
4-06-100 100 mm Ø

**Stethoskope ; Fonendoscopios  
Stethoscopes & Accessories ; Fonendoscopi  
Stéthoscopes ; Estetoscópios**



Ford  
**5-01-00**  
Double outlet



**5-02-00**  
Double outlet



Bowles  
**5-03-00**  
Single outlet



**5-04-00**  
Single outlet



**5-02-00**



**5-03-00**

**Stethoskope ; Fonendoscopios  
Stethoscopes & Accessories ; Fonendoscopi  
Stéthoscopes ; Estetoscópios**



Streamliner  
6-01-00  
Single outlet



Snowden  
6-02-00  
Double outlet



Snowden  
6-03-00  
Double outlet  
Folding  
frame



6-02-00

**Stethoskope ; Fonendoscopios  
Stethoscopes & Accessories ; Fonendoscopi  
Stéthoscopes ; Estetoscópios**

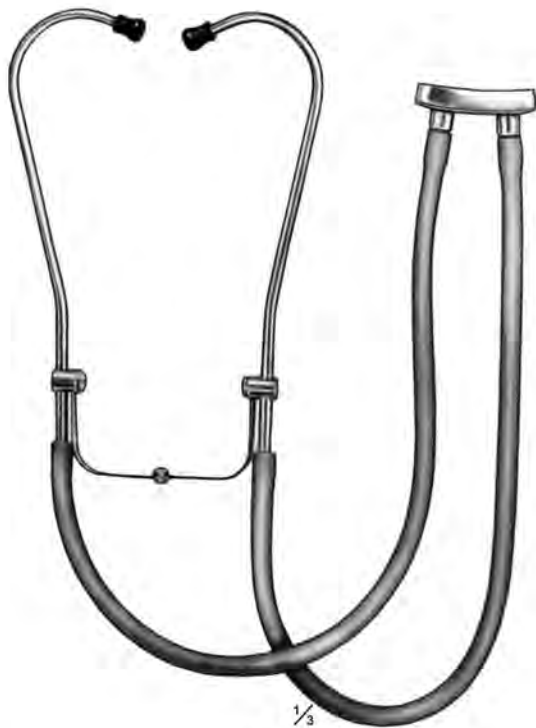

$\frac{1}{3}$   
Hartert (Stereo)  
7-01-00  
Double outlet



$\frac{1}{3}$   
Trioфон  
7-02-00  
Single outlet



$\frac{1}{3}$   
Reiger-Sprague  
7-03-00  
Double outlet



**Stethoskope ; Fonendoscopios  
Stethoscopes & Accessories ; Fonendoscopi  
Stéthoscopes ; Estetoscópios**



Anestophon  
8-01-00  
Single outlet



$\frac{1}{2}$   
Pinard  
8-02-15  
15.5 cm / 6 $\frac{1}{8}$ "



$\frac{1}{2}$   
Pinard  
8-03-18  
18 cm / 7"



$\frac{1}{2}$   
8-04-14  
14.5 cm / 5 $\frac{1}{2}$ "  
Wooden



$\frac{1}{2}$   
Pinard  
8-05-15  
15 cm / 6"



$\frac{1}{2}$   
Scholle  
8-06-19  
19 cm / 7 $\frac{1}{2}$ "

**Stethoskope ; Fonendoscopios  
Stethoscopes & Accessories ; Fonendoscopi  
Stéthoscopes ; Estetoscópios**



**9-01-00**  
Binaural,  
Spring screwed on



**9-02-00**



**9-03-00**  
Binaural, Short type



**9-04-00**



**9-05-06**  
6 mm Ø

**Messinstrumente ; Instrumento de medir  
Measuring Instruments ; Strumenti di Misura  
Instruments du Mesur ; Medição**



1/2

Castroviejo  
10-01-07  
7.5 cm / 3"



1/2

10-02-15  
15 cm / 6"

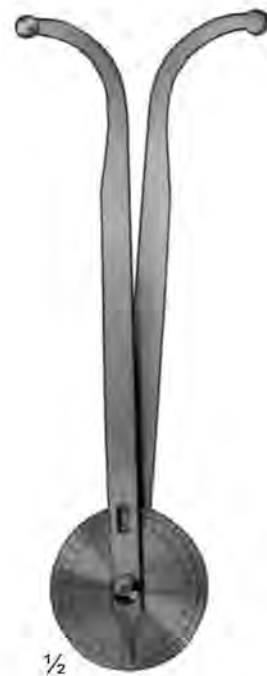

1/2

Thole  
10-05-00



Bertillon  
10-03-32  
32 cm / 12 3/4"



1/3

Moeltgen  
10-04-18  
18 cm / 7"

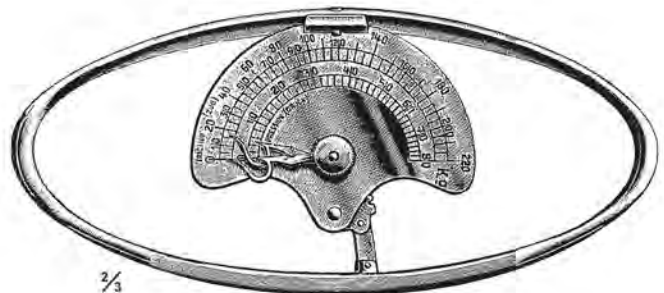

2/3

Collin  
10-06  
12.5 cm / 5"  
Pressure traction  
100-300 Kg

**Messinstrumente ; Instrumento de medir  
Measuring Instruments ; Strumenti di Misura  
Instruments du Mesur ; Medição**



1/2  
Aly  
11-01-17  
17 cm / 6 3/4"



1/2  
Wartenberg  
11-02-19  
19 cm / 7 1/2"



1/2  
Weber  
11-03-11  
11 cm / 4 1/4"



1/2  
Weber  
11-04-17  
17 cm / 6 3/4"



1/2  
11-06-26  
26 cm / 10 1/4" 45°



1/2  
11-07-24  
24 cm / 9 1/2" 90°



1/2  
11-05-23  
23 cm / 9"

**Diagnose Set ; Establecer el Diagnóstico**  
**Diagnostic Set ; Set di Diagnostica**  
**Ensemble de Diagnostic ; Conjunto de Diagnósticos**



**12-01-00**  
Battery handle



**12-02-00**  
Battery handle



**12-03-00**  
Battery handle



**12-04-00**  
Battery handle



Chiron  
**12-05-00**  
Otoscope



**12-06-00**  
Otoscope



**12-07-00**  
Complete set consisting :  
1 Battery handle, 1 Nasal speculum  
3 Ear specula, 1 Tongue blade, 1 Mirror handle  
4 Bulbs and 2 Mirrors



**12-08-00**  
Complete set consisting :  
1 Battery handle, 1 Nasal speculum  
3 Ear specula and 2 Bulbs

**Diagnose Set ; Establecer el Diagnóstico**  
**Diagnostic Set ; Set di Diagnostica**  
**Ensemble de Diagnostic ; Conjunto de Diagnósticos**



1/3

**Universal**  
**13-01-00**  
 Complete set consisting :  
 1 Battery handle, 1 Otoscope with 3 ear specula,  
 1 Ophthalmoscope, 1 Nasal speculum, 2 Mirrors with holder,  
 1 Tongue depressor holder and 2 Bulbs



**13-02-00**  
 Complete set consisting :  
 1 Battery handle, 5 Ear specula,  
 1 Nasal speculum and 1 Tongue blade holder



**13-03-00**  
 Complete set consisting :  
 1 Battery handle, 1 Otoscope with 3 Ear specula,  
 1 Nasal speculum, 1 Mirror with holder and  
 1 Tongue blade

**Diagnose Set ; Establecer el Diagnóstico**  
**Diagnostic Set ; Set di Diagnostica**  
**Ensemble de Diagnostic ; Conjunto de Diagnósticos**



**Halnaso**  
**14-01-00**  
 Complete set consisting :  
 1 Battery handle, 3 Ear specula, 1 Nasal speculum,  
 2 Mirrors with holder, 1 Tongue depressor holder and  
 2 Bulbs



**14-02-00**  
 Otoscope set consisting :  
 1 Battery handle, 3 Ear specula and 1 Bulb



**14-03-00**  
 Ophthalmoscope set consisting :  
 1 Battery handle, 1 Ophthalmoscope with 3 stepless focusing,  
 1 Illumination lens and 1 Bulb



**14-04-00**  
 Complete set consisting :  
 1 Battery handle, 5 Ear specula, 1 Nasal speculum,  
 1 Bulb, 1 Speculum holder, 1 Wire spatula and  
 2 Wooden spatulas

**Anästhesie Masken ; Máscara para Anestesia  
 Anaesthesia Masks ; Maschera per Anestesia  
 Masque pour l'Anesthésie ; Máscara para Anestesia**



Baby-Esmarch  
15-01-00

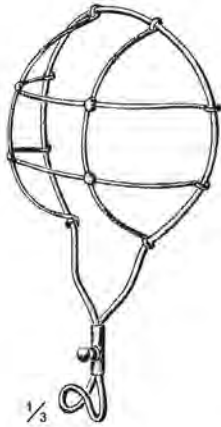

Esmarch  
15-02-00



Esmarch  
15-03-00



Esmarch  
15-04-00



Schimmelbusch  
15-05-00



Schimmelbusch  
15-06-00

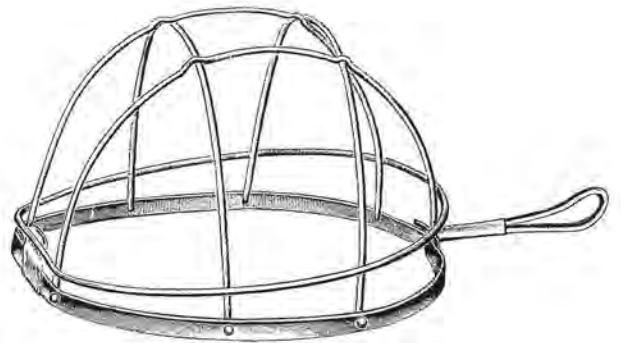

Juillard  
15-07-00

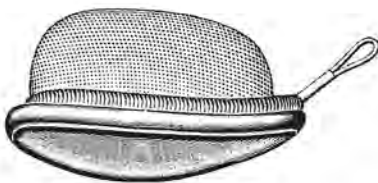

Yankauer  
15-08-00

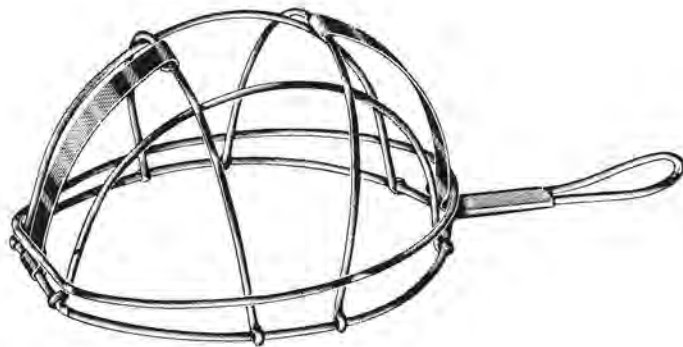

Juillard  
15-09-00



**Reflexhammer ; Martillo de reflejos  
Reflex Hammers ; Martello Riflessi  
Marteaux de Percussion ; Martelo de Reflexos**

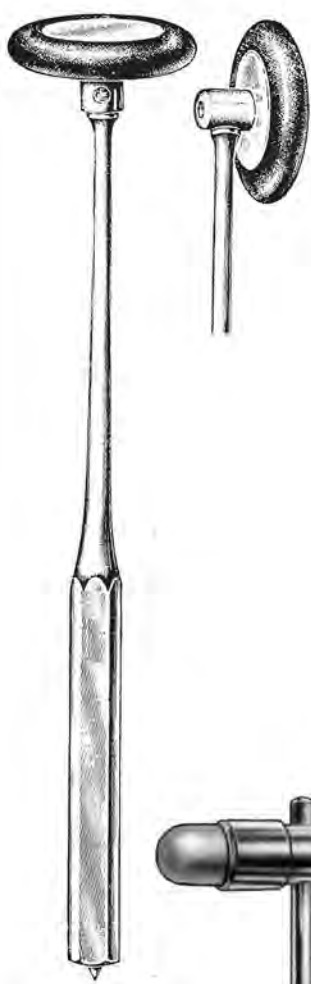

Babinski  
16-01-22  
22 cm / 8¾"

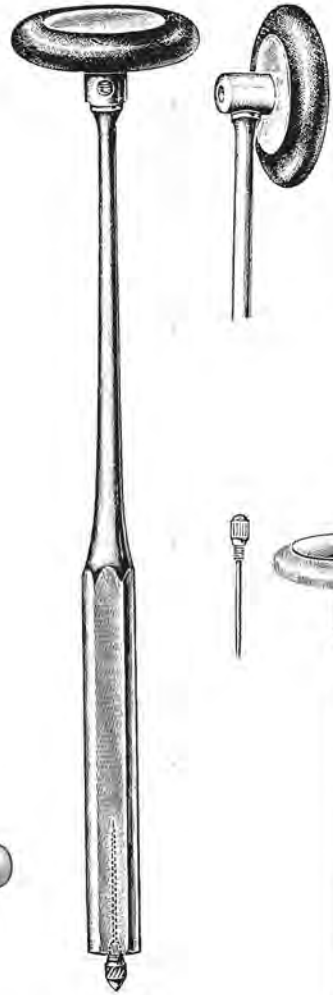

Babinski  
16-02-22  
22 cm / 8¾"



Telescopic  
16-03-15  
Closed size 15 cm / 6"



Buck  
16-04-18  
18 cm / 7"  
Closed size 9 cm / 3½"

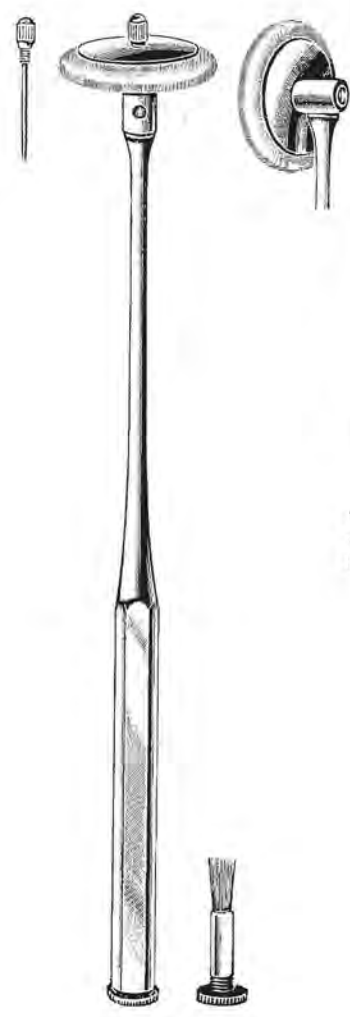

Rabiner  
16-05-25  
25 cm / 10"

Telescopic  
16-03-15  
Full  
Opening  
38 cm / 15"

**Reflexhammer ; Martillo de reflejos  
 Reflex Hammers ; Martello Riflessi  
 Marteaux de Percussion; Martelo de Reflexos**



$\frac{1}{2}$   
 Taylor  
 17-01-18 18 cm / 7"  
 17-02-20 20 cm / 8"



$\frac{1}{2}$   
 Taylor  
 17-03-18 18 cm / 7"  
 17-04-20 20 cm / 8"

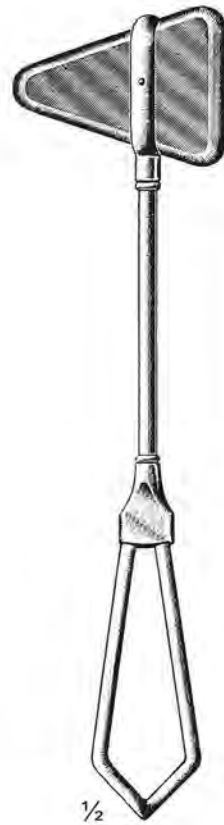

$\frac{1}{2}$   
 Taylor  
 17-05-18 18 cm / 7"  
 17-06-20 20 cm / 8"

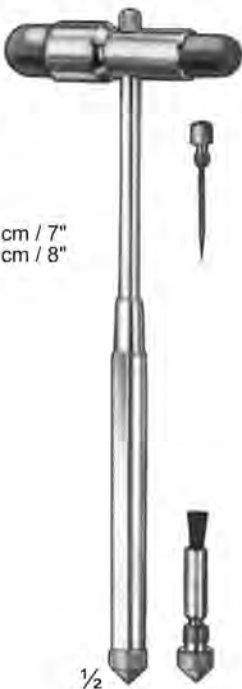

$\frac{1}{2}$   
 Buck  
 17-07-18 18 cm / 7"  
 17-08-20 20 cm / 8"



$\frac{1}{2}$   
 Mobile  
 17-09-19  
 19 cm / 7½"



17-10-18 18 cm / 7"  
 17-11-20 20 cm / 8"  
 17-12-25 25 cm / 10"  
 17-13-30 30 cm / 12"

$\frac{1}{3}$   
 Vernon  
 17-10 To 17-13

**Reflexhammer ; Martillo de reflejos  
Reflex Hammers ; Martello Riflessi  
Marteaux de Percussion; Martelo de Reflexos**

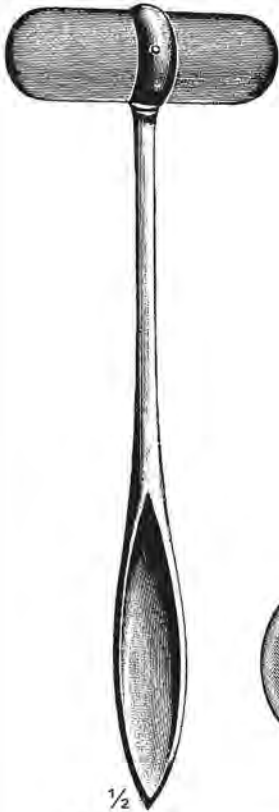

1/2  
Dajerine  
18-01-18 18 cm / 7"  
18-02-20 20 cm / 8"



1/2  
Dajerine  
18-03-18 18 cm / 7"  
18-04-20 20 cm / 8"



1/2  
Dajerine  
18-05-18 18 cm / 7"  
18-06-20 20 cm / 8"

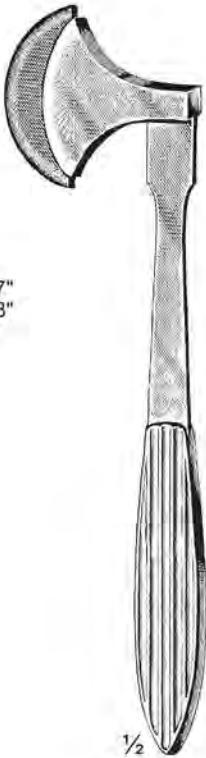

1/2  
Berliner  
18-07-18 18 cm / 7"  
18-08-20 20 cm / 8"

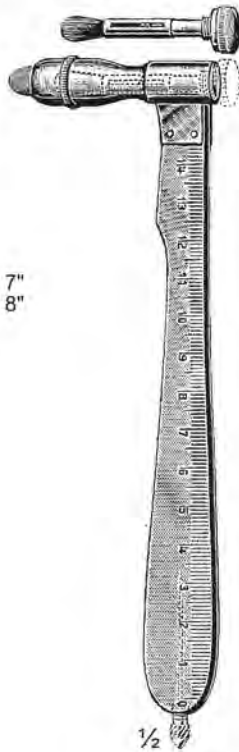

1/2  
Ebstein  
18-09-18  
18 cm / 7"

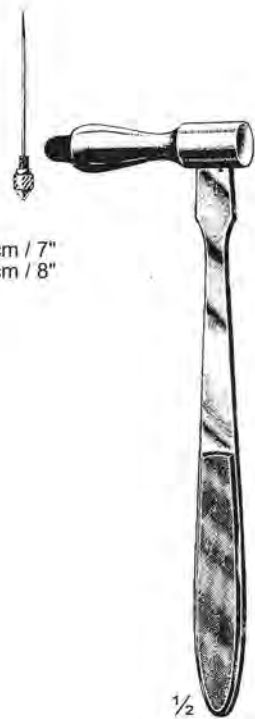

1/2  
Traube  
18-10-16  
16 cm / 6 1/4"

**Reflexhammer ; Martillo de reflejos  
 Reflex Hammers ; Martello Riflessi  
 Marteaux de Percussion; Martelo de Reflexos**

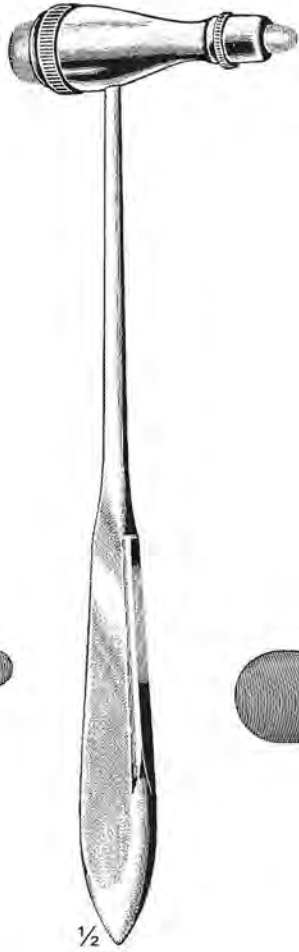

1/2  
 Troemner  
 19-01-24  
 24.5 cm / 9 3/4"

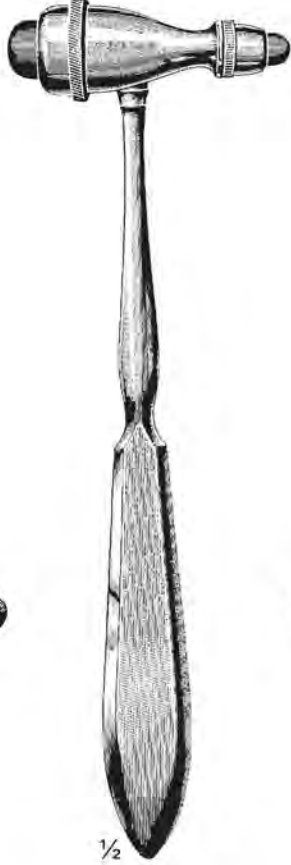

1/2  
 Troemner  
 19-02-24  
 24 cm / 9 1/2"



1/2  
 Drivers Douflex  
 Mod. Dejerine  
 19-03-22  
 22 cm / 8 3/4"



1/2  
 Neuro Douflex  
 Mod. Dejerine  
 19-04-22  
 22 cm / 8 3/4"



1/2  
 Troemner  
 Simplex  
 19-05-21  
 21 cm / 8 1/4"

Skalpellgriffe ; Mangos de bisturí  
 Scalpel Handles ; Manici di bisturí  
 Manches pour bistouries ; Mango de bisturí

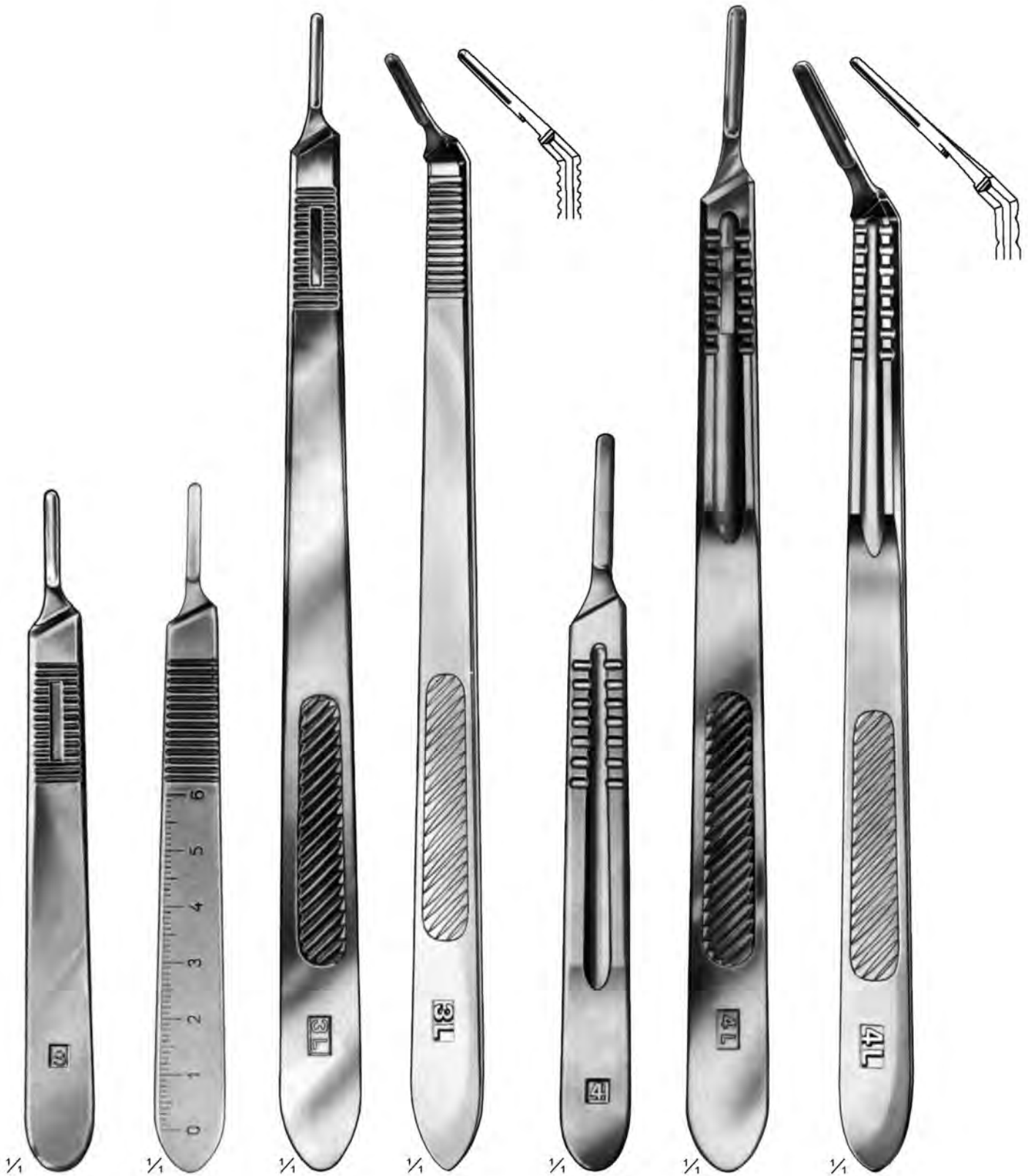

20-01-03  
 12.5 cm / 5"  
 No. 3

20-02-03  
 12.5 cm / 5"  
 No. 3

20-03-03  
 21 cm / 8¼"  
 No. 3 L

20-04-03  
 20 cm / 8"  
 No. 3 L

20-05-04  
 13.5 cm / 5¼"  
 No. 4

20-06-04  
 21 cm / 8¼"  
 No. 4 L

20-07-04  
 20 cm / 8"  
 No. 4 L

Skalpelli griffe ; Mangos de bisturí  
 Scalpel Handles ; Manici di bisturi  
 Manches pour bistouries ; Mango de bisturi



21-01-03  
 15 cm / 6"  
 No. 3  
 Hollow  
 handle



21-02-34  
 15.5 cm / 6 1/8"  
 No. 3, 4  
 Double ended



21-03-07  
 12.5 cm / 5"  
 No. 7 K



21-04-07  
 16 cm / 6 1/4"  
 No. 7



21-05-07  
 16 cm / 6 1/4"  
 No. 7



21-06-16  
 16 cm / 6 1/4"

**Skalpellgriffe ; Mangos de bisturí  
Scalpel Handles ; Manici di bisturi  
Manches pour bistouries ; Mango de bisturi**



1/1

**22-01-03**  
12.5 cm / 5"  
No. 3



1/1

**22-02-04**  
12.5 cm / 5"  
No. 4



1/1

Collin  
**22-03-08**  
13 cm / 5 1/8"  
No. 8



1/1

Collin  
**22-04-09**  
13 cm / 5 1/8"  
No. 9



1/1

**22-05-10**  
15 cm / 6"  
No. 10

Skalpellgriffe ; Mangos de bisturí  
 Scalpel Handles ; Manici di bisturi  
 Manches pour bistouries ; Mango de bisturi



1/1  
**23-01-13**  
 13 cm / 5 1/8"  
 Plastic handle



1/1  
**23-02-27**  
 27 cm / 10 3/4"



1/1  
**23-03-21**  
 21 cm / 8 1/4"



1/1  
**23-04-23**  
 23 cm / 9"



1/1  
**23-05-23**  
 23 cm / 9"



1/1  
**23-06-23**  
 23 cm / 9"



**Klingenbrecher ; Rompe-hojas de afeitar**  
**Razor Blade Breakers ; Pince rompe-lamette per la microchirurgia**  
**Casse-lames de rasoir ; Razor-titular da lâmina e disjuntor**



24-02-09  
Cur

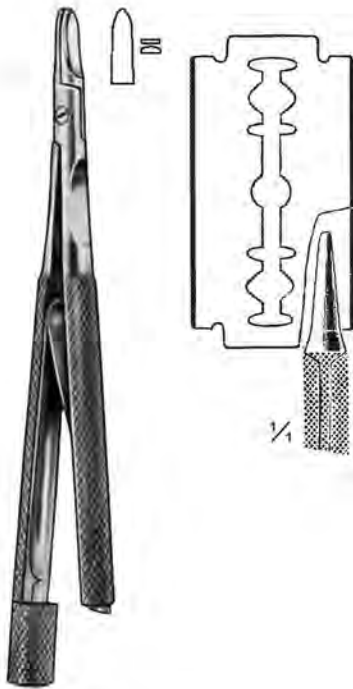

24-01-09 Str  
Troutman  
Chris  
24-01-09 & 24-02-09  
9 cm / 3½"  
5.5 mm



24-05-18  
18.5 cm / 7¼"



Castroviejo  
24-06-13  
13 cm / 5¼"  
8 mm



24-03-11  
11 cm / 4¼"



24-04-12  
12 cm / 4¾"



24-07-16  
16 cm / 6¼"

Anatomische Skalpelle ; Bisturías para dissección  
 Dissection knives ; Bisturi dissezione  
 Bistouris à dissection ; Bisturis dissecando

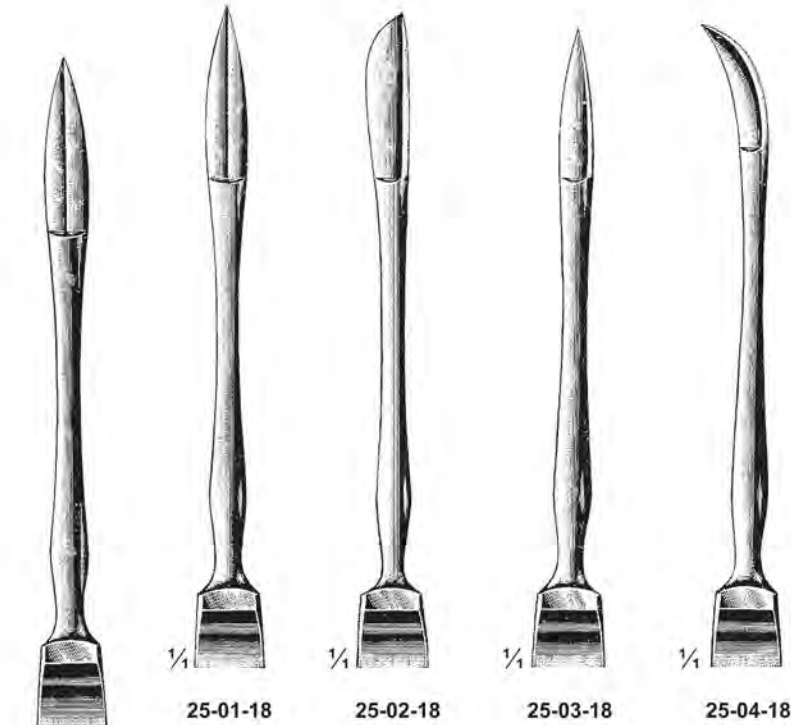

25-01-18 To 25-04-18  
 18.5 cm / 7 1/4"



25-05-16  
 16 cm / 6 1/4"  
 With handle

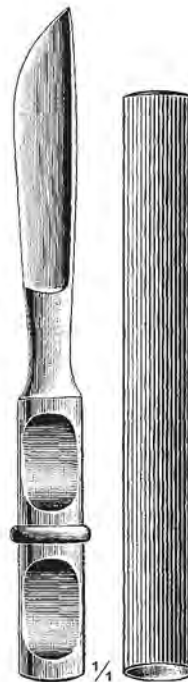

25-06  
 16 cm / 6 1/4"  
 With handle



Farabeuf  
 25-07  
 19 cm / 7 1/2"

Anatomische Skalpelle ; Bisturíes para dissección  
 Dissection knives ; Bisturi dissezione  
 Bistouris à dissection ; Bisturis dissecando

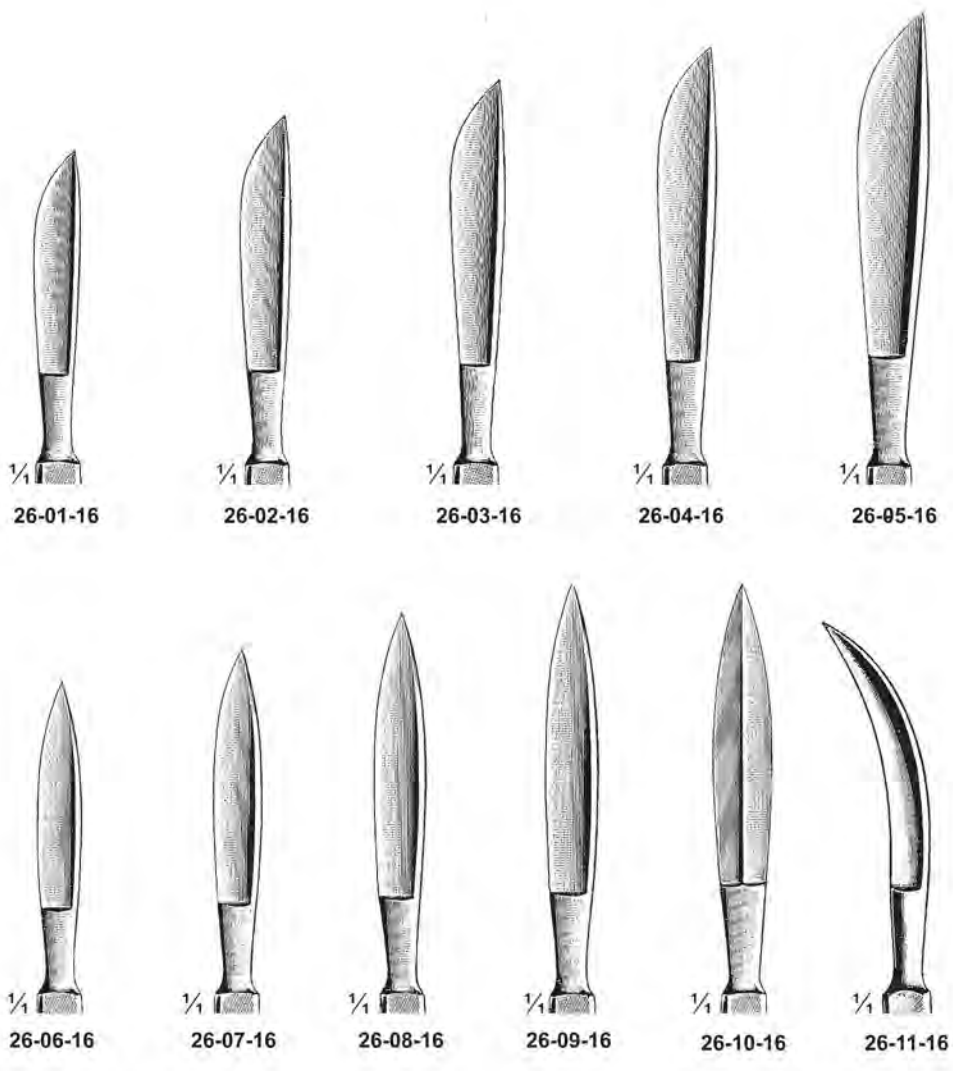

1/4 26-01-16    1/4 26-02-16    1/4 26-03-16    1/4 26-04-16    1/4 26-05-16  
 1/4 26-06-16    1/4 26-07-16    1/4 26-08-16    1/4 26-09-16    1/4 26-10-16    1/4 26-11-16

Dieffenbach  
 26-01-16 To 26-11-16  
 16 cm / 6 1/4"

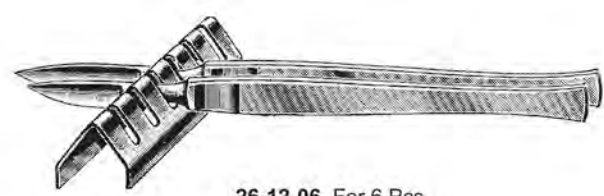

26-12-06 For 6 Pcs  
 26-13-09 For 9 Pcs  
 26-14-12 For 12 Pcs  
 Rack only

Anatomische Skalpelle ; Bisturías para dissección  
 Dissection knives ; Bisturi dissezione  
 Bistouris à dissection ; Bisturis dissecando



1/4

27-06-16

27-01-16 To 27-10-16  
 16.5 cm / 6 1/2"



1/4

27-01-16



1/4

27-02-16



1/4

27-03-16



1/4

27-04-16



1/4

27-05-16



1/4

27-07-16



1/4

27-08-16



1/4

27-09-16



1/4

27-10-16



Anatomische Skalpelle ; Bisturíes para dissección  
 Dissection knives ; Bisturi dissezione  
 Bistouris à dissection ; Bisturis dissecando

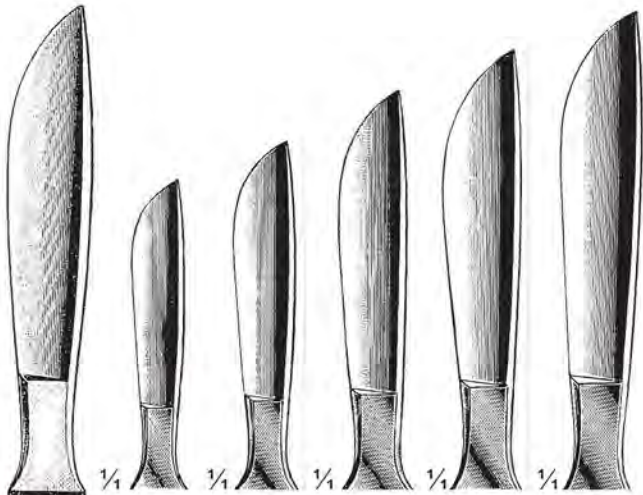

1/4 28-01-16 28-02-16 28-03-16 28-04-16 28-05-16  
 28-11-16 28-12-16 28-13-16 28-14-16 28-15-16

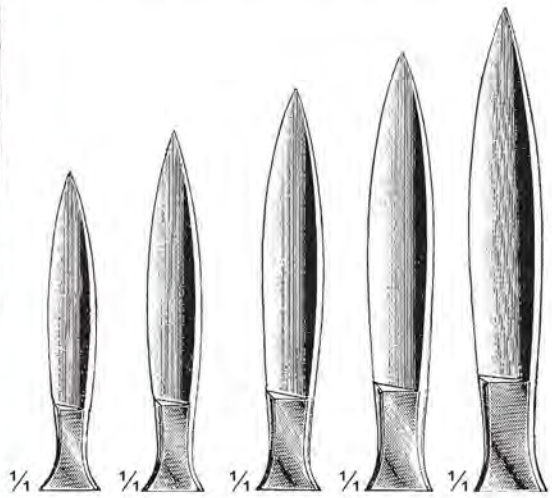

1/4 28-06-16 28-07-16 28-08-16 28-09-16 28-10-16  
 28-16-16 28-17-16 28-18-16 28-19-16 28-20-16

1/4 28-01-16 To 28-10-16  
 16.5 cm / 6 1/2"  
 Wooden handle



1/4 28-11-16 To 28-20-16  
 16.5 cm / 6 1/2"  
 Wooden handle



1/4 28-21-18 To 28-29-18  
 18 cm / 7"



1/4 28-21-18 28-22-18 28-23-18

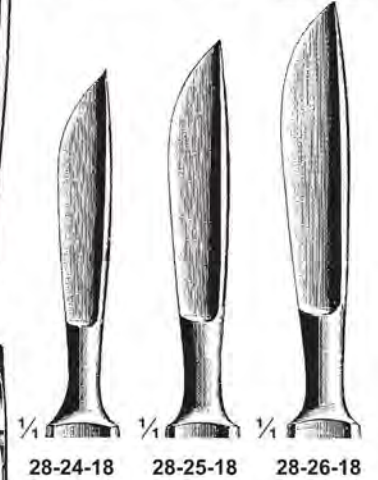

1/4 28-24-18 28-25-18 28-26-18

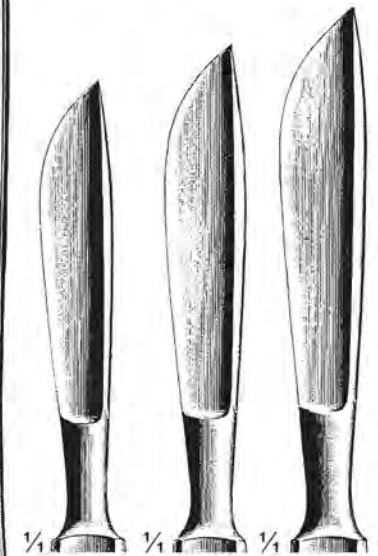

1/4 28-27-18 28-28-18 28-29-18



**Anatomische Skalpelle ; Bisturías para dissección  
Dissection knives ; Bisturi dissezione  
Bistouris à dissection ; Bisturis dissecando**



29-01-18 To 29-19-18  
18 cm / 7"



1/4  
29-01-18



1/4  
29-02-18



1/4  
29-03-18



1  
29-04-18



1  
29-05-18



1  
29-06-18



1  
29-07-18



1  
29-08-18



1  
29-09-18



1  
29-10-18



1  
29-11-18



1  
29-12-18

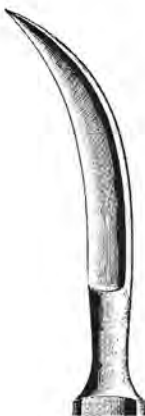

1/4  
29-13-18



1/4  
29-14-18



1/4  
29-15-18



1/4  
29-16-18



1/4  
29-17-18  
Tenotome



1/4  
29-18-18  
Tenotome



1/4  
Halle  
29-19-18  
19 cm / 7 1/2"

**Anatomische Skalpelle ; Bisturías para dissección  
Dissection knives ; Bisturi dissezione  
Bistouris à dissection ; Bisturis dissecando**

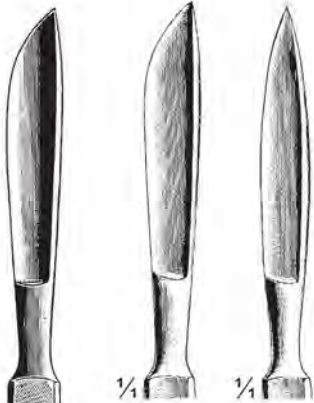

30-01-14 30-02-14



30-03-14 30-04-14

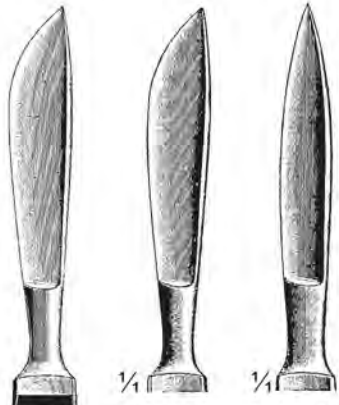

30-05-13 30-06-13



30-07-13

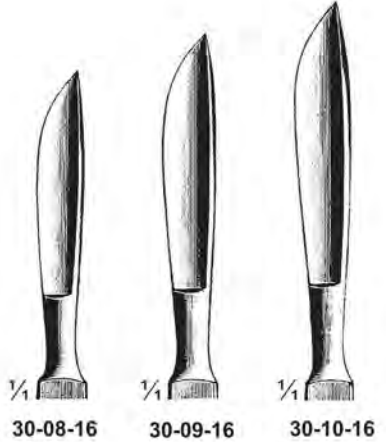

30-08-16 30-09-16 30-10-16

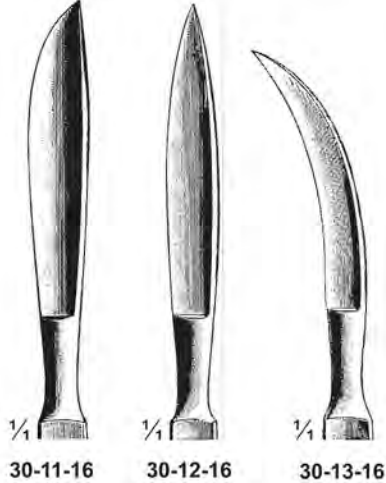

30-11-16 30-12-16 30-13-16

1/4  
**Bergmann**  
30-01-14 To 30-04-14  
14 cm / 5 1/2"

1/4  
**30-05-13 To 30-07-13**  
13.5 cm / 5 1/4"

1/4  
**Dieffenbach**  
30-08-16 To 30-13-16  
16 cm / 6 1/4"



Anatomische Skalpelle ; Bisturías para dissección  
Dissection knives ; Bisturi dissezione  
Bistouris à dissection ; Bisturis dissecando



1/4

Collin  
31-01-14 To 31-08-14  
14 cm / 5½"

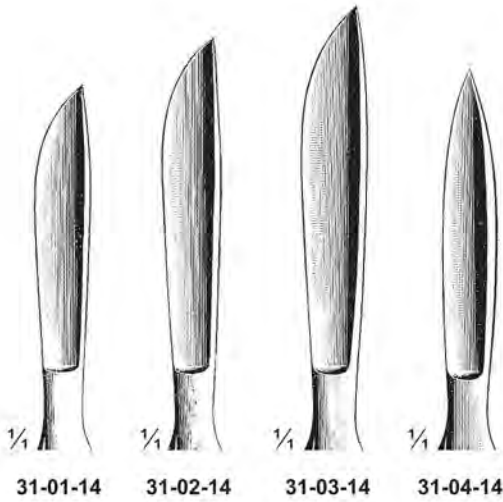

1/4

31-01-14

1/4

31-02-14

1/4

31-03-14

1/4

31-04-14

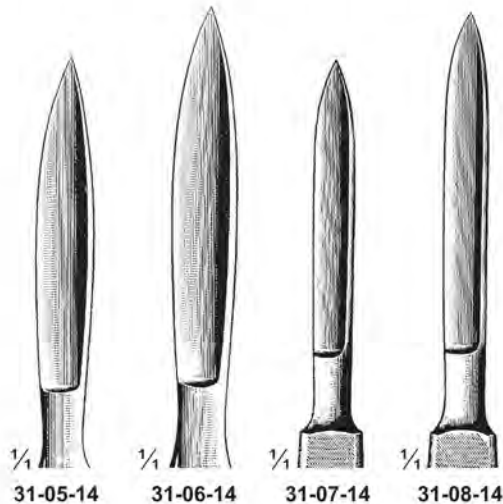

1/4

31-05-14

1/4

31-06-14

1/4

31-07-14

1/4

31-08-14



1/4

Simon  
31-09-20 To 31-12-20  
20 cm / 8"

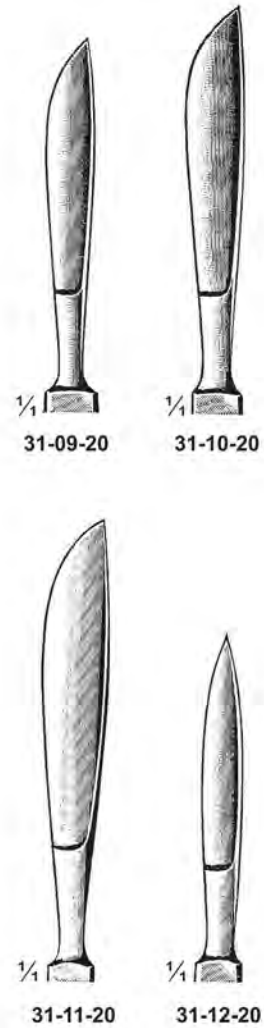

1/4

31-09-20

1/4

31-10-20

1/4

31-11-20

1/4

31-12-20





**Anatomische Skalpelle ; Bisturías para disección  
Dissection knives ; Bisturi dissezione  
Bistouris à dissection ; Bisturis dissecando**

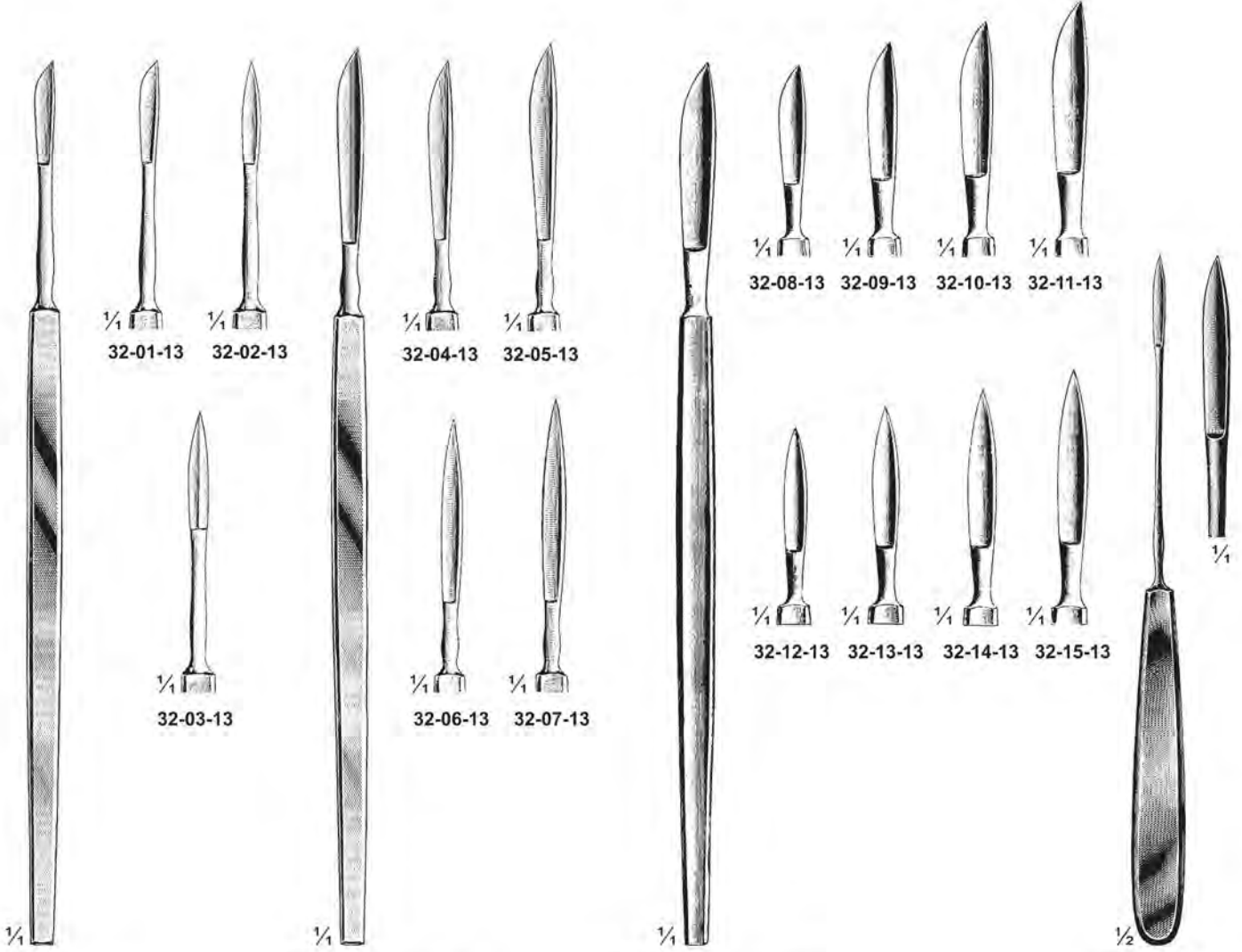

32-01-13    32-02-13

32-04-13    32-05-13

32-08-13    32-09-13    32-10-13    32-11-13

32-03-13

32-06-13    32-07-13

32-12-13    32-13-13    32-14-13    32-15-13

**Parker**  
32-01-13 To 32-03-13  
13.5 cm / 5 1/4"

**Adams**  
32-04-13 To 32-07-13  
13.5 cm / 5 1/4"

**Dieffenbach**  
32-08-13 To 32-15-13  
13 cm / 5 1/8"

**Halle**  
32-16-21  
21 cm / 8 1/4"  
Dura knife

**Anatomische Skalpelle ; Bisturías para dissección  
Dissection knives ; Bisturi dissezione  
Bistouris à dissection ; Bisturis dissecando**



Toennis  
33-01-13  
13 cm / 5 1/8"  
Dura knife



Toennis  
33-02-19  
19 cm / 7 1/2"  
Dura knife



Simon  
33-03-23 To 33-06-23  
23.5 cm / 9 1/4"

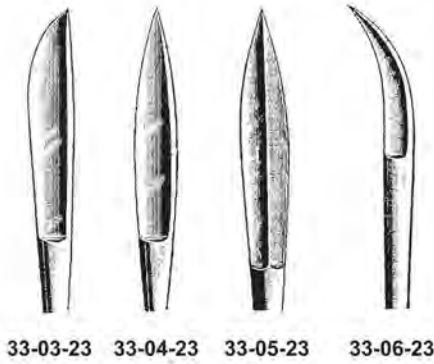

Item No. 33-03-23 To 33-16-23  
Fistula knives

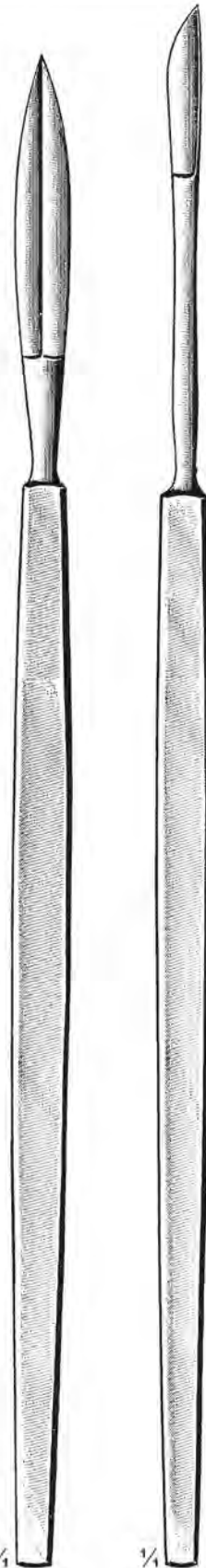

Schroeder  
33-15-22  
22 cm / 8 3/4"

Ulrich  
33-16-22  
22.5 cm / 8 7/8"

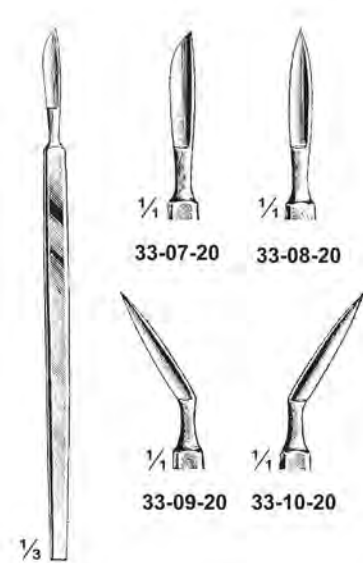

Simon  
33-07-20 To 33-10-20  
20 cm / 8"

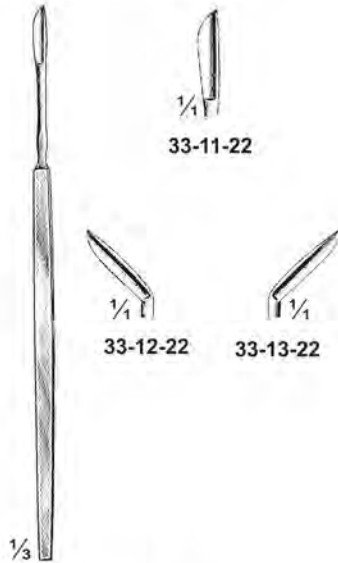

Simon  
33-11-22 To 33-13-22  
22.5 cm / 8 7/8"



Schroeder  
33-14  
22.5 cm / 8 7/8"

Anatomische Skalpelle ; Bisturías para dissección  
 Dissection knives ; Bisturi dissezione  
 Bistouris à dissection ; Bisturis dissecando



1/2

Sven Hanssen  
 34-01-14  
 14 cm / 5 1/2"

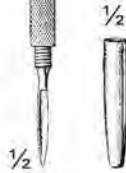
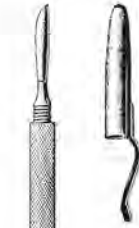

34-02-12  
 12 cm / 4 3/4"



Vaughan  
 34-03-12  
 12 cm / 4 3/4"

Item No. 34-01-14 To 34-07-13  
 Abscess knives



1/4

34-04-13  
 13 cm / 5 1/4"



1/4

34-05-12  
 12.5 cm / 5"



1/4

Dieffenbach  
 34-06-13  
 13 cm / 5 1/8"



1/4

Dieffenbach  
 34-07-13  
 13 cm / 5 1/8"



1/2

Olivecrona  
 34-08-20  
 20 cm / 8"  
 Trigeminal  
 knife



1/2

Olivecrona  
 34-09-23  
 23 cm / 9"  
 Trigeminal  
 knife



**Anatomische Skalpelle ; Bisturías para disección  
Dissection knives ; Bisturi dissezione  
Bistouris à dissection ; Bisturis dissecando**

Item No. 35-01-24 To 35-04-22  
Scarifying knives

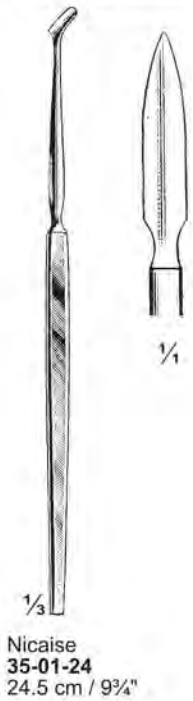

Nicaise  
35-01-24  
24.5 cm / 9 3/4"



Maier  
35-02-28  
28 cm / 11"

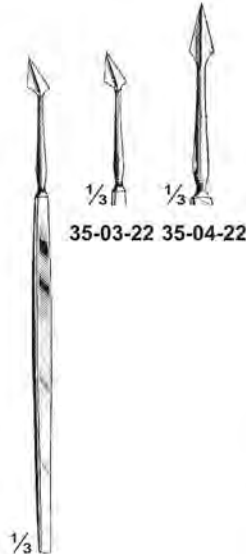

Ulrich  
35-03-22 & 35-04-22  
22 cm / 8 3/4"



Lancet-Duo  
35-08-12  
12.5 cm / 5"



Lancet  
35-09-13  
13 cm / 5"



Segond  
35-05-27  
27 cm / 10 1/2"  
Myomatome



35-06-23  
23 cm / 9"  
Cone knife



Ayre  
35-07-23  
23.5 cm / 9 1/4"  
Cone knife

**Seziermesser ; Cuchillos para autopsia  
Autopsy Knives Coltelli autopsia  
Couteaux à autopsie ; Facas autópsia**



1/2  
Virchow  
36-01-17  
17 cm / 6 3/4"



1/2  
Virchow  
36-02-19  
19 cm / 7 1/2"



1/2  
36-03-19  
19 cm / 7 1/2"



1/2  
Virchow  
36-04-24  
24 cm / 9 1/2"



1/2  
Virchow  
36-05-21  
21 cm / 8 1/4"  
Plastic handle



1/2  
36-06-21  
21 cm / 8 1/4"  
Plastic handle



1/2  
Virchow  
36-07-24  
24 cm / 9 1/2"  
Plastic handle



1/2  
36-08-24  
24 cm / 9 1/2"



1/2  
Virchow  
36-09-21  
21.5 cm / 8 1/2"



**Seziermesser ; Cuchillos para autopsia  
Autopsy Knives Coltelli autopsia  
Couteaux à autopsie ; Facas autópsia**



$\frac{1}{2}$   
**37-01-23**  
23 cm / 9"  
Plastic handle



$\frac{1}{2}$   
**37-02-25**  
25 cm / 10"



$\frac{1}{4}$   
**37-03-17**  
17.5 cm / 7"  
Plastic handle



$\frac{1}{4}$   
**37-04-17**  
17.5 cm / 7"



$\frac{1}{4}$   
Langenbeck  
**37-05-17 To 37-07-17**  
17.5 cm / 7"



$\frac{1}{4}$   
**37-05-17**



$\frac{1}{4}$   
**37-06-17**



$\frac{1}{4}$   
**37-07-17**



Seziermesser ; Cuchillos para autopsia  
Autopsy Knives Coltelli autopsia  
Couteaux à autopsie ; Facas autópsia



1/2  
Virchow  
38-01-17  
17 cm / 6 3/4"  
Plastic handle



1/4  
Nelaton  
38-02-14  
14.5 cm / 5 3/4"



1/4  
Nelaton  
38-03-14  
14.5 cm / 5 3/4"

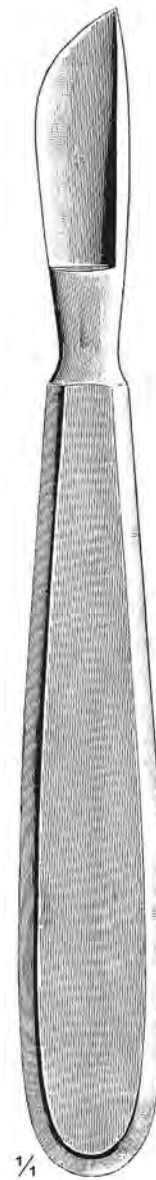

1/4  
Nelaton  
38-04-15  
15 cm / 6"



1/4  
Pott  
38-05-16  
16.5 cm / 6 1/2"

**Seziermesser ; Cuchillos para autopsia  
Autopsy Knives Coltelli autopsia  
Couteaux à autopsie ; Facas autópsia**







**Seziermesser ; Cuchillos para autopsia  
Autopsy Knifes Coltelli autopsia  
Couteaux à autopsie ; Facas autópsia**

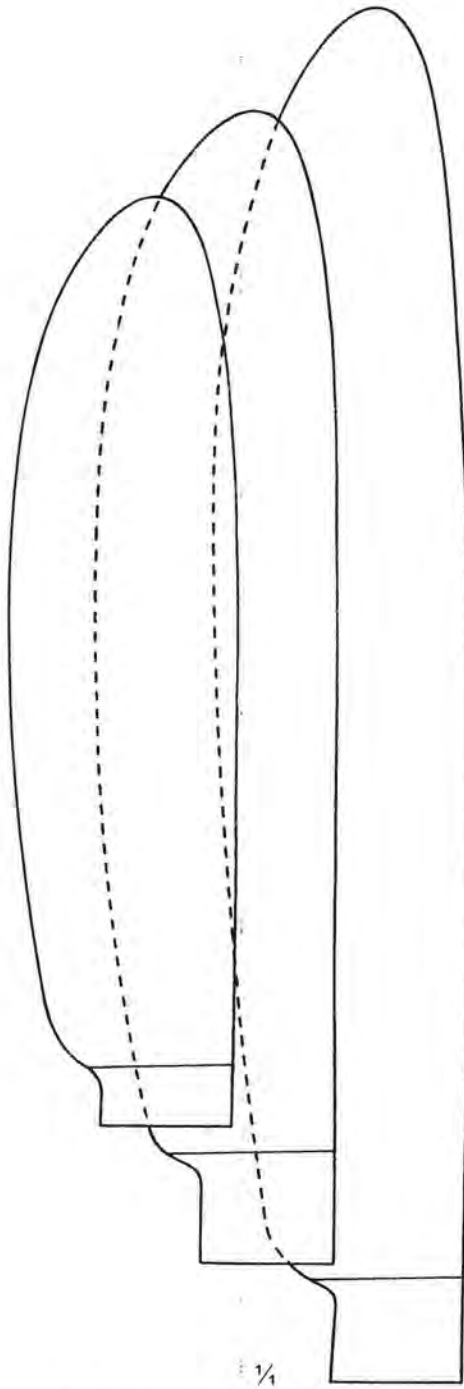

Stainless Handle	Blade Size	Plastic Handle
40-01-11	11.5 cm / 4½"	40-04-11
40-02-13	13.5 cm / 5¼"	40-05-13
40-03-16	16.5 cm / 6½"	40-06-16



Walb  
40-01-11 To 40-06-16



Virchow  
40-07-28  
28 cm / 11"  
Blade size  
16 cm / 6¼"



Virchow  
40-08-32  
32 cm / 12¾"  
Blade size  
20 cm / 8"

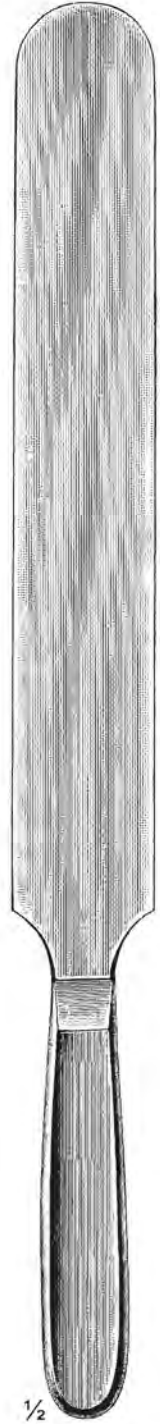

Virchow  
40-09-36  
36 cm / 14½"  
Blade size  
24 cm / 9½"

**Amputationsmesser ; Cuchillos para amputación  
Amputation Knives ; Coltelli taglio  
Couteaux à amputation ; Facas amputação**



1/2

Liston

	Blade size
41-01-12	12 cm / 4 3/4"
41-02-13	13 cm / 5 1/8"
41-03-14	14 cm / 5 1/2"
41-04-15	15 cm / 6"
41-05-16	16 cm / 6 1/4"
41-06-17	17 cm / 6 3/4"
41-07-18	18 cm / 7"
41-08-19	19 cm / 7 1/2"
41-09-20	20 cm / 8"
41-10-21	21 cm / 8 1/4"
41-11-22	22 cm / 8 3/4"
41-12-23	23 cm / 9"



1/2

Liston

	Blade size
41-13-12	12 cm / 4 3/4"
41-14-13	13 cm / 5 1/8"
41-15-14	14 cm / 5 1/2"
41-16-15	15 cm / 6"
41-17-16	16 cm / 6 1/4"
41-18-17	17 cm / 6 3/4"
41-19-18	18 cm / 7"
41-20-19	19 cm / 7 1/2"
41-21-20	20 cm / 8"
41-22-21	21 cm / 8 1/4"
41-23-22	22 cm / 8 3/4"
41-24-23	23 cm / 9"



1/2

Catlin

	Blade size
41-25-12	12 cm / 4 3/4"
41-26-13	13 cm / 5 1/8"
41-27-14	14 cm / 5 1/2"
41-28-15	15 cm / 6"
41-29-16	16 cm / 6 1/4"
41-30-17	17 cm / 6 3/4"
41-31-18	18 cm / 7"
41-32-19	19 cm / 7 1/2"
41-33-20	20 cm / 8"
41-34-21	21 cm / 8 1/4"
41-35-22	22 cm / 8 3/4"
41-36-23	23 cm / 9"



1/2

Collin

	Blade size
41-37-12	12 cm / 4 3/4"
41-38-13	13 cm / 5 1/8"
41-39-14	14 cm / 5 1/2"
41-40-15	15 cm / 6"
41-41-16	16 cm / 6 1/4"
41-42-17	17 cm / 6 3/4"
41-43-18	18 cm / 7"
41-44-19	19 cm / 7 1/2"
41-45-20	20 cm / 8"
41-46-21	21 cm / 8 1/4"
41-47-22	22 cm / 8 3/4"
41-48-23	23 cm / 9"

Rasiermesser ; Navaja  
 Razor Knives ; Rasoio  
 Razoirs ; Navalha

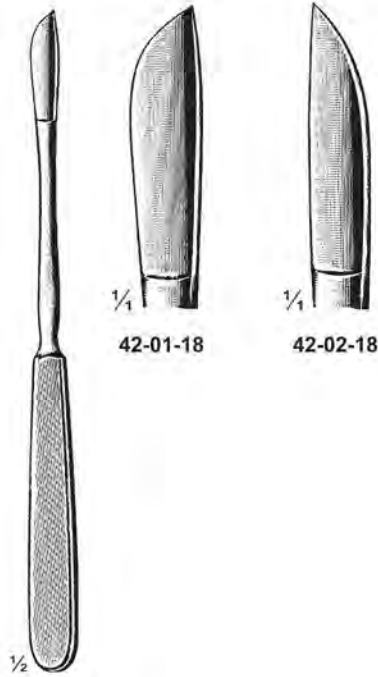

Simon  
 42-01-18 & 42-02-18  
 18 cm / 7"



Collin  
 Blade size  
 42-03-12 12 cm / 4 3/4"  
 42-04-15 15 cm / 6"  
 42-05-17 17 cm / 6 3/4"



Langenbeck  
 Blade size  
 42-06-13 13 cm / 5 1/8"  
 42-07-15 15 cm / 6"  
 42-08-18 18 cm / 7"  
 42-09-20 20 cm / 8"

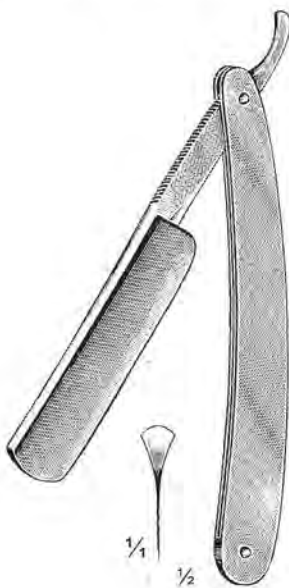

42-10-07  
 Blade size  
 7.5 cm / 3"  
 Both sides concave

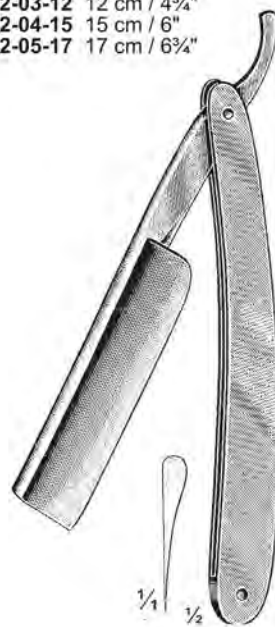

42-11-08  
 Blade size  
 8 cm / 3 1/4"  
 One side concave

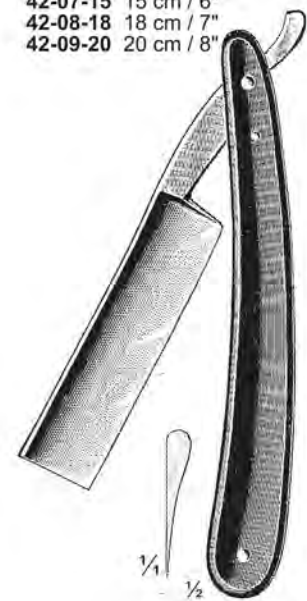

42-12-08  
 Blade size  
 8 cm / 3 1/4"  
 One side concave

**Dermatome ; Dermátomo  
Skin Grafting Knives ; Dermatomo  
Dermatomes ; Dermátomo**



1/2

Schink  
**43-01-30**  
30 cm / 12"



1/2

**43-02-10**  
10 cm / 4"  
Spare blade

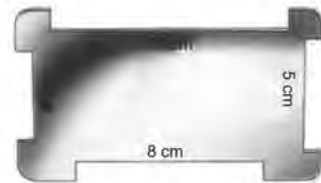

**43-03-00**  
Skin straightening plate only



1/2

Thiersch  
**43-04-20**  
20 cm / 8"



1/2

Thiersch  
**43-05-20**  
20.5 cm / 8 1/4"

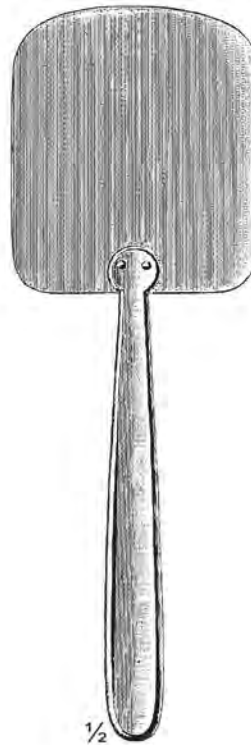

1/2

Mayo  
**43-06-20**  
20 cm / 8"



1/2

Rehn  
**43-07-23**  
23.5 cm / 9 1/4"

**Feine Präparierscheren ; Tijeras delicatas de disección  
Delicate Scissors ; Forbici delicati per dissezione  
Ciseaux délicates à dissection ; Tesouras delicada para disseção**



44-01-09

44-02-09

Sh/Sh  
44-03-11  
11 cm / 4¼"

Sh/Bl  
44-05-11  
11 cm / 4¼"

Sh/Sh  
44-07-11  
11 cm / 4¼"

Sh/Bl  
44-09-11  
11 cm / 4¼"

Iris  
44-01-09 & 44-02-09  
9 cm / 3½"

Iris  
44-03-11 To 44-10-11

Sh/Sh  
44-11-11  
11 cm / 4¼"

Sh/Sh  
44-13-11  
11 cm / 4¼"

Sh/Bl  
44-15-11  
11 cm / 4¼"

Sh/Bl  
44-17-11  
11 cm / 4¼"

Sh/Sh, Angular  
44-19-11  
11 cm / 4¼"

Sh/Sh, Sideways Cur  
44-21-11  
11 cm / 4¼"

Iris  
44-11-11 To 44-22-11

Feine Präparierscheren ; Tijeras delicatas de disección  
 Delicate Scissors ; Forbici delicati per dissezione  
 Ciseaux délicates à dissection ; Tesouras delicada para disseccão

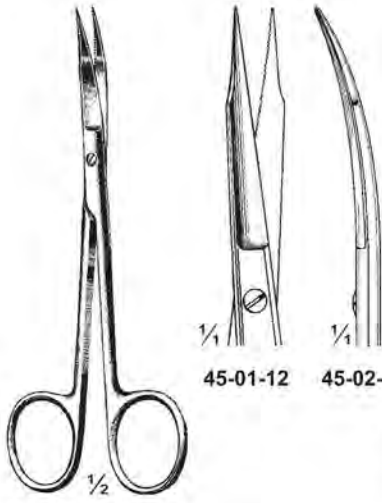

Goldman-Fox  
 45-01-12 & 45-02-12  
 12.5 cm / 5"  
 One blade serrated



Stevens  
 45-03-11 To 45-06-11  
 11 cm / 4 1/4"

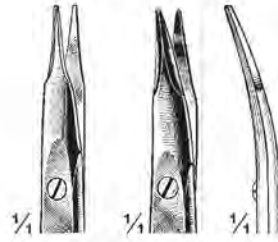

45-05-11 45-06-11  
 45-09-11 45-10-11  
 BI/BI BI/BI

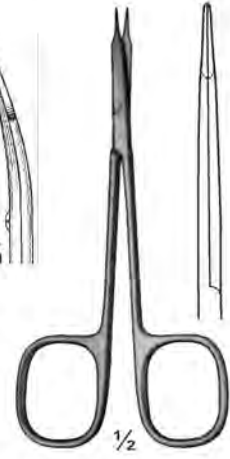

Stevens  
 45-07-11 To 45-10-11  
 11.5 cm / 4 1/2"

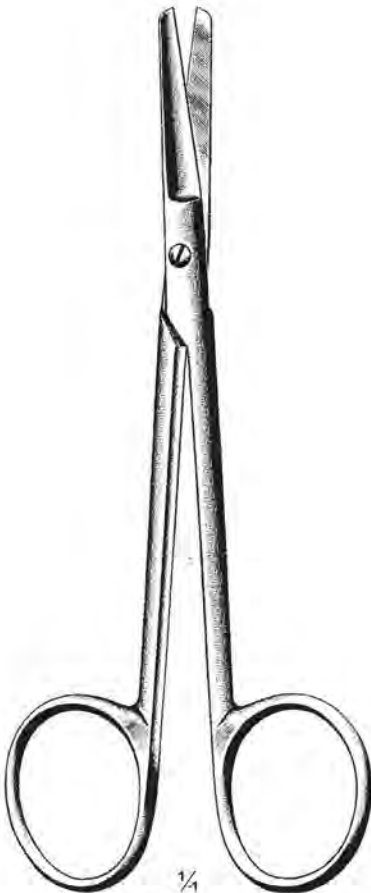

45-11-12  
 12 cm / 4 3/4"

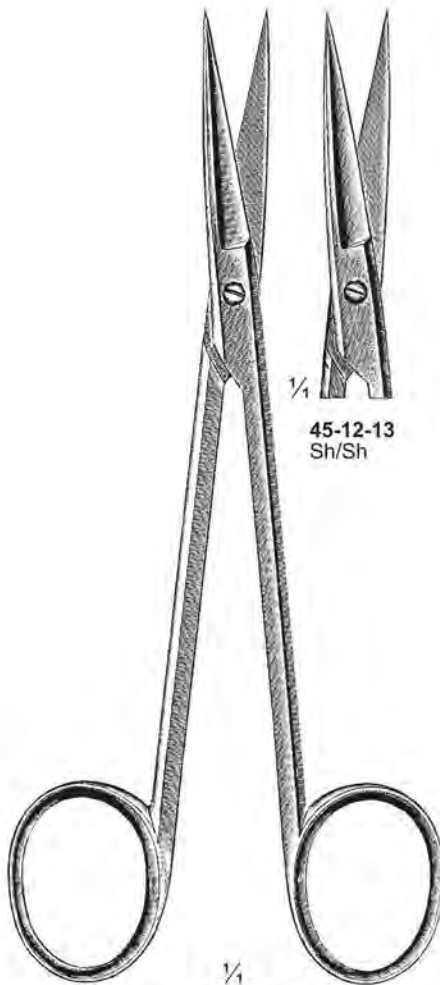

45-12-13 To 45-15-13  
 13 cm / 5 1/4"

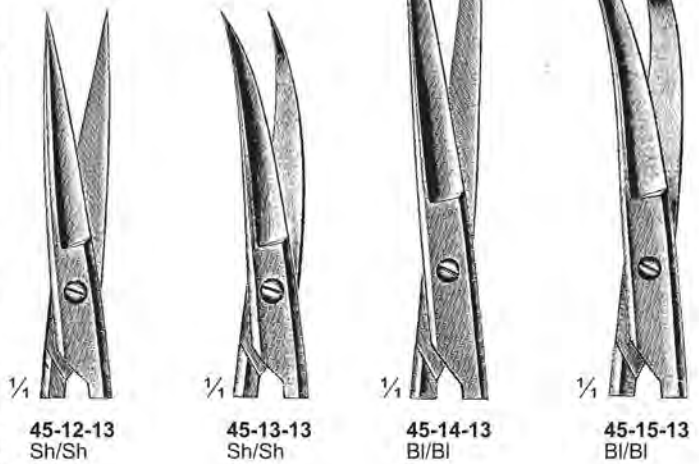

45-12-13 45-13-13 45-14-13 45-15-13  
 Sh/Sh Sh/Sh BI/BI BI/BI

**Feine Präparierscheren ; Tijeras delicatas de disección  
Delicate Scissors ; Forbici delicati per dissezione  
Ciseaux délicates à dissection ; Tesouras delicada para disseção**



Joseph  
46-01-14  
14 cm / 5½"



Joseph  
46-02-14  
14 cm / 5½"

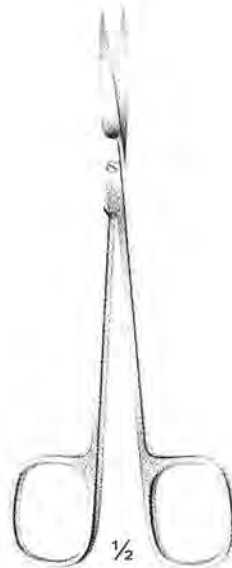

Joseph  
46-03-15 & 46-04-15  
15 cm / 6"



46-03-15



46-04-15

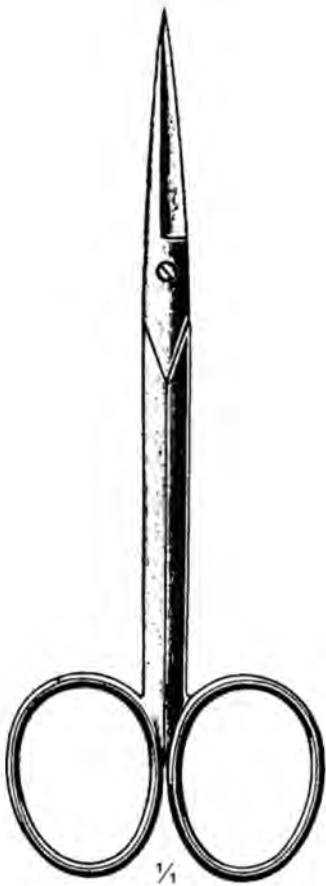

Iris  
46-05-11 11.5 cm / 4½" Str  
46-06-11 11.5 cm / 4½" Cur



Dissecting  
46-07-11 & 46-08-11  
11 cm / 4¼"



46-07-11

46-08-11

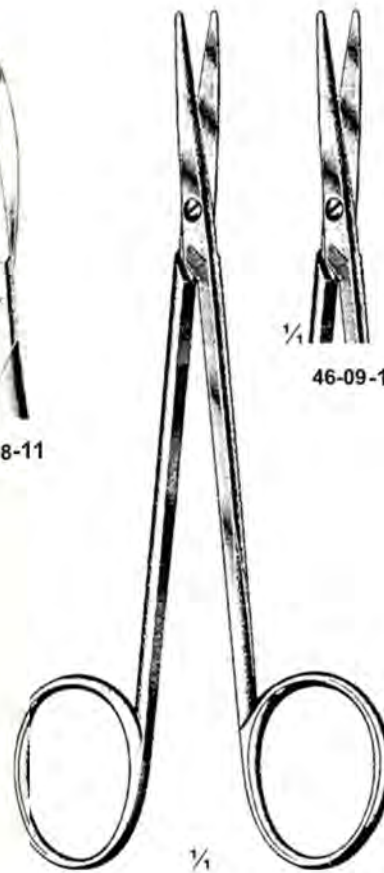

46-09 & 46-10  
11.5 cm / 4½"

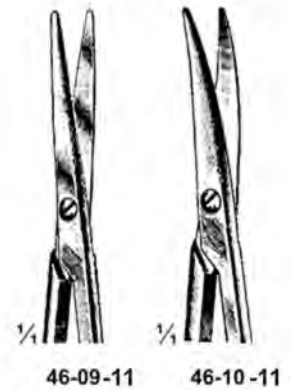

46-09-11

46-10-11

Feine Präparierscheren ; Tijeras delicatas de disección  
 Delicate Scissors ; Forbici delicati per dissezione  
 Ciseaux délicates à dissection ; Tesouras delicada para disseção

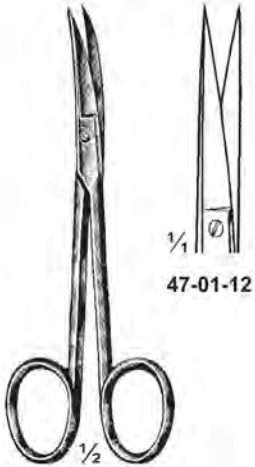

Wagner  
 47-01-12 & 47-02-12  
 12 cm / 4¾"

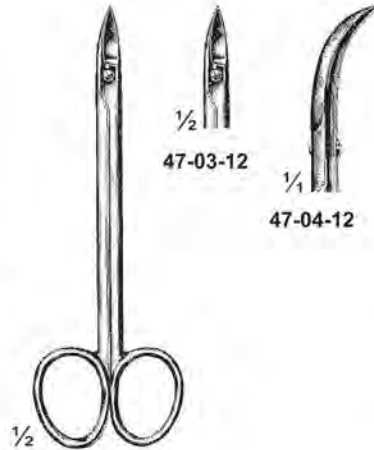

Quinby  
 47-03-12 & 47-04-12  
 12 cm / 4¾"



Neumann  
 47-05-12  
 12 cm / 4¾"

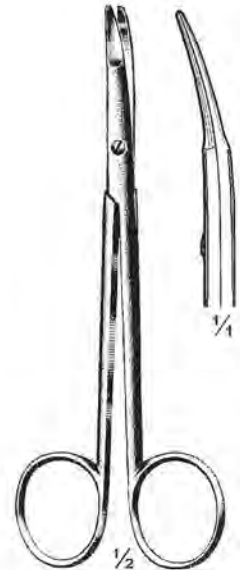

Kilner  
 47-06-12 12 cm / 4¾"  
 47-07-12 15 cm / 6"



Maunoir  
 47-08-11  
 11.5 cm / 4½"  
 Sh/Probe

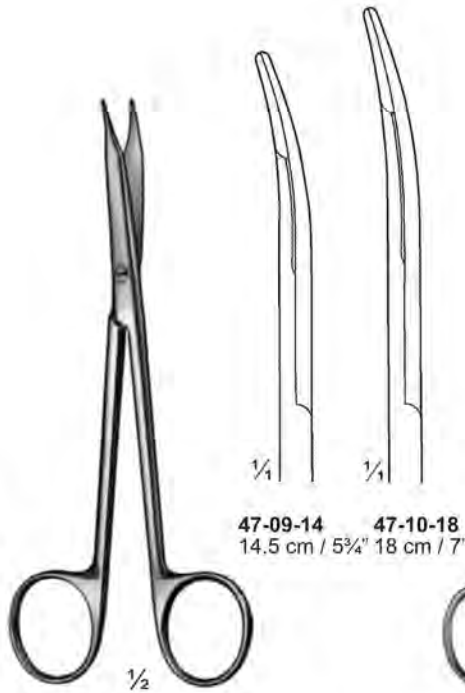

Reynolds  
 47-09-14 & 47-10-18

47-09-14 14.5 cm / 5¾"  
 47-10-18 18 cm / 7"

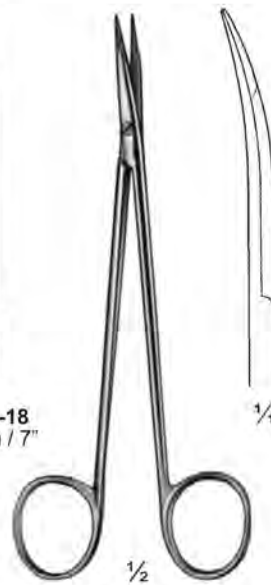

Jameson  
 47-11-15  
 15 cm / 6"



Reynolds-Jameson  
 47-12-14  
 14 cm / 5½"



Feine Präparierscheren ; Tijeras delicatas de disección  
 Delicate Scissors ; Forbici delicati per dissezione  
 Ciseaux délicates à dissection ; Tesouras delicada para disseção

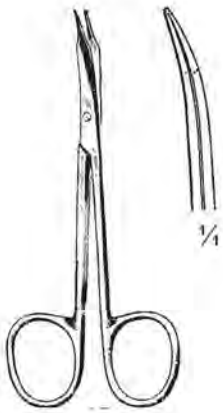

Enucleation  
 48-01-11  
 11 cm / 4 1/4"

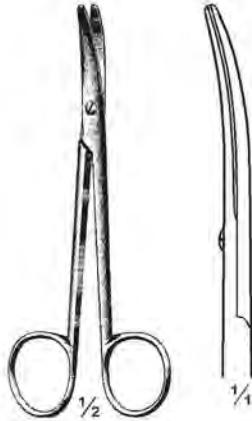

Micro Stevens  
 48-02-11 11 cm / 4 1/4" Str  
 48-03-11 11 cm / 4 1/4" Cur

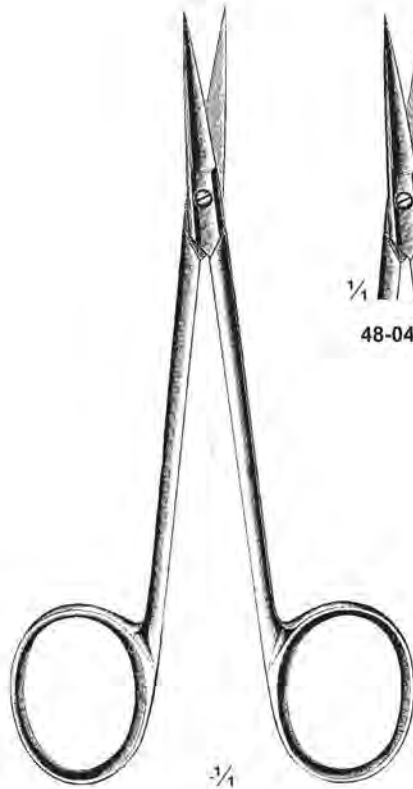

Iris  
 48-04-11 & 48-05-11  
 11 cm / 4 1/4"



1/4  
 48-04-11



1/4  
 48-05-11

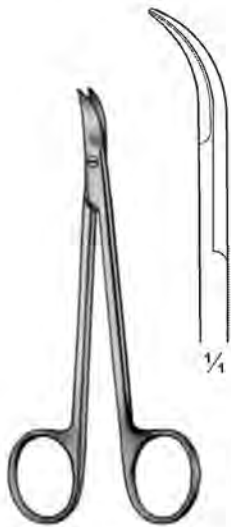

Chadwick  
 48-06-11  
 11.5 cm / 4 1/2"

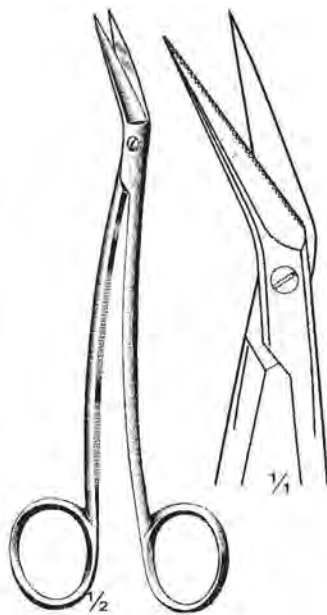

Locklin  
 48-07-16  
 16 cm / 6 1/4"  
 One blade serrated



Kelly  
 48-08-14 To 48-13-18

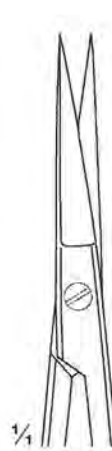

1/4  
 48-08-14  
 14.5 cm / 5 3/4"  
 48-09-16  
 16 cm / 6 1/4"



1/4  
 48-10-18  
 18 cm / 7"



1/4  
 48-11-14  
 14.5 cm / 5 3/4"  
 48-12-16  
 16 cm / 6 1/4"



1/4  
 48-13-18  
 18 cm / 7"

Feine Präparierscheren ; Tijeras delicatas de disección  
 Delicate Scissors ; Forbici delicati per dissezione  
 Ciseaux délicates à dissection ; Tesouras delicada para disseccão

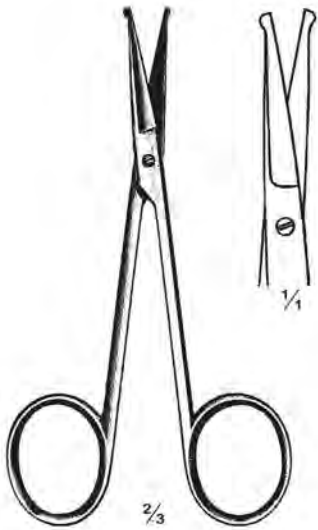

49-01-10  
 10.5 cm / 4 1/8"

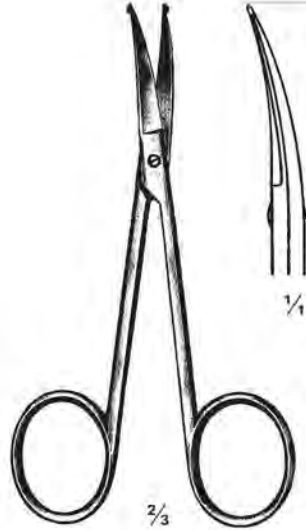

49-02-10  
 10.5 cm / 4 1/8"

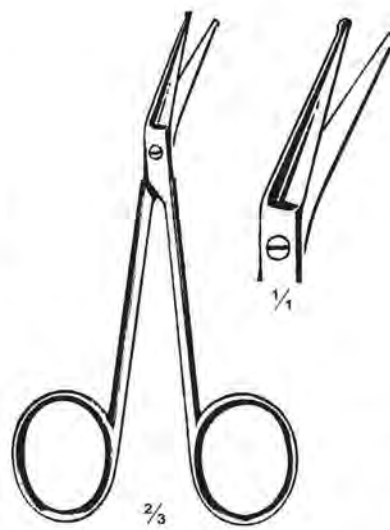

49-03-10  
 10.5 cm / 4 1/8"

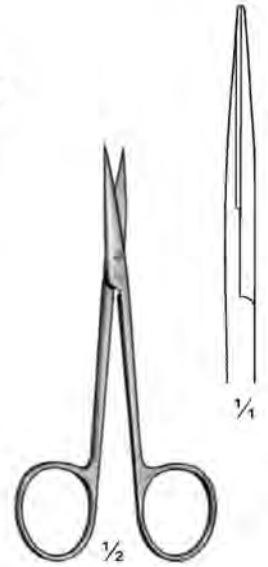

Kilner  
 49-04-11  
 11.5 cm / 4 1/2"

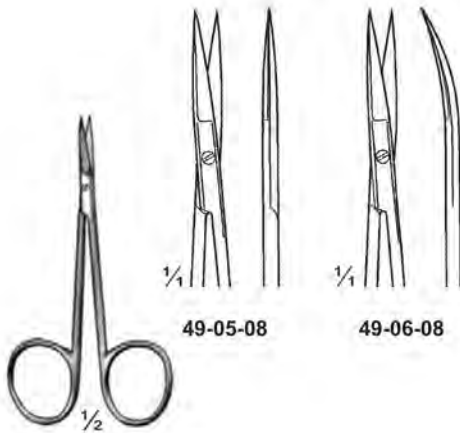

49-05-08 & 49-06-08  
 8 cm / 3 1/4"

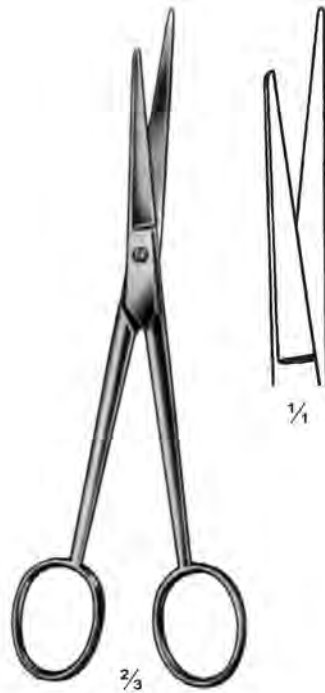

49-07-14  
 14.5 cm / 5 3/4"  
 Without probe



49-08-14  
 14.5 cm / 5 3/4"  
 Sh/Probe

Feine Präparierscheren ; Tijeras delicatas de disección  
 Delicate Scissors ; Forbici delicati per dissezione  
 Ciseaux délicates à dissection ; Tesouras delicada para disseção

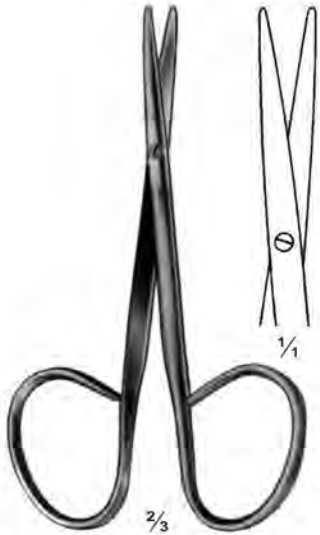

50-01-10  
10 cm / 4"



50-02-10  
10 cm / 4"

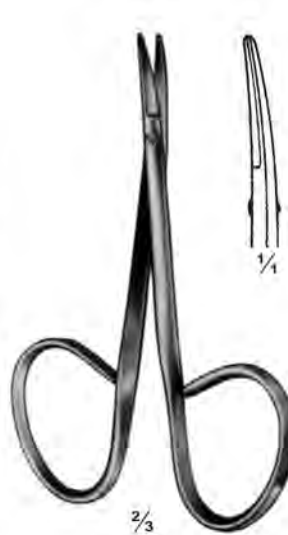

50-03-09  
9.5 cm / 3 3/4"

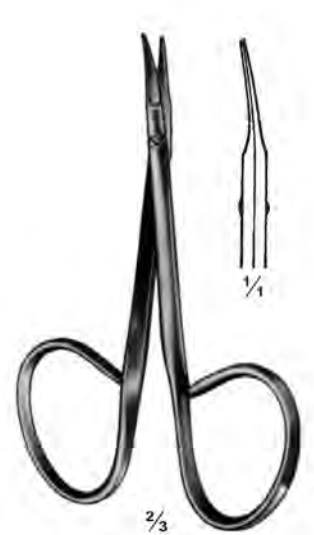

50-04-09  
9.5 cm / 3 3/4"



Stevens  
50-05-10  
10 cm / 4"



Stevens  
50-06-10  
10 cm / 4"



Stevens  
50-07-10  
10 cm / 4"

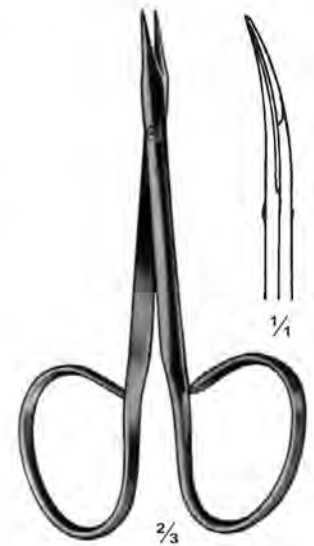

Stevens  
50-08-10  
10 cm / 4"

Feine Präparierscheren ; Tijeras delicatas de disección  
 Delicate Scissors ; Forbici delicati per dissezione  
 Ciseaux délicates à dissection ; Tesouras delicada para disseção

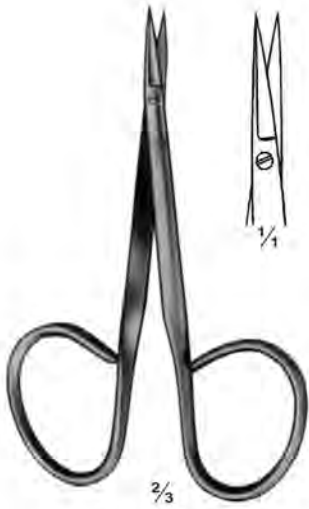

51-01-09  
 9.5 cm / 3¾"

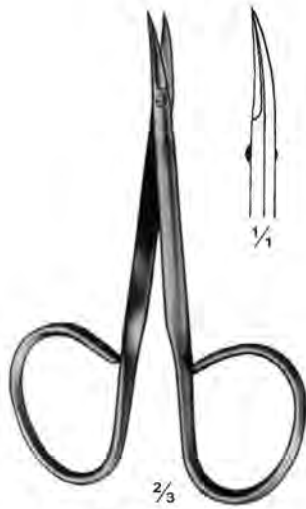

51-02-09  
 9.5 cm / 3¾"



51-03-09  
 9.5 cm / 3¾"

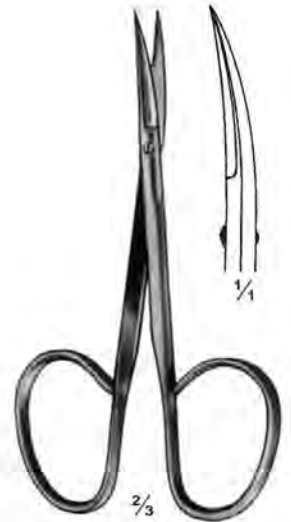

51-04-09  
 9.5 cm / 3¾"



Knapp  
 51-05-12  
 12 cm / 4¾"



Knapp  
 51-06-12  
 12 cm / 4¾"



Knapp  
 51-07-12  
 12 cm / 4¾"



Knapp  
 51-08-12  
 12 cm / 4¾"

Feine Präparierscheren ; Tijeras delicatas de disección  
 Delicate Scissors ; Forbici delicati per dissezione  
 Ciseaux délicates à dissection ; Tesouras delicada para disseção

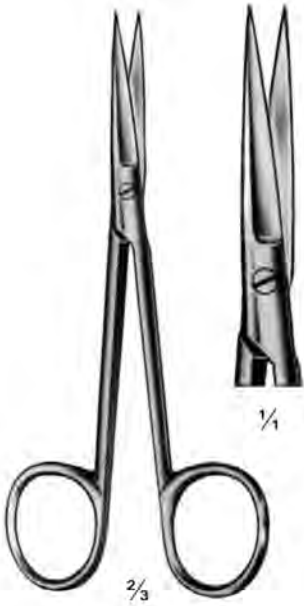

Wagner  
 52-01-12  
 12 cm / 4 3/4"

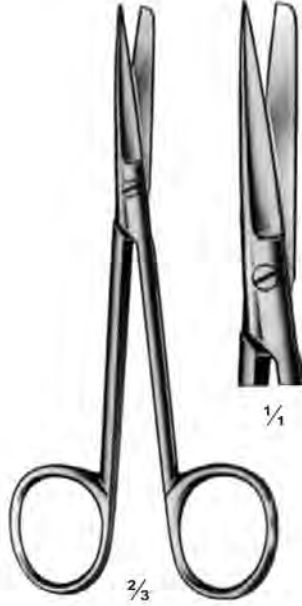

Wagner  
 52-02-12  
 12 cm / 4 3/4"

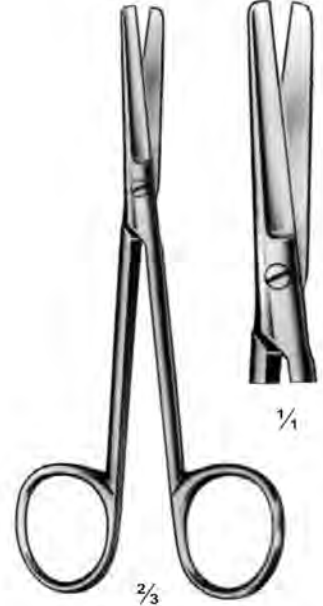

Wagner  
 52-03-12  
 12 cm / 4 3/4"



Wagner  
 52-04-12  
 12 cm / 4 3/4"



Wagner  
 52-05-12  
 12 cm / 4 3/4"



Wagner  
 52-06-12  
 12 cm / 4 3/4"

Ligaturscheren ; Tijeras para ligaduras  
 Ligature Scissors ; Forbici per legatura  
 Ciseaux à ligatures ; Tesouras para ligaduras



Schoemaker-Loth  
 53-01-13  
 13 cm / 5 1/4"



53-02-12  
 12 cm / 4 3/4"  
 One blade serrated



Eiselsboerg  
 53-03-11  
 11 cm / 4 1/4"



Harvey  
 53-04-12  
 12.5 cm / 5"  
 Both blades serrated

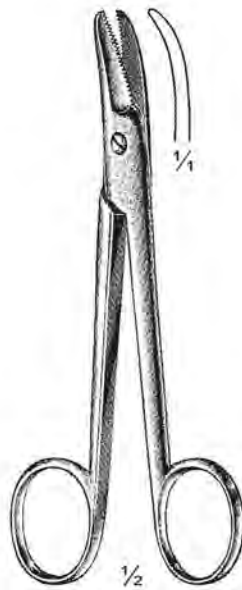

53-05-15  
 15.5 cm / 6 1/8"  
 Both blade serrated

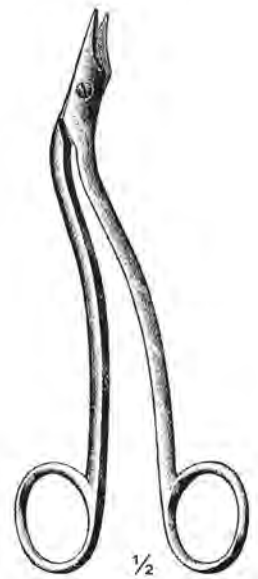

Heath  
 53-06-15  
 15 cm / 6"  
 One blade serrated

**Ligaturscheren ; Tijeras para ligaduras  
Ligature Scissors ; Forbici per legatura  
Ciseaux à ligatures ; Tesouras para ligaduras**



54-01-09 9 cm / 3½"  
54-02-13 13 cm / 5½"



Spencer  
54-03-13  
13 cm / 5½"



Buck  
54-04-13  
13.5 cm / 5¼"



Littauer  
54-05-14  
14 cm / 5½"



Northbent  
54-06-09 9 cm / 3½"  
54-07-13 13 cm / 5½"



54-08-11  
11 cm / 4¼"  
One blade serrated

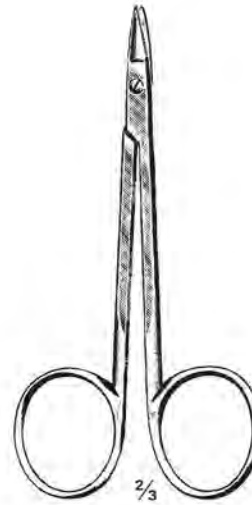

Schuknecht  
54-09-10  
10 cm / 4"  
One blade serrated



Strack  
54-10-10  
10 cm / 4"

**Ligaturscheren ; Tijeras para ligaduras  
Ligature Scissors ; Forbici per legatura  
Ciseaux à ligatures ; Tesouras para ligaduras**

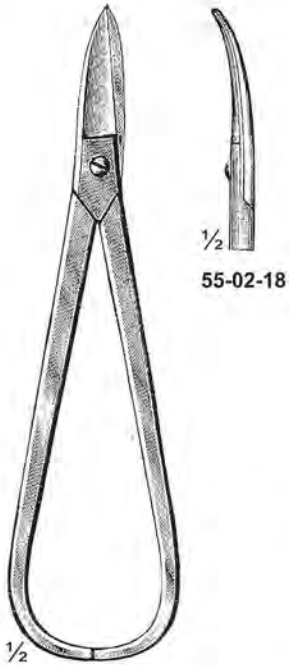

55-01-18 Str  
55-01-18 & 55-02-18  
18 cm / 7"  
Wire and plate cutter

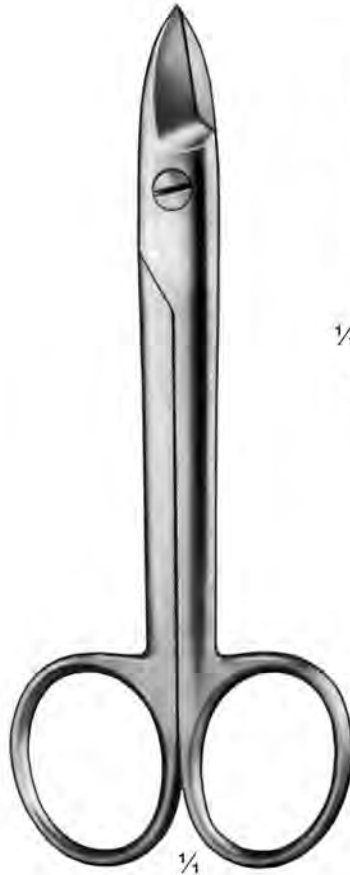

Beebee  
55-03-11 To 55-06-11  
11.5 cm / 4½"  
Broad blades



55-03-11  
Sh/Sh



55-04-11  
Sh/Sh



55-05-11  
Sh/Sh  
One blade  
serrated



55-06-11  
Sh/Sh  
One blade  
serrated



55-11-12  
12.5 cm / 5"



Beebee  
55-07 & 55-08  
12.5 cm / 5"



55-07-12  
Sh/Sh

55-08-12  
Sh/Sh

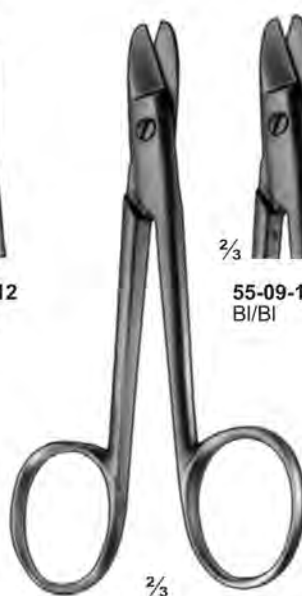

Beebee  
55-09 & 55-10  
12.5 cm / 5"



55-09-12  
Bl/Bl



55-10-12  
Bl/Bl





**Chirurgische Scheren ; Tijeras para cirugía  
Operating Scissors ; Forbici per chirurgia  
Ciseaux à chirurgie ; Tesouras para cirúgica**



Sh/Sh  
**56-01-10** 10 cm / 4"  
**56-02-11** 11.5 cm / 4½"  
**56-03-12** 12.5 cm / 5"  
**56-04-14** 14 cm / 5½"  
**56-05-14** 14.5 cm / 5¾"  
**56-06-15** 15 cm / 6"  
**56-07-17** 17 cm / 6¾"  
**56-08-18** 18 cm / 7"  
**56-09-20** 20 cm / 8"



Sh/BI  
**56-10-10** 10 cm / 4"  
**56-11-11** 11.5 cm / 4½"  
**56-12-12** 12.5 cm / 5"  
**56-13-14** 14 cm / 5½"  
**56-14-14** 14.5 cm / 5¾"  
**56-15-15** 15 cm / 6"  
**56-16-17** 17 cm / 6¾"  
**56-17-18** 18 cm / 7"  
**56-18-20** 20 cm / 8"

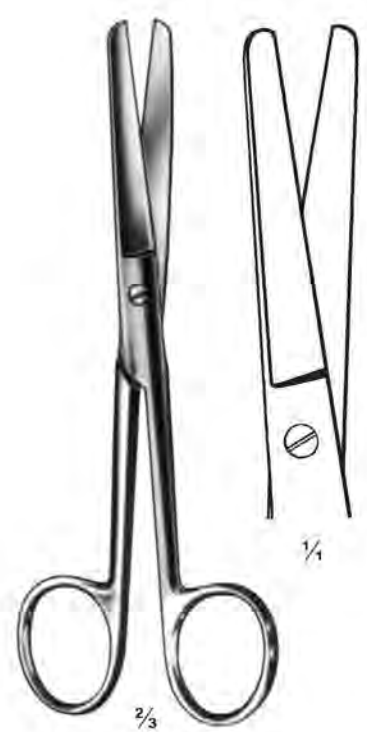

BI/BI  
**56-19-10** 10 cm / 4"  
**56-20-11** 11.5 cm / 4½"  
**56-21-12** 12.5 cm / 5"  
**56-22-14** 14 cm / 5½"  
**56-23-14** 14.5 cm / 5¾"  
**56-24-15** 15 cm / 6"  
**56-25-17** 17 cm / 6¾"  
**56-26-18** 18 cm / 7"  
**56-27-20** 20 cm / 8"

**Chirurgische Scheren ; Tijeras para cirugía  
Operating Scissors ; Forbici per chirurgia  
Ciseaux à chirurgie ; Tesouras para cirúgica**



Sh/Sh  
**57-01-10** 10 cm / 4"  
**57-02-11** 11.5 cm / 4½"  
**57-03-12** 12.5 cm / 5"  
**57-04-14** 14 cm / 5½"  
**57-05-14** 14.5 cm / 5¾"  
**57-06-15** 15 cm / 6"  
**57-07-17** 17 cm / 6¾"  
**57-08-18** 18 cm / 7"  
**57-09-20** 20 cm / 8"



Sh/BI  
**57-10-10** 10 cm / 4"  
**57-11-11** 11.5 cm / 4½"  
**57-12-12** 12.5 cm / 5"  
**57-13-14** 14 cm / 5½"  
**57-14-14** 14.5 cm / 5¾"  
**57-15-15** 15 cm / 6"  
**57-16-17** 17 cm / 6¾"  
**57-17-18** 18 cm / 7"  
**57-18-20** 20 cm / 8"

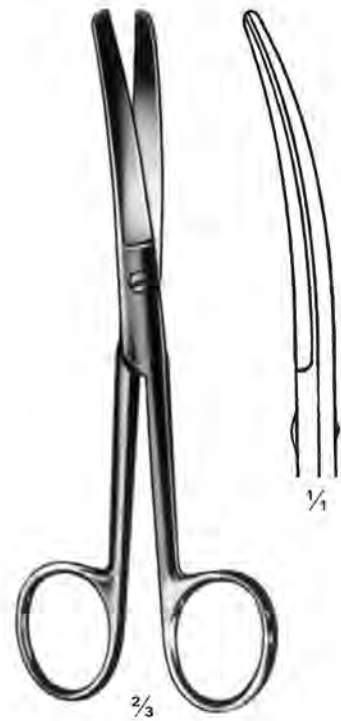

BI/BI  
**57-19-10** 10 cm / 4"  
**57-20-11** 11.5 cm / 4½"  
**57-21-12** 12.5 cm / 5"  
**57-22-14** 14 cm / 5½"  
**57-23-14** 14.5 cm / 5¾"  
**57-24-15** 15 cm / 6"  
**57-25-17** 17 cm / 6¾"  
**57-26-18** 18 cm / 7"  
**57-27-20** 20 cm / 8"

**Chirurgische Scheren ; Tijeras para cirugía  
Operating Scissors ; Forbici per chirurgia  
Ciseaux à chirurgie ; Tesouras para cirúgica**



Standard  
Sh/Sh  
58-01-10 10 cm / 4"  
58-02-11 11.5 cm / 4½"  
58-03-12 12.5 cm / 5"  
58-04-14 14 cm / 5½"  
58-05-14 14.5 cm / 5¾"  
58-06-15 15 cm / 6"  
58-07-17 17 cm / 6¾"  
58-08-18 18 cm / 7"  
58-09-20 20 cm / 8"



Standard  
Sh/BI  
58-10-10 10 cm / 4"  
58-11-11 11.5 cm / 4½"  
58-12-12 12.5 cm / 5"  
58-13-14 14 cm / 5½"  
58-14-14 14.5 cm / 5¾"  
58-15-15 15 cm / 6"  
58-16-17 17 cm / 6¾"  
58-17-18 18 cm / 7"  
58-18-20 20 cm / 8"



Standard  
BI/BI  
58-19-10 10 cm / 4"  
58-20-11 11.5 cm / 4½"  
58-21-12 12.5 cm / 5"  
58-22-14 14 cm / 5½"  
58-23-14 14.5 cm / 5¾"  
58-24-15 15 cm / 6"  
58-25-17 17 cm / 6¾"  
58-26-18 18 cm / 7"  
58-27-20 20 cm / 8"



Standard  
Sh/Sh  
58-28-10 10 cm / 4"  
58-29-11 11.5 cm / 4½"  
58-30-12 12.5 cm / 5"  
58-31-14 14 cm / 5½"  
58-32-14 14.5 cm / 5¾"  
58-33-15 15 cm / 6"  
58-34-17 17 cm / 6¾"  
58-35-18 18 cm / 7"  
58-36-20 20 cm / 8"



Standard  
Sh/BI  
58-37-10 10 cm / 4"  
58-38-11 11.5 cm / 4½"  
58-39-12 12.5 cm / 5"  
58-40-14 14 cm / 5½"  
58-41-14 14.5 cm / 5¾"  
58-42-15 15 cm / 6"  
58-43-17 17 cm / 6¾"  
58-44-18 18 cm / 7"  
58-45-20 20 cm / 8"



Standard  
BI/BI  
58-46-10 10 cm / 4"  
58-47-11 11.5 cm / 4½"  
58-48-12 12.5 cm / 5"  
58-49-14 14 cm / 5½"  
58-50-14 14.5 cm / 5¾"  
58-51-15 15 cm / 6"  
58-52-17 17 cm / 6¾"  
58-53-18 18 cm / 7"  
58-54-20 20 cm / 8"

**Chirurgische Scheren ; Tijeras para cirugía  
Operating Scissors ; Forbici per chirurgia  
Ciseaux à chirurgie ; Tesouras para cirúgica**



59-01-13 13 cm / 5 1/8"  
59-02-14 14.5 cm / 5 3/4"



59-03-13 13 cm / 5 1/8"  
59-04-14 14.5 cm / 5 3/4"



59-05-13 13 cm / 5 1/8"  
59-06-14 14.5 cm / 5 3/4"



House-Toennis  
59-07-18  
18 cm / 7"



59-08-13 13 cm / 5 1/8"  
59-09-14 14.5 cm / 5 3/4"



59-10-13 13 cm / 5 1/8"  
59-11-14 14.5 cm / 5 3/4"



59-12-13 13 cm / 5 1/8"  
59-13-14 14.5 cm / 5 3/4"

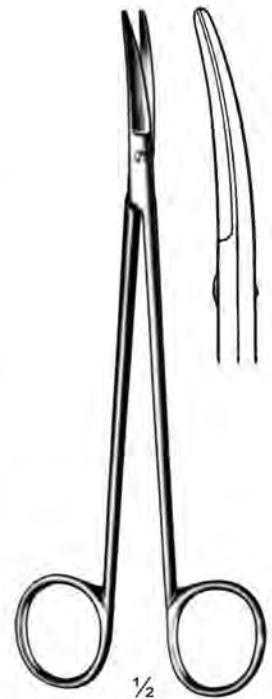

Toennis  
59-14-18  
18 cm / 7"

**Chirurgische Scheren ; Tijeras para cirugía  
Operating Scissors ; Forbici per chirurgia  
Ciseaux à chirurgie ; Tesouras para cirúgica**

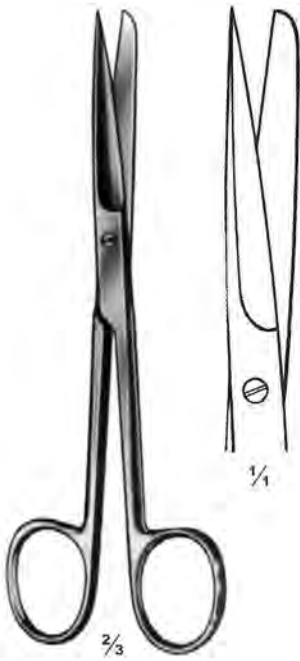

Deaver  
60-01-14  
14 cm / 5½"



Deaver  
60-02-14  
14 cm / 5½"



Deaver  
60-03-14  
14 cm / 5½"

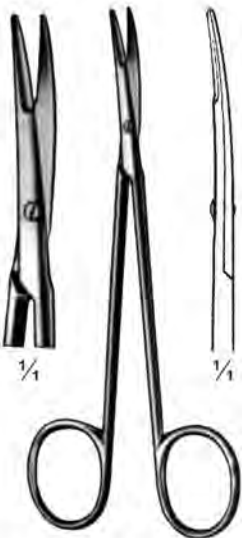

Shea  
60-04-12  
12 cm / 4¾"



Richter  
60-05-13 13 cm / 5⅛"  
60-06-14 14.5 cm / 5¾"

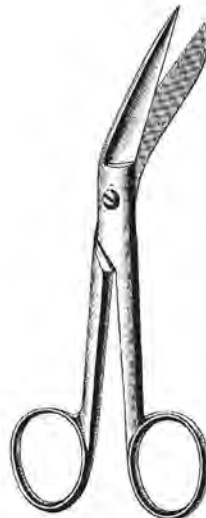

Richter  
60-07-13 13 cm / 5⅛"  
60-08-14 14.5 cm / 5¾"



Richter  
60-09-13 13 cm / 5⅛"  
60-10-14 14.5 cm / 5¾"

**Chirurgische Scheren  
Operating Scissors  
Ciseaux Chirurgicaux**



Mayo-Style  
61-01-15 15CM  
61-02-17 17CM  
61-03-18 18CM



1/2  
Mayo-Style  
61-04-15 15 cm  
61-05-17 17 cm  
61-06-18 18 cm



1/2  
Mayo-Style  
61-07-20 20CM  
61-08-23 23CM  
61-09-24 24CM  
61-10-25 25CM



1/2  
Mayo-Style  
61-11-20 20CM  
61-12-23 23CM  
61-13-24 24CM  
61-14-25 25CM



1/2  
Sh/Probe  
61-15-14 14 cm / 5 1/2"  
61-16-15 15 cm / 6"  
Sh/Probe

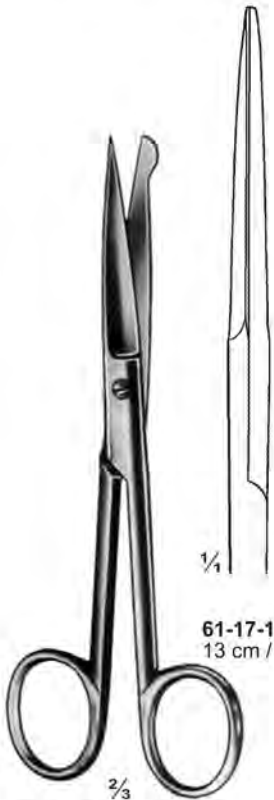

2/3  
61-17-13 To 61-19-16  
Sh/Probe

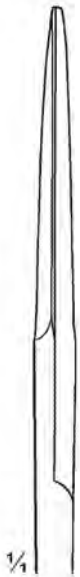

1/4  
61-17-13  
13 cm / 5 1/4"



1/4  
61-18-14  
14.5 cm / 5 3/4"



1/4  
61-19-16  
16.5 cm / 6 1/2"

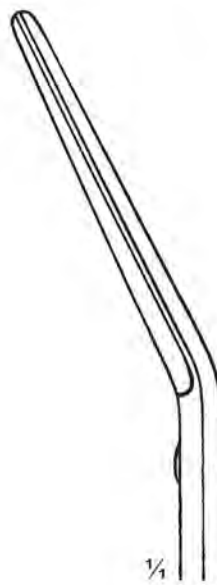

1/4



2/3  
Ferguson  
61-20-16  
16.5 cm / 6 1/2"

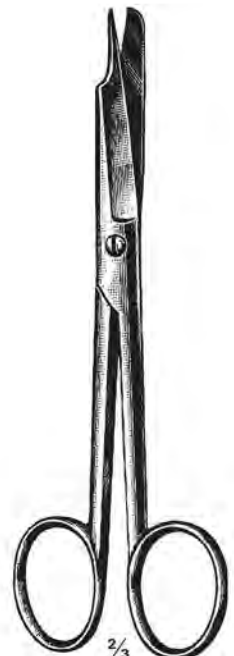

2/3  
61-21-13 13 cm / 5 1/8"  
61-22-15 15 cm / 6"

**Chirurgische Scheren  
Operating Scissors  
Ciseaux Chirurgicaux**

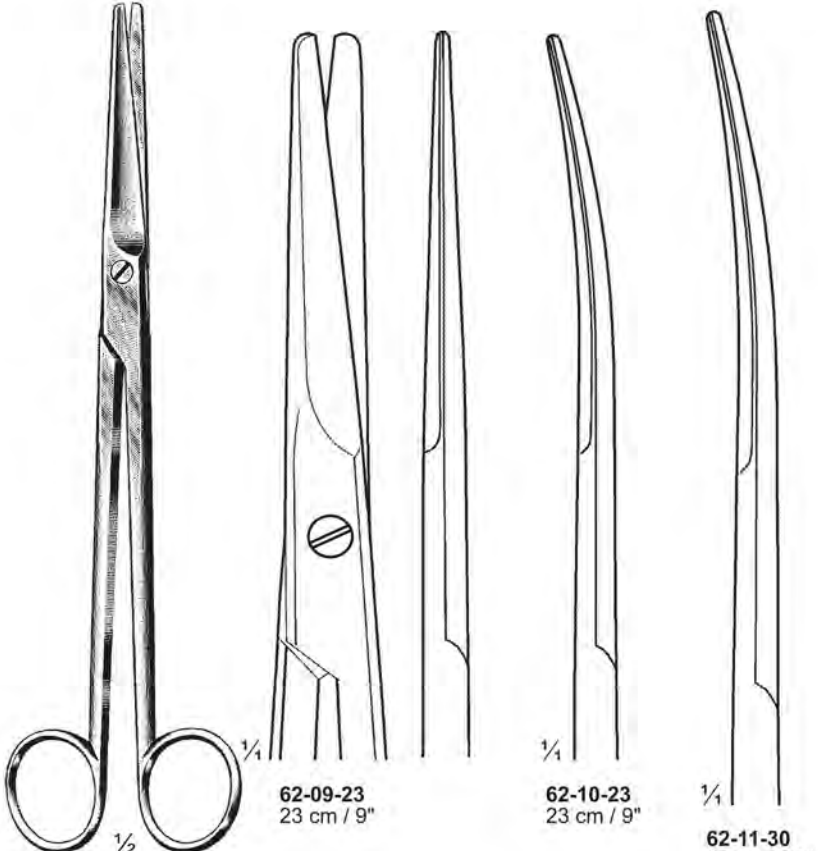
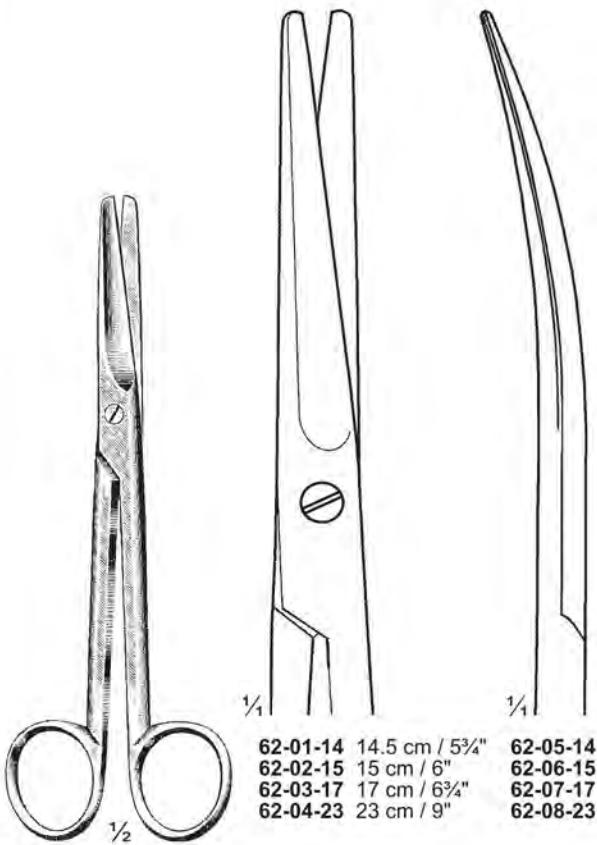

Mayo  
62-01-14 To 62-08-23

Mayo-Harrington  
62-09-23 To 62-11-30

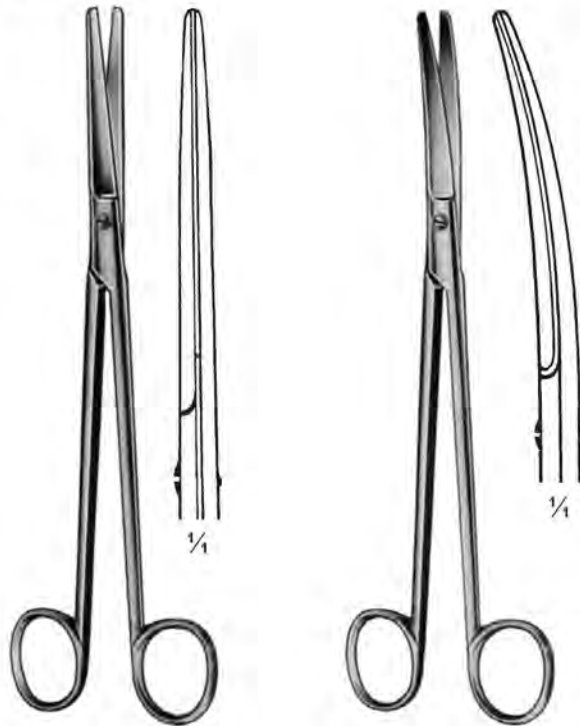

Mayo-Harrington  
62-12-20 20 cm / 8"  
62-13-23 23 cm / 9"

Mayo-Harrington  
62-14-20 20 cm / 8"  
62-15-23 23 cm / 9"

Doyen  
62-16-18  
18 cm / 7"

Doyen  
62-17-18  
18 cm / 7"

**Chirurgische Scheren  
Operating Scissors  
Ciseaux Chirurgicaux**



Wertheim  
63-01-14  
14.5 cm / 5 $\frac{3}{4}$ "

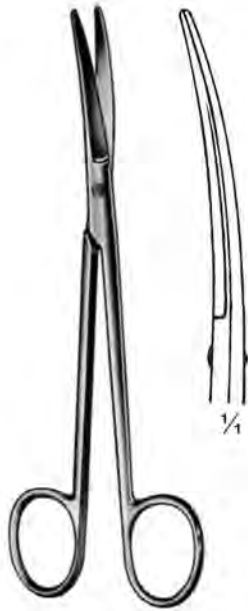

Wertheim  
63-02-14  
14.5 cm / 5 $\frac{3}{4}$ "

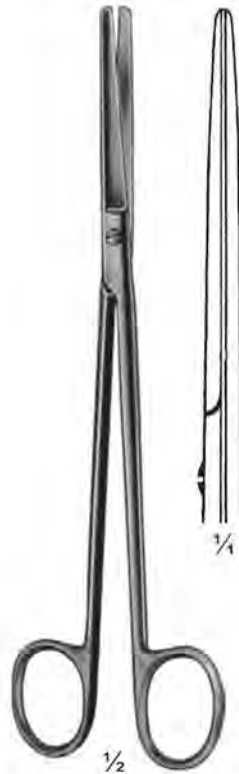

Wertheim  
63-03-20 20 cm / 8"  
63-04-23 23 cm / 9"



Wertheim  
63-05-20 20 cm / 8"  
63-06-23 23 cm / 9"



63-07-13  
13.5 cm / 5 $\frac{1}{4}$ "



63-08-16  
16 cm / 6 $\frac{1}{4}$ "



63-09-12 12.5 cm / 5"  
63-10-15 15 cm / 6"  
63-11-18 18 cm / 7"



Busch  
63-12-16  
16 cm / 6 $\frac{1}{4}$ "



Chirurgische Scheren  
Operating Scissors  
Ciseaux Chirurgicaux



Systrunk  
64-01-13  
13 cm / 5 1/8"



Systrunk  
64-02-13  
13 cm / 5 1/8"



Dublin  
64-03-12  
12 cm / 4 3/4"

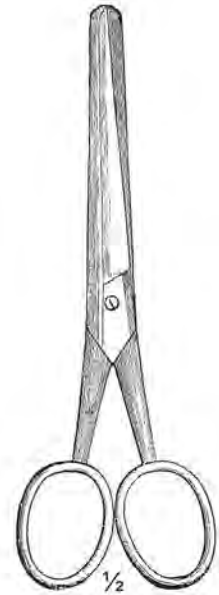

Ward  
64-04-12 12.5 cm / 5"  
64-05-15 15 cm / 6"  
64-06-18 18 cm / 7"



Mixer  
64-07-15  
15.5 cm / 6 1/8"



Mixer  
64-08-15  
15.5 cm / 6 1/8"

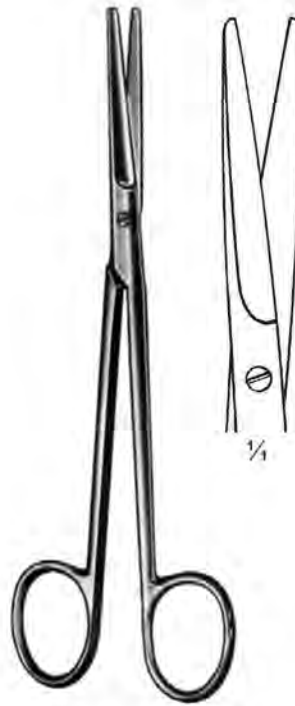

Mixer  
64-09-15  
15.5 cm / 6 1/8"



Mixer  
64-10-15  
15.5 cm / 6 1/8"

**Präparierscheren  
Dissecting Scissors  
Ciseaux à dissection**

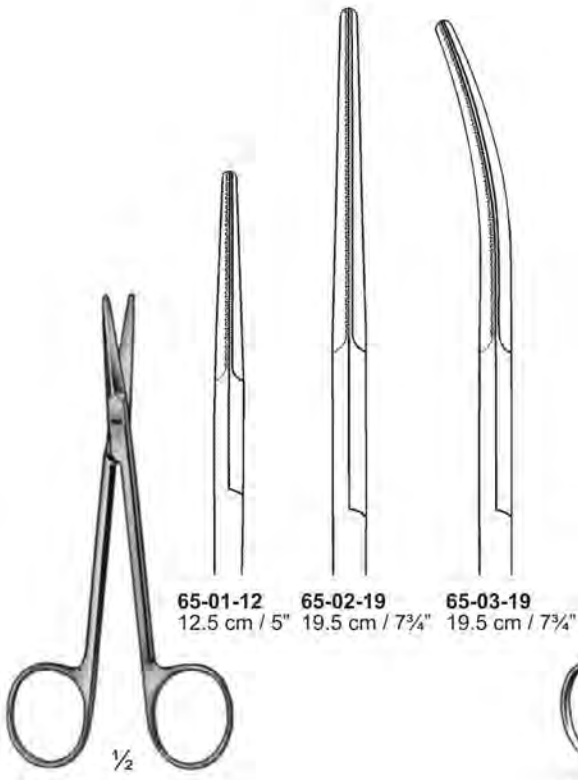

**65-01-12** 12.5 cm / 5"  
**65-02-19** 19.5 cm / 7¾"  
**65-03-19** 19.5 cm / 7¾"

Gorney  
65-01-12 To 65-03-19  
Both blades serrated

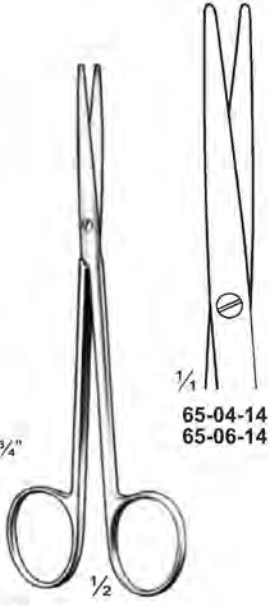

**65-04-14**  
**65-06-14**

Metzenbaum-Fino  
65-04-14 & 65-05-14  
14.5 cm / 5¾"

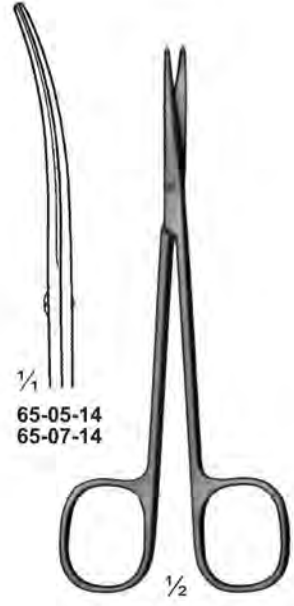

**65-05-14**  
**65-07-14**

Metzenbaum  
65-06-14 & 65-07-14  
14.5 cm / 5¾"



Metzenbaum-Fino  
65-08-14  
14.5 cm / 5¾"

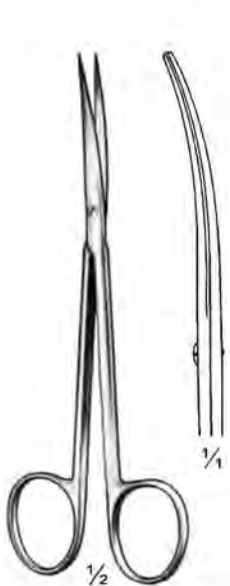

Metzenbaum-Fino  
65-09-14  
14.5 cm / 5¾"



Nerve-Preparation  
65-10-15 & 65-11-15  
15 cm / 6"

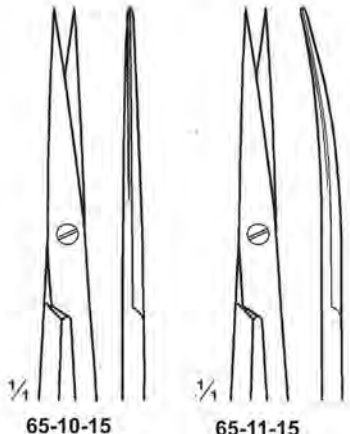

**65-10-15**

**65-11-15**



Fomon  
65-12-11 & 65-13-13

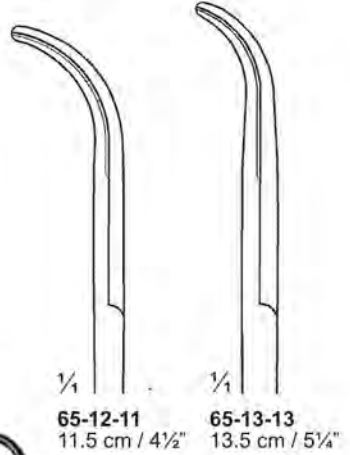

**65-12-11**  
11.5 cm / 4½"

**65-13-13**  
13.5 cm / 5¼"

**Präparierscheren  
Dissecting Scissors  
Ciseaux à dissection**

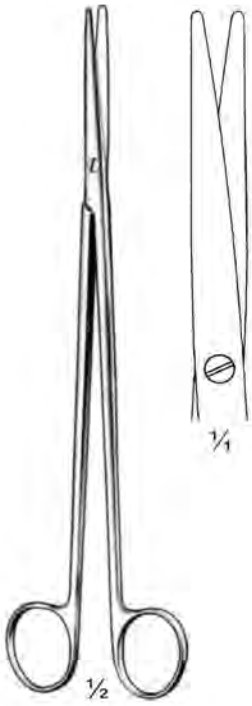

Metzenbaum-Fino  
66-01-18 18 cm / 7"  
66-02-20 20 cm / 8"  
66-03-23 23 cm / 9"

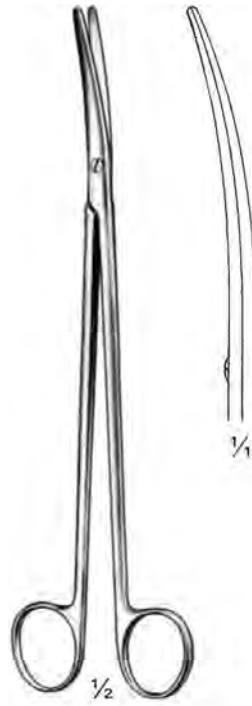

Metzenbaum-Fino  
66-04-18 18 cm / 7"  
66-05-20 20 cm / 8"  
66-06-23 23 cm / 9"

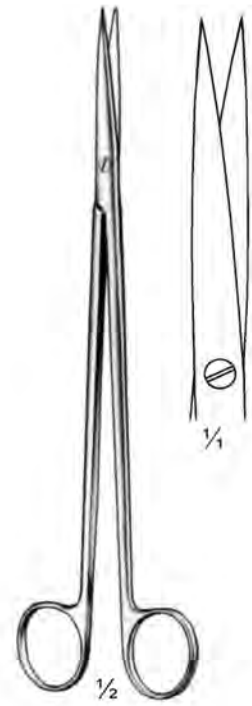

Metzenbaum-Fino  
66-07-18 18 cm / 7"  
66-08-20 20 cm / 8"  
66-09-23 23 cm / 9"

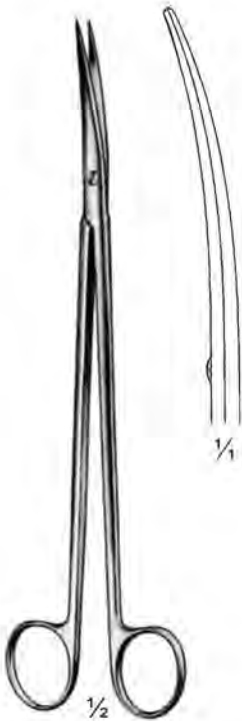

Metzenbaum-Fino  
66-10-18 18 cm / 7"  
66-11-20 20 cm / 8"  
66-12-23 23 cm / 9"

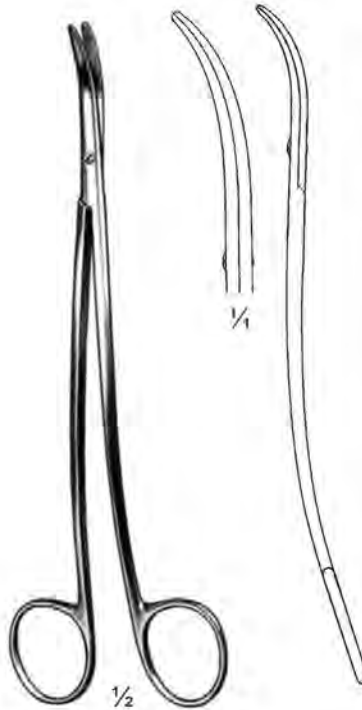

Metzenbaum-Fino  
66-13-18 18 cm / 7"  
66-14-20 20 cm / 8"  
66-15-23 23 cm / 9"



Metzenbaum-Fino  
66-16-18 18 cm / 7"  
66-17-20 20 cm / 8"  
66-18-23 23 cm / 9"

**Präparierscheren  
Dissecting Scissors  
Ciseaux à dissection**

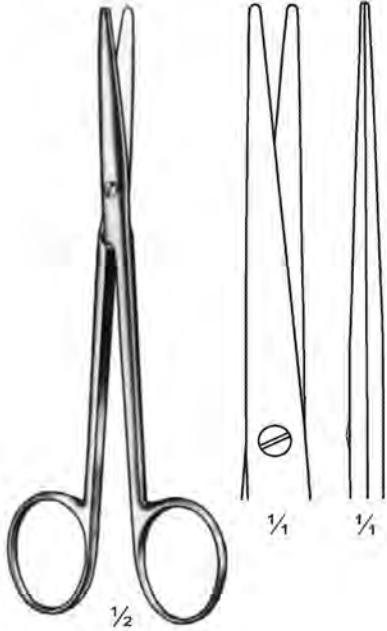

Lexer-Fino  
67-01-16 16 cm / 6 1/4"  
67-02-21 21 cm / 8 1/4"

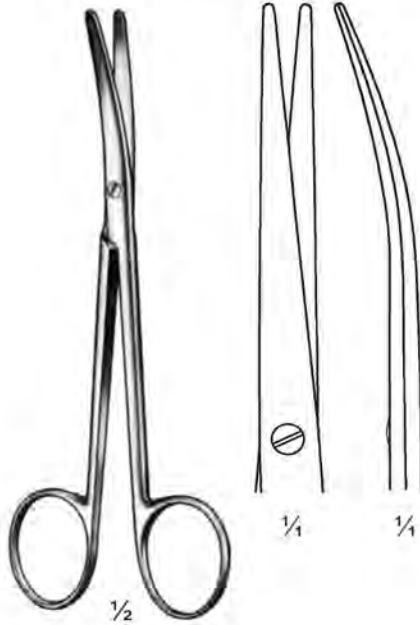

Lexer-Fino  
67-03-16 16 cm / 6 1/4"  
67-04-21 21 cm / 8 1/4"

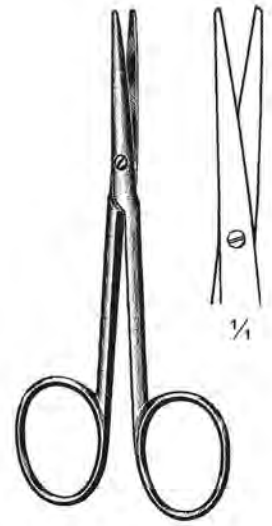

Lexer-Baby (Knapp)  
67-05-10  
10 cm / 4"

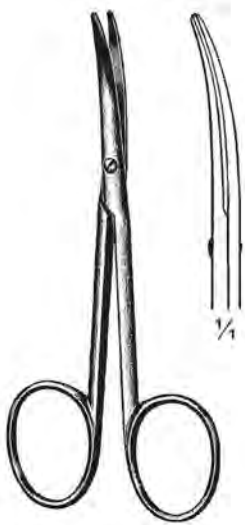

Lexer-Baby (Knapp)  
67-06-10  
10 cm / 4"

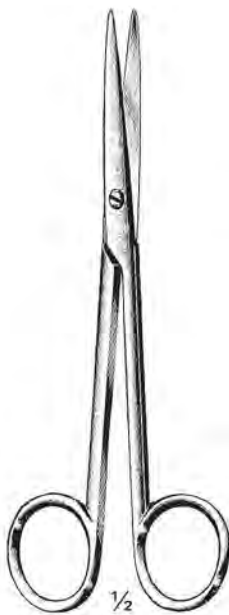

Lexer-Fino  
67-07-16 16 cm / 6 1/4"  
67-08-21 21 cm / 8 1/4"

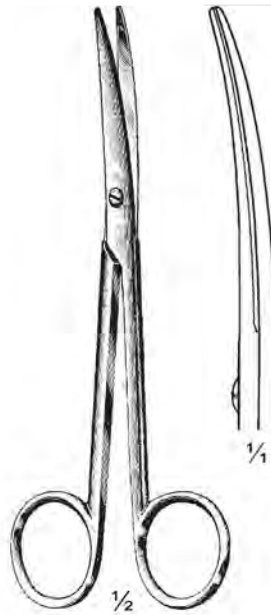

Lexer-Fino  
67-09-16 16 cm / 6 1/4"  
67-10-21 21 cm / 8 1/4"

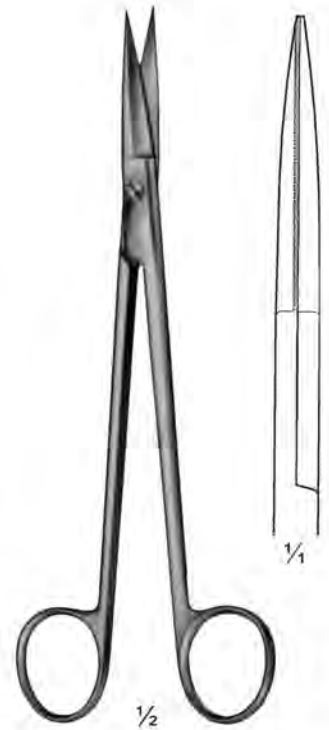

67-11-18  
18.5 cm / 7 1/4"  
Both blades  
serrated

**Präparierscheren  
Dissecting Scissors  
Ciseaux à dissection**

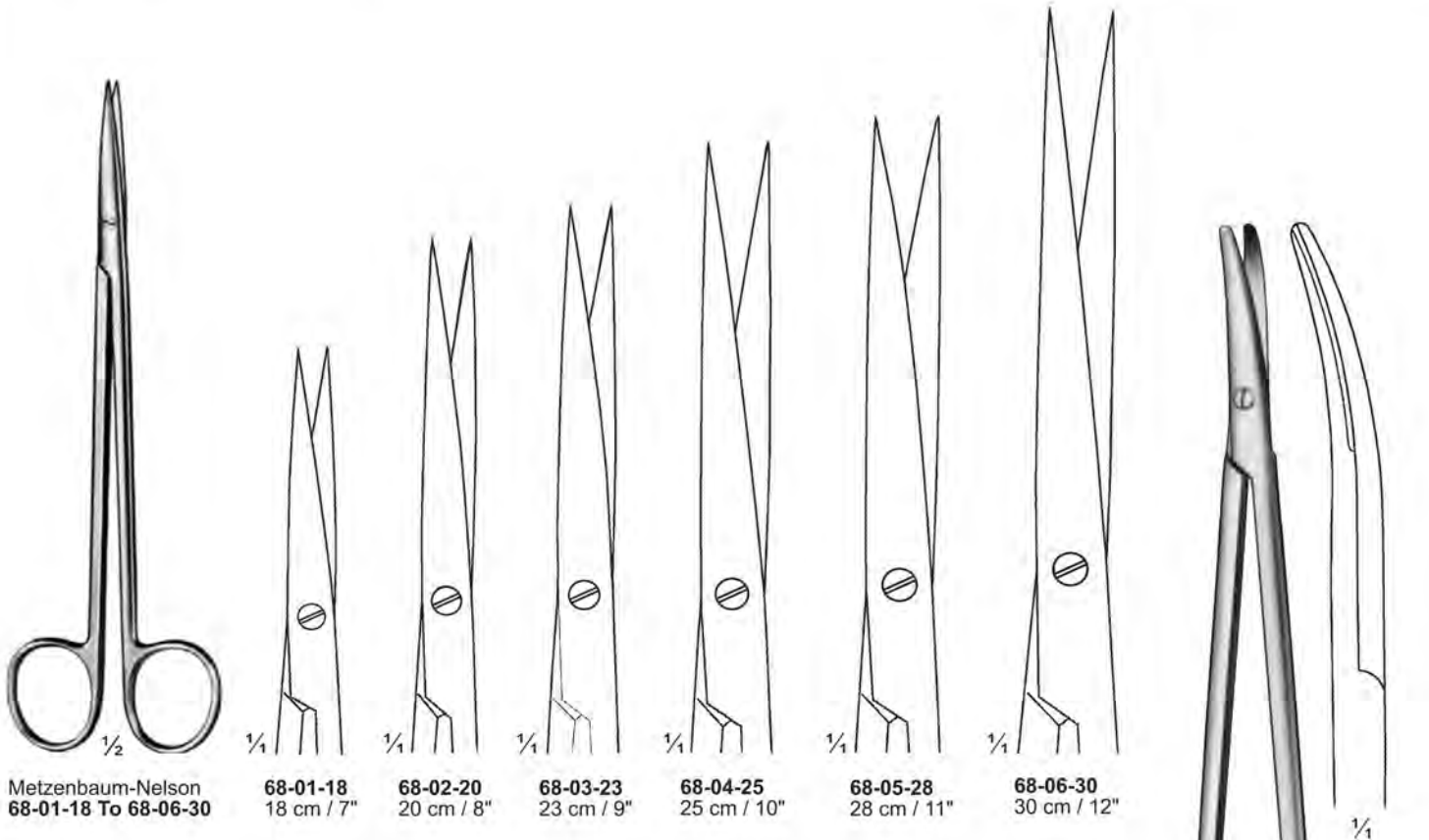

Metzenbaum-Nelson  
68-01-18 To 68-06-30

68-01-18  
18 cm / 7"

68-02-20  
20 cm / 8"

68-03-23  
23 cm / 9"

68-04-25  
25 cm / 10"

68-05-28  
28 cm / 11"

68-06-30  
30 cm / 12"

Weller  
68-13  
28 cm / 11"  
Heavy pattern

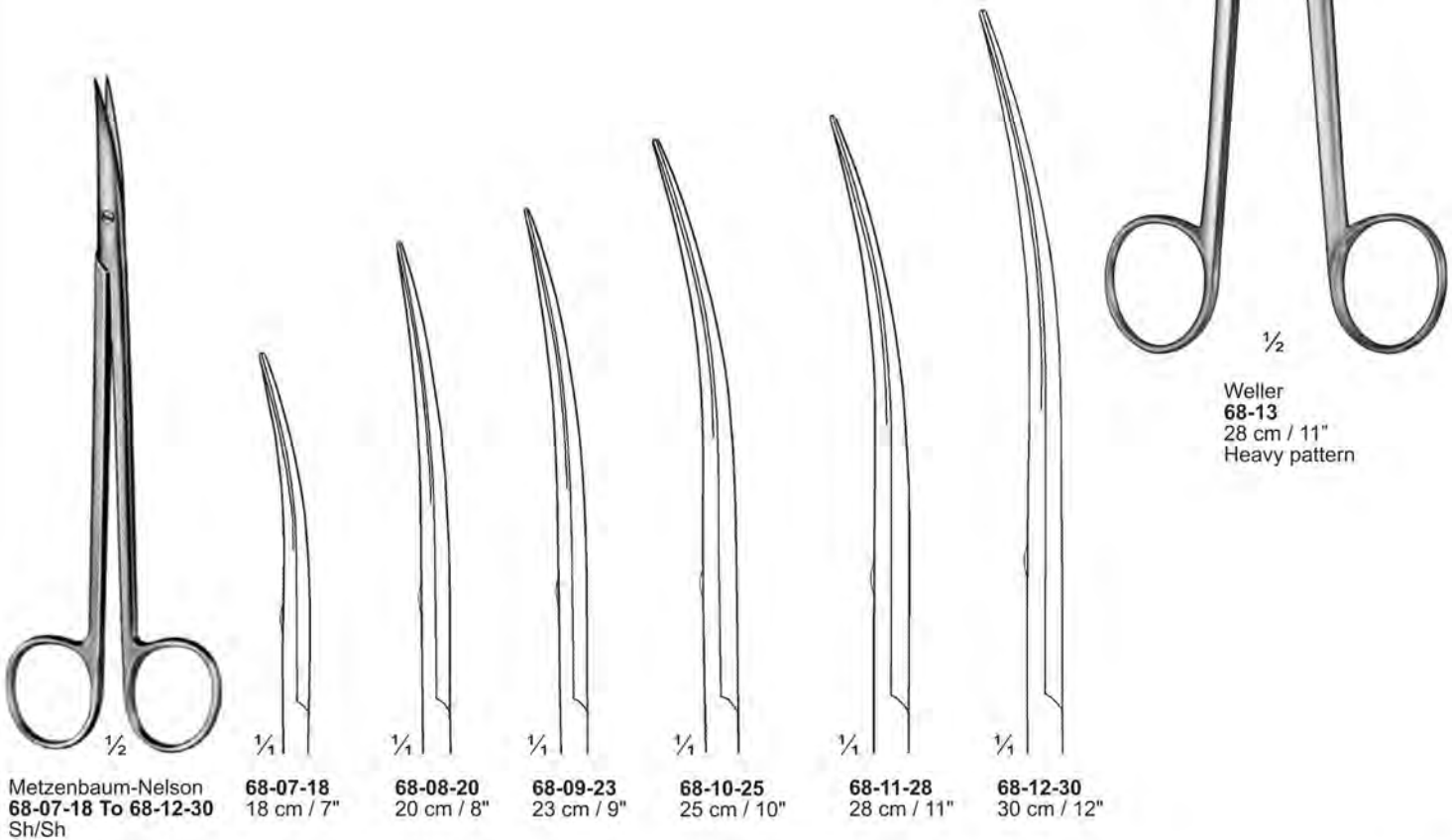

Metzenbaum-Nelson  
68-07-18 To 68-12-30  
Sh/Sh

68-07-18  
18 cm / 7"

68-08-20  
20 cm / 8"

68-09-23  
23 cm / 9"

68-10-25  
25 cm / 10"

68-11-28  
28 cm / 11"

68-12-30  
30 cm / 12"

**Präparierscheren  
Dissecting Scissors  
Ciseaux à dissection**



Metzenbaum-Nelson  
69-01-18 To 69-06-30



69-01-18  
18 cm / 7"



69-02-20  
20 cm / 8"



69-03-23  
23 cm / 9"



69-04-25  
25 cm / 10"



69-05-28  
28 cm / 11"



69-06-30  
30 cm / 12"



Metzenbaum-Nelson  
69-07-18 To 69-12-30  
Sh/Bl



69-07-18  
18 cm / 7"



69-08-20  
20 cm / 8"



69-09-23  
23 cm / 9"



69-10-25  
25 cm / 10"



69-11-28  
28 cm / 11"



69-12-30  
30 cm / 12"



Ragnell  
69-13-13  
13.5 cm / 5 1/4"



Ragnell  
69-14-13  
13.5 cm / 5 1/4"



69-15-15  
15 cm / 6"

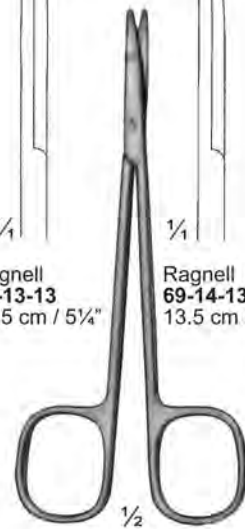

69-13-13 To 69-15-15

**Präparierscheren  
Dissecting Scissors  
Ciseaux à dissection**



Metzenbaum-Nelson  
70-01-18 To 70-06-30



70-01-18  
18 cm / 7"



70-02-20  
20 cm / 8"

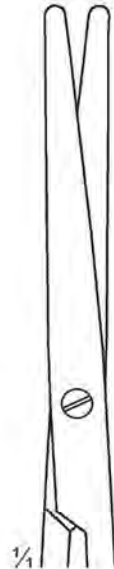

70-03-23  
23 cm / 9"



70-04-25  
25 cm / 10"

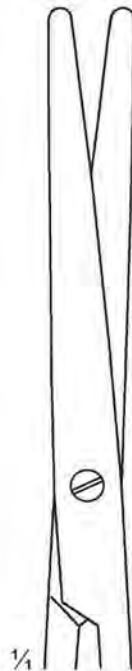

70-05-28  
28 cm / 11"



70-06-30  
30 cm / 12"



Metzenbaum-Nelson  
70-07-18 To 70-12-30  
BI/BI



70-07-18  
18 cm / 7"



70-08-20  
20 cm / 8"



70-09-23  
23 cm / 9"



70-10-25  
25 cm / 10"



70-11-28  
28 cm / 11"



70-12-30  
30 cm / 12"

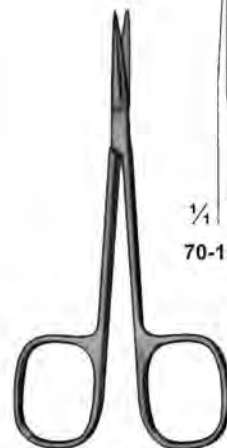

70-13-11 & 70-14-11  
11.5 cm / 4½"



70-13-11



70-14-11

**Präparierscheren ; Tijeras de disección  
Scissors ; Forbici per dissezione  
Ciseaux à dissection ; Tesouras para disseção**

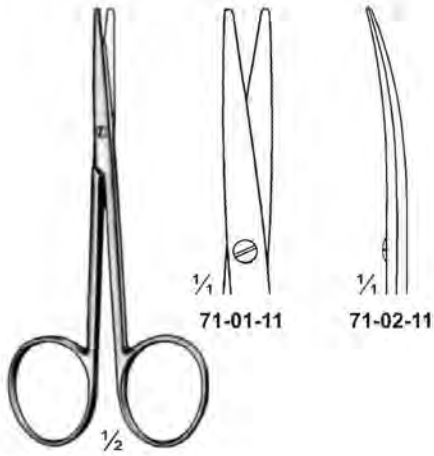

Metzenbaum  
71-01-11 & 71-02-11  
11.5 cm / 4 1/2"

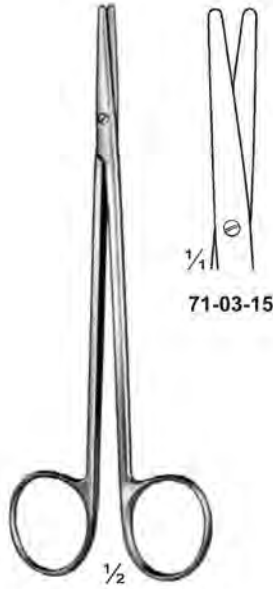

Metzenbaum  
71-03-15 & 71-04-15  
15 cm / 6"

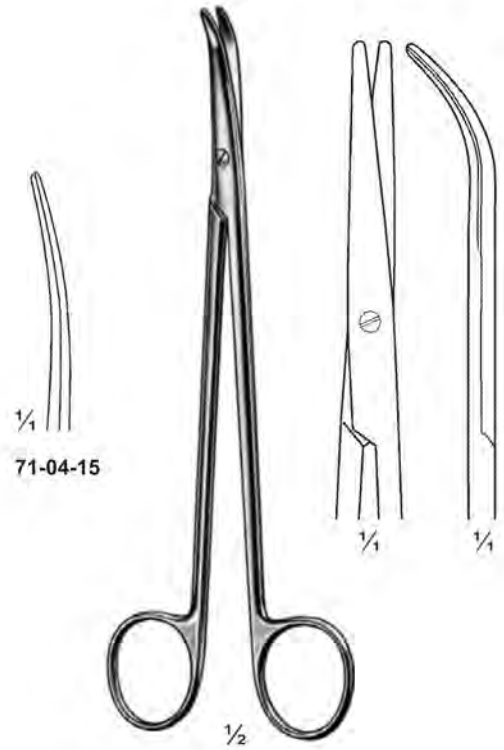

Thorek  
71-05-19  
19 cm / 7 1/2"



Metzenbaum  
71-06-14 To 71-11-14  
14.5 cm / 5 3/4"



71-06-14  
Sh/Sh



71-07-14  
Sh/Bl



71-08-14  
Bl/Bl



71-09-14  
Sh/Sh



71-10-14  
Sh/Bl

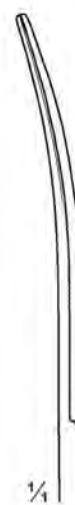

71-11-14  
Bl/Bl

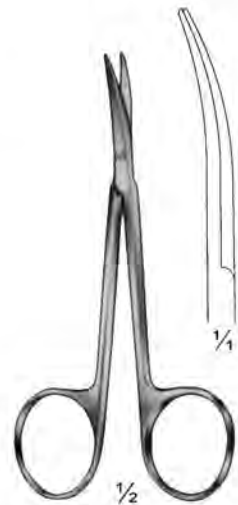

Littler  
71-12-11  
11.5 cm / 4 1/2"  
Tip with eye for suture



**Gefäßscheren ; Tijeras vasculares  
Vascular Scissors ; Forbici per chirurgia vascolare  
Ciseaux vasculaires ; Tesouras vasculares**



Potts-Smith  
72-01-60 To 72-03-25  
19 cm / 7½"

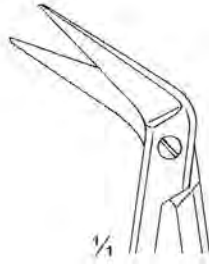

72-01-60  
60°

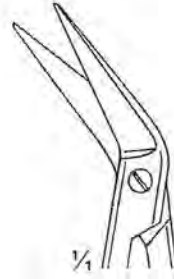

72-02-45  
45°



72-03-25  
25°



Favoloro  
72-04-15 15 cm / 6"  
72-05-17 17 cm / 6¾"

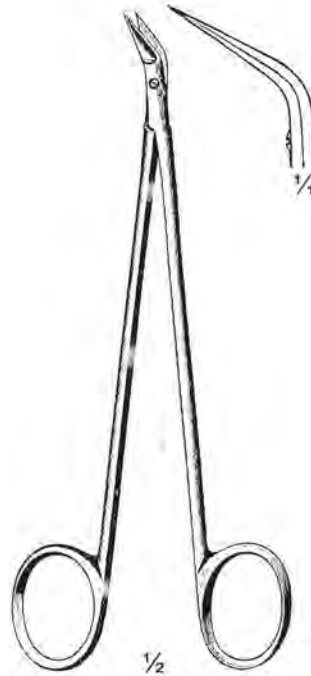

Potts-Smith  
72-06-18 18 cm / 7"

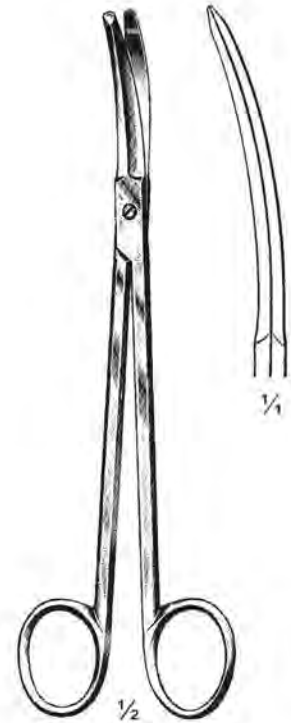

Potts-Smith  
72-08-19  
19 cm / 7½"

Gefäßscheren ; Tijeras vasculares  
 Vascular Scissors ; Forbici per chirurgia vascolare  
 Ciseaux vasculaires ; Tesouras vasculares

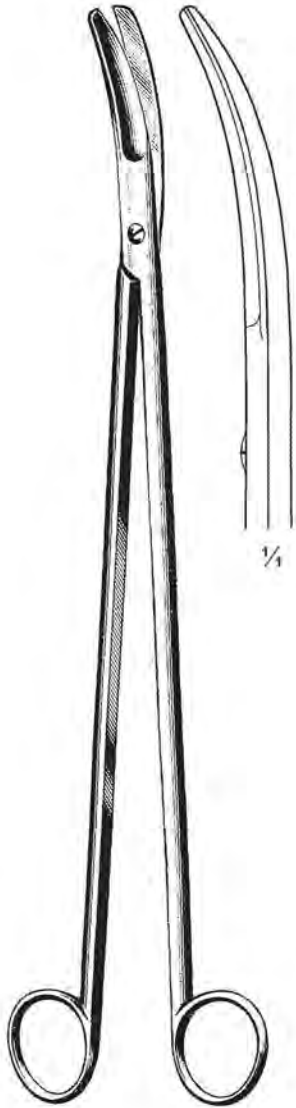

Crafoord  
 73-01-30  
 30 cm / 12"

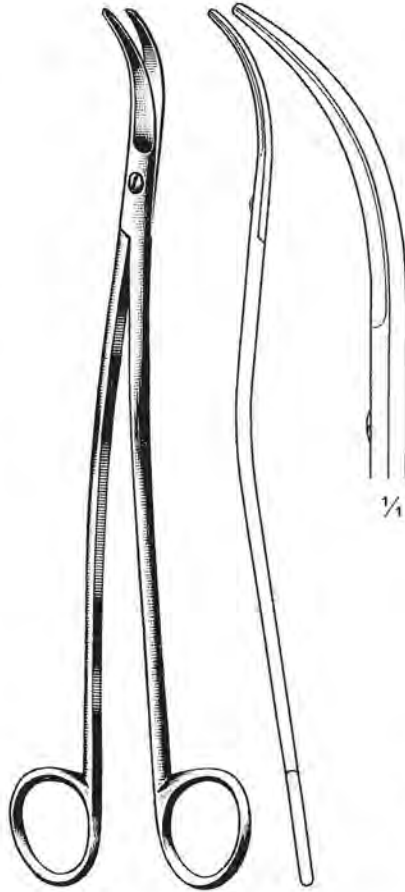

Satinsky  
 73-02-25  
 25 cm / 10"

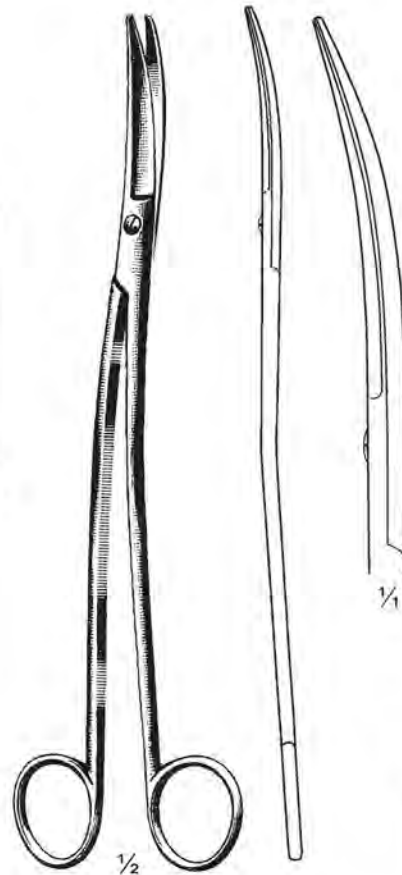

Klinkenbergh-Loth  
 73-03-23  
 23 cm / 9"

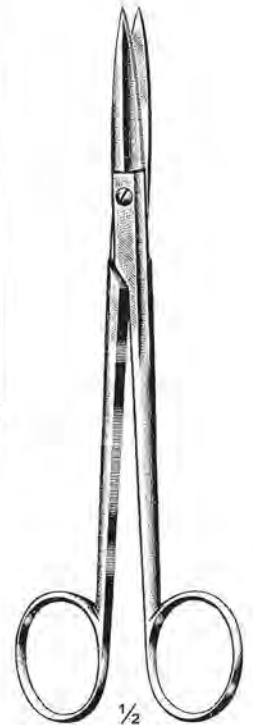

McIndoe  
 73-04-19  
 19 cm / 7 1/2"  
 One blade serrated

**Gefäßscheren ; Tijeras vasculares  
Vascular Scissors ; Forbici per chirurgia vascolare  
Ciseaux vasculaires ; Tesouras vasculares**



Dietrich  
74-01-25 To 74-05-125



74-01-25  
18 cm / 7"  
25°



74-02-45  
18 cm / 7"  
45°



74-03-60  
18 cm / 7"  
60°



74-04-90  
17 cm / 6¾"  
90°



74-05-125  
17 cm / 6¾"  
125°



Dietrich  
74-06-17  
17 cm / 6¾"

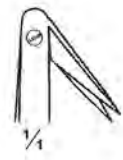

Jacobson  
74-07-18  
18.5 cm / 7¼"



¼



Yasargil  
74-08-18  
18.5 cm / 7¼"



¼  
40°



74-09-22 & 74-10-23



⅓



¼

74-09-22  
22.5 cm / 8¾"



¼

74-10-23  
23 cm / 9"



**Gefäßscheren ; Tijeras vasculares  
Vascular Scissors ; Forbici per chirurgia vascolare  
Ciseaux vasculaires ; Tesouras vasculares**

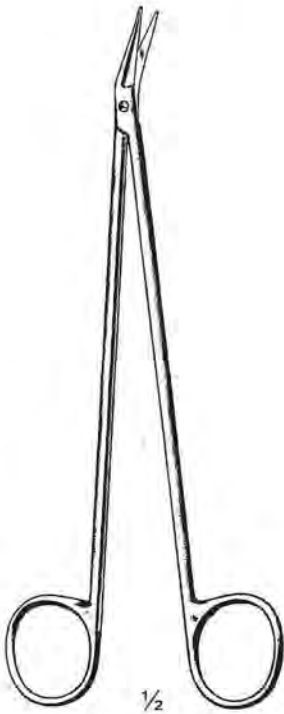

75-01-25 To 75-04-40



$\frac{1}{4}$   
Potts-De Martel  
75-01-25  
19 cm / 7½"  
25°



$\frac{1}{4}$   
Potts-De Martel  
75-02-40  
19 cm / 7½"  
40°

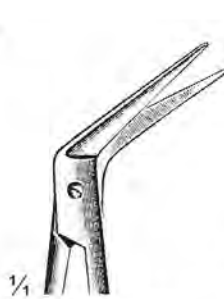

$\frac{1}{4}$   
Potts-De Martel  
75-03-60  
19 cm / 7½"  
60°



$\frac{1}{4}$   
Mills  
75-04-40  
21 cm / 8¼"  
40°  
Sh/Probe



Potts-De Martel  
75-05-21 & 75-06-24



$\frac{1}{4}$   
75-05-21  
21 cm / 8¼"

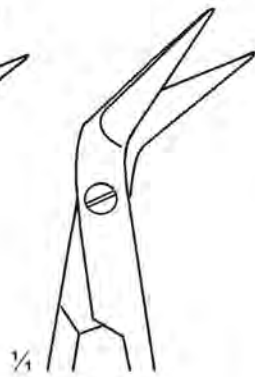

$\frac{1}{4}$   
75-06-24  
24 cm / 9½"



Strully  
75-07-22  
22 cm / 8¾"



$\frac{1}{4}$



Strully  
75-08-22  
22 cm / 8¾"

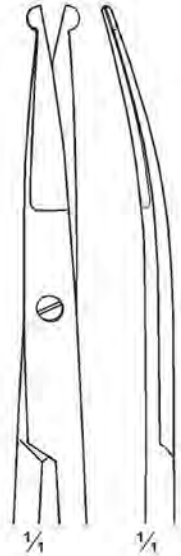

$\frac{1}{4}$

$\frac{1}{4}$

**Gefäßscheren ; Tijeras vasculares  
Vascular Scissors ; Forbici per chirurgia vascolare  
Ciseaux vasculaires ; Tesouras vasculares**



½

**Duffield**  
76-01-25 & 76-02-25  
25 cm / 10"

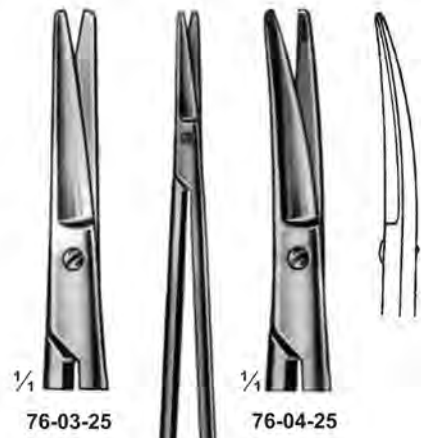

½

**Church**  
76-03-25 & 76-04-25  
25 cm / 10"

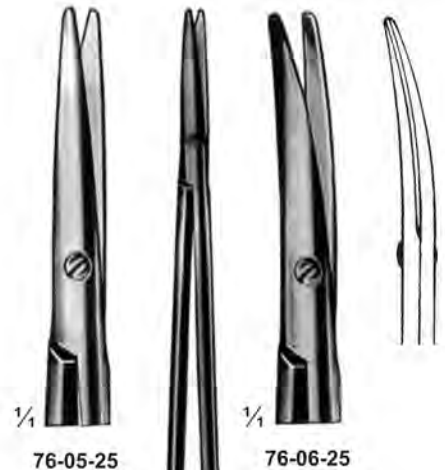

½

**Lincoln**  
76-05-25 & 76-06-25  
25 cm / 10"

**Gefäßscheren ; Tijeras vasculares  
Vascular Scissors ; Forbici per chirurgia vascolare  
Ciseaux vasculaires ; Tesouras vasculares**



**De Bakey**  
**77-01-15**  
15.5 cm / 6 1/8"

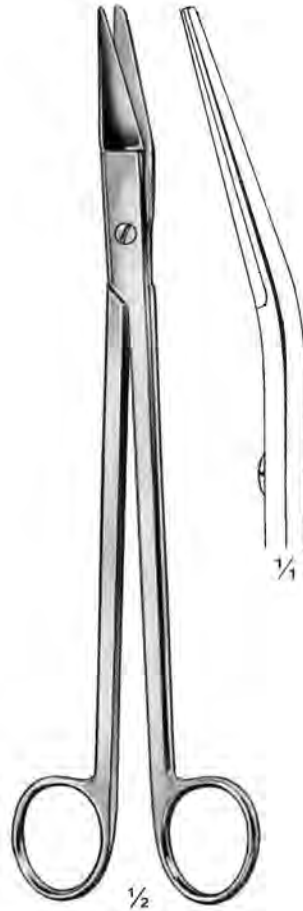

**Resano**  
**77-02-23** 23 cm / 9"  
**77-03-25** 25 cm / 10"



**Resano**  
**77-04-23** 23 cm / 9"  
**77-05-25** 25 cm / 10"

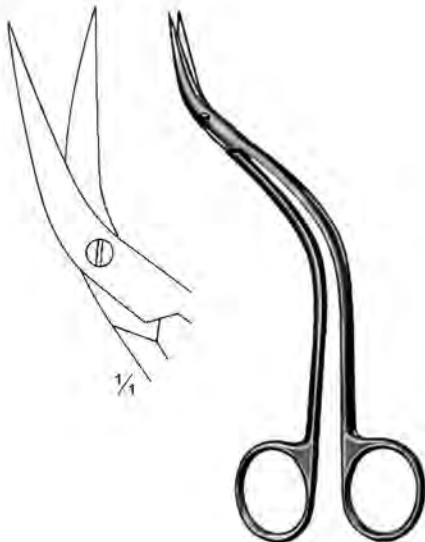

**De Bakey**  
**77-06-15**  
15.5 cm / 6 1/8"



**De Bakey**  
**77-07-25 To 77-15-60**

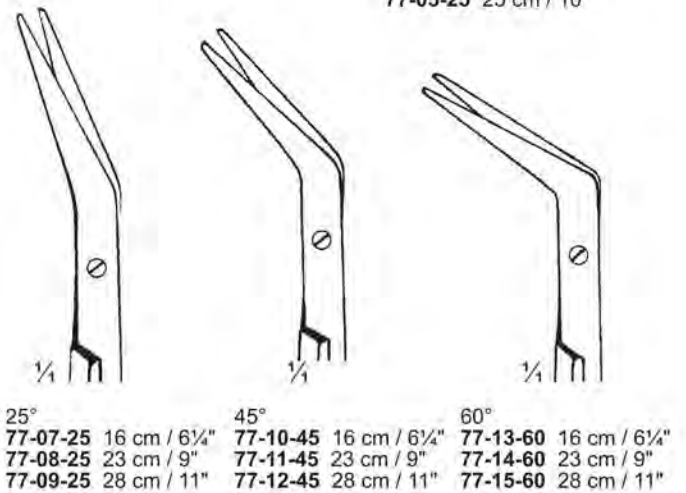

25°	45°	60°
<b>77-07-25</b> 16 cm / 6 1/4"	<b>77-10-45</b> 16 cm / 6 1/4"	<b>77-13-60</b> 16 cm / 6 1/4"
<b>77-08-25</b> 23 cm / 9"	<b>77-11-45</b> 23 cm / 9"	<b>77-14-60</b> 23 cm / 9"
<b>77-09-25</b> 28 cm / 11"	<b>77-12-45</b> 28 cm / 11"	<b>77-15-60</b> 28 cm / 11"

**Gefäßscheren ; Tijeras vasculares**  
**Vascular Scissors ; Forbici per chirurgia vascolare**  
**Ciseaux vasculaires ; Tesouras vasculares**

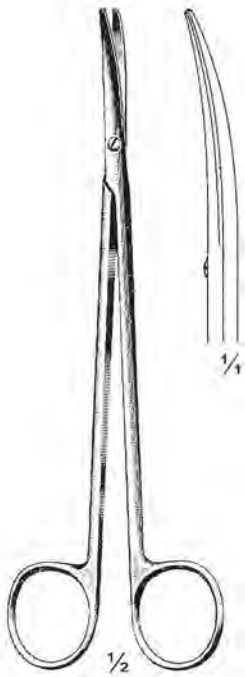

Toennis-Adson  
 78-01-18  
 18 cm / 7"

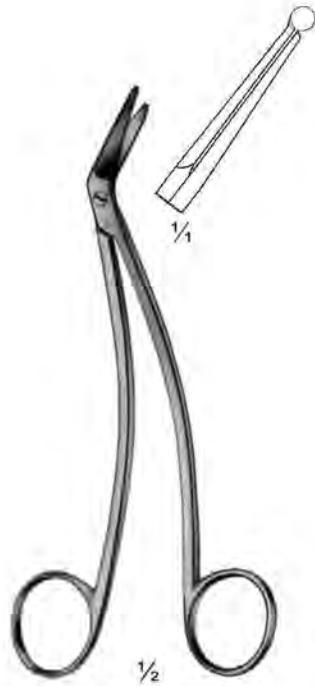

Schmieden-Taylor  
 78-02-16 16 cm / 6 1/4"  
 78-03-17 17 cm / 6 3/4"



Dandy  
 78-04-17  
 17 cm / 6 3/4"

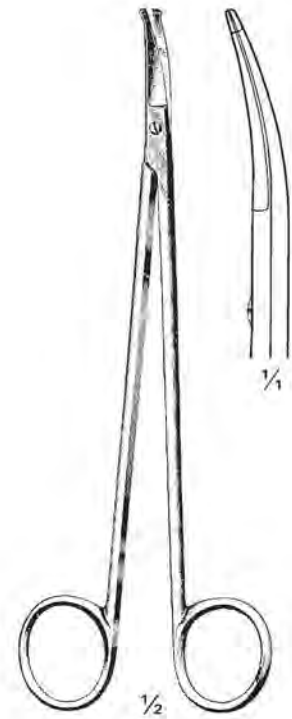

Strully  
 78-05-19 19 cm / 7 1/2"  
 78-06-22 22 cm / 8 3/4"

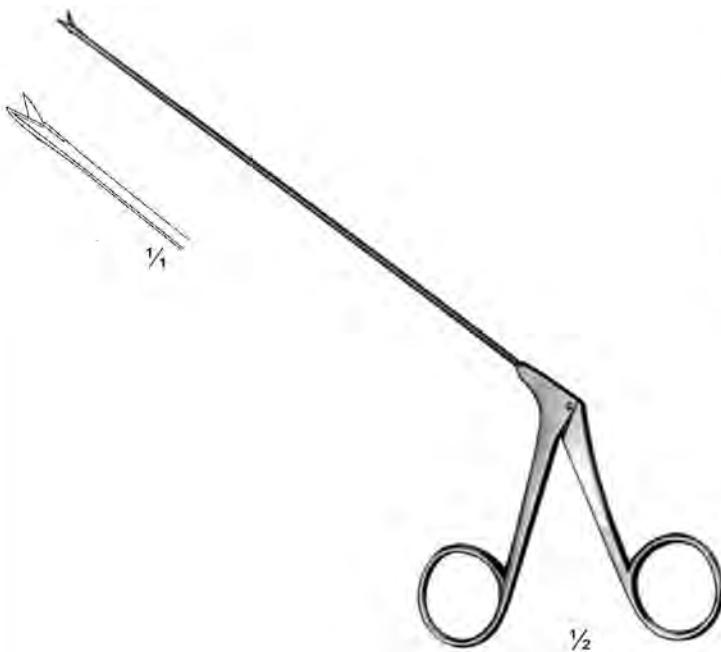

78-07-23  
 23 cm / 9"

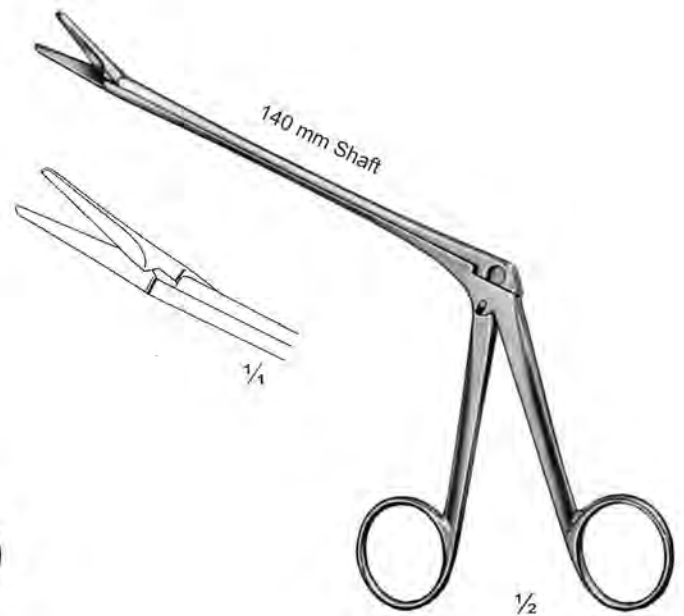

Olivecrona  
 78-08-23  
 23 cm / 9"

**Tonsillen- und Nasenschere ; Tijeras para amígdalas y nasales  
Tonsil & Nasal Scissors ; Forbici per tonsille e nasali  
Ciseaux amygdaliens et naseaux ; Tesouras nasal e amígdalas**



**Knight**  
**79-01-18**  
18 cm / 7"

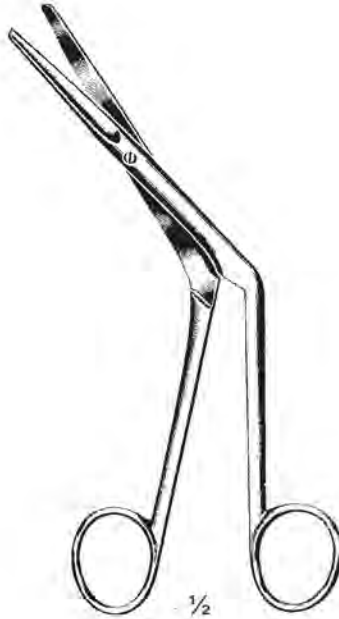

**Douglas**  
**79-02-18**  
18 cm / 7"

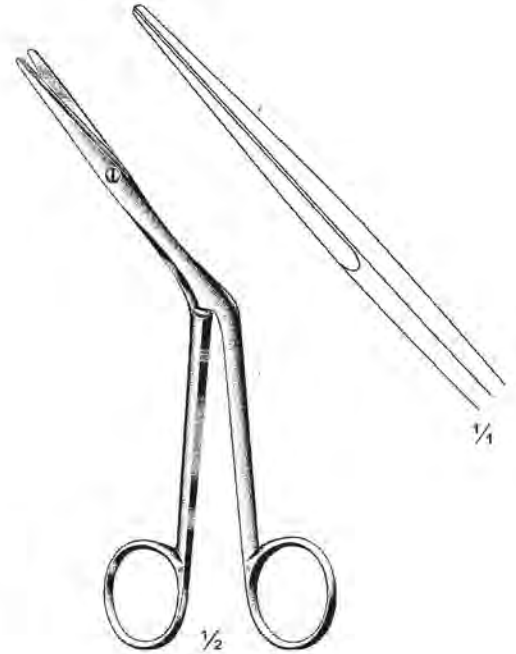

**Heymann**  
**79-03-18**  
18 cm / 7"



**Fomon**  
**79-04-15**  
15 cm / 6"



**Cottle**  
**79-05-16**  
16 cm / 6¼"



Tonsillen- und Nasenschere ; Tijeras para amígdalas y nasales  
 Tonsil & Nasal Scissors ; Forbici per tonsille e nasali  
 Ciseaux amygdaliens et naseaux ; Tesouras nasal e amígdalas



80-01-17

80-02-17  
One blade  
serrated

Dean  
80-01-17 & 80-02-17  
17 cm / 6 3/4"

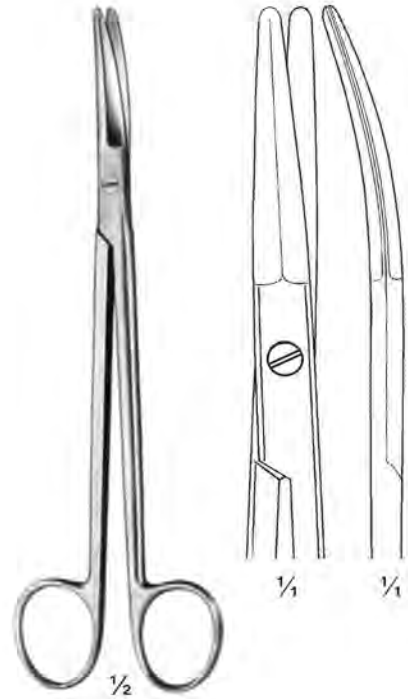

Boettcher  
80-03-18  
18 cm / 7"

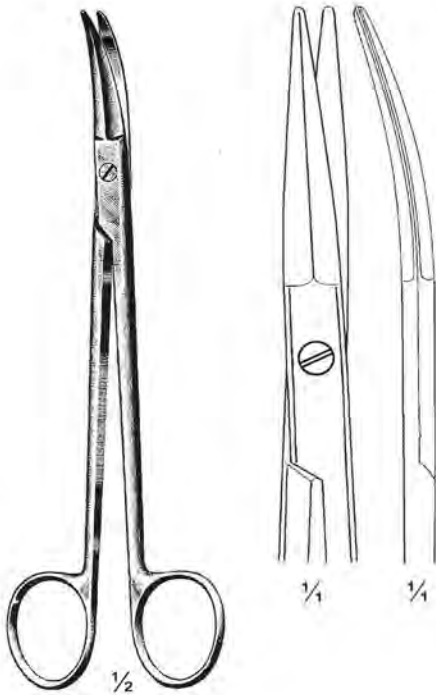

Prince  
80-04-18  
18 cm / 7"

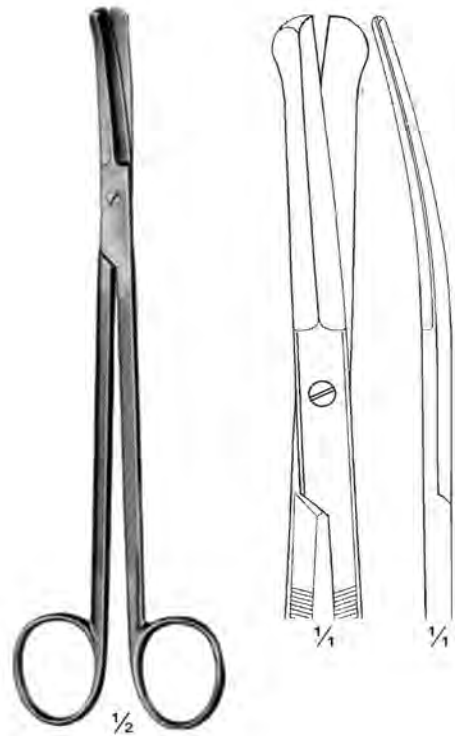

Good  
80-05-19  
19 cm / 7 1/2"

Gynäkologische Scheren ; Tijeras para ginecología  
 Gynecological Scissors ; Forbici per ginecologica  
 Ciseaux à gynécologie ; Tesouras para ginecologia



Werthiem  
 81-01-14 To 81-03-23

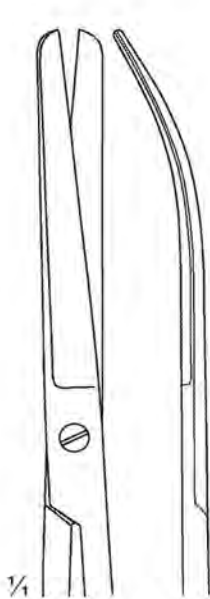

81-01-14  
 14.5 cm / 5 3/4"

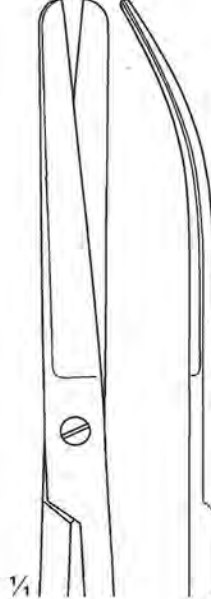

81-02-19  
 19.5 cm / 7 3/4"

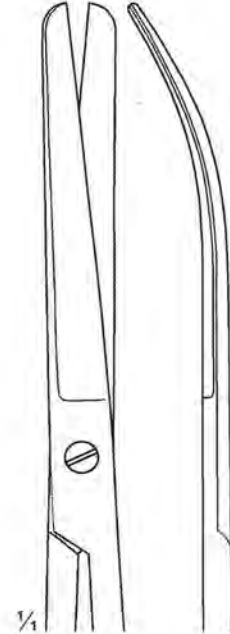

81-03-23  
 23 cm / 9"

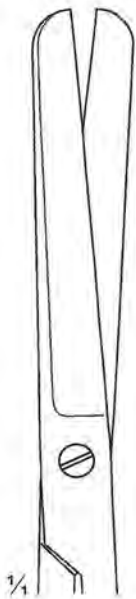

81-04-20  
 20 cm / 8"

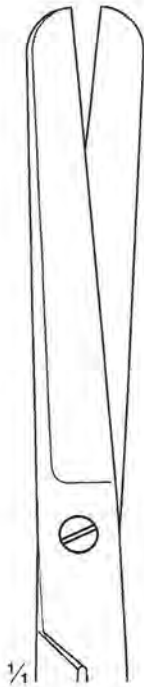

81-05-23  
 23 cm / 9"



81-06-20  
 20 cm / 8"



81-07-23  
 23 cm / 9"



Sims  
 81-04-20 To 81-07-23

Gynäkologische Scheren ; Tijeras para ginecología  
 Gynecological Scissors ; Forbici per ginecologica  
 Ciseaux à gynécologie ; Tesouras para ginecologia



Doyen  
 82-01-18 To 82-02-18  
 18 cm / 7"

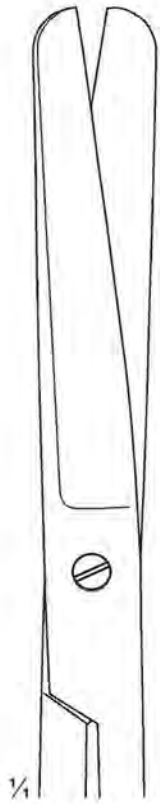

82-01-18



82-02-18



Sims  
 82-03-20 To 82-10-23



82-03-20  
 20 cm / 8"  
 82-04-23  
 23 cm / 9"



82-05-20  
 20 cm / 8"  
 82-06-23  
 23 cm / 9"



82-07-20  
 20 cm / 8"  
 82-08-23  
 23 cm / 9"



82-09-20  
 20 cm / 8"  
 82-10-23  
 23 cm / 9"

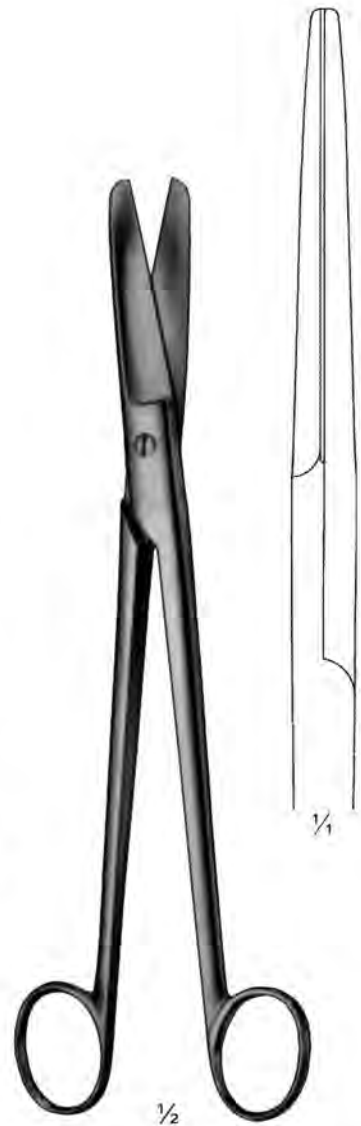

Sims-Siebold  
 82-11-25  
 25 cm / 10"

Gynäkologische Scheren ; Tijeras para ginecología  
 Gynecological Scissors ; Forbici per ginecologica  
 Ciseaux à gynécologie ; Tesouras para ginecologia

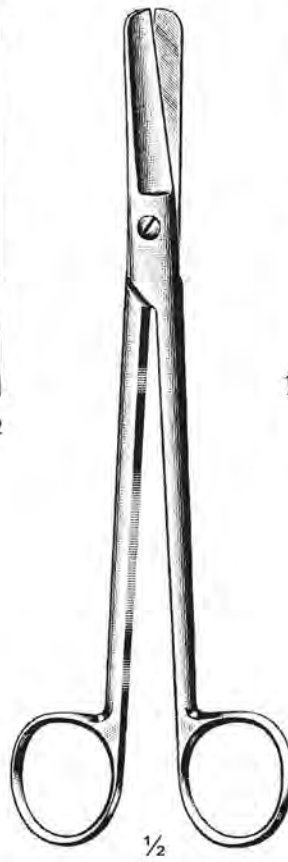
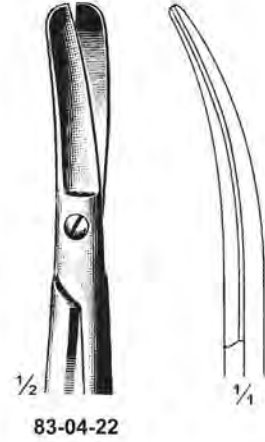

Sims  
 83-03-22 To 83-04-22  
 22 cm / 8 3/4"

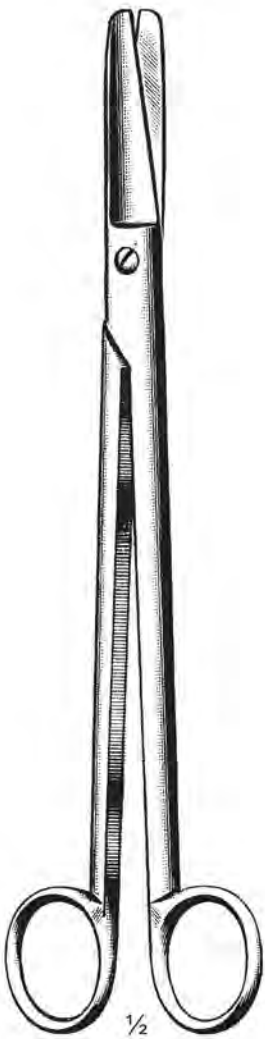

Dubois  
 83-01-27  
 27 cm / 10 1/2"

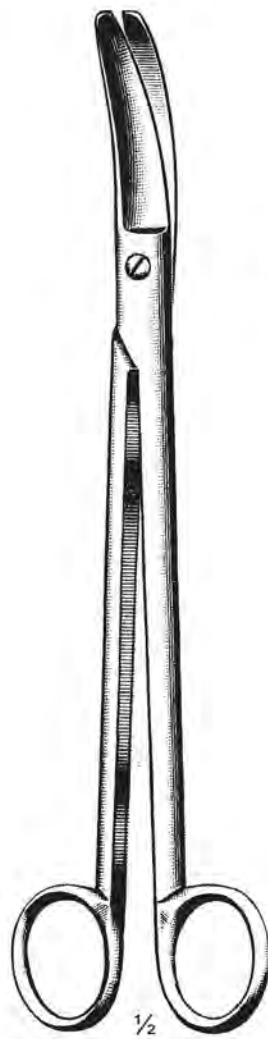

Dubois  
 83-02-27  
 27 cm / 10 1/2"

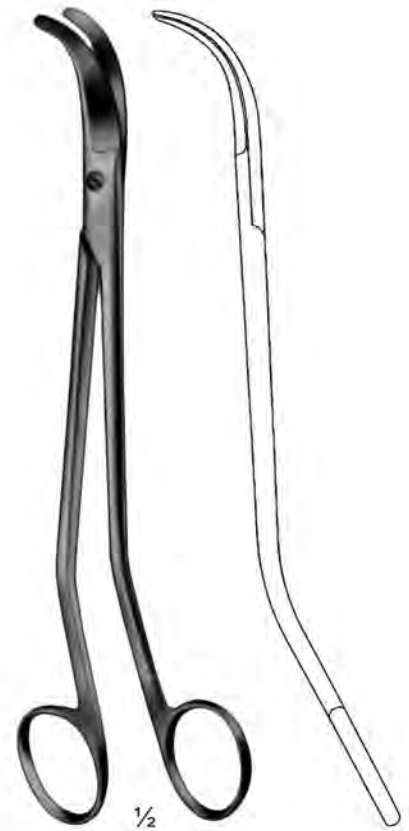

Bozemann  
 83-05  
 22 cm / 8 3/4"

**Gynäkologische Scheren ; Tijeras para ginecología  
Gynecological Scissors ; Forbici per ginecologica  
Ciseaux à gynécologie ; Tesouras para ginecologia**



Mayo-Noble  
84-01-14 To 84-04-17

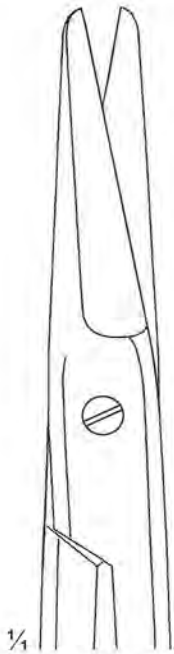

84-01-14 14 cm / 5½"  
84-02-17 17 cm / 6¾"



84-03-14 14 cm / 5½"  
84-04-17 17 cm / 6¾"

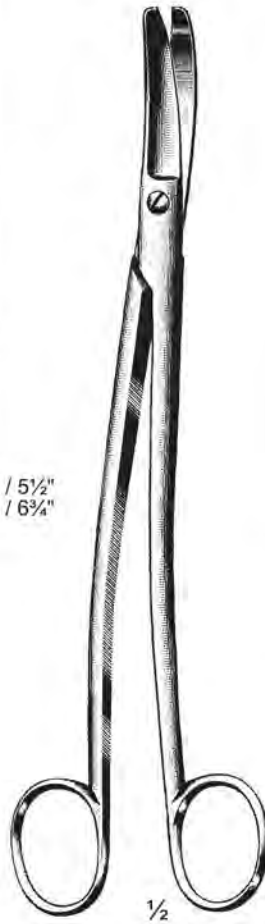

Siebold  
84-09-24  
24 cm / 9½"

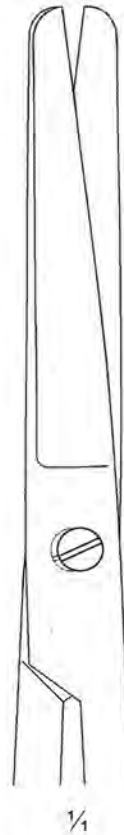

Mayo-Noble  
84-05-14 14 cm / 5½"  
84-06-17 17 cm / 6¾"

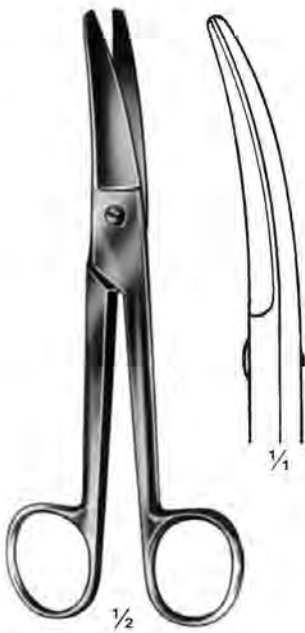

Mayo-Noble  
84-07-14 14 cm / 5½"  
84-08-17 17 cm / 6¾"

Gynäkologische Scheren ; Tijeras para ginecología  
 Gynecological Scissors ; Forbici per ginecologica  
 Ciseaux à gynécologie ; Tesouras para ginecologia

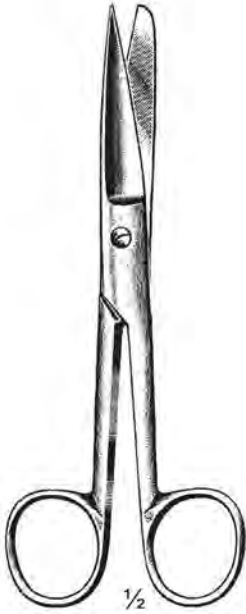

85-01-16  
16 cm / 6¼"



85-02-16 16 cm / 6¼"  
85-03-18 18 cm / 7"

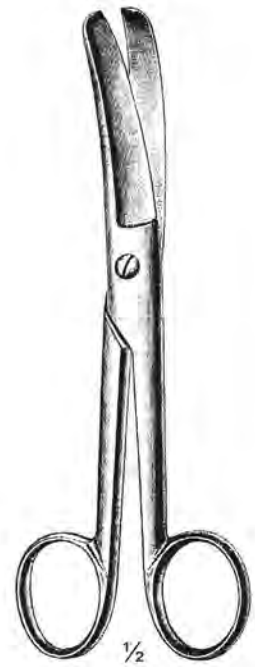

85-04-16 16 cm / 6¼"  
85-05-18 18 cm / 7"

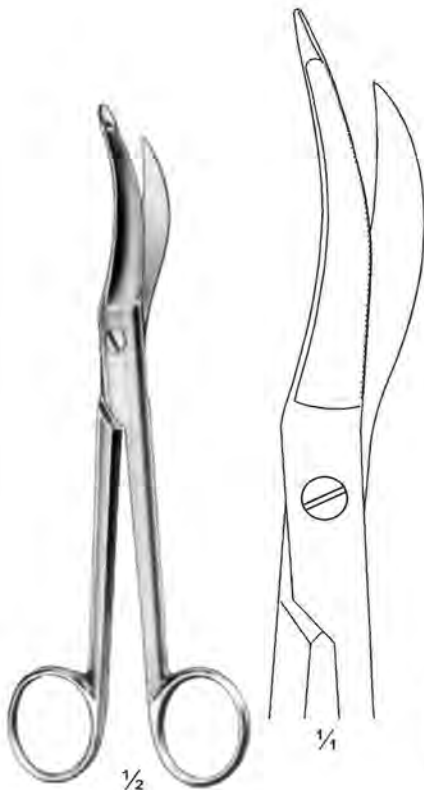

Waldmann  
85-06-18  
18 cm / 7"

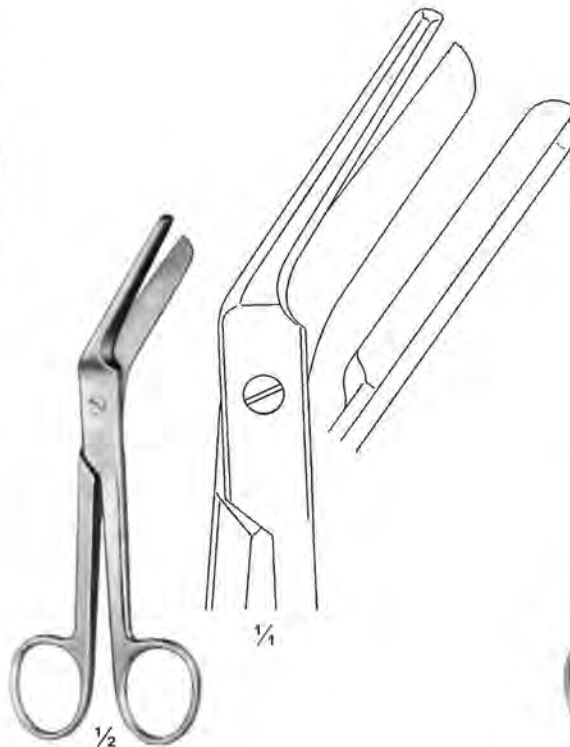

Braun-Stadler  
85-07-14 14.5 cm / 5¾"  
85-08-16 16 cm / 6¼"

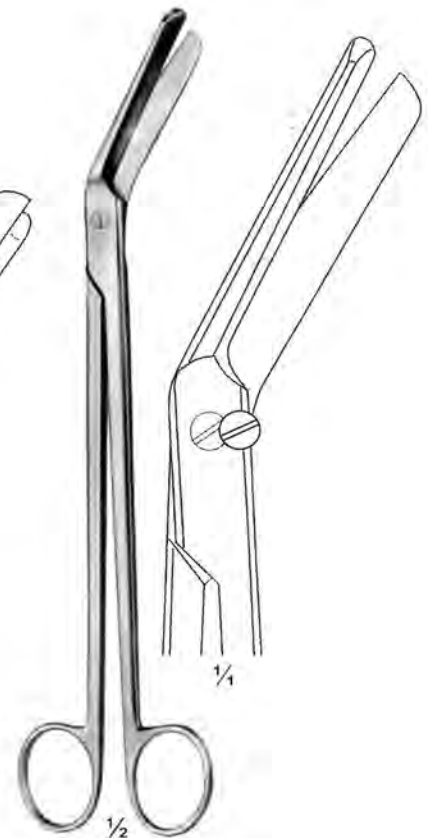

Braun-Stadler  
85-09-22  
22 cm / 8¾"

Scheren für Geburtshilfe ; Tijeras para obstetricia  
 Scissors for Obstetrics ; Forbici per obstetricia  
 Ciseaux à obstétrique ; Tesouras para obstétrica



Mod. USA  
 86-01-10  
 10.5 cm / 4 1/8"



Schumacher  
 86-02-15  
 15.5 cm / 6 1/8"



86-03-13 To  
 86-04-16

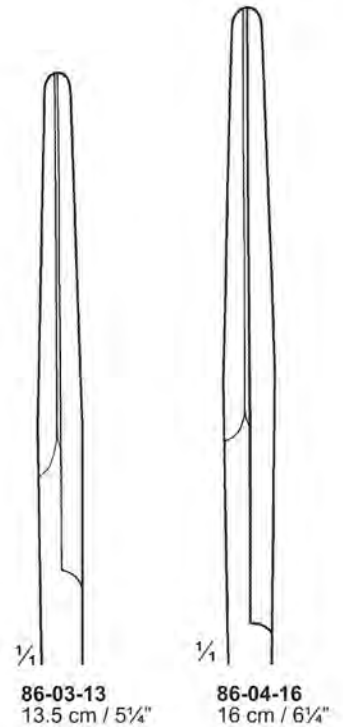

86-03-13  
 13.5 cm / 5 1/4"

86-04-16  
 16 cm / 6 1/4"

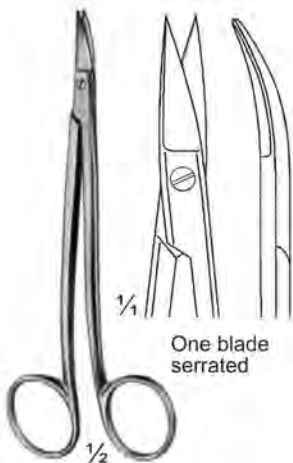

Nuemann  
 86-05  
 12 cm / 4 3/4"

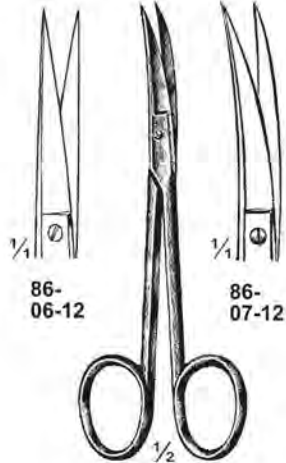

Wagner  
 86-06-12 To  
 86-07-12  
 12 cm / 4 3/4"

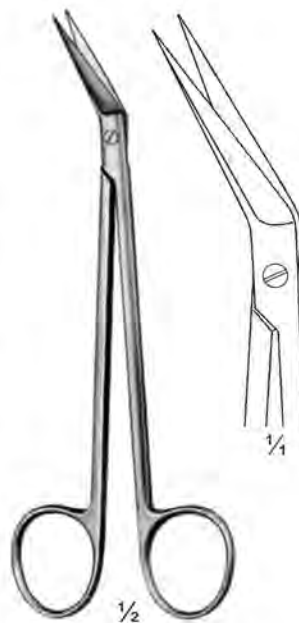

Locklin  
 86-08-16  
 16 cm / 6 1/4"

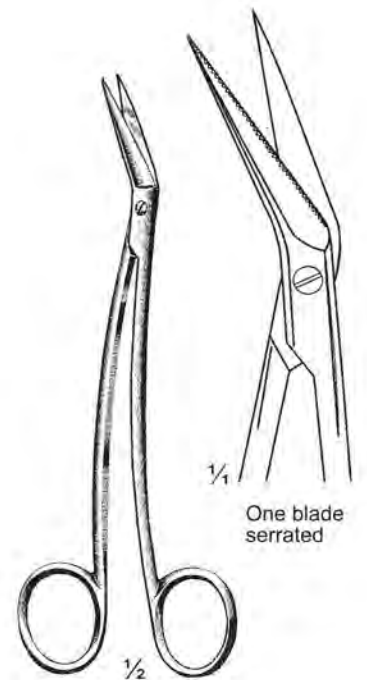

Locklin  
 86-09-19  
 16 cm / 6 1/4"

Tungsten Carbide Scheren ; Tijeras de carburo de tungsteno  
 Tungsten Carbide Scissors ; Forbici di carburo di tungsteno  
 Ciseaux en carbure de tungstène ; Tesoura de carboneto de tungstênio



Iris  
**87-01-11**  
 11.5 cm / 4½"

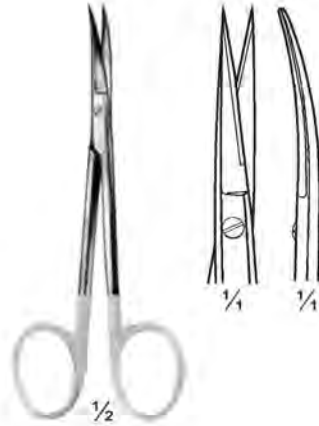

Iris  
**87-02-11**  
 11.5 cm / 4½"

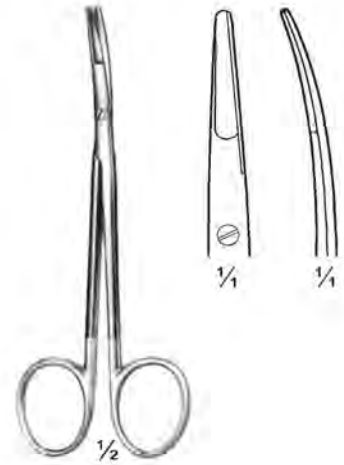

Ragnell (Kilner)  
**87-03-12**  
 12 cm / 4¾"

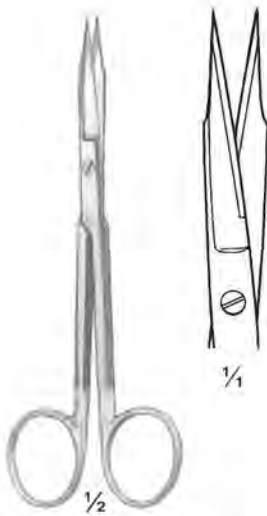

Goldman-Fox  
**87-04-13**  
 13 cm / 5¼"

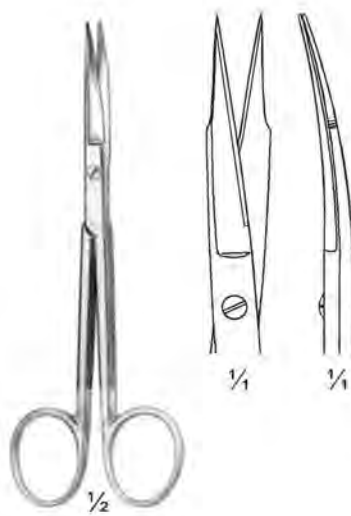

Goldman-Fox  
**87-05-13**  
 13 cm / 5¼"

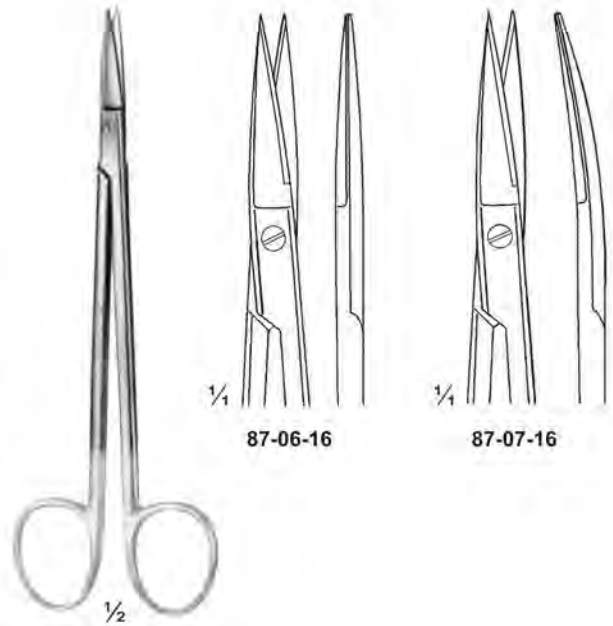

Kelly  
**87-06-16 To 87-07-16**  
 16 cm / 6¼"



**Tungsten Carbide Scheren ; Tijeras de carburo de tungsteno  
Tungsten Carbide Scissors ; Forbici di carburo di tungsteno  
Ciseaux en carbure de tungstène ; Tesoura de carboneto de tungstênio**



Potts-Smith  
88-01-25 To 88-06-60



88-01-25  
19 cm / 7 1/2"  
25°

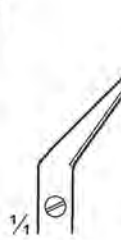

88-02-45  
19 cm / 7 1/2"  
45°



88-03-60  
19 cm / 7 1/2"  
60°



88-04-25  
23 cm / 9"  
25°

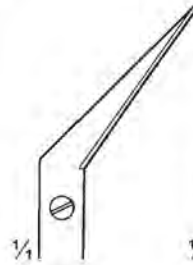

88-05-45  
23 cm / 9"  
45°

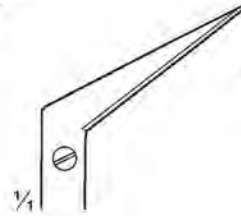

88-06-60  
23 cm / 9"  
60°



88-07-25  
19 cm / 7 1/2"  
25°

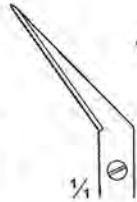

88-08-45  
19 cm / 7 1/2"  
45°

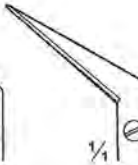

88-09-60  
19 cm / 7 1/2"  
60°



88-10-25  
23 cm / 9"  
25°

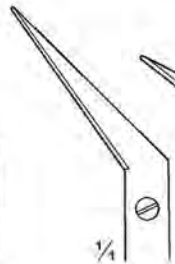

88-11-45  
23 cm / 9"  
45°

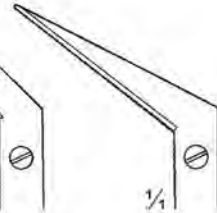

88-12-60  
23 cm / 9"  
60°



Potts-Smith  
88-07-25 To 88-12-60

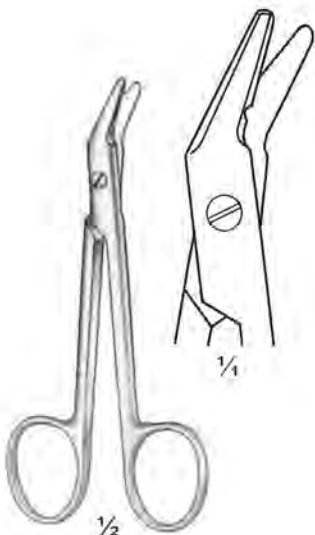

Universal  
88-13-12  
12 cm / 4 3/4"



Locklin  
88-14-16  
16 cm / 6 1/4"

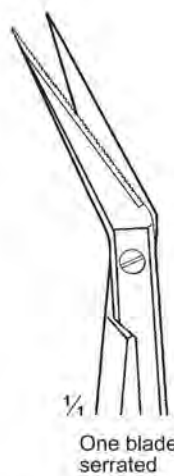

1/4  
One blade serrated



Locklin  
88-15-16  
16 cm / 6 1/4"

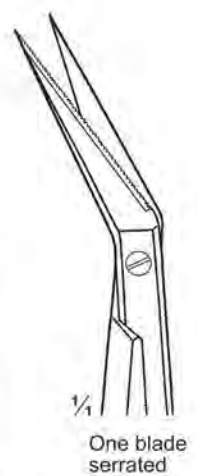

1/4  
One blade serrated

**Tungsten Carbide Scheren ; Tijeras de carburo de tungsteno  
Tungsten Carbide Scissors ; Forbici di carburo di tungsteno  
Ciseaux en carbure de tungstène ; Tesoura de carboneto de tungstênio**



De Bakey  
89-01-25 To 89-12-60

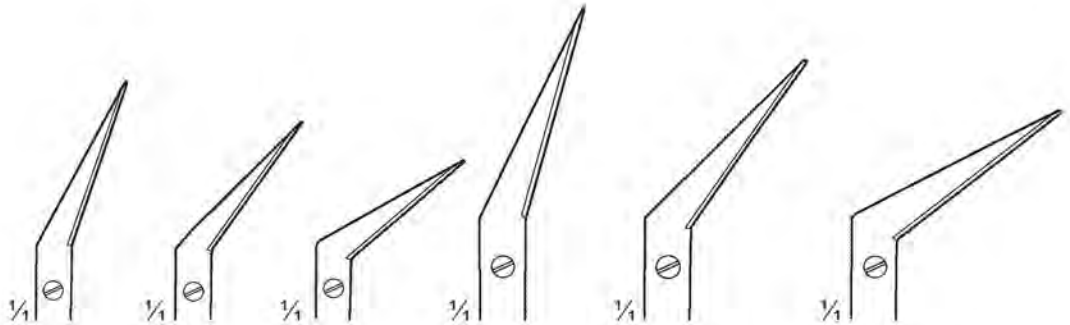

**89-01-25**  
19 cm / 7½"  
25°

**89-02-45**  
19 cm / 7½"  
45°

**89-03-60**  
19 cm / 7½"  
60°

**89-04-25**  
23 cm / 9"  
25°

**89-05-45**  
23 cm / 9"  
45°

**89-06-60**  
23 cm / 9"  
60°

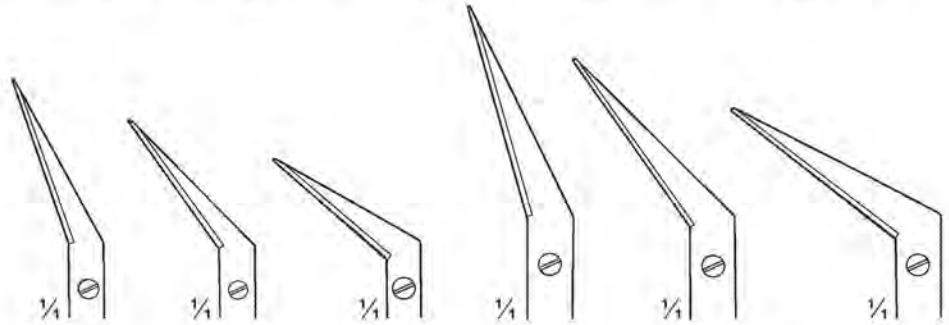

**89-07-25**  
19 cm / 7½"  
25°

**89-08-45**  
19 cm / 7½"  
45°

**89-09-60**  
19 cm / 7½"  
60°

**89-10-25**  
23 cm / 9"  
25°

**89-11-45**  
23 cm / 9"  
45°

**89-12-60**  
23 cm / 9"  
60°

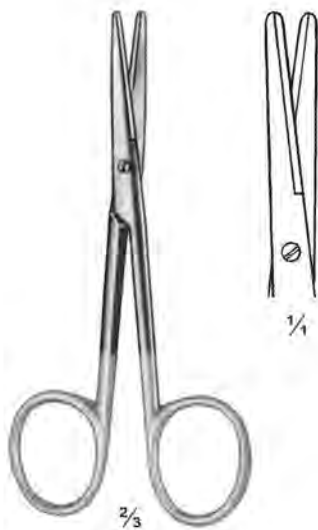

Lexer-Baby (Knapp)  
**89-13-10** 10 cm / 4"  
**89-14-12** 12 cm / 4¾"



Lexer-Baby (Knapp)  
**89-15-10** 10 cm / 4"  
**89-16-12** 12 cm / 4¾"

**Tungsten Carbide Scheren ; Tijeras de carburo de tungsteno  
Tungsten Carbide Scissors ; Forbici di carburo di tungsteno  
Ciseaux en carbure de tungstène ; Tesoura de carboneto de tungstênio**



Lexer  
90-01-16 & 90-02-21

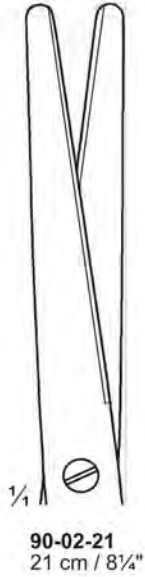
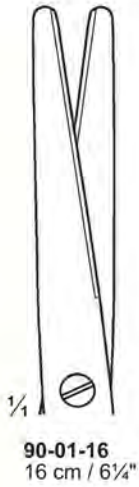

Lexer  
90-03-16 & 90-04-21

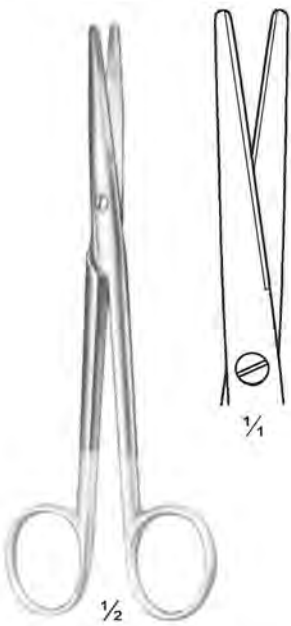
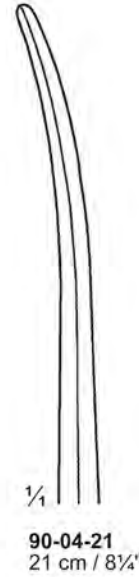
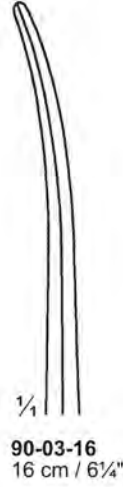

Mayo-Lexer  
90-05-16  
16 cm / 6 1/4"

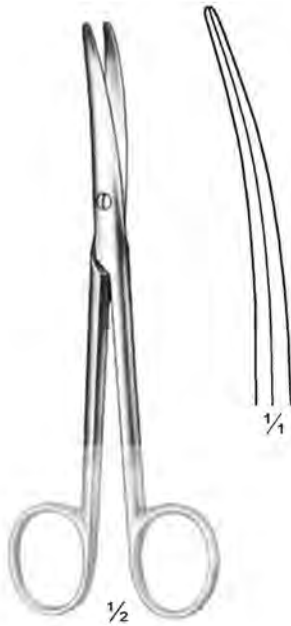
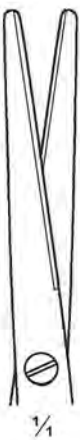

Mayo-Lexer  
90-06-16  
16 cm / 6 1/4"



90-07-23  
23 cm / 9"



90-08-25  
25 cm / 10"

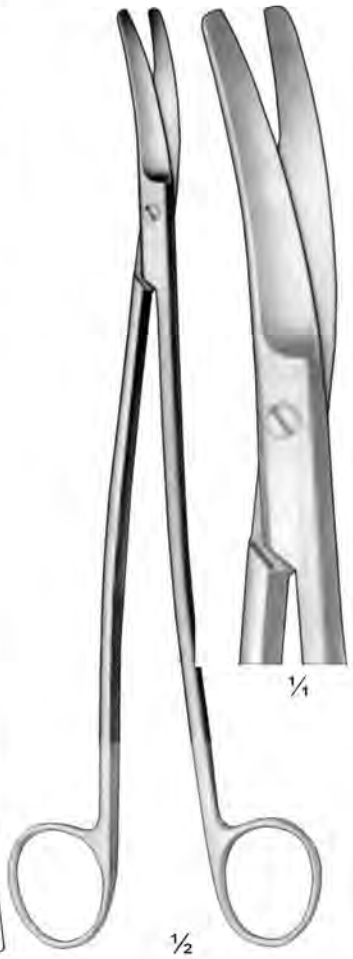

90-07-23 & 90-08-25



**Tungsten Carbide Scheren ; Tijeras de carburo de tungsteno  
 Tungsten Carbide Scissors ; Forbici di carburo di tungsteno  
 Ciseaux en carbure de tungstène ; Tesoura de carboneto de tungstênio**



Mayo  
 91-01-14 To 91-03-23



91-01-14  
 14.5 cm / 5 3/4"



91-02-18  
 18 cm / 7"



91-03-23  
 23 cm / 9"



Mayo  
 91-04-14 To 91-06-23



91-04-14  
 14.5 cm / 5 3/4"

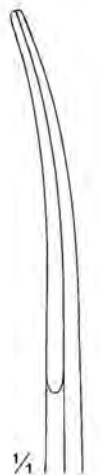

91-05-18  
 18 cm / 7"

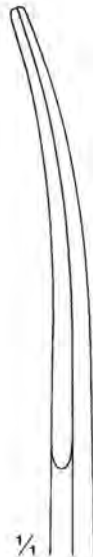

91-06-23  
 23 cm / 9"

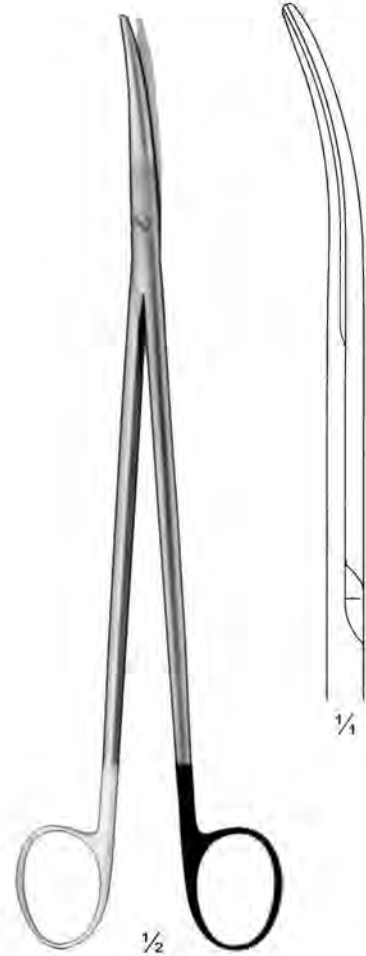

91-07-26  
 26 cm / 10 1/4"  
 One ring black and  
 one goldplated



**Tungsten Carbide Scheren ; Tijeras de carburo de tungsteno  
 Tungsten Carbide Scissors ; Forbici di carburo di tungsteno  
 Ciseaux en carbure de tungstène ; Tesoura de carboneto de tungstênio**



**92-01-15**  
15 cm / 6"

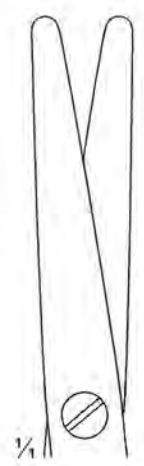

**92-02-17**  
17 cm / 6 3/4"

Mayo-Style  
**92-01-15 & 92-02-17**



**92-03-15**  
15 cm / 6"

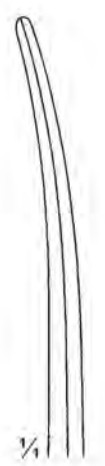

**92-04-17**  
17 cm / 6 3/4"

Mayo-Style  
**92-03-15 & 92-04-17**

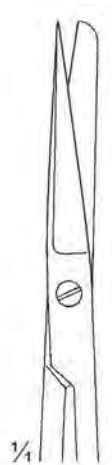

**92-05-12**  
Sh/Bl

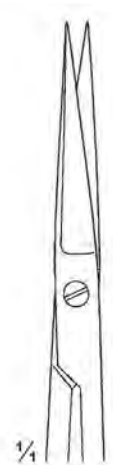

**92-06-12**  
Sh/Sh



**92-07-12**  
Sh/Bl



**92-08-12**  
Sh/Sh

**92-05-12 To 92-08-12**  
12 cm / 4 3/4"

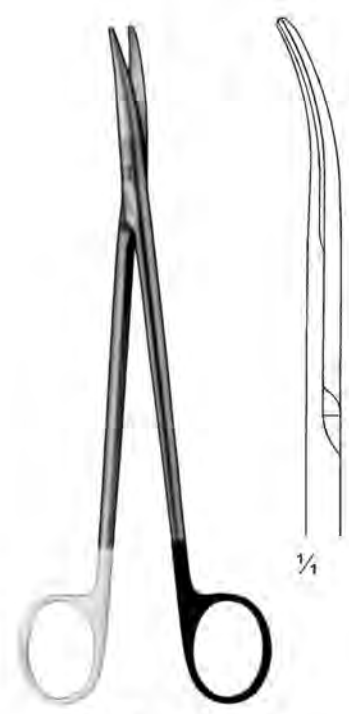

**92-09-18**  
18 cm / 7"  
One ring black and  
one goldplated

Tungsten Carbide Scheren ; Tijeras de carburo de tungsteno  
 Tungsten Carbide Scissors ; Forbici di carburo di tungsteno  
 Ciseaux en carbure de tungstène ; Tesoura de carboneto de tungstênio



Mayo-Harrington  
 93-01-28  
 28 cm / 11"

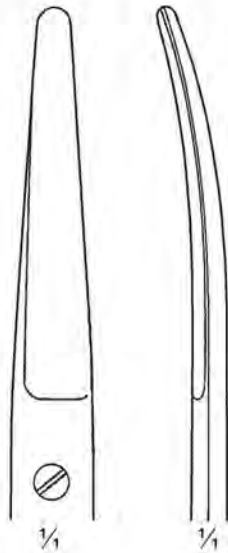

1/4

1/4

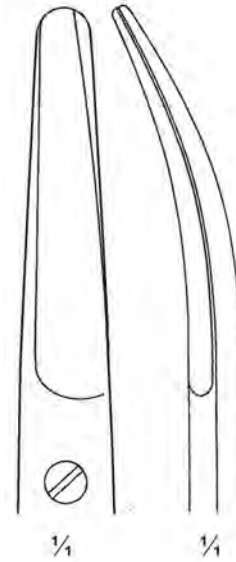

1/4

1/4



Sims  
 93-06-23  
 23 cm / 9"

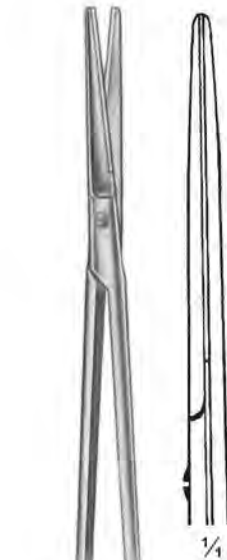

1/4

Mayo-Harrington  
 93-02-20 20 cm / 8"  
 93-03-23 23 cm / 9"



1/4

Mayo-Harrington  
 93-04-20 20 cm / 8"  
 93-05-23 23 cm / 9"



**Tungsten Carbide Scheren ; Tijeras de carburo de tungsteno  
 Tungsten Carbide Scissors ; Forbici di carburo di tungsteno  
 Ciseaux en carbure de tungstène ; Tesoura de carboneto de tungstênio**



Metzenbaum  
 94-01-18 To 94-06-30



94-01-18  
 18 cm / 7"



94-02-20  
 20 cm / 8"



94-03-23  
 23 cm / 9"

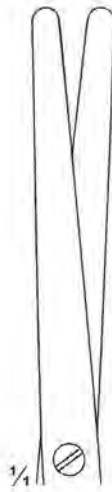

94-04-25  
 25 cm / 10"



94-05-28  
 28 cm / 11"



94-06-30  
 30 cm / 12"



Metzenbaum  
 94-07-18 To 94-12-30  
 BI/BI



94-07-18  
 18 cm / 7"

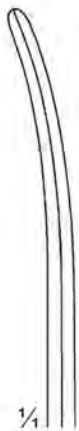

94-08-20  
 20 cm / 8"



94-09-23  
 23 cm / 9"



94-10-10  
 25 cm / 10"



94-11-28  
 28 cm / 11"



94-12-30  
 30 cm / 12"

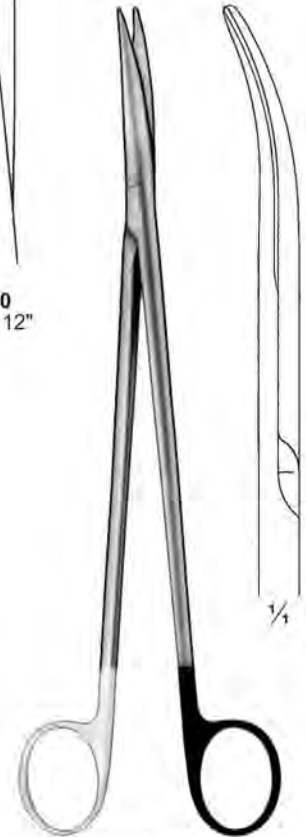

94-13-23  
 23 cm / 9"  
 One ring black and  
 one goldplated



**Tungsten Carbide Scheren ; Tijeras de carburo de tungsteno  
 Tungsten Carbide Scissors ; Forbici di carburo di tungsteno  
 Ciseaux en carbure de tungstène ; Tesoura de carboneto de tungstênio**



Metzenbaum-Fino  
 95-01-14 To 95-06-28



95-01-14  
 14 cm / 5½"



95-02-18  
 18 cm / 7"

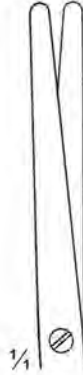

95-03-20  
 20 cm / 8"



95-04-23  
 23 cm / 9"

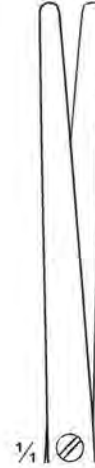

95-05-25  
 25 cm / 10"

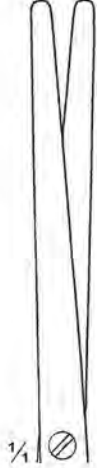

95-06-28  
 28 cm / 11"



Metzenbaum-Fino  
 95-07-14 To 95-12-28  
 BI/BI



95-07-14  
 14 cm / 5½"



95-08-18  
 18 cm / 7"



95-09-20  
 20 cm / 8"



95-10-23  
 23 cm / 9"



95-11-25  
 25 cm / 10"



95-12-28  
 28 cm / 11"



95-13-11  
 11 cm / 4¼"  
 One blade serrated





**Tungsten Carbide Scheren ; Tijeras de carburo de tungsteno  
Tungsten Carbide Scissors ; Forbici di carburo di tungsteno  
Ciseaux en carbure de tungstène ; Tesoura de carboneto de tungstênio**



**96-01-14**  
14 cm / 5½"



**96-02-18**  
18 cm / 7"



**96-03-20**  
20 cm / 8"



**96-04-23**  
23 cm / 9"



**96-05-11**



**96-06-11**

**96-05-11 & 96-06-11**  
11 cm / 4¼"

**Metzenbaum-Fino**  
**96-01-14 To 96-04-23**

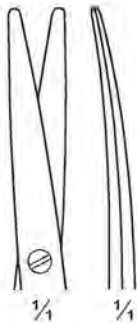
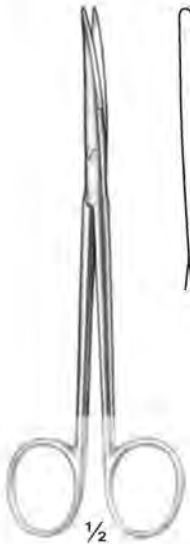

**Metzenbaum-Lahey**  
**96-07-14**  
14 cm / 5¼"

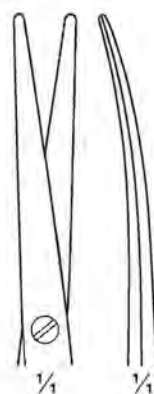
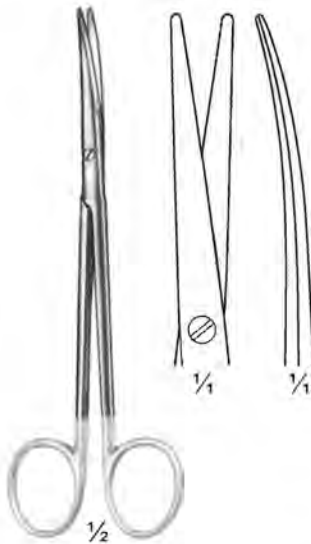

**Toennis-Adson**  
**96-08-18**  
18 cm / 7"

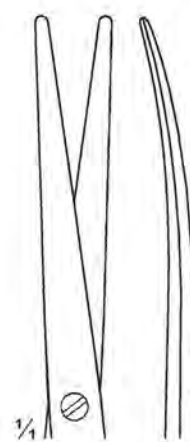

**96-09-20**  
20 cm / 8"

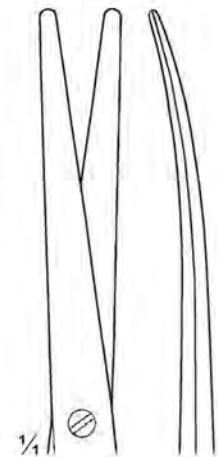

**96-10-23**  
23 cm / 9"

**Metzenbaum**  
**96-09-20 & 96-10-23**



**Tungsten Carbide Scheren ; Tijeras de carburo de tungsteno  
Tungsten Carbide Scissors ; Forbici di carburo di tungsteno  
Ciseaux en carbure de tungstène ; Tesoura de carboneto de tungstênio**



**97-01-14**  
14 cm / 5½"

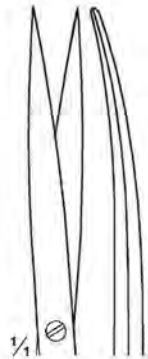

**97-02-18**  
18 cm / 7"

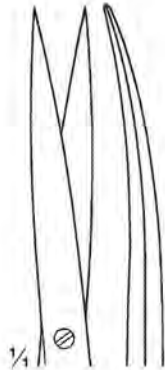

**97-03-20**  
20 cm / 8"

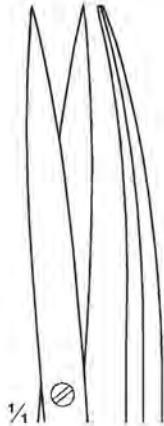

**97-04-23**  
23 cm / 9"

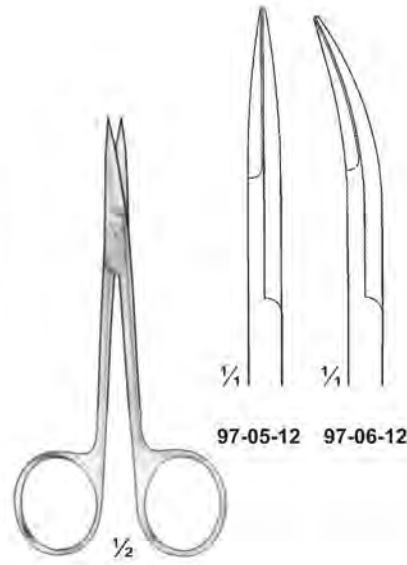

**97-05-12 97-06-12**

**97-05-12 & 97-06-12**  
12 cm / 4¾"

**Metzenbaum-Fino**  
97-01-14 To 97-04-23

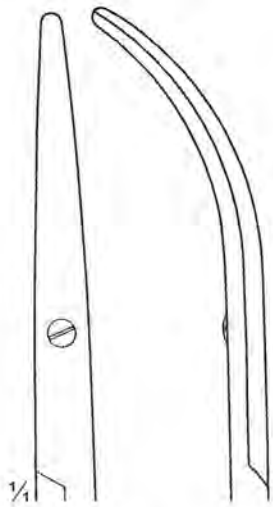

**97-07-20**  
20 cm / 8"

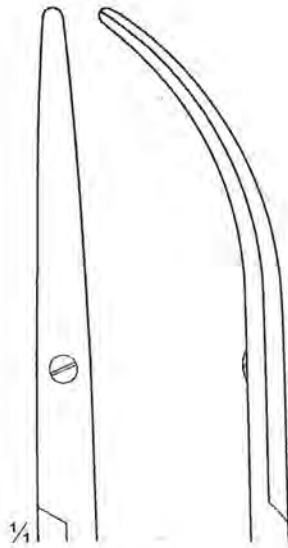

**97-08-23**  
23 cm / 9"

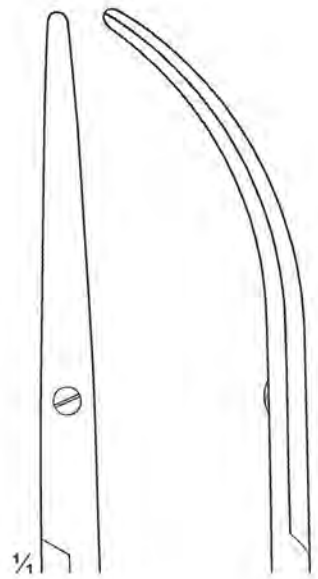

**97-09-28**  
28 cm / 11"

**Metzenbaum-Thorek**  
97-07-20 To 97-09-28



**Tungsten Carbide Scheren ; Tijeras de carburo de tungsteno  
 Tungsten Carbide Scissors ; Forbici di carburo di tungsteno  
 Ciseaux en carbure de tungstène ; Tesoura de carboneto de tungstênio**

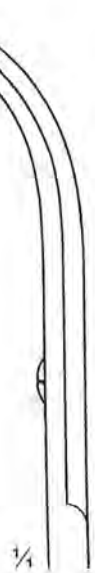
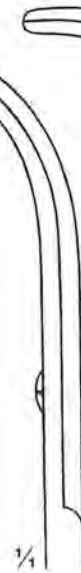
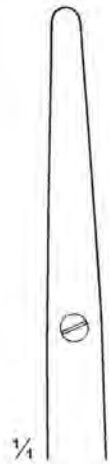
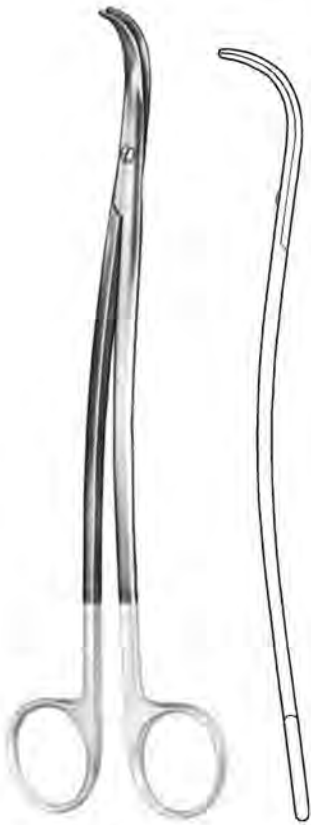

**98-01-20**  
20 cm / 8"

**98-02-23**  
23 cm / 9"

**98-03-25**  
25 cm / 10"

**98-04-28**  
28 cm / 11"

**Metzenbaum-S**  
98-01-20 To 98-04-28

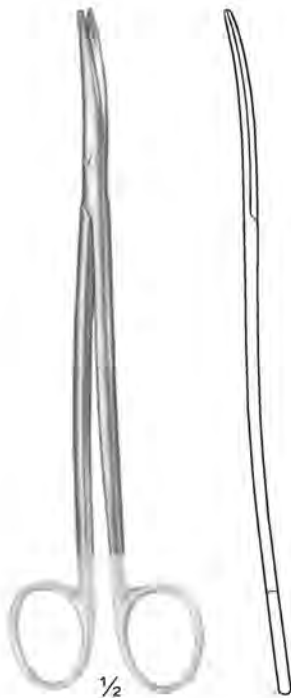

**98-05-18**  
18 cm / 7"

**98-06-20**  
20 cm / 8"

**98-07-23**  
23 cm / 9"

**Metzenbaum-Fino**  
98-05-18 To 98-07-23

Tungsten Carbide Scheren ; Tijeras de carburo de tungsteno  
 Tungsten Carbide Scissors ; Forbici di carburo di tungsteno  
 Ciseaux en carbure de tungstène ; Tesoura de carboneto de tungstênio

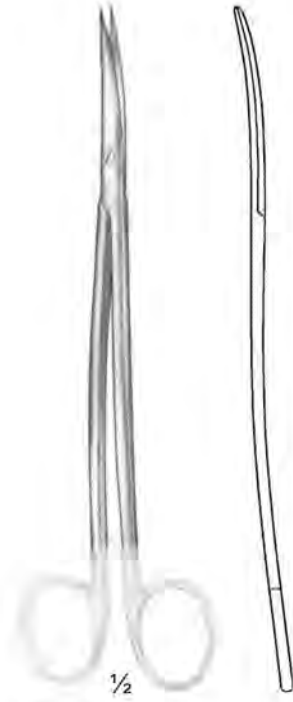

Metzenbaum-Fino  
 99-01-18 To 99-03-23



99-01-18  
 18 cm / 7"

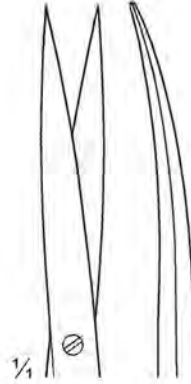

99-02-20  
 20 cm / 8"

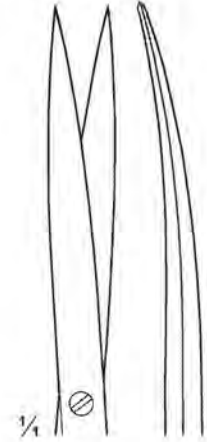

99-03-23  
 23 cm / 9"

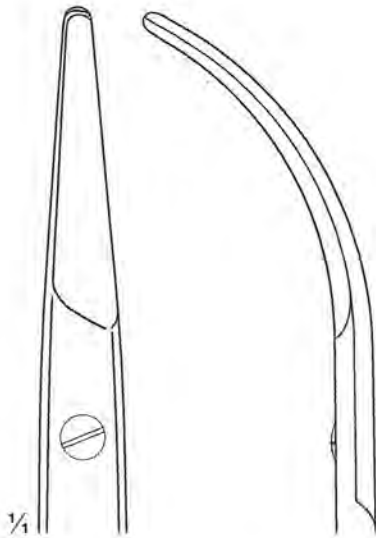

99-04-23  
 23 cm / 9"

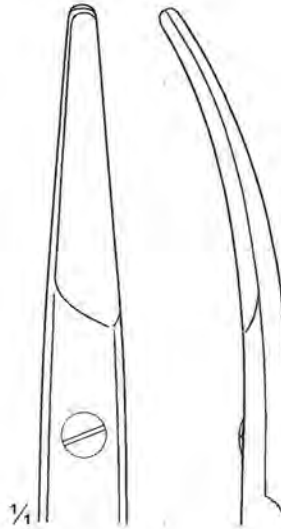

99-05-23  
 23 cm / 9"



Parametrium  
 99-04-23 & 99-05-23



**Tungsten Carbide Scheren ; Tijeras de carburo de tungsteno  
Tungsten Carbide Scissors ; Forbici di carburo di tungsteno  
Ciseaux en carbure de tungstène ; Tesoura de carboneto de tungstênio**

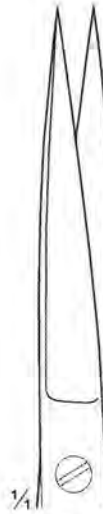

Standard  
100-01-15 To 100-06-18

100-01-15  
100-07-15  
15 cm / 6"

100-02-16  
100-08-16  
16.5 cm / 6½"

100-03-18  
100-09-18  
18.5 cm / 7½"

100-04-15  
100-10-15  
15 cm / 6"

100-05-16  
100-11-16  
16.5 cm / 6½"

100-06-18  
100-12-18  
18.5 cm / 7½"

Standard  
100-07-15 To 100-12-18

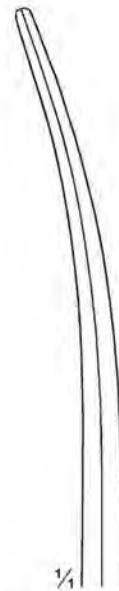
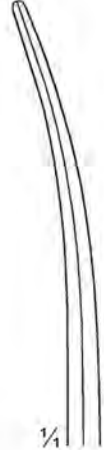
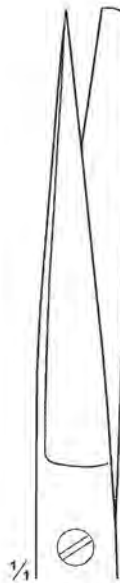
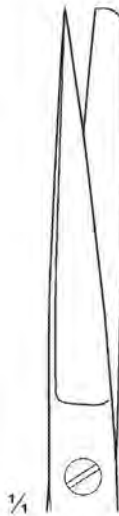

Standard  
100-13-15 To 100-18-18

100-13-15  
100-19-15  
15 cm / 6"

100-14-16  
100-20-16  
16.5 cm / 6½"

100-15-18  
100-21-18  
18.5 cm / 7½"

100-16-15  
100-22-15  
15 cm / 6"

100-17-16  
100-23-16  
16.5 cm / 6½"

100-18-18  
100-24-18  
18.5 cm / 7½"

Standard  
100-19-15 To 100-24-18



**Tungsten Carbide Scheren ; Tijeras de carburo de tungsteno  
 Tungsten Carbide Scissors ; Forbici di carburo di tungsteno  
 Ciseaux en carbure de tungstène ; Tesoura de carboneto de tungstênio**

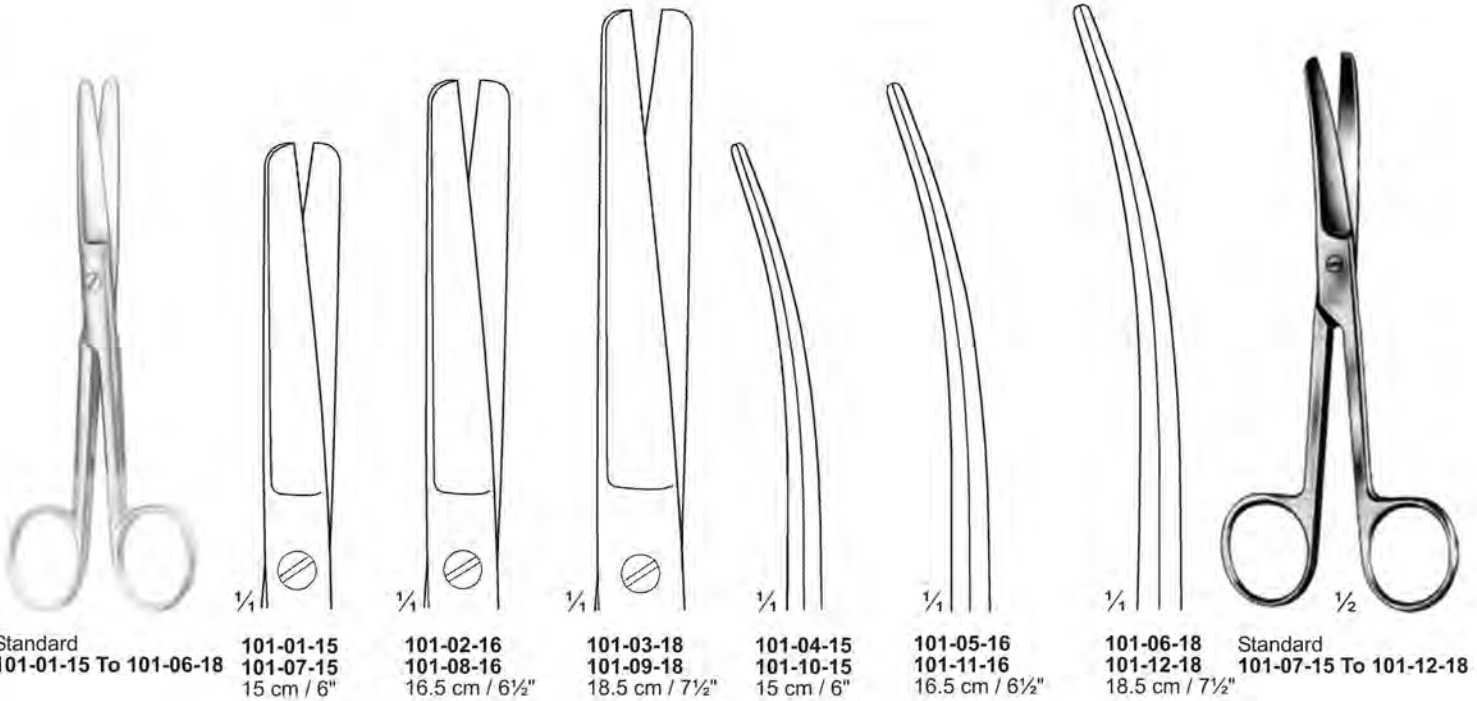

Standard  
 101-01-15 To 101-06-18

101-01-15  
 101-07-15  
 15 cm / 6"

101-02-16  
 101-08-16  
 16.5 cm / 6½"

101-03-18  
 101-09-18  
 18.5 cm / 7½"

101-04-15  
 101-10-15  
 15 cm / 6"

101-05-16  
 101-11-16  
 16.5 cm / 6½"

101-06-18  
 101-12-18  
 18.5 cm / 7½"

Standard  
 101-07-15 To 101-12-18

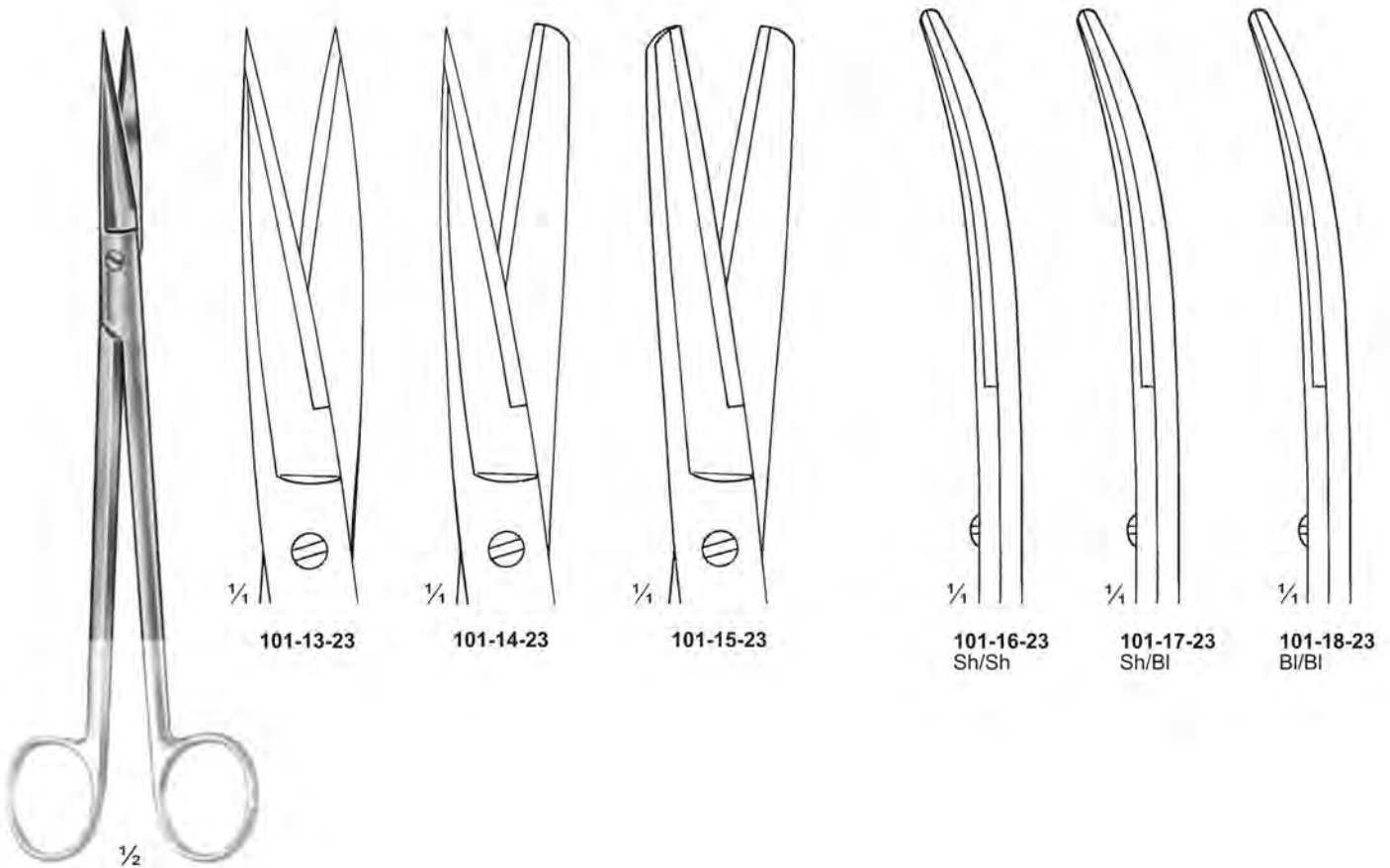

101-13-23

101-14-23

101-15-23

101-16-23  
 Sh/Sh

101-17-23  
 Sh/BI

101-18-23  
 BI/BI

Sims  
 101-13-23 To 101-18-23  
 23 cm / 9"

**Tungsten Carbide Scheren ; Tijeras de carburo de tungsteno  
Tungsten Carbide Scissors ; Forbici di carburo di tungsteno  
Ciseaux en carbure de tungstène ; Tesoura de carboneto de tungstênio**

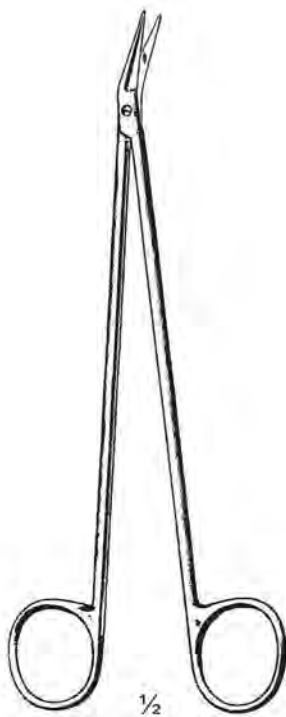

Potts-De Martel  
102-01-25 To 102-03-60



102-01-25  
19 cm / 7½"  
25°



102-02-40  
19 cm / 7½"  
40°



102-03-60  
19 cm / 7½"  
60°



Dietrich  
102-04-25 To 102-08-125



102-04-25  
18 cm / 7"  
25°



102-05-45  
18 cm / 7"  
45°

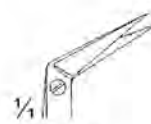

102-06-60  
18 cm / 7"  
60°



102-07-90  
17 cm / 6¾"  
90°



102-08-125  
17 cm / 6¾"  
125°



Dietrich  
102-09-17  
17 cm / 6¾"

**Tungsten Carbide Scheren ; Tijeras de carburo de tungsteno  
 Tungsten Carbide Scissors ; Forbici di carburo di tungsteno  
 Ciseaux en carbure de tungstène ; Tesoura de carboneto de tungstênio**



103-01-14

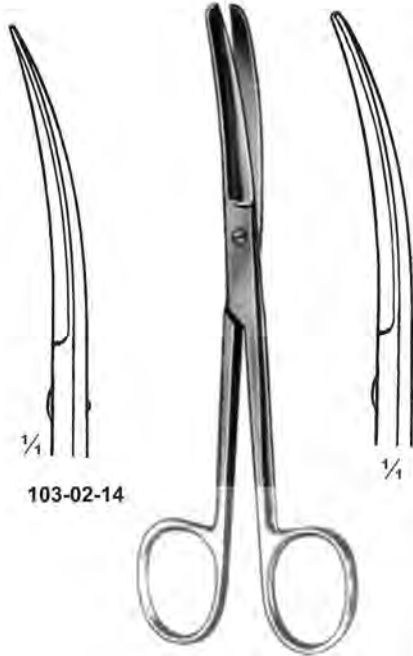

103-02-14

Deaver  
 103-01-14 & 103-02-14  
 14 cm / 5½"

Deaver  
 103-03-14  
 14 cm / 5½"

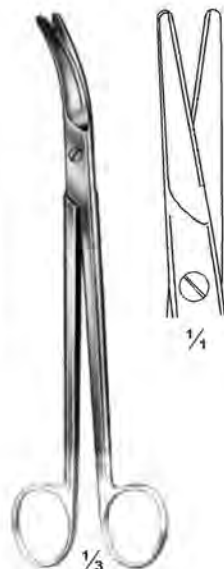

103-04-22 & 103-05-23

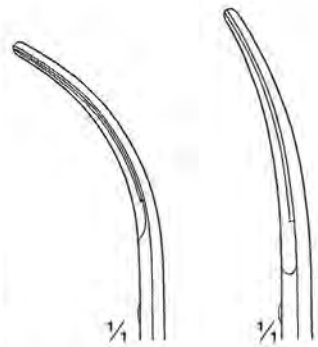

103-04-22 22.5 cm / 8¾"  
 103-05-23 23 cm / 9"

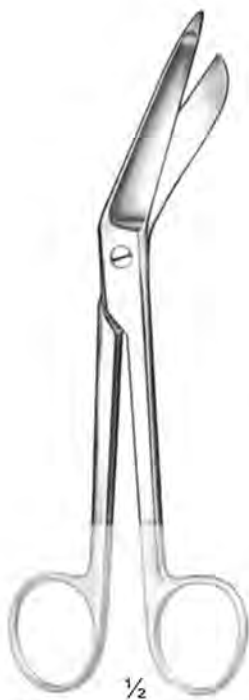

Lister  
 103-06-14 14 cm / 5½"  
 103-07-15 15 cm / 6"  
 103-08-18 18 cm / 7"  
 103-09-20 20 cm / 8"  
 103-10-23 23 cm / 9"

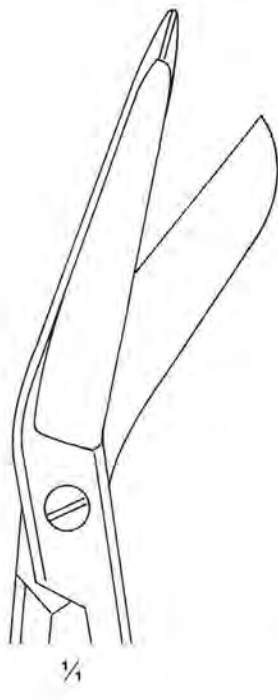

1/4



Bruns  
 103-11-24  
 24 cm / 9½"

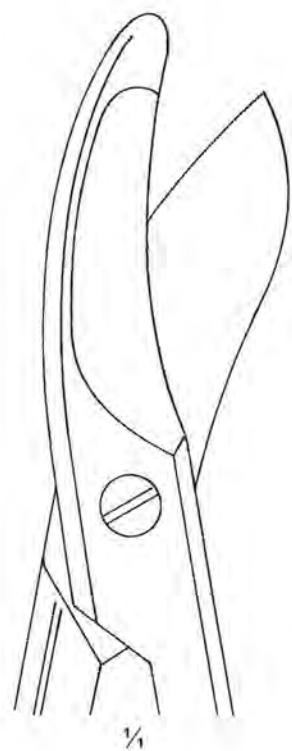

1/4



**Verbandscheren ; Tijeras para vendajes  
Bandage Scissors ; Forbici per bendaggi  
Ciseaux pour pansements ; Tesouras para bandagem**



**104-01-16**  
16 cm / 6 1/4"

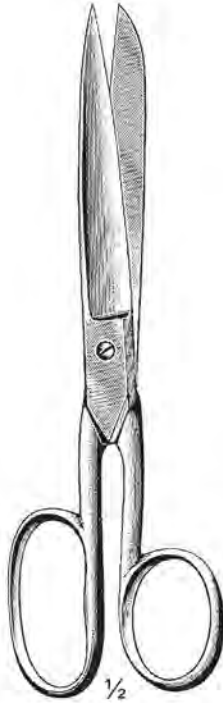

Smith  
**104-02-15** 15 cm / 6"  
**104-03-18** 18 cm / 7"  
**104-04-20** 20 cm / 8"  
**104-05-23** 23 cm / 9"



Smith  
**104-06-15** 15 cm / 6"  
**104-07-18** 18 cm / 7"  
**104-08-20** 20 cm / 8"  
**104-09-23** 23 cm / 9"

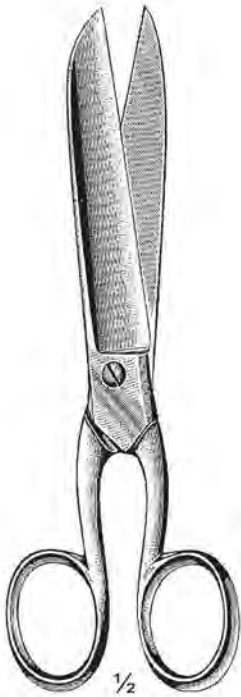

Schweizer  
**104-10-18** 18 cm / 7"  
**104-11-20** 20 cm / 8"  
**104-12-23** 23 cm / 9"

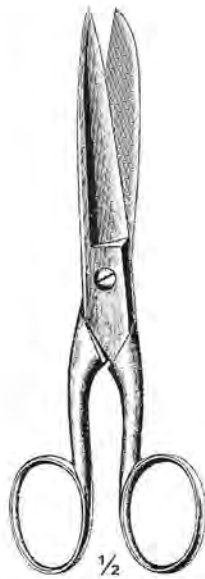

**104-13-10** 10 cm / 4"  
**104-14-12** 12.5 cm / 5"  
**104-15-15** 15 cm / 6"  
**104-16-18** 18 cm / 7"  
**104-17-20** 20 cm / 8"



Lange  
**104-18-18** 18 cm / 7"  
**104-19-20** 20 cm / 8"



**104-20-20** 20 cm / 8"  
**104-21-23** 23 cm / 9"  
**104-22-25** 25 cm / 10"

**Verbandscheren ; Tijeras para vendajes  
Bandage Scissors ; Forbici per bendaggi  
Ciseaux pour pansements ; Tesouras para bandagem**



Lister  
**105-01-14** 14 cm / 5½"  
**105-02-16** 16 cm / 6¼"  
**105-03-18** 18 cm / 7"  
**105-04-20** 20 cm / 8"



½  
**105-05-16** 16.5 cm / 6½"  
**105-06-18** 18 cm / 7"



½  
**105-07-14** 14 cm / 5½"  
**105-08-17** 17 cm / 6¾"



½  
 Knowles  
**105-09-14**  
 14.5 cm / 5¾"



½  
 Knowles  
**105-10-14** 14 cm / 5½"  
**105-11-15** 15 cm / 6"

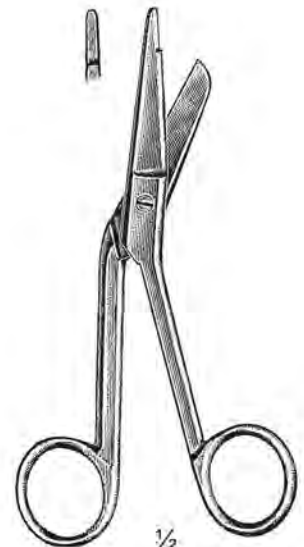

½  
 Lister  
**105-12-15**  
 15 cm / 6"  
 Sheffield Pattern

**Verbandscheren ; Tijeras para vendajes  
Bandage Scissors ; Forbici per bendaggi  
Ciseaux pour pansements ; Tesouras para bandagem**

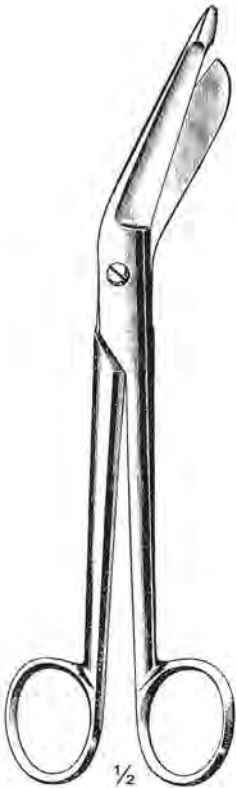

Lister  
**106-01-11** 11.5 cm / 4½"  
**106-02-14** 14 cm / 5½"  
**106-03-15** 15 cm / 6"  
**106-04-18** 18 cm / 7"  
**106-05-20** 20 cm / 8"  
**106-06-23** 23 cm / 9"



Lister  
**106-07-09** 9 cm / 3½"  
**106-08-10** 10.5 cm / 4¼"  
**106-09-11** 11.5 cm / 4½"  
**106-10-14** 14 cm / 5½"  
**106-11-15** 15 cm / 6"  
**106-12-17** 17 cm / 6¾"  
**106-13-18** 18 cm / 7"  
**106-14-20** 20 cm / 8"  
**106-15-23** 23 cm / 9"

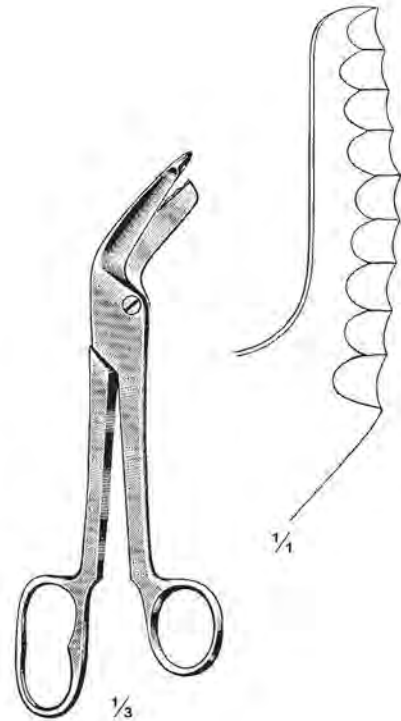

Tornado  
**106-16-24**  
 24 cm / 9½"



Bergmann  
**106-17-15** 15 cm / 6"  
**106-18-18** 18 cm / 7"  
**106-19-20** 20 cm / 8"  
**106-20-23** 23 cm / 9"



Esmarch  
**106-21-18** 18 cm / 7"  
**106-22-20** 20 cm / 8"  
**106-23-23** 23 cm / 9"

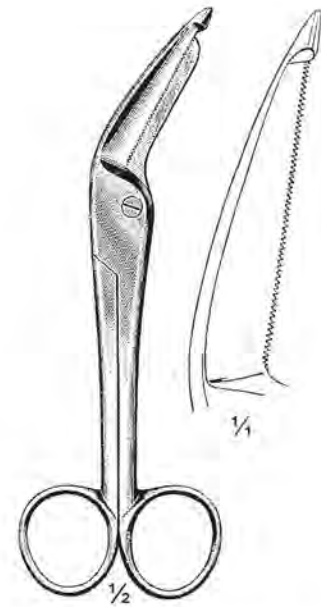

Lister Excentric  
**106-24-16** 16 cm / 6¼"  
**106-25-19** 19 cm / 7½"

**Verbandscheren ; Tijeras para vendajes  
Bandage Scissors ; Forbici per bendaggi  
Ciseaux pour pansements ; Tesouras para bandagem**



Lister  
107-01-14 14 cm / 5½"  
107-02-18 18 cm / 7"  
Available in different colours



Lister  
107-03-14  
14.5 cm / 5¾"  
Available in different colours

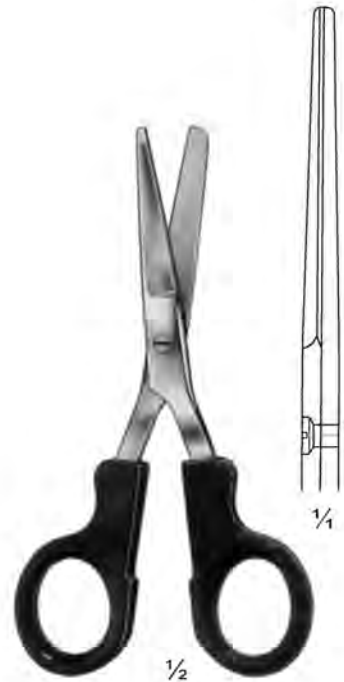

107-04-14  
14.5 cm / 5¾"  
Available in different colours



Lorenz  
107-05-23  
23 cm / 9"



Braun-Stadler  
107-06-23  
23 cm / 9"

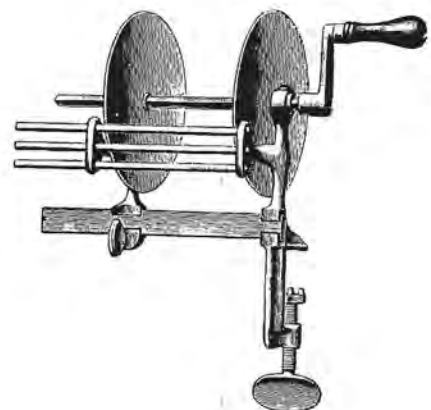

107-07-20  
Adjustable to 20 cm / 8"

Verbandscheren ; Tijeras para vendajes  
 Bandage Scissors ; Forbici per bendaggi  
 Ciseaux pour pansements ; Tesouras para bandagem



108-01-20  
 20 cm / 8"



$\frac{1}{3}$   
 108-02-30  
 30 cm / 12"



Gauze  
 108-03-18 18 cm / 7"  
 108-04-20 20 cm / 8"  
 108-05-23 23 cm / 9"  
 108-06-25 25 cm / 10"  
 108-07-30 30 cm / 12"



Taylor  
 108-08-18 18 cm / 7"  
 108-09-20 20 cm / 8"  
 108-10-23 23 cm / 9"  
 108-11-25 25 cm / 10"  
 108-12-30 30 cm / 12"

Gipsscheren ; Tijeras para vendajes  
 Plaster-of-Paris Shears ; Forbici per gessi  
 Ciseaux pour plâtre ; Tesouras para gessos



1/4



1/2  
 Stille-Mini  
 109-01-20  
 20 cm / 8"

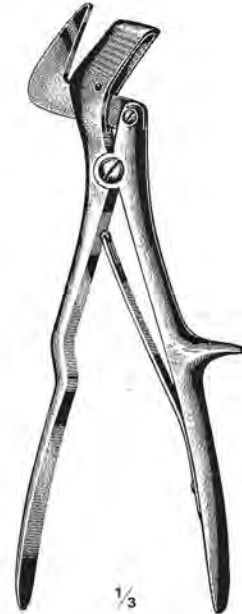

1/3  
 Stille  
 109-02-24  
 24 cm / 9 1/2"



1/3

Stille  
 109-03-37 37 cm / 14 1/2"  
 109-04-42 42 cm / 16 1/2"

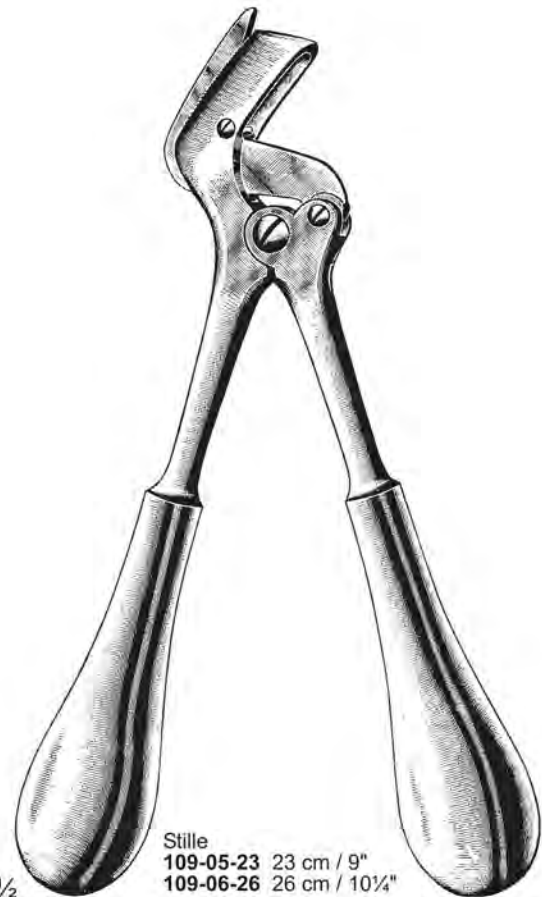

1/2

Stille  
 109-05-23 23 cm / 9"  
 109-06-26 26 cm / 10 1/4"

**Verbandscheren ; Tijeras para vendajes  
Bandage Scissors ; Forbici per bendaggi  
Ciseaux pour pansements ; Tesouras para bandagem**

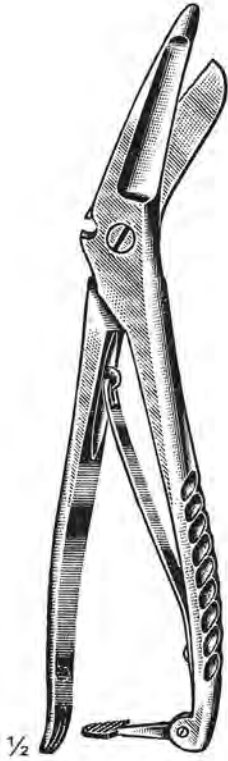

1/2  
Commander  
110-01-21  
21 cm / 8 1/4"



1/2  
Seutin  
110-02-21 21 cm / 8 1/4"  
110-03-23 23 cm / 9"



1/2  
Seutin  
110-04-21 21 cm / 8 1/4"  
110-05-23 23 cm / 9"



1/3  
Stille  
110-06-26  
26 cm / 10 1/4"



1/3



1/3  
Stille  
110-07-37 37 cm / 14 1/2"  
110-08-42 42 cm / 16 1/2"

Verbandscheren ; Tijeras para vendajes  
 Bandage Scissors ; Forbici per bendaggi  
 Ciseaux pour pansements ; Tesouras para bandagem



Hercules  
 111-01-19  
 19 cm / 7½"



Moleskin  
 111-02-19 19 cm / 7½" Str  
 111-03-19 19 cm / 7½" Cur

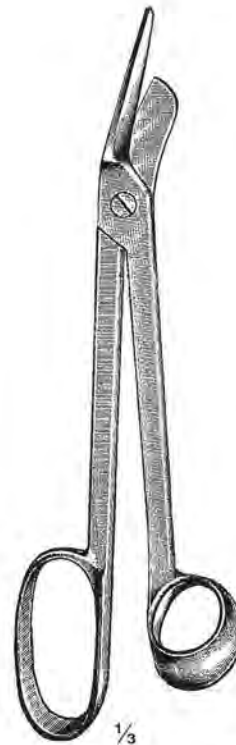

1/3  
 Guy  
 111-04-29  
 29 cm / 11½"

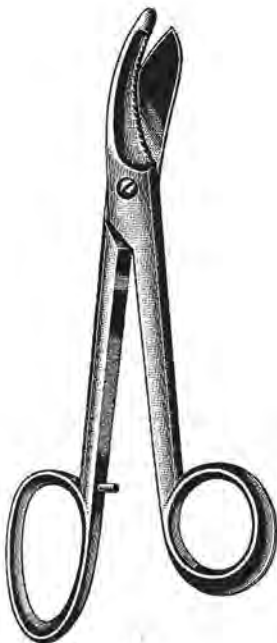

Bruns  
 111-05-23  
 23.5 cm / 9¼"



Bruns  
 111-06-23  
 23.5 cm / 9¼"



2/5  
 Haglund-  
 Stille  
 111-07-28  
 28 cm / 11"



**Gipsabreißzangen ; Pinzas para quitar yesos  
Plaster Breakers ; Pinze per rompere gessi  
Pincès à déplâtre : Pinças para quebrar gessos**



Farabeuf  
112-01-18 18 cm / 7"  
112-02-20 20 cm / 8"  
112-03-24 24 cm / 9½"



Wolff  
112-04-18  
18 cm / 7"



Wolff  
112-05-24  
24 cm / 9½"

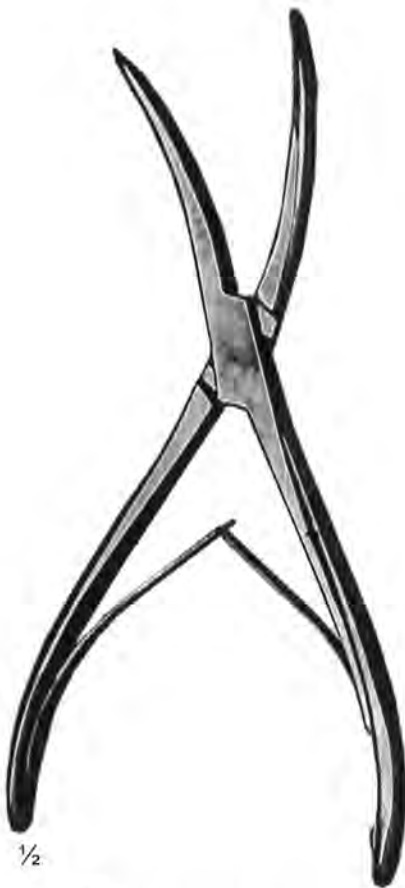

Wolff  
112-06-18 18 cm / 7"  
112-07-20 20 cm / 8"  
112-08-22 22 cm / 8¾"  
112-09-24 24 cm / 9½"  
112-10-26 26 cm / 10¼"



Mason  
112-11-18 18 cm / 7"  
112-12-20 20 cm / 8"  
112-13-23 23 cm / 9"



112-14-30  
30 cm / 12"

**Gipsspreizer ; Separadores para yesos  
Plaster Cast Spreaders ; Divaricatori bei gessi  
Épandeurs à plâtre ; Espalhador para gessos**

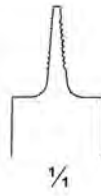
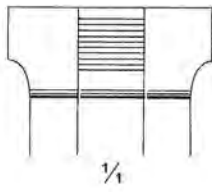
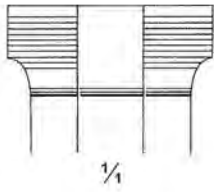

Walton  
113-01-24  
24 cm / 9 1/2"



Hennig  
113-02-40 40 mm Jaws  
113-03-60 60 mm Jaws  
28 cm / 11"



Beeson  
113-04-30  
30 cm / 12"

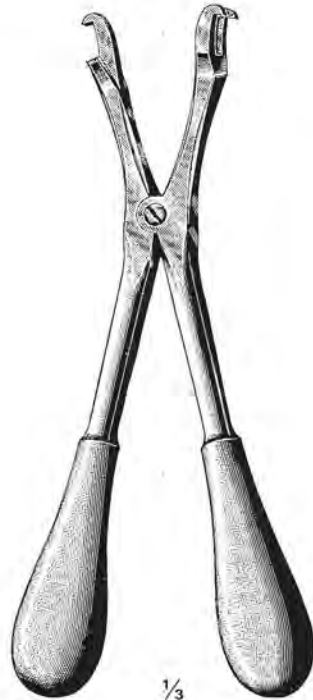

Haglund-Stille  
113-05-28  
28 cm / 11"



Knorr  
113-06-30  
30 cm / 12"

Gipsmesser ; Cuchillos para yessos  
 Plaster Knives ; Coltelli per gessi  
 Couteaux à plâtre ; Facas para gessos



1/2  
 Korte  
 114-01-18  
 18 cm / 7"



1/2  
 Hopkins  
 114-02-20  
 20 cm / 8"



1/2  
 Hopkins  
 114-03-20  
 20 cm / 8"



1/2  
 114-04-20  
 20 cm / 8"

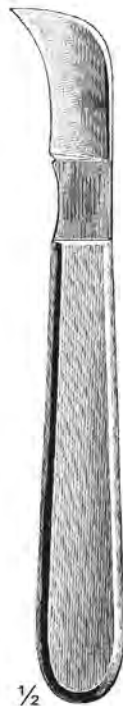

1/2  
 Reiner  
 114-05-18  
 18.5 cm / 7 1/4"



1/2  
 Esmarch  
 114-06-18  
 18 cm / 7"



1/2  
 114-07-21  
 21 cm / 8 1/4"

Gipsmesser ; Cuchillos para yessos  
 Plaster Knives ; Coltelli per gessi  
 Couteaux à plâtre ; Facas para gessos



1/2  
 Wigmore  
 115-01-19  
 19 cm / 7 1/2"

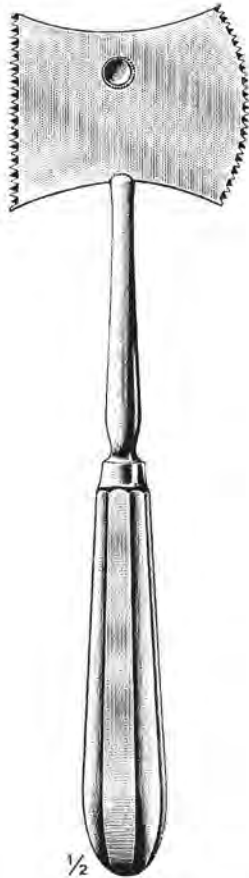

1/2  
 Kaulich  
 115-02-23  
 23 cm / 9"

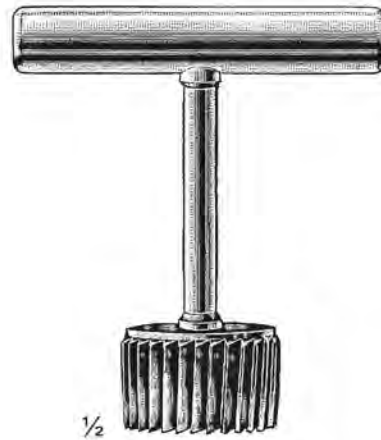

1/2  
 Galt  
 115-03-00

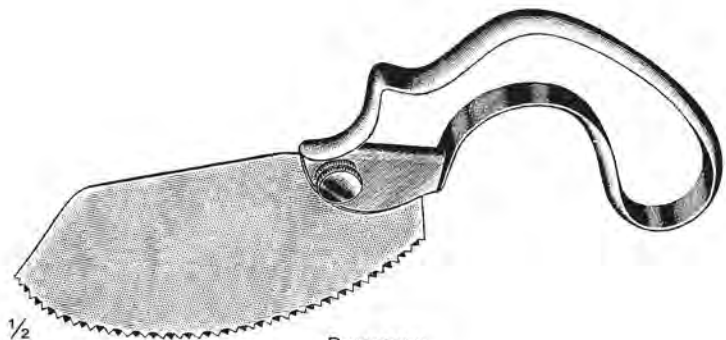

1/2  
 Bergmann  
 115-04-19  
 19 cm / 7 1/2"

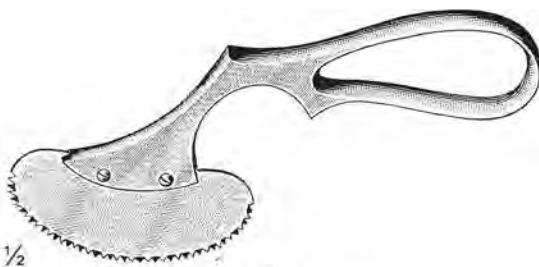

1/2  
 Engle  
 115-05-16  
 16 cm / 6 1/4"



1/2  
 Bergmann  
 115-06-18  
 18 cm / 7"

**Amputationssägen ; Sierras para amputación  
Amputation Saws ; Seghe per amputazione  
Scies à amputation ; Cerras para amputação**



1/2

**Charriere**

Blade size

- 116-01-12 12.5 cm / 5"
- 116-02-18 18 cm / 7"
- 116-03-21 21 cm / 8 1/4"
- 116-04-24 24 cm / 9 1/2"
- 116-05-27 27 cm / 10 1/2"
- 116-06-30 30 cm / 12"

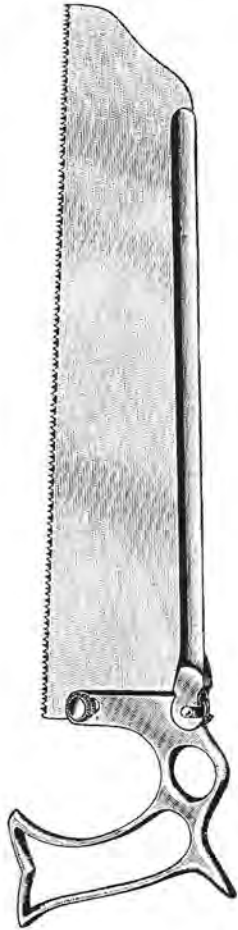

**Weiss**

Blade size

- 116-07-20 20 cm / 8"
- 116-08-23 23 cm / 9"
- 116-09-25 25 cm / 10"
- 116-10-30 30 cm / 12"

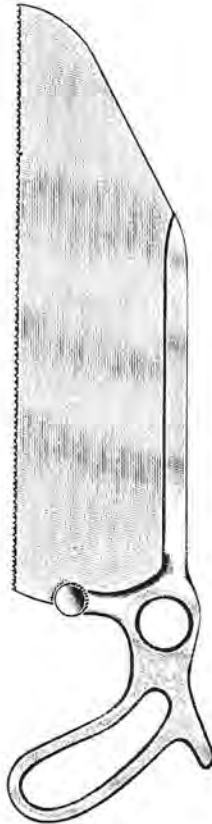

**Satterlee**

Blade size

- 116-11-20 20 cm / 8"
- 116-12-22 22 cm / 8 3/4"
- 116-13-25 25 cm / 10"
- 116-14-30 30 cm / 12"



Blade size

- 116-15-20 20 cm / 8"
- 116-16-23 23 cm / 9"
- 116-17-25 25 cm / 10"
- 116-18-30 30 cm / 12"

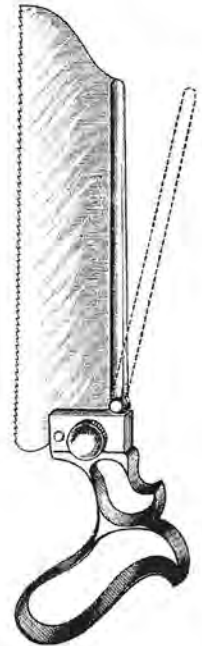

**Hinged Back**

Blade size

- 116-19-20 20 cm / 8"
- 116-20-22 22 cm / 8 3/4"
- 116-21-25 25 cm / 10"
- 116-22-30 30 cm / 12"

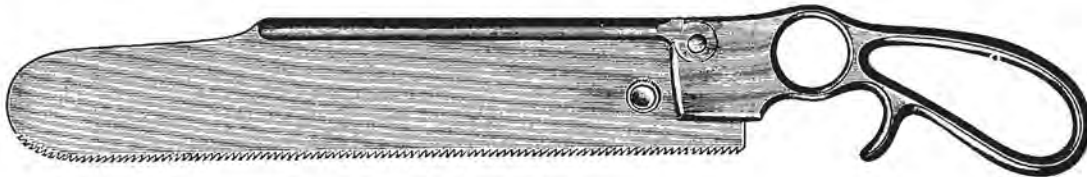

**Detachable**

Blade size

- 116-23-12 12.5 cm / 5"
- 116-24-18 18 cm / 7"
- 116-25-21 21 cm / 8 1/4"
- 116-26-24 24 cm / 9 1/2"
- 116-27-28 28 cm / 11"
- 116-28-33 33 cm / 13 1/4"

**Amputationssägen ; Sierras para amputación  
Amputation Saws ; Seghe per amputazione  
Scies à amputation ; Cerras para amputação**

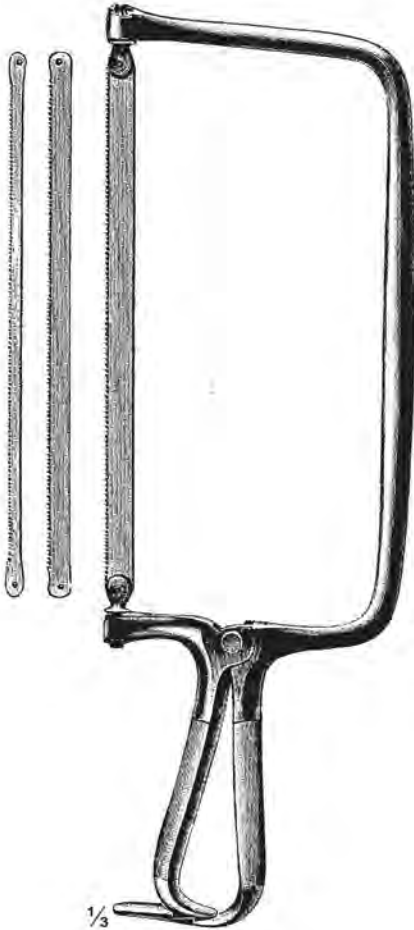

1/3  
Collin  
117-01-33  
33 cm / 13 1/4"  
With 3 blades  
Blades width 6, 8, 12 mm  
117-02-35  
35 cm / 14"  
With 4 blades  
Blades width 4, 5, 8, 12 mm



1/4  
Charriere  
117-03-33 33 cm / 13 1/4"  
117-04-35 35 cm / 14"  
117-05-45 45 cm / 18"  
With 2 blades  
Blades width 12, 15 mm

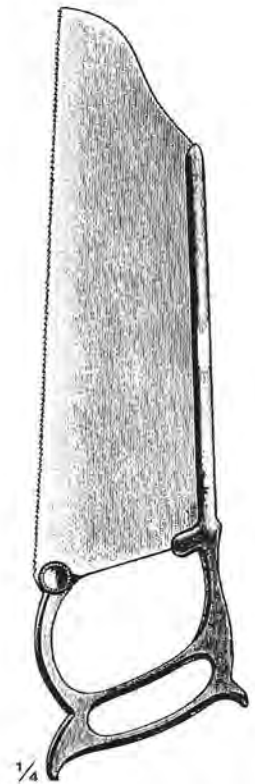

1/4  
Barker  
Blade size  
117-06-20 20 cm / 8"  
117-07-22 22 cm / 8 3/4"  
117-08-25 25 cm / 10"  
117-09-30 30 cm / 12"

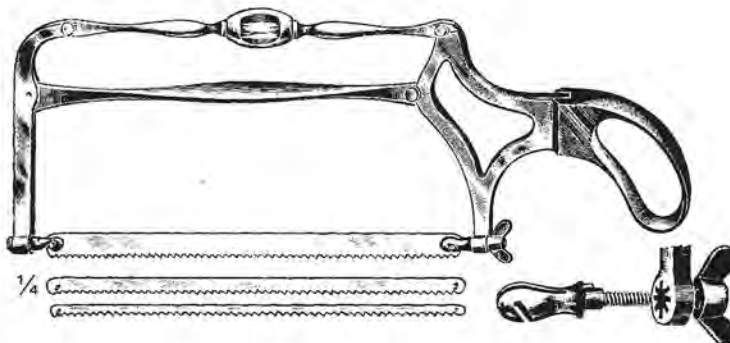

1/4  
Butcher  
117-10-37 37 cm / 14 1/2"  
117-11-39 39 cm / 15 1/2"  
With 3 blades  
Blades width 8, 10, 12 mm

**Amputationssägen ; Sierras para amputación  
Amputation Saws ; Seghe per amputazione  
Scies à amputation ; Cerras para amputação**

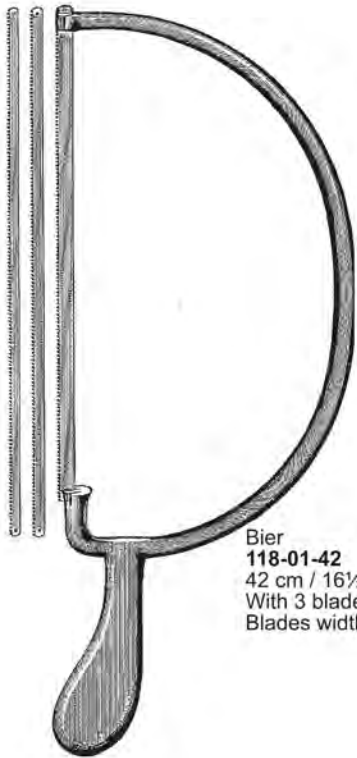

Bier  
118-01-42  
42 cm / 16½"  
With 3 blades  
Blades width 3, 5, 7 mm

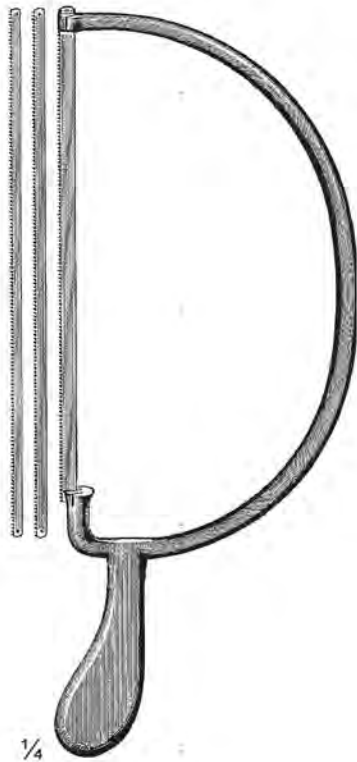

1/4  
Helferich-Bier  
118-02-39  
39 cm / 15½"  
With 3 blades  
Blades width 3, 5, 7 mm

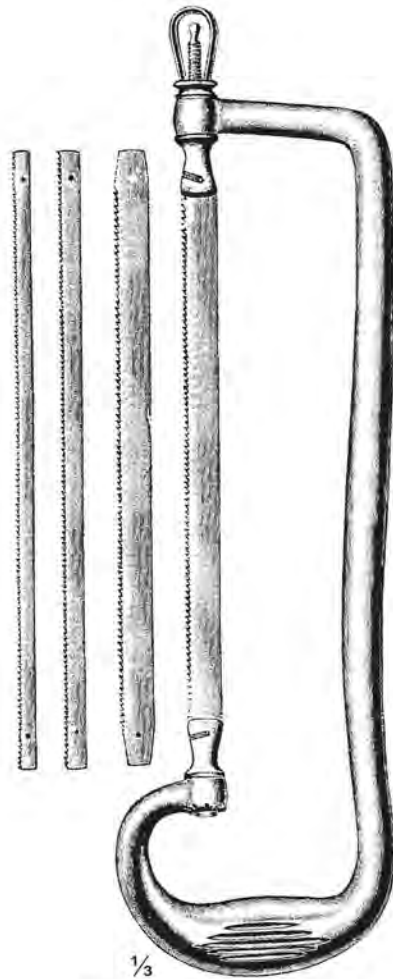

1/3  
Rust  
118-03-39 39 cm / 15½"  
118-04-42 42 cm / 16¾"  
With 4 blades  
Blades width 4, 6, 12, 15 mm

**Amputationssägen ; Sierras para amputación  
Amputation Saws ; Seghe per amputazione  
Scies à amputation ; Cerras para amputação**



1/2  
**119-01-24**  
24 cm / 9 1/2"



1/2  
Langenbeck  
**119-02-23**  
23 cm / 9"



1/2  
Langenbeck  
**119-03-23**  
23 cm / 9"



1/2  
Bruns  
**119-04-21**  
21 cm / 8 1/4"



1/3  
Lindemann  
**119-05-20**  
20 cm / 8"



1/1  
Gigli  
**119-06-30** 30 cm / 12"  
**119-07-40** 40 cm / 15 1/4"  
**119-08-50** 50 cm / 19 1/4"



1/1  
Gigli  
**119-09-30** 30 cm / 12"  
**119-10-40** 40 cm / 15 1/4"  
**119-11-50** 50 cm / 19 1/4"



1/1  
Olivecrona  
**119-12-30** 30 cm / 12"  
**119-13-40** 40 cm / 15 1/4"  
**119-14-50** 50 cm / 19 1/4"



1/2  
**119-15-05**  
5 cm / 2"  
Hook handle  
for wire saws



Maniküre, Pediküre ; Manicura, pedicura  
 Manicure, Pedicure ; Manicure, pedicure  
 Manicure, pedicure ; Manicure, pedicure



120-01-13 13 cm / 5 1/8"  
 120-02-14 14.5 cm / 5 3/4"

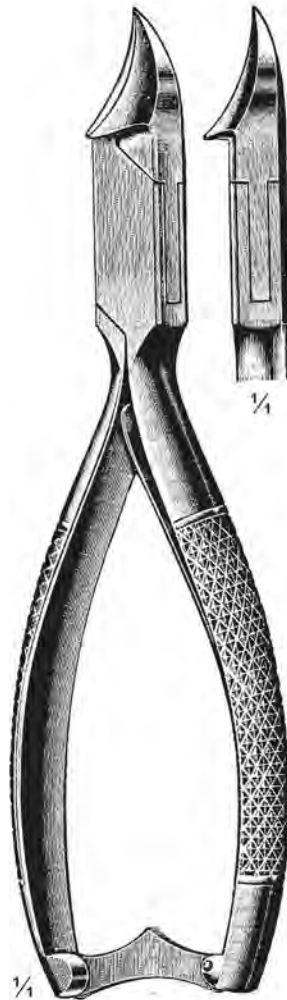

120-03-12 12 cm / 4 3/4"  
 120-04-13 13.5 cm / 5 1/4"  
 120-05-15 15 cm / 6"



120-06-11 11 cm / 4 1/4"  
 120-07-13 13 cm / 5 1/8"  
 120-08-14 14 cm / 5 1/2"  
 120-09-15 15 cm / 6"



120-10-10  
 10 cm / 4"

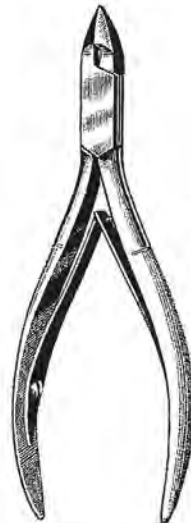

120-11 To 120-13

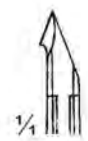

120-11-10  
 10 cm / 4"



120-12-11  
 11.5 cm / 4 1/2"



120-13-12  
 12.5 cm / 5"

**Maniküre, Pediküre ; Manicura, pedicura  
 Manicure, Pedicure ; Manicure, pedicura  
 Manicure, pedicura ; Manicure, pedicura**

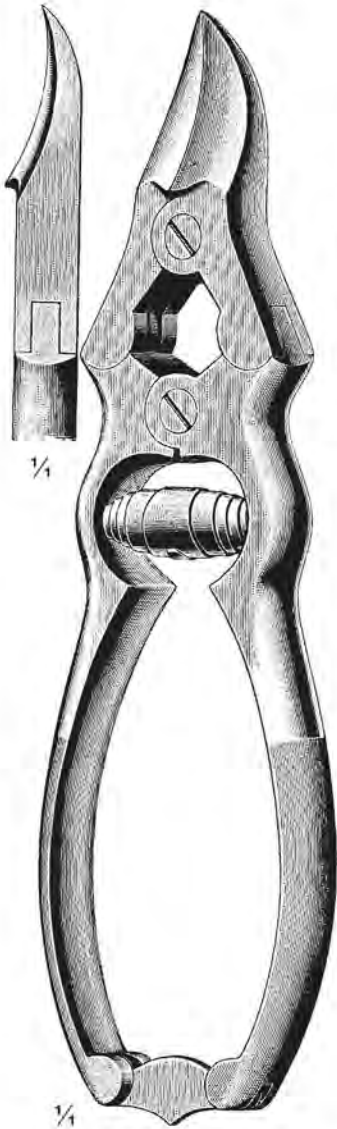

**121-01-15**  
15 cm / 6"



$\frac{1}{2}$   
**121-02-12** 12 cm / 4 $\frac{3}{4}$ "  
**121-03-13** 13 cm / 5 $\frac{1}{8}$ "  
**121-04-15** 15 cm / 6"



$\frac{1}{2}$   
**121-05-12** 12 cm / 4 $\frac{3}{4}$ "  
**121-06-13** 13 cm / 5 $\frac{1}{8}$ "  
**121-07-15** 15 cm / 6"

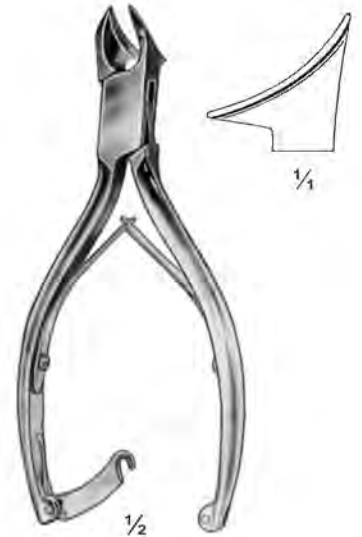

$\frac{1}{2}$   
**121-08-14**  
14 cm / 5 $\frac{1}{2}$ "



**121-09-11** 11.5 cm / 4 $\frac{1}{2}$ "  
**121-10-13** 13 cm / 5 $\frac{1}{8}$ "



$\frac{1}{2}$   
**121-11-14**  
14 cm / 5 $\frac{1}{2}$ "



$\frac{1}{4}$   
 llic  
**121-12-13**  
13 cm / 5 $\frac{1}{8}$ "

**Maniküre, Pediküre ; Manicura, pedicura  
Manicure, Pedicure ; Manicura, pedicura  
Manicure, pedicure ; Manicura, pedicura**

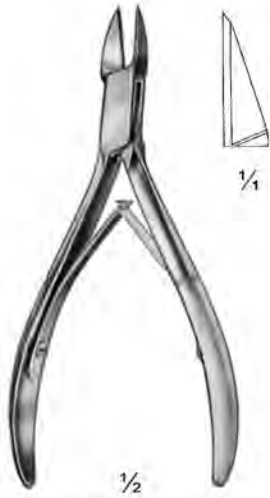

**122-01-13** 13 cm / 5 1/8"  
**122-02-15** 15 cm / 6"



**122-03-11**  
11.5 cm / 4 1/2"



**122-04-11** 11 cm / 4 1/4"  
**122-05-13** 13 cm / 5 1/8"



**122-06-10**  
10.5 cm / 4 1/4"

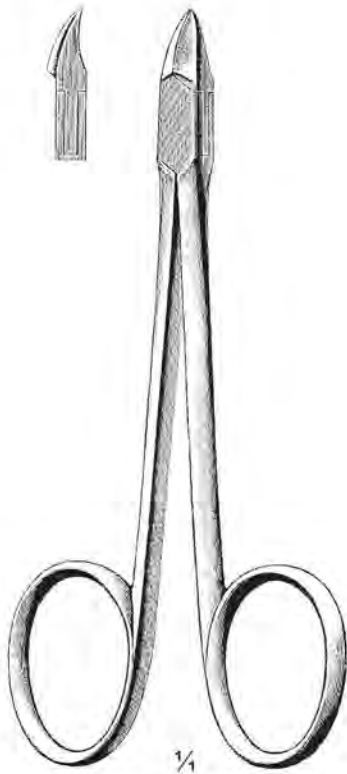

**122-07-10** 10 cm / 4"  
**122-08-13** 13 cm / 5 1/8"



Cohen  
**122-09-13**  
13 cm / 5 1/8"



Cohen  
**122-10-13**  
13 cm / 5 1/8"

**Maniküre, Pediküre ; Manicura, pedicura  
 Manicure, Pedicure ; Manicure, pedicura  
 Manicure, pedicure ; Manicure, pedicure**



123-02-13



123-03-13



123-04-13



123-05-13



123-06-13



123-07-13



123-08-13



1/4

123-01-13  
 123-01-13 To 123-18-13  
 13.5 cm / 5 1/4"



123-09-13



123-10-13



123-11-13



123-12-13



123-13-13



123-14-13



123-15-13



123-16-13



123-17-13



123-18-13



1/2

123-19-11  
 11 cm / 4 1/4"

**Maniküre, Pediküre ; Manicura, pedicura  
 Manicure, Pedicure ; Manicure, pedicura  
 Manicure, pedicure ; Manicure, pedicura**

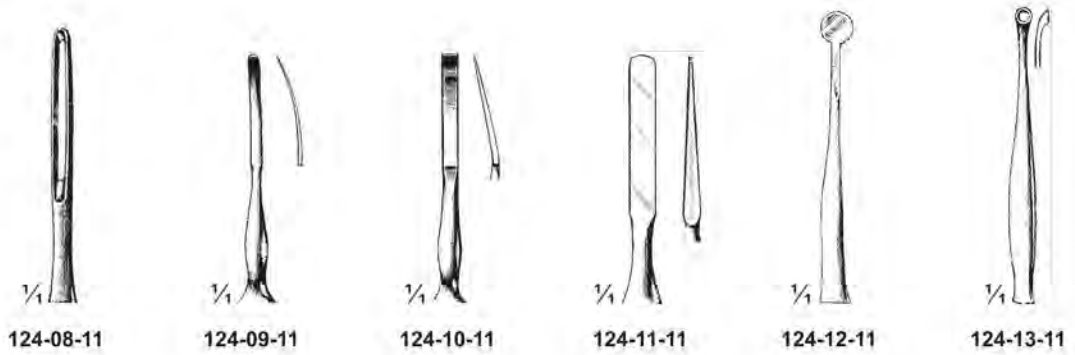
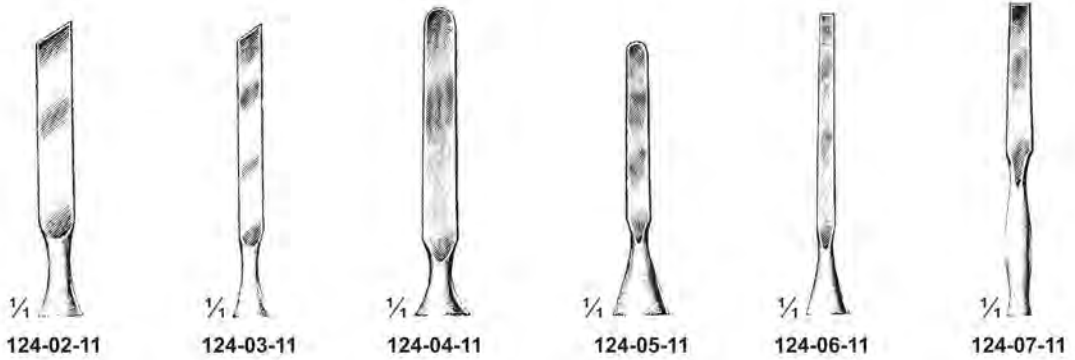

124-01-11  
 124-01-11 To 124-17-11  
 11.5 cm / 4 1/2"



**Maniküre, Pediküre ; Manicura, pedicura  
Manicure, Pedicure ; Manicura, pedicura  
Manicure, pedicure ; Manicura, pedicura**



125-01-14  
14.5 cm / 5 3/4"

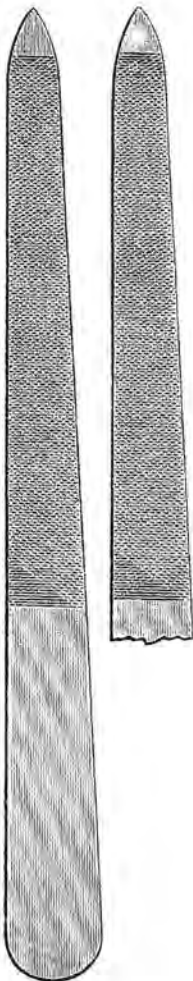

125-06-13  
13 cm / 5 1/8"

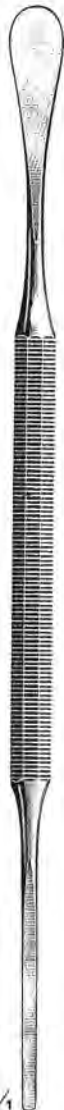

125-02-14  
14.5 cm / 5 3/4"

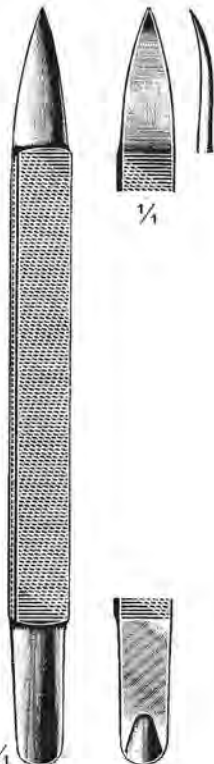

125-07-10 10 cm / 4"  
125-08-11 11.5 cm / 4 1/2"



125-03-13  
13 cm / 5 1/8"



125-04-13  
13 cm / 5 1/8"



125-05-14  
14.5 cm / 5 3/4"



125-09-16  
16 cm / 6 1/4"



**Maniküre, Pediküre ; Manicura, pedicura  
 Manicure, Pedicure ; Manicure, pedicura  
 Manicure, pedicure ; Manicure, pedicura**



**126-01-09** 9 cm / 3½"  
**126-02-10** 10.5 cm / 4¼"

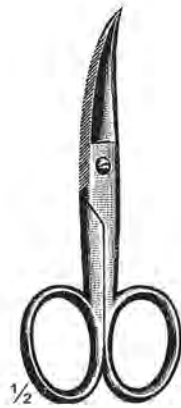

**126-03-09** 9 cm / 3½"  
**126-04-10** 10.5 cm / 4¼"

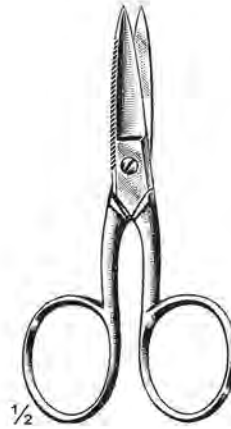

**126-05-09** 9 cm / 3½"  
**126-06-10** 10.5 cm / 4¼"



**126-07-09** 9 cm / 3½"  
**126-08-10** 10.5 cm / 4¼"

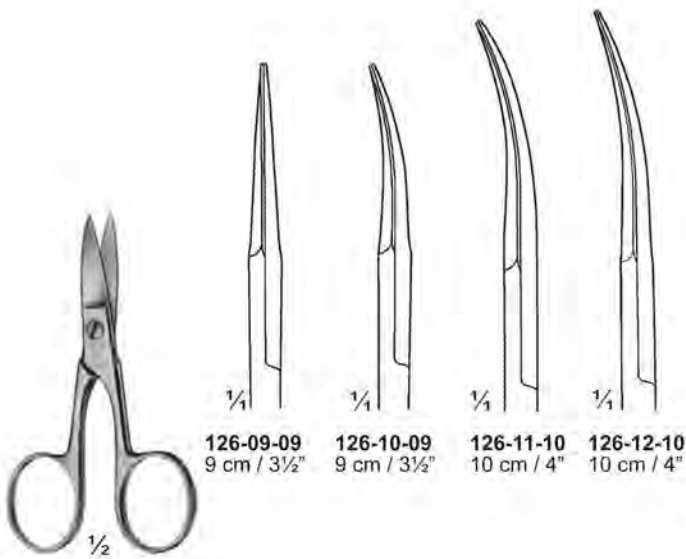

**126-09-09** 9 cm / 3½"  
**126-10-09** 9 cm / 3½"  
**126-11-10** 10 cm / 4"  
**126-12-10** 10 cm / 4"

**126-09-09 To 126-12-10**

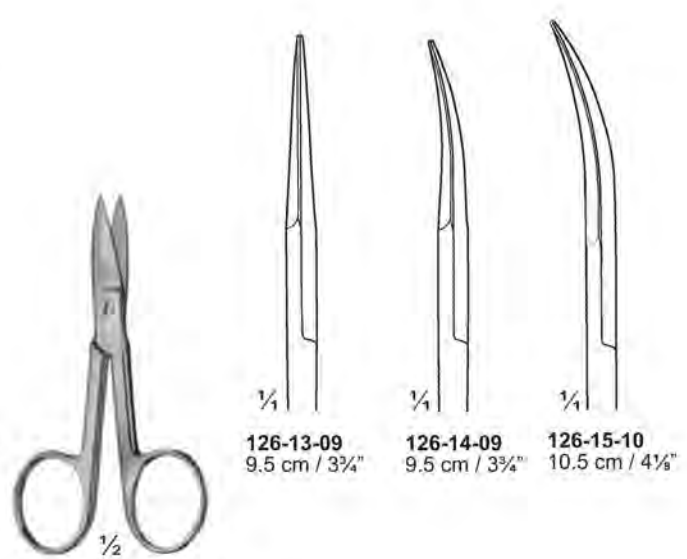

**126-13-09** 9.5 cm / 3¾"  
**126-14-09** 9.5 cm / 3¾"  
**126-15-10** 10.5 cm / 4¼"

**126-13-09 To 126-15-10**

**Maniküre, Pediküre ; Manicura, pedicura  
 Manicure, Pedicure ; Manicure, pedicura  
 Manicure, pedicure ; Manicure, pedicure**



127-01-09 9 cm / 3½"  
 127-02-10 10 cm / 4"

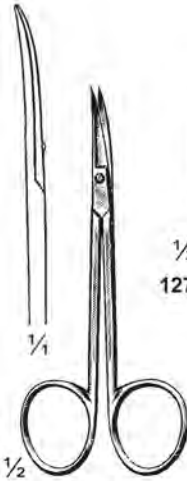

127-03-09 9 cm / 3½" Str  
 127-04-10 10 cm / 4" Str  
 127-05-09 9 cm / 3½" Cur  
 127-06-10 10 cm / 4" Cur

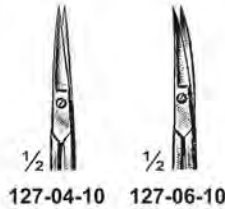

127-07-09 9 cm / 3½" Str  
 127-08-10 10 cm / 4" Str  
 127-09-09 9 cm / 3½" Cur  
 127-10-10 10 cm / 4" Cur



127-11-09 9 cm / 3½" Str  
 127-12-10 10 cm / 4" Str  
 127-13-09 9 cm / 3½" Cur  
 127-14-10 10 cm / 4" Cur



127-15-09 9 cm / 3½" Str  
 127-16-10 10 cm / 4" Str  
 127-17-09 9 cm / 3½" Cur  
 127-18-10 10 cm / 4" Cur



127-19-09 9 cm / 3½" Str  
 127-20-10 10 cm / 4" Str  
 127-21-09 9 cm / 3½" Cur  
 127-22-10 10 cm / 4" Cur



127-23-09 9 cm / 3½" Str  
 127-24-10 10 cm / 4" Str  
 127-25-09 9 cm / 3½" Cur  
 127-26-10 10 cm / 4" Cur



Anatomische & chirurgische Pinzetten ; Pinzes anatómicas & con dientes  
 Dissection & Tissue Forceps ; Pinze anatomica & a denti  
 Pincers à dissection & à griffes ; Pinças anatómicas e cirurgicos



128-01-10  
10 cm / 4"



128-02-12  
12 cm / 4 3/4"



128-03-12  
12.5 cm / 5"



128-04-14  
14 cm / 5 1/2"

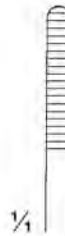

128-05-16  
16 cm / 6 1/4"



128-10-12  
12.5 cm / 5"



128-11-14  
14 cm / 5 1/2"

1/2

1/4

1/4

1/4

1/4

1/2

1/4

Standard  
128-01-10 To 128-09-30  
Broad points

128-06-18  
18 cm / 7"

128-07-20  
20 cm / 8"

128-08-25  
25 cm / 10"

128-09-30  
30 cm / 12"

128-10-12 To 128-12-16  
3 X 4 Teeth

128-12-16  
16 cm / 6 1/4"



128-13-10  
10 cm / 4"



128-14-12  
12 cm / 4 3/4"



128-15-12  
12.5 cm / 5"



128-16-14  
14 cm / 5 1/2"



128-17-16  
16 cm / 6 1/4"



128-22-12  
12.5 cm / 5"



128-23-14  
14 cm / 5 1/2"

1/2

1/4

1/4

1/4

1/4

1/2

1/4

128-13-10 To 128-21-30  
1 X 2 Teeth

128-18-18  
18 cm / 7"

128-19-20  
20 cm / 8"

128-20-25  
25 cm / 10"

128-21-30  
30 cm / 12"

128-22-12 To 128-24-16  
4 X 5 Teeth

128-24-16  
16 cm / 6 1/4"



**Anatomische & chirurgische Pinzetten ; Pinzes anatómicas & con dientes  
Dissection & Tissue Forceps ; Pinze anatomica & a denti  
Pincés à dissection & à griffes ; Pinças anatómicas e cirurgicos**



Standard  
129-01-10 To 129-08-30  
Narrow points

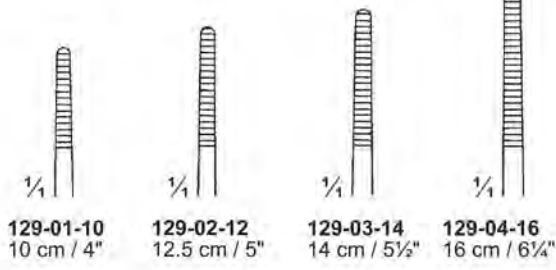

129-01-10 10 cm / 4"  
129-02-12 12.5 cm / 5"  
129-03-14 14 cm / 5½"  
129-04-16 16 cm / 6¼"

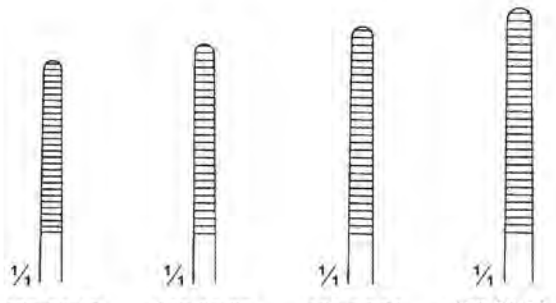

129-05-18 18 cm / 7"  
129-06-20 20 cm / 8"  
129-07-25 25 cm / 10"  
129-08-30 30 cm / 12"

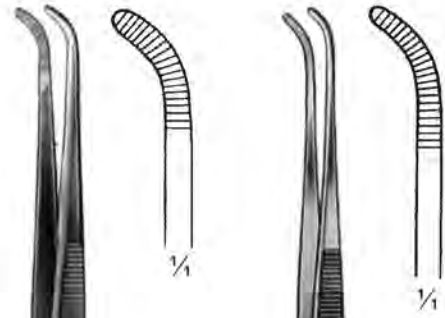

129-09-10 10 cm / 4"  
129-18-10 10 cm / 4"

129-10-11 11.5 cm / 4½"  
129-11-12 12.5 cm / 5"  
129-12-14 14 cm / 5½"  
129-13-16 16 cm / 6¼"  
129-14-18 18 cm / 7"  
129-15-20 20 cm / 8"  
129-16-25 25 cm / 10"  
129-17-30 30 cm / 12"  
129-19-11 11.5 cm / 4½"  
129-20-12 12.5 cm / 5"  
129-21-14 14 cm / 5½"  
129-22-16 16 cm / 6¼"  
129-23-18 18 cm / 7"  
129-24-20 20 cm / 8"  
129-25-25 25 cm / 10"  
129-26-30 30 cm / 12"



129-27-11 To 129-33-25  
2 X 3 Teeth

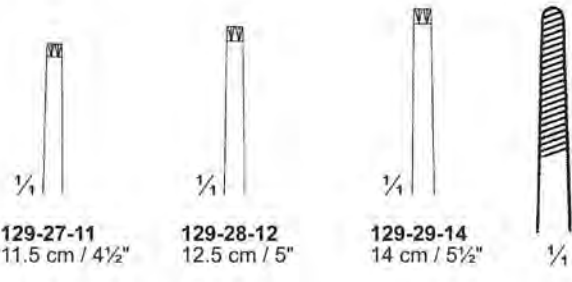

129-27-11 11.5 cm / 4½"  
129-28-12 12.5 cm / 5"  
129-29-14 14 cm / 5½"

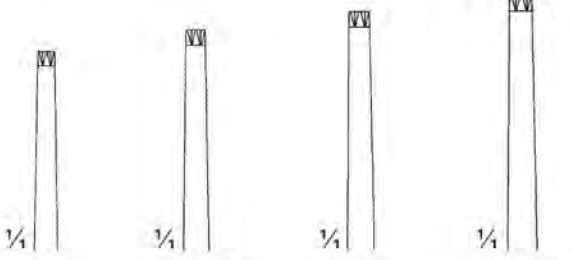

129-30-16 16 cm / 6¼"  
129-31-18 18 cm / 7"  
129-32-20 20 cm / 8"  
129-33-25 25 cm / 10"



129-34-12 12.5 cm / 5"  
129-35-14 14 cm / 5½"  
129-36-16 16 cm / 6¼"

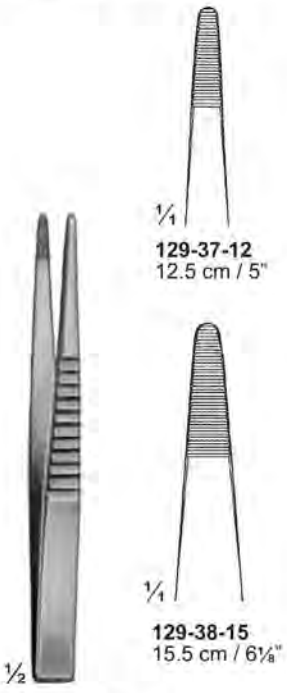

129-37-12 & 129-38-15

129-37-12 12.5 cm / 5"  
129-38-15 15.5 cm / 6¼"

**Anatomische & chirurgische Pinzetten ; Pinzes anatómicas & con dientes**  
**Dissection & Tissue Forceps ; Pinze anatomica & a denti**  
**Pinces à dissection & à griffes ; Pinças anatómicas e cirurgicas**



Standard  
**130-01-11 To 130-08-30**  
 Narrow points

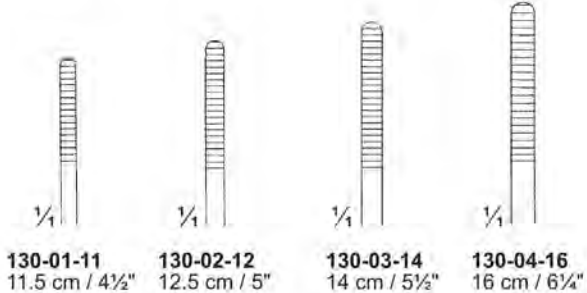

**130-01-11** 11.5 cm / 4½"  
**130-02-12** 12.5 cm / 5"  
**130-03-14** 14 cm / 5½"  
**130-04-16** 16 cm / 6¼"

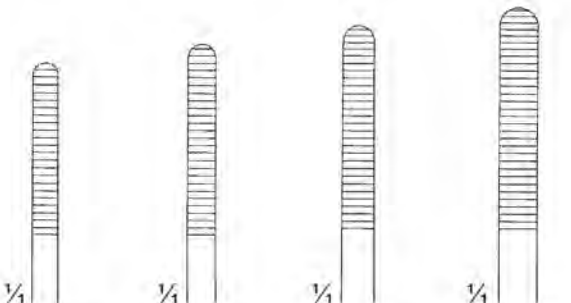

**130-05-18** 18 cm / 7"  
**130-06-20** 20 cm / 8"  
**130-07-25** 25 cm / 10"  
**130-08-30** 30 cm / 12"



Turnover end  
**130-09-12** 12.5 cm / 5"  
**130-10-15** 15 cm / 6"  
**130-11-18** 18 cm / 7"  
**130-12-20** 20 cm / 8"  
**130-13-23** 23 cm / 9"  
**130-14-25** 25 cm / 10"  
**130-15-28** 28 cm / 11"  
**130-16-30** 30 cm / 12"



Fluted rivetted  
**130-17-12** 12.5 cm / 5"  
**130-18-15** 15 cm / 6"  
**130-19-18** 18 cm / 7"  
**130-20-20** 20 cm / 8"  
**130-21-23** 23 cm / 9"  
**130-22-25** 25 cm / 10"  
**130-23-28** 28 cm / 11"  
**130-24-30** 30 cm / 12"



**130-25-11 To 130-56-30**

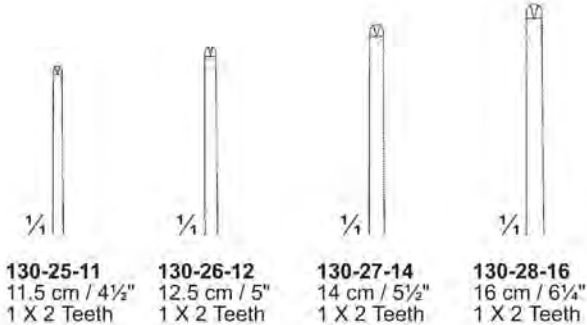

**130-25-11** 11.5 cm / 4½"  
 1 X 2 Teeth  
**130-26-12** 12.5 cm / 5"  
 1 X 2 Teeth  
**130-27-14** 14 cm / 5½"  
 1 X 2 Teeth  
**130-28-16** 16 cm / 6¼"  
 1 X 2 Teeth

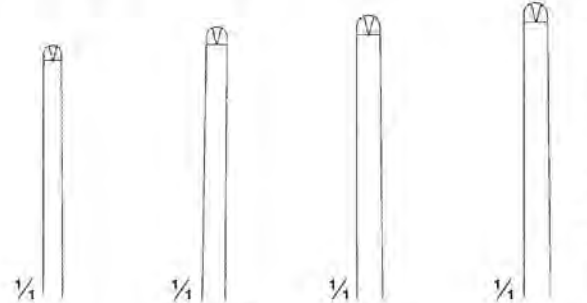

**130-29-18** 18 cm / 7"  
 1 X 2 Teeth  
**130-30-20** 20 cm / 8"  
 1 X 2 Teeth  
**130-31-25** 25 cm / 10"  
 1 X 2 Teeth  
**130-32-30** 30 cm / 12"  
 1 X 2 Teeth

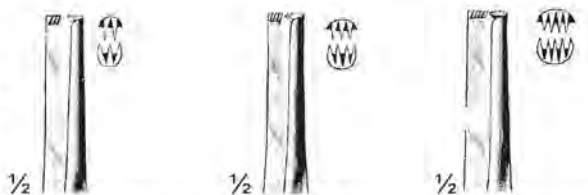

**130-33-12** 12 cm / 4¾"  
 2 X 3 Teeth  
**130-34-12** 12.5 cm / 5"  
**130-35-16** 16 cm / 6¼"  
**130-36-18** 18 cm / 7"  
**130-37-20** 20 cm / 8"  
**130-38-23** 23 cm / 9"  
**130-39-25** 25 cm / 10"  
**130-40-30** 30 cm / 12"  
**130-41-12** 12 cm / 4¾"  
**130-42-12** 12.5 cm / 5"  
**130-43-16** 16 cm / 6¼"  
**130-44-18** 18 cm / 7"  
**130-45-20** 20 cm / 8"  
**130-46-23** 23 cm / 9"  
**130-47-25** 25 cm / 10"  
**130-48-30** 30 cm / 12"  
 3 X 4 Teeth  
**130-49-12** 12 cm / 4¾"  
**130-50-12** 12.5 cm / 5"  
**130-51-16** 16 cm / 6¼"  
**130-52-18** 18 cm / 7"  
**130-53-20** 20 cm / 8"  
**130-54-23** 23 cm / 9"  
**130-55-25** 25 cm / 10"  
**130-56-30** 30 cm / 12"  
 4 X 5 Teeth

**Anatomische & chirurgische Pinzetten ; Pinzes anatómicas & con dientes**  
**Dissection & Tissue Forceps ; Pinze anatomica & a denti**  
**Pinces à dissection & à griffes ; Pinças anatómicas e cirurgicos**

 $\frac{1}{2}$	 $\frac{1}{4}$ <b>131-01-12</b> 12.5 cm / 5"	 $\frac{1}{4}$ <b>131-02-14</b> 14 cm / 5½"	 $\frac{1}{4}$	 $\frac{1}{2}$	 $\frac{1}{4}$	 $\frac{1}{4}$	
<b>131-01-12 To 131-03-16</b>	<b>131-03-16</b> 16 cm / 6¼"	Select <b>131-04-11</b> 11 cm / 4¼" <b>131-05-12</b> 12.5 cm / 5"	Select <b>131-06-15</b> 15 cm / 6" <b>131-07-18</b> 18 cm / 7" <b>131-08-20</b> 20 cm / 8"	Select <b>131-09-11</b> 11 cm / 4¼" <b>131-10-12</b> 12.5 cm / 5" 1 X 2 Teeth	Select <b>131-11-15</b> 15 cm / 6" <b>131-12-18</b> 18 cm / 7" <b>131-13-20</b> 20 cm / 8" 1 X 2 Teeth		
 $\frac{1}{2}$	 $\frac{1}{4}$ <b>131-14-18</b> 1 X 2 Teeth	 $\frac{1}{2}$	 $\frac{1}{2}$ <b>131-16-18</b> 1 X 2 Teeth	 $\frac{1}{2}$	 $\frac{1}{4}$ <b>131-18-18</b> 1 X 2 Teeth	 $\frac{1}{4}$ <b>131-20-13</b> 13 cm / 5¼"	 $\frac{1}{4}$ <b>131-21-15</b> 15 cm / 6"
<b>Ferris-Smith</b> <b>131-14-18 &amp; 131-15-18</b> 18 cm / 7"	<b>Ferris-Smith</b> <b>131-16-18 &amp; 131-17-18</b> 18 cm / 7"	<b>Boney</b> <b>131-18-18 &amp; 131-19-18</b> 18 cm / 7"	<b>131-20-13 To 131-23-20</b> Swedish pattern	<b>131-22-17</b> 17 cm / 6¾"	<b>131-23-20</b> 20 cm / 8"		



132-01-12 & 132-02-14

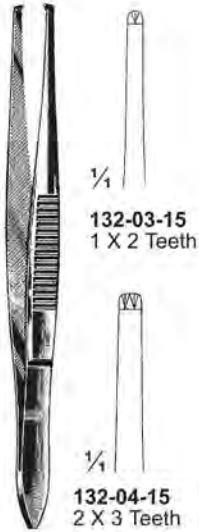

Stille  
 132-03-15 & 132-04-15  
 15 cm / 6"

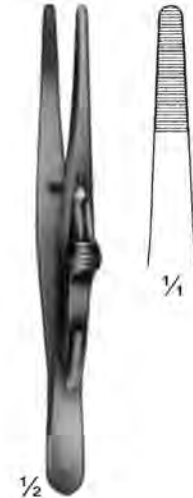

Fricke  
 132-05-13  
 13 cm / 5 1/8"



Ramsay  
 132-06-18  
 18 cm / 7"

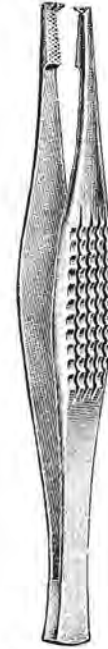

Ramsay  
 132-07-18  
 18 cm / 7"  
 1 X 2 Teeth



Duehrssen  
 132-08-20  
 20 cm / 8"

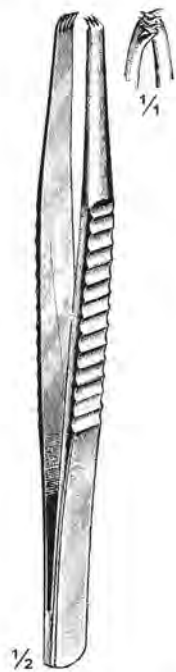

Rooke  
 132-09-12 12.5 cm / 5"  
 132-10-15 15 cm / 6"  
 132-11-18 18 cm / 7"  
 132-12-20 20 cm / 8"  
 3 X 4 Teeth



Stille  
 132-13-12 12.5 cm / 5"  
 132-14-14 14 cm / 5 1/2"  
 132-15-15 15 cm / 6"  
 132-16-18 18 cm / 7"  
 132-17-20 20 cm / 8"



McIndoe  
 132-18-16  
 16 cm / 6 1/4"



Gillies  
 132-19-16  
 16 cm / 6 1/4"  
 1 X 2 Teeth



Ochsner  
 132-20-14 14 cm / 5 1/2"  
 132-21-16 16 cm / 6 1/4"



Strong Model  
 132-22-14  
 14 cm / 5 1/2"

**Anatomische & chirurgische Pinzetten ; Pinzes anatómicas & con dientes  
Dissection & Tissue Forceps ; Pinze anatomica & a denti  
Pincers à dissection & à griffes ; Pinças anatómicas e cirurgicos**

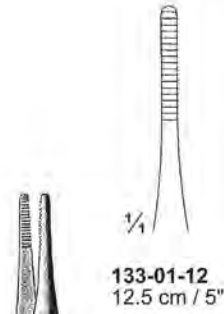

**133-01-12**  
12.5 cm / 5"

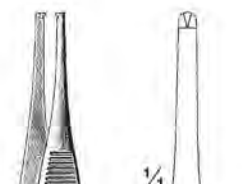

**133-03-12**  
12.5 cm / 5"



**133-05-15**  
15 cm / 6"



**133-06-20**  
20 cm / 8"

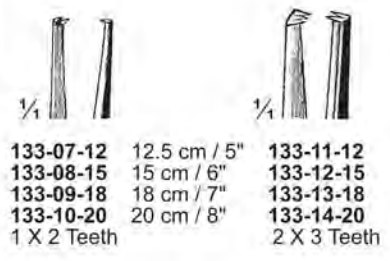

**133-07-12** 12.5 cm / 5"  
**133-08-15** 15 cm / 6"  
**133-09-18** 18 cm / 7"  
**133-10-20** 20 cm / 8"  
1 X 2 Teeth

**133-11-12**  
**133-12-15**  
**133-13-18**  
**133-14-20**  
2 X 3 Teeth



**133-15-12** 12.5 cm / 5"  
**133-16-15** 15 cm / 6"  
**133-17-18** 18 cm / 7"  
**133-18-20** 20 cm / 8"  
3 X 4 Teeth

**133-01-12 & 133-02-14**

**133-03-12 & 133-04-14**  
1 X 2 Teeth

Strassburger Mod.  
**133-05-15 & 133-06-20**  
1 X 2 Teeth

Treaves  
**133-07-12 To 133-18-20**



Semken  
**133-19-12** 12.5 cm / 5"  
**133-20-14** 14 cm / 5½"  
**133-21-15** 15 cm / 6"

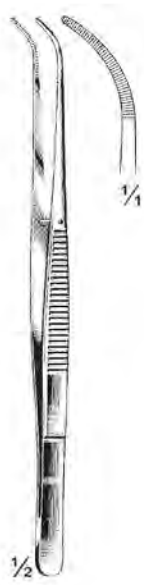

Semken  
**133-22-12** 12.5 cm / 5"  
**133-23-14** 14 cm / 5½"  
**133-24-15** 15 cm / 6"



Semken  
**133-25-12** 12.5 cm / 5"  
**133-26-14** 14 cm / 5½"  
**133-27-15** 15 cm / 6"  
1 X 2 Teeth



Semken  
**133-28-12** 12.5 cm / 5"  
**133-29-14** 14 cm / 5½"  
**133-30-15** 15 cm / 6"  
1 X 2 Teeth



Semken  
**133-31-12** 12.5 cm / 5"  
**133-32-14** 14 cm / 5½"  
2 X 3 Teeth

Anatomische & chirurgische Pinzetten ; Pinzes anatómicas & con dientes  
 Dissection & Tissue Forceps ; Pinze anatomica & a denti  
 Pincers à dissection & à griffes ; Pinças anatómicas e cirurgicos



Waugh  
 134-01-18 18 cm / 7"  
 134-02-20 20 cm / 8"  
 134-03-25 25 cm / 10"  
 134-04-30 30 cm / 12"



Waugh  
 134-05-18 18 cm / 7"  
 134-06-20 20 cm / 8"  
 134-07-25 25 cm / 10"  
 134-08-30 30 cm / 12"  
 1 X 2 Teeth



Waugh  
 134-09-18 To 134-12-30  
 1 X 2 Teeth



1/4  
 134-09-18  
 18 cm / 7"



1/4  
 134-10-20  
 20 cm / 8"



1/4  
 134-11-25  
 25 cm / 10"



1/4  
 134-12-30  
 30 cm / 12"



Stille-Barraya  
 134-13-18 To 134-15-25  
 3 X 4 Teeth



1/4  
 134-13-18  
 18 cm / 7"



1/4  
 134-14-20  
 20 cm / 8"



1/4  
 134-15-25  
 25 cm / 10"



Brophy  
 134-16-20  
 20 cm / 8"



Brophy  
 134-17-20  
 20 cm / 8"



Brophy  
 134-18-20  
 20 cm / 8"  
 1 X 2 Teeth



Brophy  
 134-19-20  
 20 cm / 8"  
 1 X 2 Teeth



Koenig  
 134-20-16  
 16 cm / 6 1/4"  
 9 X 10 Teeth



Wangensteen  
 134-21-23  
 23 cm / 9"

**Anatomische & chirurgische Pinzetten ; Pinzes anatómicas & con dientes  
Dissection & Tissue Forceps ; Pinze anatomica & a denti  
Pinces à dissection & à griffes ; Pinças anatómicas e cirurgicos**

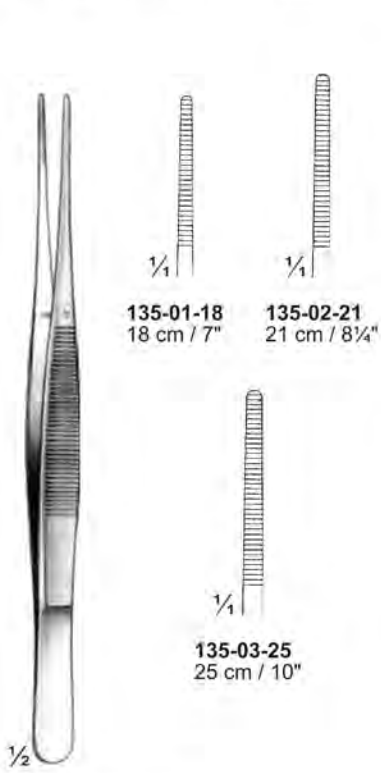

Potts-Smith  
135-01-18 To 135-03-25

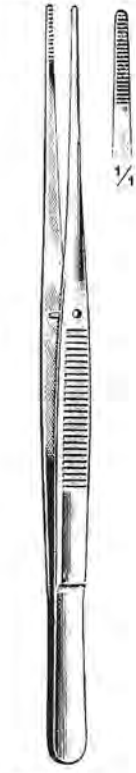

Cushing  
135-04-18  
18 cm / 7"



Cushing  
135-05-18  
18 cm / 7"

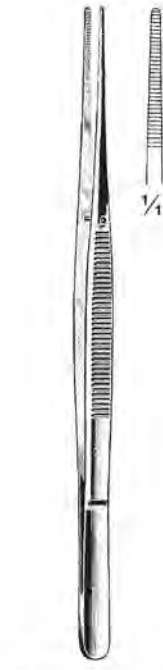

Taylor  
135-06-18 18 cm / 7"  
135-07-20 20 cm / 8"

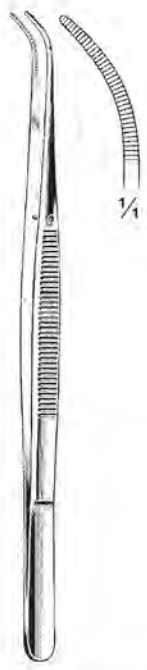

Taylor  
135-08-18 18 cm / 7"  
135-09-20 20 cm / 8"

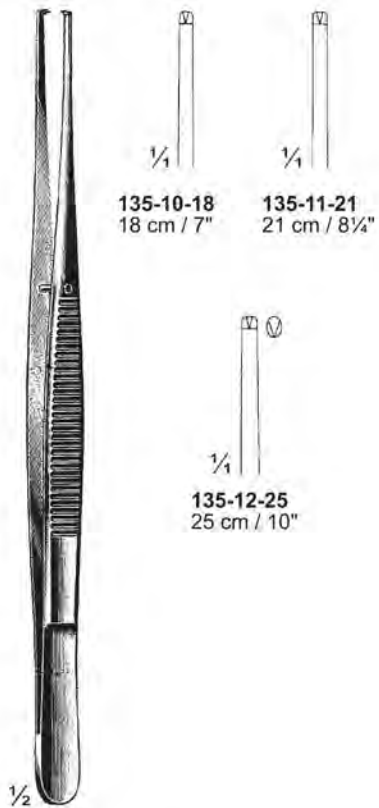

Potts-Smith  
135-10-18 To 135-12-25  
1 X 2 Teeth



Cushing  
135-13-18  
18 cm / 7"



Cushing  
135-14-18  
18 cm / 7"



Cushing  
135-15-18  
18 cm / 7"  
1 X 2 Teeth



Taylor  
135-16-18 18 cm / 7"  
135-17-20 20 cm / 8"





**Anatomische & chirurgische Pinzetten ; Pinzes anatómicas & con dientes  
Dissection & Tissue Forceps ; Pinze anatomica & a denti  
Pincers à dissection & à griffes ; Pinças anatómicas e cirurgicos**

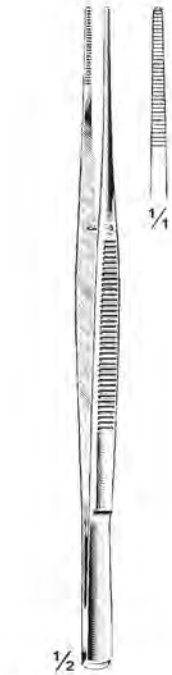

Taylor  
136-01-18 18 cm / 7"  
136-02-20 20 cm / 8"

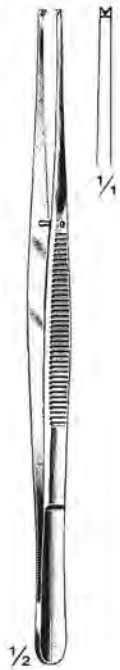

Taylor  
136-03-18  
18 cm / 7"  
1 X 2 Teeth



Taylor  
136-04-18  
18 cm / 7"  
1 X 2 Teeth



Taylor  
136-05-18  
18 cm / 7"  
1 X 2 Teeth

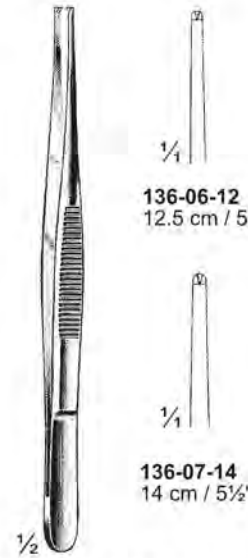

136-06-12 & 136-07-14  
1 X 2 Teeth

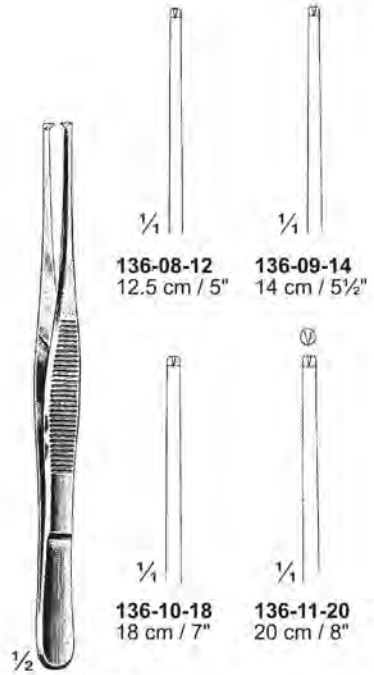

136-08-12 To 136-11-20  
1 X 2 Teeth



Adlerkreutz  
136-12-15 To 136-16-25



136-12-15  
15 cm / 6"  
2 X 3 Teeth

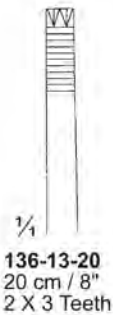

136-13-20  
20 cm / 8"  
2 X 3 Teeth

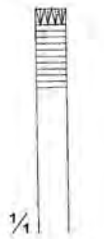

136-14-15  
15 cm / 6"  
4 X 5 Teeth



136-15-20  
20 cm / 8"  
4 X 5 Teeth

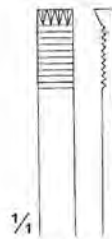

136-16-25  
25 cm / 10"  
4 X 5 Teeth



Skene  
136-17-12 12.5 cm / 5"  
136-18-14 14 cm / 5½"  
136-19-16 16 cm / 6¼"  
136-20-18 18 cm / 7"  
1 X 2 Teeth



Skene  
136-21-12 12.5 cm / 5"  
136-22-14 14 cm / 5½"  
136-23-16 16 cm / 6¼"  
136-24-18 18 cm / 7"  
2 X 3 Teeth



Skene  
136-25-12 12.5 cm / 5"  
136-26-14 14 cm / 5½"  
136-27-16 16 cm / 6¼"  
136-28-18 18 cm / 7"  
3 X 4 Teeth



Skene  
136-29-12 12.5 cm / 5"  
136-30-14 14 cm / 5½"  
136-31-16 16 cm / 6¼"  
136-32-18 18 cm / 7"  
4 X 5 Teeth



**Anatomische & chirurgische Pinzetten ; Pinzes anatómicas & con dientes**  
**Dissection & Tissue Forceps ; Pinze anatomica & a denti**  
**Pinces à dissection & à griffes ; Pinças anatómicas e cirurgicos**

**137-01-15 To 137-03-15**  
15.5 cm / 6 1/8"

**137-01-15**  
0.5 mm

**137-02-15**  
0.8 mm

**137-03-15**  
1.0 mm

**Stone**  
**137-04-15**  
15 cm / 6"  
4 X 5 Teeth

**Stone**  
**137-05-15**  
15 cm / 6"  
5 X 6 Teeth

**Lane**  
**137-06-12 To 137-25-20**

<b>137-06-12</b>	12.5 cm / 5"	<b>137-11-12</b>
<b>137-07-14</b>	14 cm / 5 1/2"	<b>137-12-14</b>
<b>137-08-16</b>	16 cm / 6 1/4"	<b>137-13-16</b>
<b>137-09-18</b>	18 cm / 7"	<b>137-14-18</b>
<b>137-10-20</b>	20 cm / 8"	<b>137-15-20</b>
1 X 2 Teeth		2 X 3 Teeth

<b>137-16-12</b>	12.5 cm / 5"	<b>137-21-12</b>
<b>137-17-14</b>	14 cm / 5 1/2"	<b>137-22-14</b>
<b>137-18-16</b>	16 cm / 6 1/4"	<b>137-23-16</b>
<b>137-19-18</b>	18 cm / 7"	<b>137-24-18</b>
<b>137-20-20</b>	20 cm / 8"	<b>137-25-20</b>
3 X 4 Teeth		4 X 5 Teeth

**137-26-15 To 137-28-15**  
15 cm / 6"  
1 X 2 Teeth

**137-26-15**

**137-27-15**

**137-28-15**

**Lexer**  
**137-29-17**  
17 cm / 6 3/4"  
1 X 2 Teeth

**Gerald**  
**137-30-18**  
18 cm / 7"

**Gerald**  
**137-31-18**  
18 cm / 7"

**Gerald**  
**137-32-18**  
18 cm / 7"  
1 X 2 Teeth

**Gerald**  
**137-33-18**  
18 cm / 7"  
1 X 2 Teeth

**Anatomische & chirurgische Pinzetten ; Pinzes anatómicas & con dientes**  
**Dissection & Tissue Forceps ; Pinze anatomica & a denti**  
**Pinces à dissection & à griffes ; Pinças anatómicas e cirurgicos**



Standard  
 138-01-14 14 cm / 5½"  
 138-02-17 17 cm / 6¾"



Rochester  
 138-03-15 15 cm / 6"  
 138-04-16 16 cm / 6¼"  
 138-05-18 18 cm / 7"



138-06-15  
 15 cm / 6"  
 1 X 2 Teeth



138-07-18  
 Smooth Jaws  
 138-07-18 To 138-10-18  
 18 cm / 7"



138-08-18

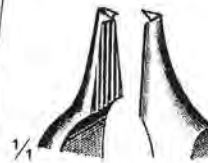

138-09-18  
 1 X 2 Teeth



138-10-18  
 2 X 3 Teeth



Brown  
 138-11-15 15 cm / 6"  
 138-12-20 20 cm / 8"



Duval  
 138-13-14 To 138-16-15



138-13-14 14 cm / 5½"  
 138-14-15 15 cm / 6"



138-15-14 14 cm / 5½"  
 138-16-15 15 cm / 6"



Dührssen  
 138-17-19 To 138-19-19  
 19 cm / 7½"



138-18-19  
 2 X 3 Teeth



138-19-19  
 3 X 4 Teeth



Russ. Model  
 138-20-15 To 138-22-25



138-20-15  
 15 cm / 6"



138-21-20  
 20 cm / 8"



138-22-25  
 25 cm / 10"



Durante  
 138-23-14 To 138-25-20



138-23-14  
 14 cm / 5½"



138-24-16  
 16 cm / 6¼"

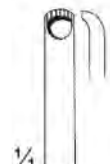

138-25-20  
 20 cm / 8"



Hudson (Ewald)  
 139-01-12  
 12 cm / 4 3/4"



Hudson (Ewald)  
 139-02-12  
 12 cm / 4 3/4"  
 1 X 2 Teeth



Adson  
 139-03-12  
 12 cm / 4 3/4"



Adson  
 139-04-12  
 12 cm / 4 3/4"  
 1 X 2 Teeth



Micro-Adson  
 139-05-12  
 12 cm / 4 3/4"



Micro-Adson  
 139-06-12  
 12 cm / 4 3/4"  
 1 X 2 Teeth



Micro-Adson  
 139-07-15  
 15 cm / 6"



Micro-Adson  
 139-08-15  
 15 cm / 6"  
 1 X 2 Teeth



Adson-Brown  
 139-09-12  
 12 cm / 4 3/4"



Adson-Brown  
 139-10-12  
 12 cm / 4 3/4"

Anatomische & chirurgische Pinzetten ; Pinzes anatómicas & con dientes  
 Dissection & Tissue Forceps ; Pinze anatomica & a denti  
 Pincés à dissection & à griffes ; Pinças anatómicas e cirurgicos



Adson  
140-01-12  
12 cm / 4¾"



Adson  
140-02-12  
12 cm / 4¾"  
1 X 2 Teeth



Adson-Brown  
140-03-12  
12 cm / 4¾"



¼



Adson-Graefe  
140-04-12  
12 cm / 4¾"  
4 X 5 Teeth



¼



Thorpe  
140-05-12  
12 cm / 4¾"



¼



140-06-10 To 140-08-10  
10 cm / 4"



140-06-10



140-07-10



140-08-10



Bonaccolto  
140-09-11  
11 cm / 4¼"



¼



Adson  
140-10-12  
12 cm / 4¾"  
1 X 2 Teeth



¼



Adson  
140-11-12  
12 cm / 4¾"  
1 X 2 Teeth



¼



Adson  
140-12-12  
12 cm / 4¾"  
1 X 2 Teeth



¼



Adson  
140-13-12  
12 cm / 4¾"  
1 X 2 Teeth



¼



Adson  
140-14-15  
15 cm / 6"  
1 X 2 Teeth



¼



Micro-Adson-Biemer  
140-15-12  
12 cm / 4¾"  
1 X 2 Teeth



¼

Anatomische & chirurgische Pinzetten ; Pinzes anatómicas & con dientes  
 Dissection & Tissue Forceps ; Pinze anatomica & a denti  
 Pincès à dissection & à griffes ; Pinças anatómicas e cirurgicos



Collin-Duval  
 141-01-14 To 141-03-27  
 20 cm / 8"



141-01-14  
 14 mm



141-02-18  
 18 mm



141-03-27  
 27 mm



Hepp/Scheidel  
 141-04-18  
 18 cm / 7"



Tubal seizing



141-05-21  
 21 cm / 8 1/4"  
 Catheter seizing



Singley-Tuttle  
 141-06-23 23 cm / 9"  
 141-07-25 25 cm / 10"



Nelson  
 141-08-23 23 cm / 9"  
 141-09-25 25 cm / 10"  
 6 X 7 Teeth

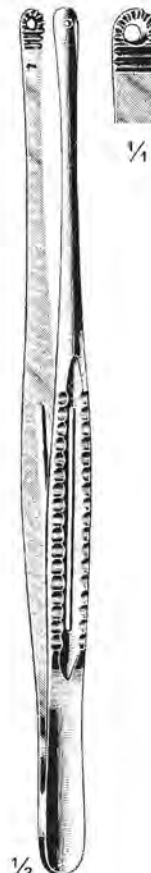

Mayo-Russian  
 141-10-23  
 23 cm / 9"

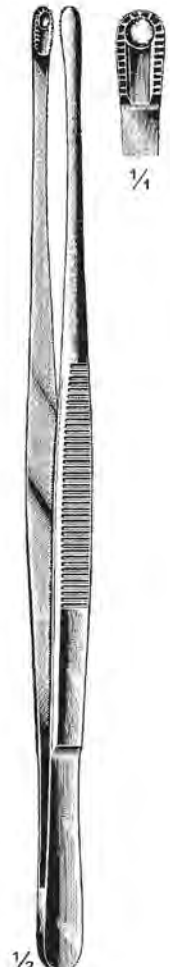

Davis  
 141-11-25  
 25 cm / 10"

Feine anatomische Pinzetten ; Pinzes anatómicas & con dientes  
 Delicate Dissection Forceps ; Pinze delicate per dissezione  
 Pinces délicates à dissection ; Pinças delicadas anatómicas

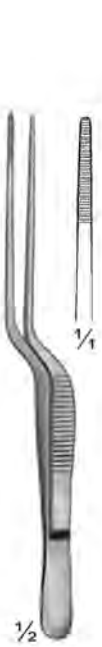

Lucae  
 142-01-14  
 14 cm / 5½"



Lucae  
 142-02-14  
 14 cm / 5½"



Lucae  
 142-03-14  
 14 cm / 5½"  
 1 X 2 Teeth



142-04-16



142-04-16 & 142-05-16  
 16.5 cm / 6½"

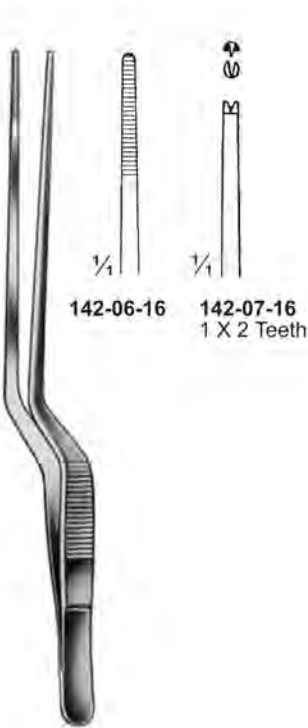

142-06-16 142-07-16  
 1 X 2 Teeth

Gruenwald (Jansen)  
 142-06-16 & 142-07-16  
 16 cm / 6¼"

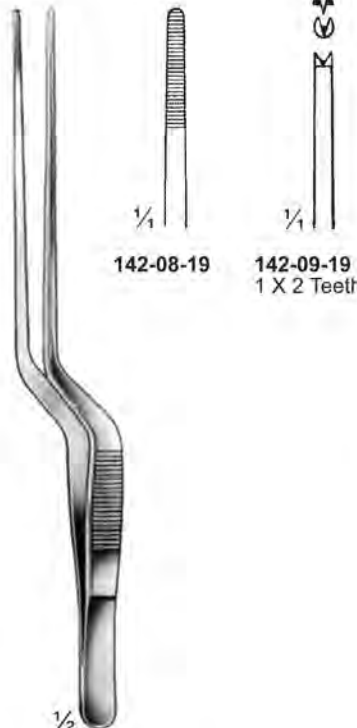

142-08-19 142-09-19  
 1 X 2 Teeth

Gruenwald  
 142-08-19 & 142-09-19  
 19.5 cm / 7¾"



Cottle  
 142-10-14  
 14 cm / 5½"



Gruenwald  
 142-11-18  
 18.5 cm / 7¼"



**Feine anatomische Pinzetten ; Pinzes anatómicas & con dientes  
 Delicate Dissection Forceps ; Pinze delicate per dissezione  
 Pinces délicates à dissection ; Pinças delicadas anatómicas**

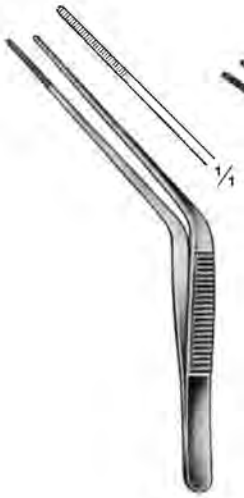

Troeltsch  
(Wilde)  
**143-01-10**  
10 cm / 4"



Wilde  
**143-02-11**  
11.5 cm / 4 1/2"

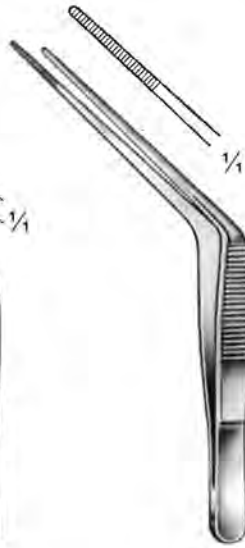

Troeltsch  
(Wilde)  
**143-03-11**  
11 cm / 4 1/4"

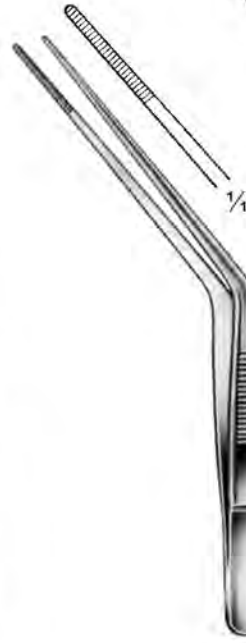

Troeltsch  
(Wilde)  
**143-04-13**  
13 cm / 5"

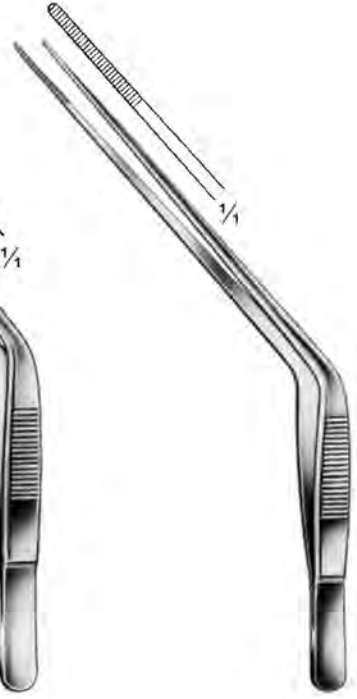

Troeltsch  
**143-05-17**  
17 cm / 6 3/4"



Troeltsch  
(Wilde)  
**143-06-10**  
10 cm / 4"  
1 X 2 Teeth



Troeltsch (Wilde)  
**143-07-11** 11 cm / 4 1/4"  
**143-08-13** 13 cm / 5 1/8"  
1 X 2 Teeth



Troeltsch  
**143-09-13**  
13 cm / 5 1/8"



Troeltsch  
**143-10-14**  
14 cm / 5 1/2"





**Splitterpinzetten ; Pinzas para espinas  
Splinter Forceps ; Pinze per schegge  
Pincès à échardes ; Pinças para lasca**



**144-01-08** 8 cm / 3 1/4"  
**144-02-09** 9 cm / 3 1/2"  
**144-03-10** 10 cm / 4"  
**144-04-11** 11 cm / 4 1/4"  
**144-05-12** 12 cm / 4 3/4"

**144-06-08** 8 cm / 3 1/4"  
**144-07-09** 9 cm / 3 1/2"  
**144-08-10** 10 cm / 4"  
**144-09-11** 11 cm / 4 1/4"  
**144-10-12** 12 cm / 4 3/4"

**144-11-08** 8 cm / 3 1/4"  
**144-12-09** 9 cm / 3 1/2"  
**144-13-10** 10 cm / 4"  
**144-14-11** 11 cm / 4 1/4"  
**144-15-12** 12 cm / 4 3/4"

**144-16-08** 8 cm / 3 1/4"  
**144-17-09** 9 cm / 3 1/2"  
**144-18-10** 10 cm / 4"  
**144-19-11** 11 cm / 4 1/4"  
**144-20-12** 12 cm / 4 3/4"  
1 X 2 Teeth

**144-21-08** 8 cm / 3 1/4"  
**144-22-09** 9 cm / 3 1/2"  
**144-23-10** 10 cm / 4"  
**144-24-11** 11 cm / 4 1/4"  
**144-25-12** 12 cm / 4 3/4"  
1 X 2 Teeth

**144-26-08** 8 cm / 3 1/4"  
**144-27-09** 9 cm / 3 1/2"  
**144-28-10** 10 cm / 4"  
**144-29-11** 11 cm / 4 1/4"  
**144-30-12** 12 cm / 4 3/4"  
1 X 2 Teeth

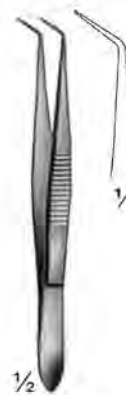

**144-31-08** 8 cm / 3 1/4"  
**144-32-09** 9 cm / 3 1/2"  
**144-33-10** 10.5 cm / 4 1/4"  
**144-34-11** 11.5 cm / 4 1/2"  
**144-35-12** 12.5 cm / 5"  
**144-36-15** 15 cm / 6"

**144-37-08** 8 cm / 3 1/4"  
**144-38-09** 9 cm / 3 1/2"  
**144-39-10** 10.5 cm / 4 1/4"  
**144-40-11** 11.5 cm / 4 1/2"  
**144-41-12** 12.5 cm / 5"  
**144-42-15** 15 cm / 6"

**144-43-08** 8 cm / 3 1/4"  
**144-44-09** 9 cm / 3 1/2"  
**144-45-10** 10.5 cm / 4 1/4"  
**144-46-11** 11.5 cm / 4 1/2"  
**144-47-12** 12.5 cm / 5"  
**144-48-15** 15 cm / 6"

**144-49-08** 8 cm / 3 1/4"  
**144-50-09** 9 cm / 3 1/2"  
**144-51-10** 10.5 cm / 4 1/4"  
**144-52-11** 11.5 cm / 4 1/2"  
**144-53-12** 12.5 cm / 5"  
**144-54-15** 15 cm / 6"

**144-55-10**  
10 cm / 4"

**144-56-10**  
10 cm / 4"

**144-57-10**  
10 cm / 4"

**Splitterpinzetten ; Pinzas para espinas  
Splinter Forceps ; Pinze per schegge  
Pincès à échardes ; Pinças para lasca**

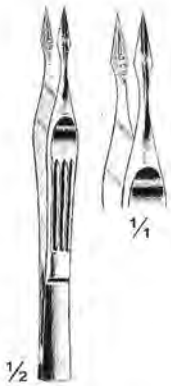

Carmalt  
145-01-10 10 cm / 4"  
145-02-11 11.5 cm / 4½"



Carmalt  
145-03-10 10 cm / 4"  
145-04-11 11.5 cm / 4½"



145-05-11 11 cm / 4¼"  
145-06-12 12 cm / 4¾"  
145-07-12 12.5 cm / 5"



Hunter  
145-08-10 10 cm / 4"  
145-09-11 11 cm / 4¼"



Hunter  
145-10-10 10 cm / 4"  
145-11-11 11 cm / 4¼"



Walter  
145-12-11  
11 cm / 4¼"



Walter  
145-13-11  
11 cm / 4¼"



145-14-10  
10 cm / 4"



145-15-11  
11 cm / 4¼"



145-16-08  
8 cm / 3"

**Splitterpinzetten ; Pinzas para espinas  
Splinter Forceps ; Pinze per schegge  
Pincès à échardes ; Pinças para lasca**



Hunter  
146-01-10 10 cm / 4"  
146-02-11 11.5 cm / 4½"

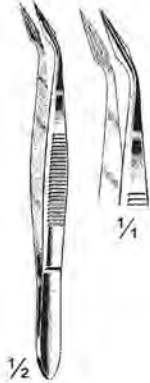

Hunter  
146-03-10 10 cm / 4"  
146-04-11 11.5 cm / 4½"

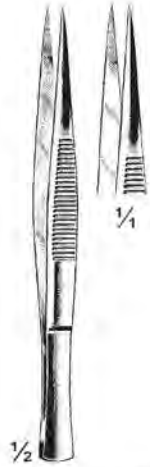

146-05-07 7.5 cm / 3"  
146-06-09 9 cm / 3½"  
146-07-10 10.5 cm / 4¼"  
146-08-11 11.5 cm / 4½"  
146-09-12 12 cm / 4¾"  
146-10-12 12.5 cm / 5"



146-11-08 8 cm / 3⅓"  
146-12-09 9 cm / 3½"  
146-13-10 10.5 cm / 4¼"  
146-14-11 11.5 cm / 4½"



146-15-08 8 cm / 3⅓"  
146-16-09 9 cm / 3½"  
146-17-10 10.5 cm / 4¼"  
146-18-11 11.5 cm / 4½"



146-19-10  
10 cm / 4"



146-20-10  
10 cm / 4"



Schaaf  
146-21-09 9 cm / 3½"  
146-22-10 10 cm / 4"

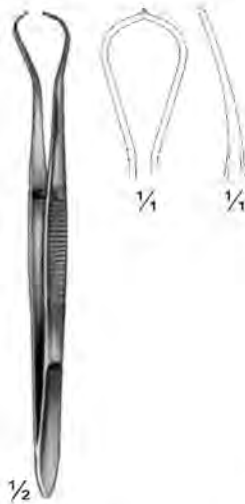

Droeber  
146-23-13  
13 cm / 5¼"



146-24-09 9 cm / 3½"  
146-25-10 10 cm / 4"  
146-26-11 11.5 cm / 4½"



146-27-07 7.5 cm / 3"  
146-28-09 9.5 cm / 3¾"  
146-29-10 10.5 cm / 4¼"  
146-30-11 11.5 cm / 4½"  
146-31-12 12 cm / 4¾"  
146-32-12 12.5 cm / 5"  
146-33-16 16 cm / 6¼"  
146-34-18 18 cm / 7"

**Splitterpinzetten ; Pinzas para espinas  
Splinter Forceps ; Pinze per schegge  
Pincas à échardes ; Pinças para lasca**

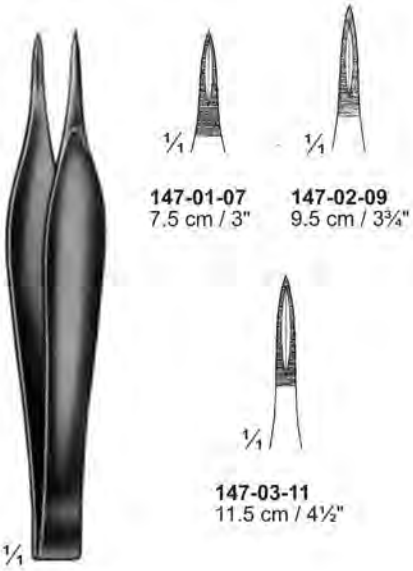

Feilchenfeld  
147-01-07 To 147-03-11

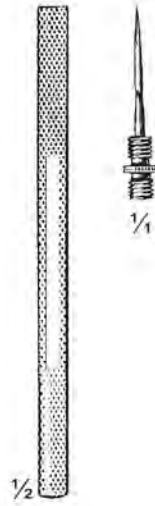

Vanguard  
147-04-13  
Handle size  
13 cm / 5½"

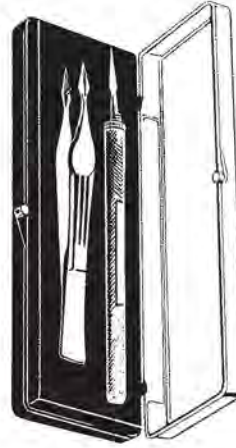

147-05-00  
Splinter removal kit  
Comprising of items  
145-02-09 and 147-04-13

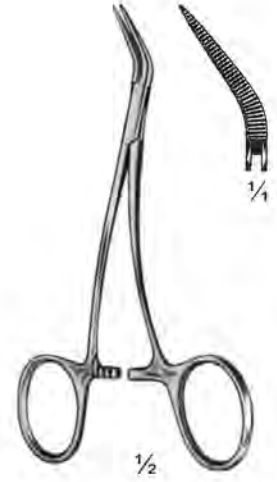

Peel  
147-06-11  
11.5 cm / 4½"



Ralk  
147-07-15  
15 cm / 6"

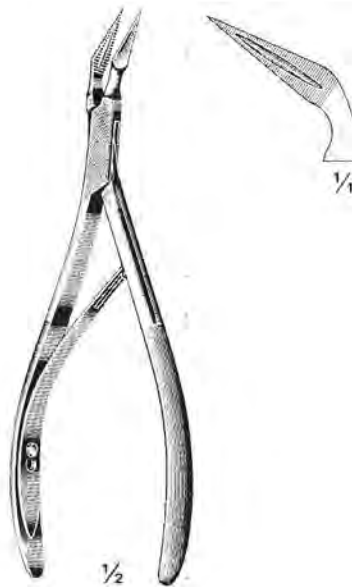

Ralk  
147-08-15  
15 cm / 6"

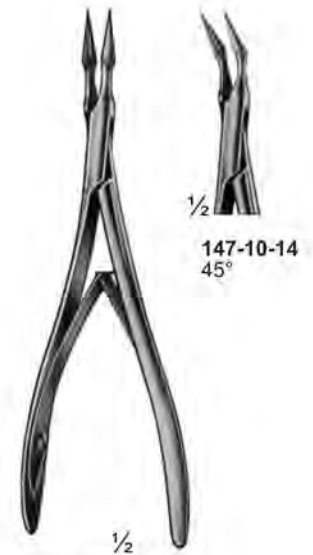

147-09-14  
Ralk (Virtus)  
147-09-14 & 147-10-14  
14 cm / 5½"

**Wimperzangen; Pinzas para erradicar cilios  
Cilia Forceps ; Pinze per spiantare ciglia  
Pincès à épiler les cils ; Pinças para pestana**

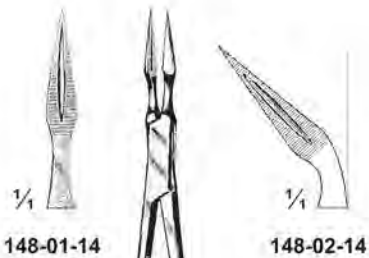

148-01-14

148-02-14



1/2

Stieglitz  
148-01-14 & 148-02-14  
14 cm / 5 1/2"

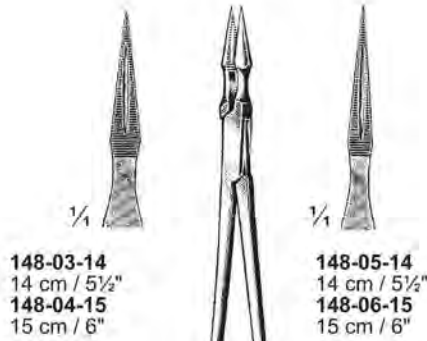

148-03-14  
14 cm / 5 1/2"  
148-04-15  
15 cm / 6"

148-05-14  
14 cm / 5 1/2"  
148-06-15  
15 cm / 6"



1/2

Steiglitz  
148-03-14 To 148-06-15

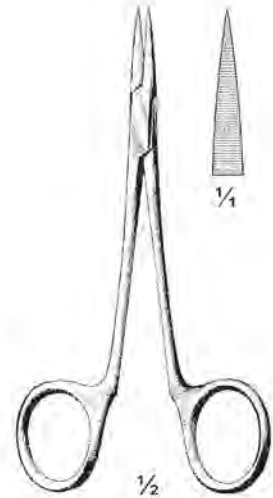

1/4

1/2

Physician  
148-07-13  
13 cm / 5 1/4"

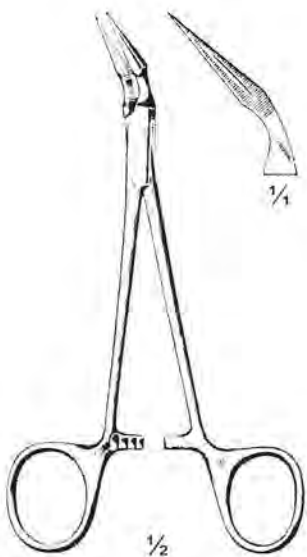

1/4

1/2

Stieglitz  
148-08-14  
14 cm / 5 1/2"

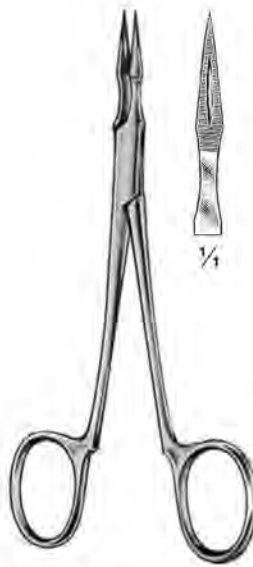

1/4

Arthur  
148-09-14  
14 cm / 5 1/2"

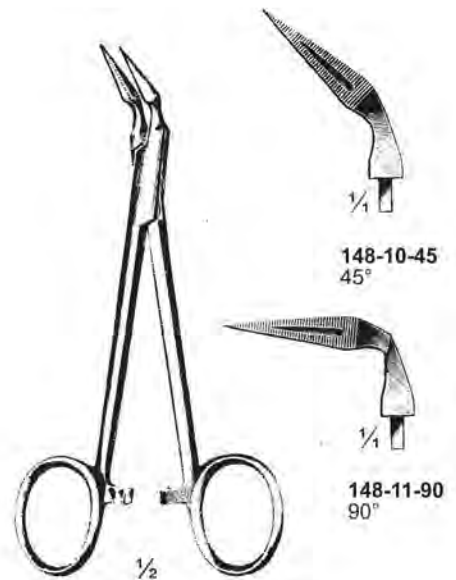

1/4

148-10-45  
45°

1/4

148-11-90  
90°

1/2

Stieglitz (Williams)  
148-10-45 & 148-11-90  
14 cm / 5 1/2"



**Wimperzangen; Pinzas para erradicar cilios  
Cilia Forceps ; Pinze per spiantare ciglia  
Pincès à épiler les cils ; Pinças para pestana**



$\frac{2}{3}$   
Graefe  
149-01  
10.5 cm / 4 $\frac{1}{8}$ "



Ziegler  
149-02  
9 cm / 3 $\frac{1}{2}$ "



$\frac{1}{4}$   
Douglas  
149-03  
7 cm / 2 $\frac{3}{4}$ "

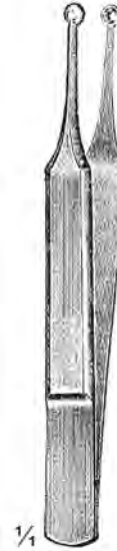

$\frac{1}{4}$   
Bennett  
149-04  
7 cm / 2 $\frac{3}{4}$ "



$\frac{1}{4}$   
149-05 7 cm / 2 $\frac{3}{4}$ "  
149-06 8 cm / 3 $\frac{1}{4}$ "



$\frac{1}{4}$   
Bergh  
149-07-10  
10.5 cm / 4 $\frac{1}{8}$ "



$\frac{1}{4}$   
Bergh  
149-08-08 8 cm / 3 $\frac{1}{4}$ "  
149-09-09 9 cm / 3 $\frac{1}{2}$ "  
149-10-10 10 cm / 4"



$\frac{1}{4}$   
Littauer  
149-11-08 8 cm / 3 $\frac{1}{4}$ "  
149-12-09 9 cm / 3 $\frac{1}{2}$ "  
149-13-10 10 cm / 4"



$\frac{1}{4}$   
Douglas  
149-14-08 8 cm / 3 $\frac{1}{4}$ "  
149-15-09 9 cm / 3 $\frac{1}{2}$ "  
149-16-10 10 cm / 4"



$\frac{1}{2}$   
Saupé  
149-17-10  
10.5 cm / 4 $\frac{1}{8}$ "

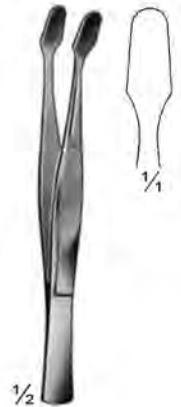

$\frac{1}{2}$   
Kühne  
149-18-10  
10.5 cm / 4 $\frac{1}{8}$ "

**Wimperzangen; Pinzas para erradicar cilios  
Cilia Forceps ; Pinze per spiantare ciglia  
Pincès à épiler les cils ; Pinças para pestana**

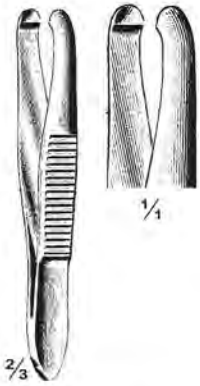

Beer  
150-01-06 6 cm / 2¼"  
150-02-08 8 cm / 3¼"

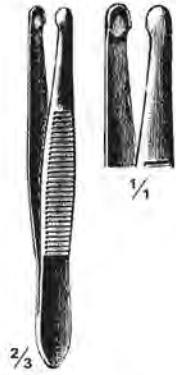

Beer  
150-03-08  
8 cm / 3¼"

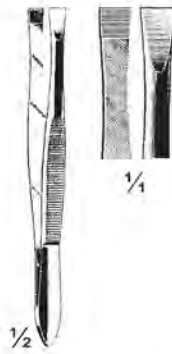

Gouglas  
150-04-09  
9 cm / 3½"



Henry  
150-05-12  
12 cm / 4¾"



Gradle  
150-06-10  
10 cm / 4"



Beaupre  
150-07-12  
12 cm / 4¾"



Automatic  
150-08-10  
10 cm / 4"



150-09-11  
11.5 cm / 4½"



Phillips  
150-10-09  
9 cm / 3½"



Jameson-Evans  
150-11-11  
11 cm / 4¼"

**Spezielle Zange ; Pinzes especiales  
Special Forceps ; Pinze speciale  
Pinces specials ; Pinças especiais**



1/2  
Hunt  
151-01-20  
20 cm / 8"  
Tumor and  
vessel forceps



1/2  
Hunt  
151-02-20  
20 cm / 8"  
Tumor and  
vessel forceps



1/2  
Heifetz  
151-03-03 & 151-04-05  
22 cm / 8 3/4"  
Tumor and  
vessel forceps

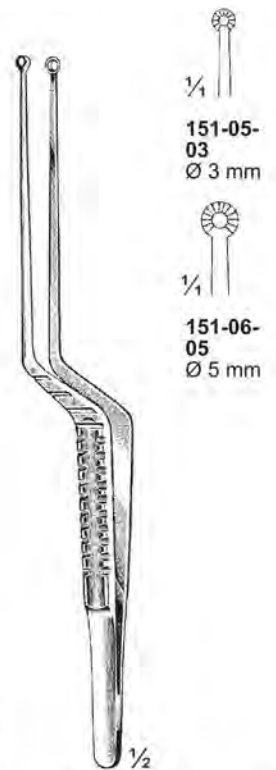

1/2  
Yasargil  
151-05-03 & 151-06-05  
20 cm / 8"  
Tumor and  
vessel forceps



1/2  
Yasargil  
151-07-03 & 151-08-05  
20 cm / 8"  
Spoon type sharp



1/2  
Yasargil  
151-09-03 & 151-10-05  
22 cm / 8 3/4"  
Tumor forceps



1/2  
Yasargil-Samii  
151-11-03 To 151-13-07  
24 cm / 9 1/2"  
Tumor forceps  
Spoon type sharp





**Spezielle Zange ; Pinzes especiales  
Special Forceps ; Pinze speciale  
Pinces specials ; Pinças especiais**



Samii  
152-01-03 To 152-06-05  
23 cm / 9"  
Tumor forceps  
Spoon type sharp

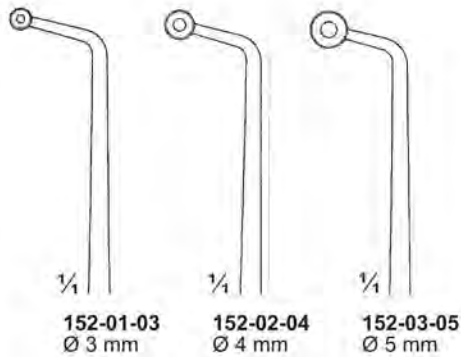

152-01-03 Ø 3 mm    152-02-04 Ø 4 mm    152-03-05 Ø 5 mm

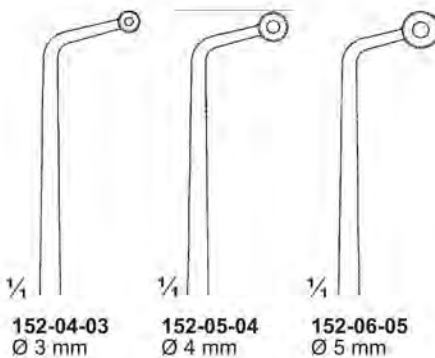

152-04-03 Ø 3 mm    152-05-04 Ø 4 mm    152-06-05 Ø 5 mm



Adson  
152-23-21  
21.5 cm / 8½"  
Hypophyseal forceps



Adson  
152-24-21  
21.5 cm / 8½"  
Hypophyseal forceps



De Bakey  
152-07-15 To 152-22-24



152-07-15 15 cm / 6"    152-11-15  
152-08-18 18 cm / 7"    152-12-18  
152-09-21 21 cm / 8¼"    152-13-21  
152-10-24 24 cm / 9½"    152-14-24  
1 mm    1 mm



152-15-15 15 cm / 6"    152-19-15  
152-16-18 18 cm / 7"    152-20-18  
152-17-21 21 cm / 8¼"    152-21-21  
152-18-24 24 cm / 9½"    152-22-24  
1.8 mm    1.8 mm



152-25-15 152-31-15 15 cm / 6"    152-37-15 152-43-15  
152-26-18 152-32-18 18 cm / 7"    152-38-18 152-44-18  
152-27-20 152-33-20 20 cm / 8"    152-39-20 152-45-20  
Jaw 0.4 X 6 mm    Jaw 0.4 X 6 mm  
1 X 2 Teeth    1 X 2 Teeth

152-28-15 152-34-15 15 cm / 6"    152-40-15 152-46-15  
152-29-18 152-35-18 18 cm / 7"    152-41-18 152-47-18  
152-30-20 152-36-20 20 cm / 8"    152-42-20 152-48-20  
Jaw 0.8 X 6 mm    Jaw 0.8 X 6 mm  
1 X 2 Teeth    1 X 2 Teeth



152-49-15 15 cm / 6" 0.4 mm    152-55-15  
152-50-15 15 cm / 6" 0.8 mm    152-56-15  
152-51-18 18 cm / 7" 0.4 mm    152-57-18  
152-52-18 18 cm / 7" 0.8 mm    152-58-18  
152-53-20 20 cm / 8" 0.4 mm    152-59-20  
152-54-20 20 cm / 8" 0.8 mm    152-60-20

**Spezielle Zange ; Pinzes especiales  
Special Forceps ; Pinze speciale  
Pincers specials ; Pinças especiais**



- $\frac{1}{4}$  153-01-06  
0.6 mm
- $\frac{1}{4}$  153-02-09  
0.9 mm
- $\frac{1}{4}$  153-03-01  
1 X 2 Teeth



- $\frac{1}{4}$  153-04-06  
20 cm / 8"  
0.6 mm
- $\frac{1}{4}$  153-05-09  
20 cm / 8"  
0.9 mm
- $\frac{1}{4}$  153-06-06  
22 cm / 8 $\frac{3}{4}$ "  
0.6 mm
- $\frac{1}{4}$  153-07-09  
22 cm / 8 $\frac{3}{4}$ "  
0.9 mm

Yasargil  
153-06-03 To 153-03-01  
18 cm / 7"

Yasargil  
153-04-06 To 153-07-09

- $\frac{1}{4}$  153-08-06  
0.6 mm
- $\frac{1}{4}$  153-09-09  
0.9 mm



Yasargil  
153-08-06- & 153-09-09  
24 cm / 9 $\frac{1}{2}$ "



- $\frac{1}{4}$  Ring Ø 0.5 X 1.0 mm 153-10-15 15 cm / 6"
- $\frac{1}{4}$  Ring Ø 0.5 X 1.0 mm 153-11-18 18 cm / 7"
- $\frac{1}{4}$  Ring Ø 0.5 X 1.0 mm 153-12-21 21 cm / 8 $\frac{1}{4}$ "
- $\frac{1}{4}$  Ring Ø 0.5 X 1.0 mm 153-13-24 24 cm / 9 $\frac{1}{2}$ "
- 153-14-15
- 153-15-18
- 153-16-21
- 153-17-24

- $\frac{1}{4}$  Ring Ø 1.5 X 2.0 mm 153-18-15 15 cm / 6"
- $\frac{1}{4}$  Ring Ø 1.5 X 2.0 mm 153-19-18 18 cm / 7"
- $\frac{1}{4}$  Ring Ø 1.5 X 2.0 mm 153-20-21 21 cm / 8 $\frac{1}{4}$ "
- $\frac{1}{4}$  Ring Ø 1.5 X 2.0 mm 153-21-24 24 cm / 9 $\frac{1}{2}$ "
- 153-22-15
- 153-23-18
- 153-24-21
- 153-25-24

153-10-15 To 153-25-24



**Anatomische Mikropinzetten ; Pinzes micro de disección  
 Micro Dissection Forceps ; Pinze per micro dissezione  
 Micro-Pinças à dis s eccion ; Micro Pinças de disseccão**



Gerald  
**154-01-18**  
 18 cm / 7"



Gerald  
**154-02-18**  
 18 cm / 7"  
 1 X 2 Teeth



**154-03-18 To 154-05-18**  
 18.5 cm / 7 1/4"

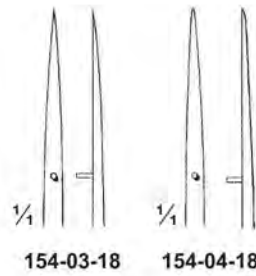

Item No. 154-08-12 To 154-12-16  
 also available in 18/8 stainless



**154-06-22 & 154-07-22**  
 22 cm / 8 3/4"

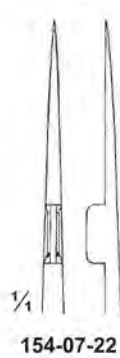

**154-08-12**  
 12.5 cm / 5"



**154-09-12**  
 12.5 cm / 5"



**154-10-12**  
 12.5 cm / 5"



Gomel  
**154-11-16**  
 16 cm / 6 1/4"



Gomel  
**154-12-16**  
 16 cm / 6 1/4"  
 1 X 2 Teeth

**Anatomische Mikropinzetten ; Pinzes micro de disección  
 Micro Dissection Forceps ; Pinze per micro dissezione  
 Micro-Pinçes à dissection ; Micro Pinças de disseccão**

Also available in 18/8 stainless



155-01-10  
10 cm / 4"



155-02-10  
10 cm / 4"



155-03-10  
10 cm / 4"



155-04-14  
14 cm / 5½"



155-05-14  
14 cm / 5½"



155-06-10  
10.5 cm / 4¼"



155-07-10  
10.5 cm / 4¼"



155-08-11  
11.5 cm / 4½"



155-09-11  
11.5 cm / 4½"



155-10-10  
10.5 cm / 4¼"



155-11-10  
10.5 cm / 4¼"



155-12-10  
10.5 cm / 4¼"

**Anatomische Mikropinzetten ; Pinzes micro de disección  
Micro Dissection Forceps ; Pinze per micro dissezione  
Micro-Pinças à dis s ection ; Micro Pinças de disseccão**



Jacobson-Adson  
**156-01-12**  
12 cm / 4¾"



Jacobson-Adson  
**156-02-15**  
15 cm / 6"

Item No. 156-03-14 To 156-14-18  
also available in 18/8 stainless



**156-03-12 & 156-04-12**  
12 cm / 4¾"



**156-05-12 & 156-06-12**  
12 cm / 4¾"



**156-07-15 To 156-10-18**



**156-11-15 To 156-14-18**

**156-07-15**  
15 cm / 6"  
**156-08-18**  
18 cm / 7"

**156-11-15**  
15 cm / 6"  
**156-12-18**  
18 cm / 7"

**156-09-15**  
15 cm / 6"  
**156-10-18**  
18 cm / 7"

**156-13-15**  
15 cm / 6"  
**156-14-18**  
18 cm / 7"

**Anatomische Mikropinzetten ; Pinzes micro de disección  
 Micro Dissection Forceps ; Pinze per micro dissezione  
 Micro-Pinças à dis s ection ; Micro Pinças de disseccão**

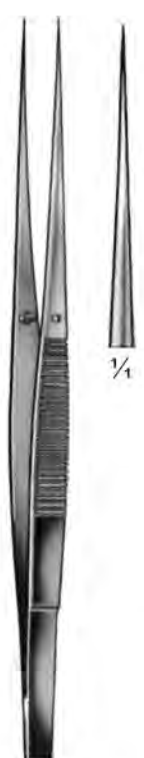

Jacobson  
 157-01-11 11 cm / 4 1/4"  
 157-02-15 15 cm / 6"  
 157-03-18 18 cm / 7"

157-04-19  
 19.5 cm / 7 3/4"

157-05-19  
 19.5 cm / 7 3/4"

157-06-19  
 19.5 cm / 7 3/4"

157-07-19  
 19.5 cm / 7 3/4"

157-08-19  
 19.5 cm / 7 3/4"

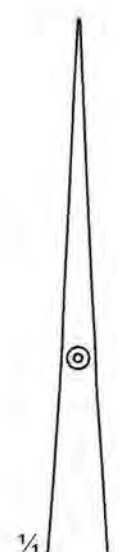
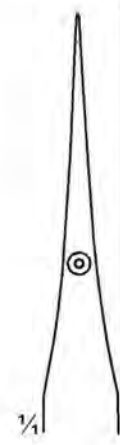

157-09-19  
 19 cm / 7 1/2"

Yasargil  
 157-10-18  
 18.5 cm / 7 1/4"

Brock  
 157-11-15  
 15 cm / 6"

Brock  
 157-12-18  
 18 cm / 7"

**Pinzetten mit Hartmetall-Einsätzen ; Pinzas de carburo de tungsteno  
Tungsten Carbide Forceps ; Pinze di carburo di tungsteno  
Pincas en carbure de tungsten ; Pinças de carboneto de tungstênio**



Adson-Brown  
158-01-12  
12 cm / 4 3/4"



Adson-Brown  
158-02-12  
12 cm / 4 3/4"



Adson  
158-03-15 To 158-07-12  
1 X 2 Teeth

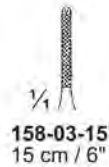

158-03-15  
15 cm / 6"

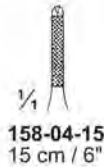

158-04-15  
15 cm / 6"

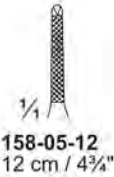

158-05-12  
12 cm / 4 3/4"

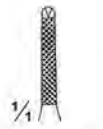

158-06-12  
12 cm / 4 3/4"



158-07-12  
12 cm / 4 3/4"

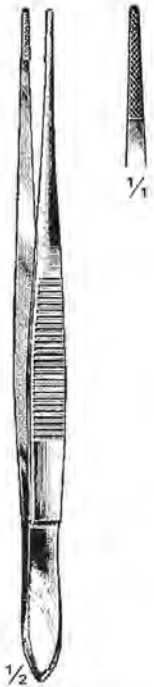

Cushing  
158-08-18  
18 cm / 7"



Adson  
158-09-12 To 158-12-15

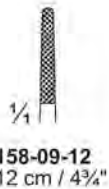

158-09-12  
12 cm / 4 3/4"



158-10-12  
12 cm / 4 3/4"

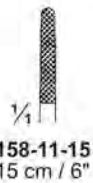

158-11-15  
15 cm / 6"



158-12-15  
15 cm / 6"



Standard  
158-13-12 12 cm / 4 3/4"  
158-14-14 14 cm / 5 1/2"  
158-15-16 16 cm / 6 1/4"  
158-16-18 18 cm / 7"  
158-17-20 20 cm / 8"  
158-18-25 25 cm / 10"



Oehler  
158-19-14 To 158-24-30  
1 X 2 Teeth



158-19-14  
14 cm / 5 1/2"

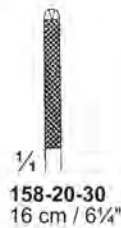

158-20-30  
16 cm / 6 1/4"

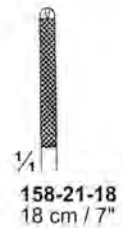

158-21-18  
18 cm / 7"

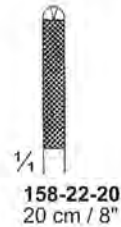

158-22-20  
20 cm / 8"



158-23-25  
25 cm / 10"

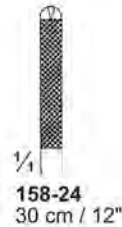

158-24  
30 cm / 12"

Pinzetten mit Hartmetall-Einsätzen ; Pinzas de carburo de tungsteno  
 Tungsten Carbide Forceps ; Pinze di carburo di tungsteno  
 Pincas en carbure de tungsten ; Pinças de carboneto de tungstênio

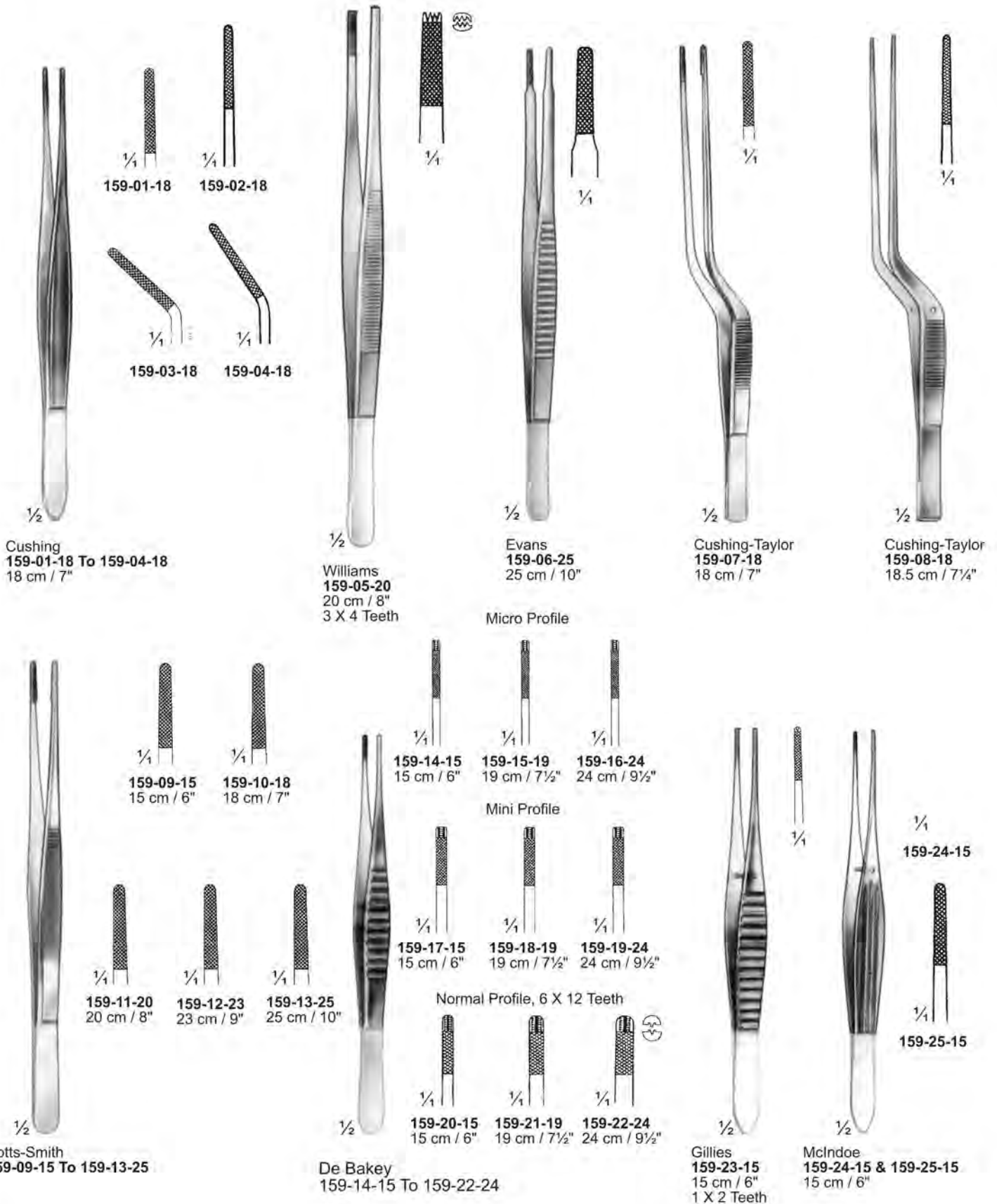

**Cushing**  
 159-01-18 To 159-04-18  
 18 cm / 7"

**Williams**  
 159-05-20  
 20 cm / 8"  
 3 X 4 Teeth

**Evans**  
 159-06-25  
 25 cm / 10"

**Cushing-Taylor**  
 159-07-18  
 18 cm / 7"

**Cushing-Taylor**  
 159-08-18  
 18.5 cm / 7 1/4"

**Potts-Smith**  
 159-09-15 To 159-13-25

**De Bakey**  
 159-14-15 To 159-22-24

**Gillies**  
 159-23-15  
 15 cm / 6"  
 1 X 2 Teeth

**McIndoe**  
 159-24-15 & 159-25-15  
 15 cm / 6"

**Micro Profile**

**Mini Profile**

**Normal Profile, 6 X 12 Teeth**

159-01-18 1/4  
 159-02-18 1/4  
 159-03-18 1/4  
 159-04-18 1/4

159-09-15 1/4  
 159-10-18 1/4  
 159-11-20 1/4  
 159-12-23 1/4  
 159-13-25 1/4

159-14-15 1/4  
 159-15-19 1/4  
 159-16-24 1/4  
 159-17-15 1/4  
 159-18-19 1/4  
 159-19-24 1/4  
 159-20-15 1/4  
 159-21-19 1/4  
 159-22-24 1/4

159-24-15 1/4  
 159-25-15 1/4

15 cm / 6"  
 18 cm / 7"  
 15 cm / 6"  
 19 cm / 7 1/2"  
 24 cm / 9 1/2"  
 15 cm / 6"  
 19 cm / 7 1/2"  
 24 cm / 9 1/2"  
 15 cm / 6"  
 19 cm / 7 1/2"  
 24 cm / 9 1/2"



**Pinzetten mit Hartmetall-Einsätzen ; Pinzas de carburo de tungsteno  
Tungsten Carbide Forceps ; Pinze di carburo di tungsteno  
Pincas en carbure de tungsten ; Pinças de carboneto de tungstênio**



Gruenwald  
160-01-18  
18.5 cm / 7 1/4"



160-02-14 To 160-04-23

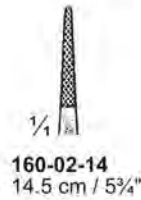

160-02-14  
14.5 cm / 5 3/4"

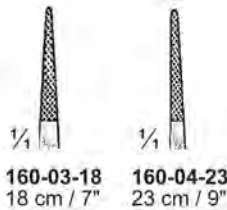

160-03-18 18 cm / 7"  
160-04-23 23 cm / 9"



Ferris - Smith  
160-05-17  
17 cm / 6 3/4"  
1 X 2 Teeth



Semken  
160-06-16 To 160-09-18  
1 X 2 Teeth

Normal Profile

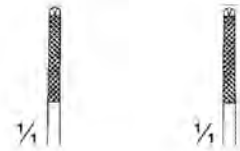

160-06-16 16 cm / 6 1/4"  
160-07-18 18 cm / 7"

Mini Profile

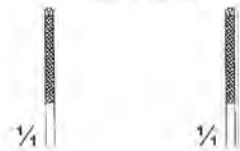

160-08-16 16 cm / 6 1/4"  
160-09-18 18 cm / 7"



Gerald  
160-10-17 & 160-11-17  
17 cm / 6 3/4"



Bonney  
160-12-17 & 160-13-17  
17 cm / 6 3/4"



Skinner  
160-14-23 To 160-16-23  
23 cm / 9"  
1 X 2 Teeth

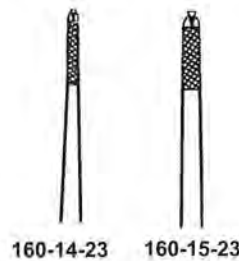

160-14-23 160-15-23



160-16-23



Semken  
160-17-15  
15 cm / 6"



Wangensteen  
160-18-15 To 160-20-25



160-18-15  
15 cm / 6"

160-19-23  
23 cm / 9"

160-20-25  
25 cm / 10"

**Arterienklemmen ; Pinzas hemostáticas  
Haemostatic Forceps ; Pinze emostatica  
Pincas hémostatiques ; Pinça hemostatica**

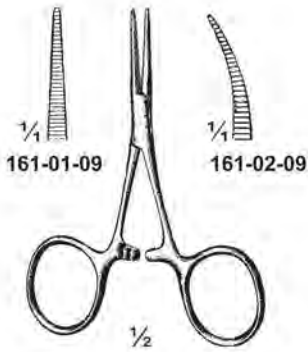

Micro-Hartmann  
**161-01-09 & 161-02-09**  
9 cm / 3 1/2"

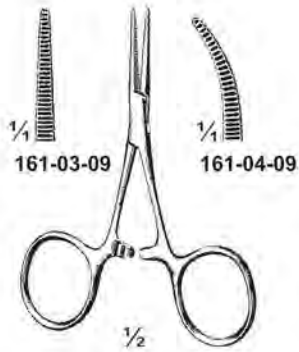

Hartmann  
(Baby Mosquito)  
**161-03-09 & 161-04-09**  
9 cm / 3 1/2"

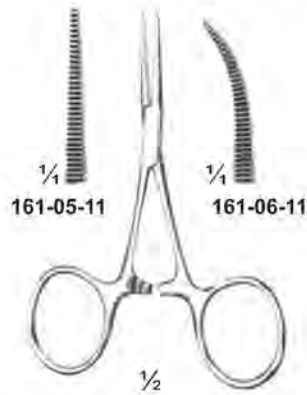

Carrel (Reynolds)  
**161-05-11 & 161-06-11**  
11 cm / 4 1/4"

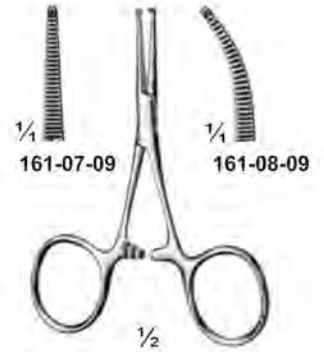

Hartmann  
(Baby-Mosquito)  
**161-07-09 & 161-08-09**  
9 cm / 3 1/2"  
1 X 2 Teeth

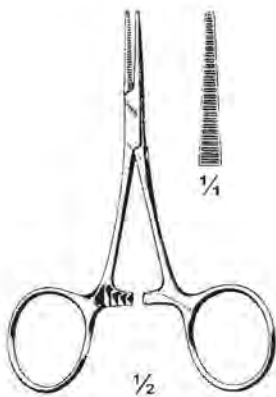

Hartmann  
**161-09-10**  
10 cm / 4"

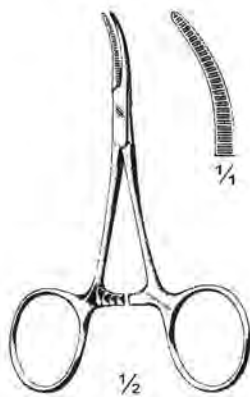

Hartmann  
**161-10-10**  
10 cm / 4"



Hartmann  
**161-11-10**  
10 cm / 4"  
1 X 2 Teeth



Hartmann  
**161-12-10**  
10 cm / 4"  
1 X 2 Teeth

**Arterienklemmen ; Pinzas hemostáticas  
Haemostatic Forceps ; Pinze emostatica  
Pincès hémostatiques ; Pinça hemostatica**

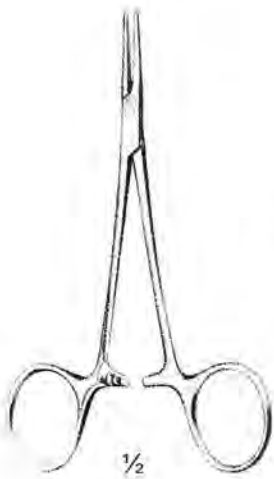

Halstead-Mosquito  
162-01-12 To 162-08-14

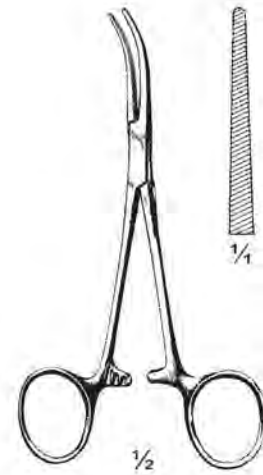
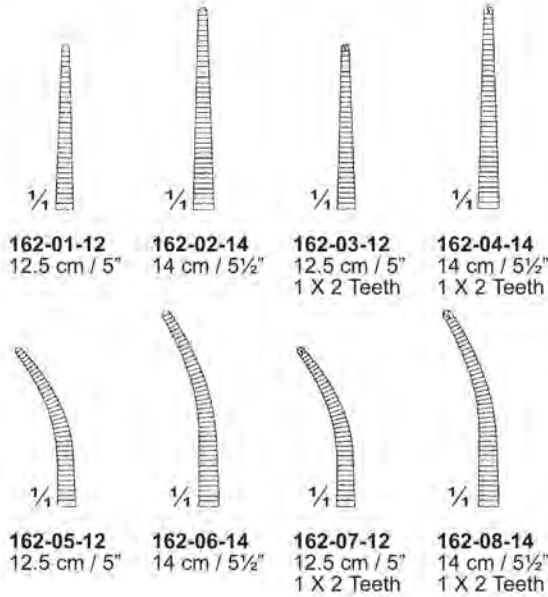

Mosquito-Dandy  
162-09-12  
12.5 cm / 5"

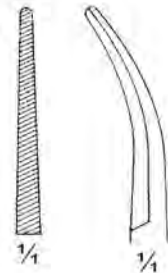

Micro-Halstead  
162-10-10 To 162-17-12

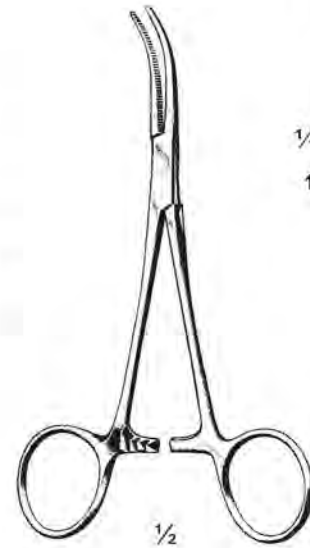
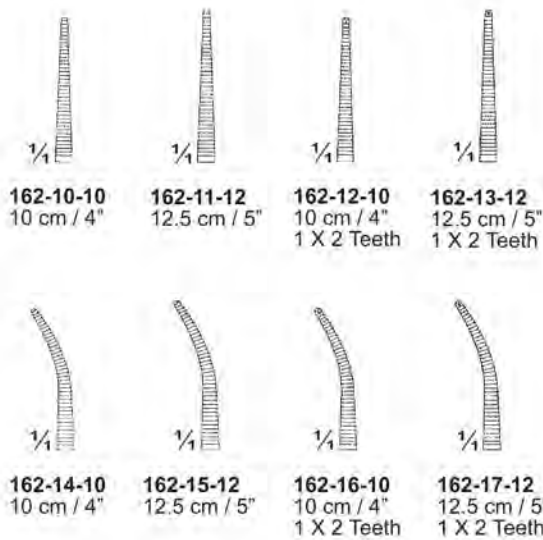

Dandy  
162-18-14 & 162-19-14  
14 cm / 5 1/2"

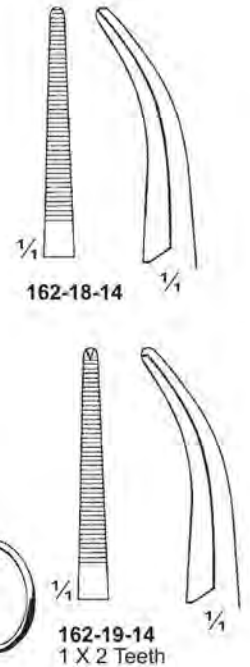

**Arterienklemmen ; Pinzas hemostáticas  
Haemostatic Forceps ; Pinze emostatica  
Pincas hémostatiques ; Pinça hemostatica**



**Halstead-Mosquito  
163-01-18 To 163-08-21**



**163-01-18  
18 cm / 7"**



**163-02-18  
18 cm / 7"**

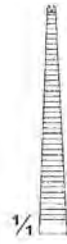

**163-03-18  
18 cm / 7"  
1 X 2 Teeth**



**163-04-18  
18 cm / 7"  
1 X 2 Teeth**



**163-05-21  
21 cm / 8¼"**



**163-06-21  
21 cm / 8¼"**



**163-07-21  
21 cm / 8¼"  
1 X 2 Teeth**



**163-08-21  
21 cm / 8¼"  
1 X 2 Teeth**

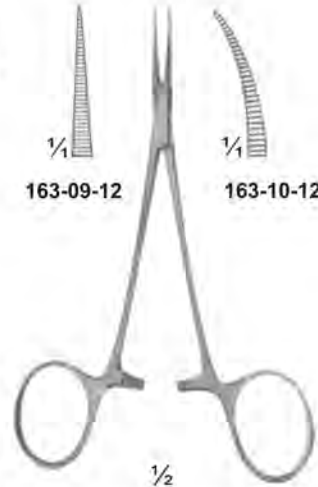

**Jacobson-Micro  
163-09-12 & 163-10-12  
12.5 cm / 5"**



**163-09-12**



**163-10-12**

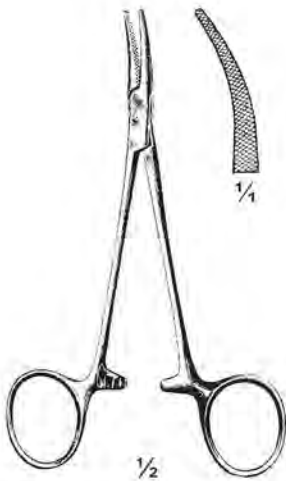

**163-11-12  
12.5 cm / 5"**



**163-12-14**



**163-13-14**



**163-14-14**



**163-15-14**



**163-16-12**



**163-17-12**

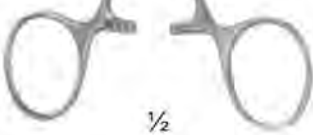

**Providence-Hospital  
163-12-14 & 163-13-14  
14 cm / 5½"**



**Providence-Hospital  
163-14-14 & 163-15-14  
14 cm / 5½"  
1 X 2 Teeth**

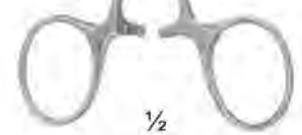

**Skillman  
163-16 & 163-17  
12.5 cm / 5"**

**Arterienklemmen ; Pinzas hemostáticas  
Haemostatic Forceps ; Pinze emostatica  
Pincas hémostatiques ; Pinça hemostatica**

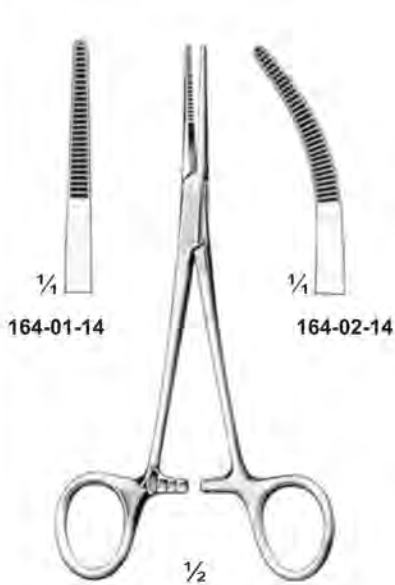

164-01-14

164-02-14

1/2

Kelly  
164-01-14 & 164-02-14  
14 cm / 5 1/2"

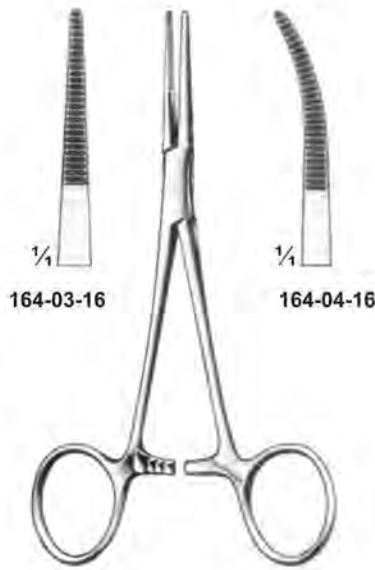

164-03-16

164-04-16

Rankin-Kelly  
164-03-16 & 164-04-16  
16 cm / 6 1/4"



164-05-14

164-06-14

1/2

Crile  
164-05-14 To 164-08-14  
14 cm / 5 1/2"

164-07-14  
1 X 2 Teeth

164-08-14  
1 X 2 Teeth

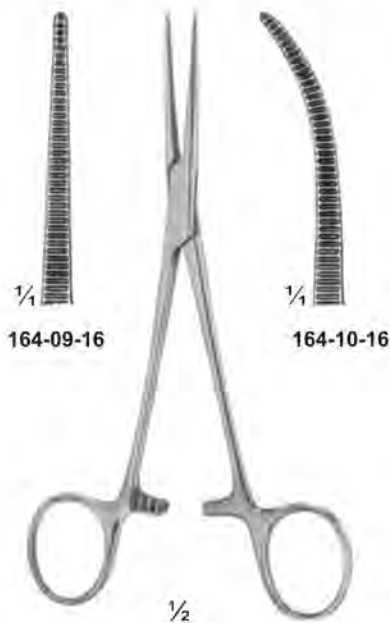

164-09-16

164-10-16

1/2

Rankin-Crile  
164-09-16 & 164-10-16  
16 cm / 6 1/4"

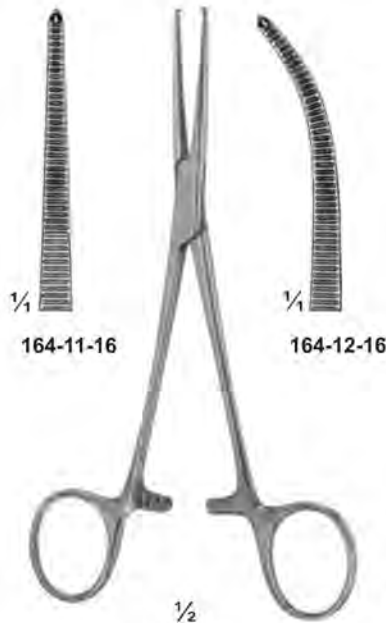

164-11-16

164-12-16

1/2

Rankin-Crile  
164-11-16 & 164-12-16  
16 cm / 6 1/4"  
1 X 2 Teeth



164-13-14

164-14-14

1/2

Baby-Crile  
164-13-14 To 164-16-14  
14 cm / 5 1/2"

164-15-14  
1 X 2 Teeth

164-16-14  
1 X 2 Teeth

**Arterienklemmen ; Pinzas hemostáticas  
Haemostatic Forceps ; Pinze emostatica  
Pincas hémostatiques ; Pinça hemostatica**



**Coller-Crile**  
165-01-14 To 165-05-16



165-01-14  
14 cm / 5½"



165-02-16  
16 cm / 6¼"



165-03-14  
14 cm / 5½"



165-04-16  
16 cm / 6¼"



165-05-16  
16 cm / 6¼"



**Kilner-Kelly**  
165-06-14 To 165-09-14  
14 cm / 5½"



165-06-14



165-07-14



165-08-14  
1 X 2 Teeth



165-09-14  
1 X 2 Teeth

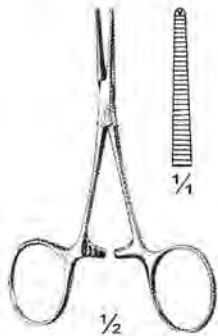

**Terrier**  
165-10-09  
9 cm / 3½"  
1 X 2 Teeth



165-11-10

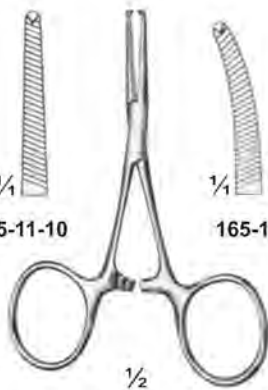

**Terrier**  
165-11-10 & 165-12-10  
10 cm / 4"  
1 X 2 Teeth



165-12-10

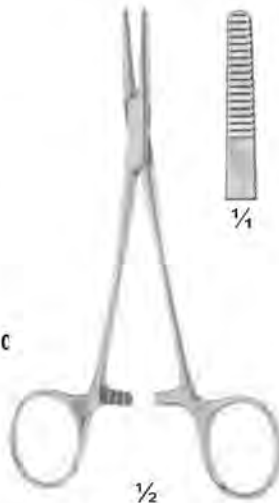

**Terrier**  
165-13-13  
13 cm / 5½"



**Leriche**  
165-14-15 To 165-17-15  
15 cm / 6"



165-14-15



165-15-15



165-16-15  
1 X 2 Teeth



165-17-15  
1 X 2 Teeth

**Arterienklemmen ; Pinzas hemostáticas  
Haemostatic Forceps ; Pinze emostatica  
Pincas hémostatiques ; Pinça hemostatica**



Dixon-Lovelace  
**166-01-16**  
16 cm / 6 1/4"



Dixon-Lovelace  
**166-02-16**  
16 cm / 6 1/4"  
1 X 2 Teeth



Adson  
**166-03-18 & 166-04-18**  
18.5 cm / 7 1/4"

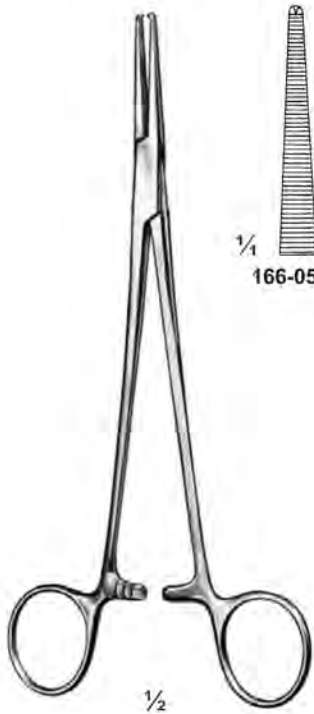

Adson  
**166-05-18 & 166-06-18**  
18.5 cm / 7 1/4"  
1 X 2 Teeth

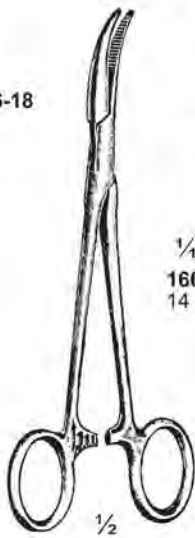
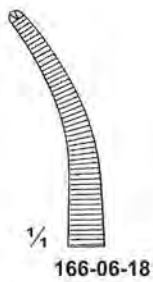

Moynihan  
**166-07-14 & 166-08-14**



**166-09-23**  
23 cm / 9"



**166-10-24**  
24 cm / 9 1/2"



Moynihan  
**166-09-23 & 166-10-24**

**Arterienklemmen ; Pinzas hemostáticas  
Haemostatic Forceps ; Pinze emostatica  
Pinces hémostatiques ; Pinça hemostatica**



$\frac{1}{2}$   
Bengolea  
167-01-20 To 167-12-26



$\frac{1}{4}$   
167-01-20  
20 cm / 8"



$\frac{1}{4}$   
167-02-20  
20 cm / 8"



$\frac{1}{4}$   
167-03-24  
24 cm / 9½"



$\frac{1}{4}$   
167-04-24  
24 cm / 9½"



$\frac{1}{4}$   
167-05-26  
26 cm / 10¼"



$\frac{1}{4}$   
167-06-26  
26 cm / 10¼"



$\frac{1}{4}$   
167-07-20  
20 cm / 8"  
1 X 2 Teeth



$\frac{1}{4}$   
167-08-20  
20 cm / 8"  
1 X 2 Teeth



$\frac{1}{4}$   
167-09-24  
24 cm / 9½"  
1 X 2 Teeth



$\frac{1}{4}$   
167-10-24  
24 cm / 9½"  
1 X 2 Teeth



$\frac{1}{4}$   
167-11-26  
26 cm / 10¼"  
1 X 2 Teeth



$\frac{1}{4}$   
167-12-26  
26 cm / 10¼"  
1 X 2 Teeth



$\frac{1}{2}$   
Bengolea  
167-13-20 To 167-20-23



$\frac{1}{4}$   
167-13-20  
20 cm / 8"



$\frac{1}{4}$   
167-14-23  
23 cm / 9"



$\frac{1}{4}$   
167-15-20  
20 cm / 8"



$\frac{1}{4}$   
167-16-23  
23 cm / 9"



$\frac{1}{4}$   
167-17-20  
20 cm / 8"  
1 X 2 Teeth



$\frac{1}{4}$   
167-18-23  
23 cm / 9"  
1 X 2 Teeth



$\frac{1}{4}$   
167-19-20  
20 cm / 8"  
1 X 2 Teeth



$\frac{1}{4}$   
167-20-23  
23 cm / 9"  
1 X 2 Teeth





**Arterienklemmen ; Pinzas hemostáticas  
Haemostatic Forceps ; Pinze emostatica  
Pincas hémostatiques ; Pinça hemostatica**



1/2

Rochester-Pean  
168-01-12 To 168-09-30

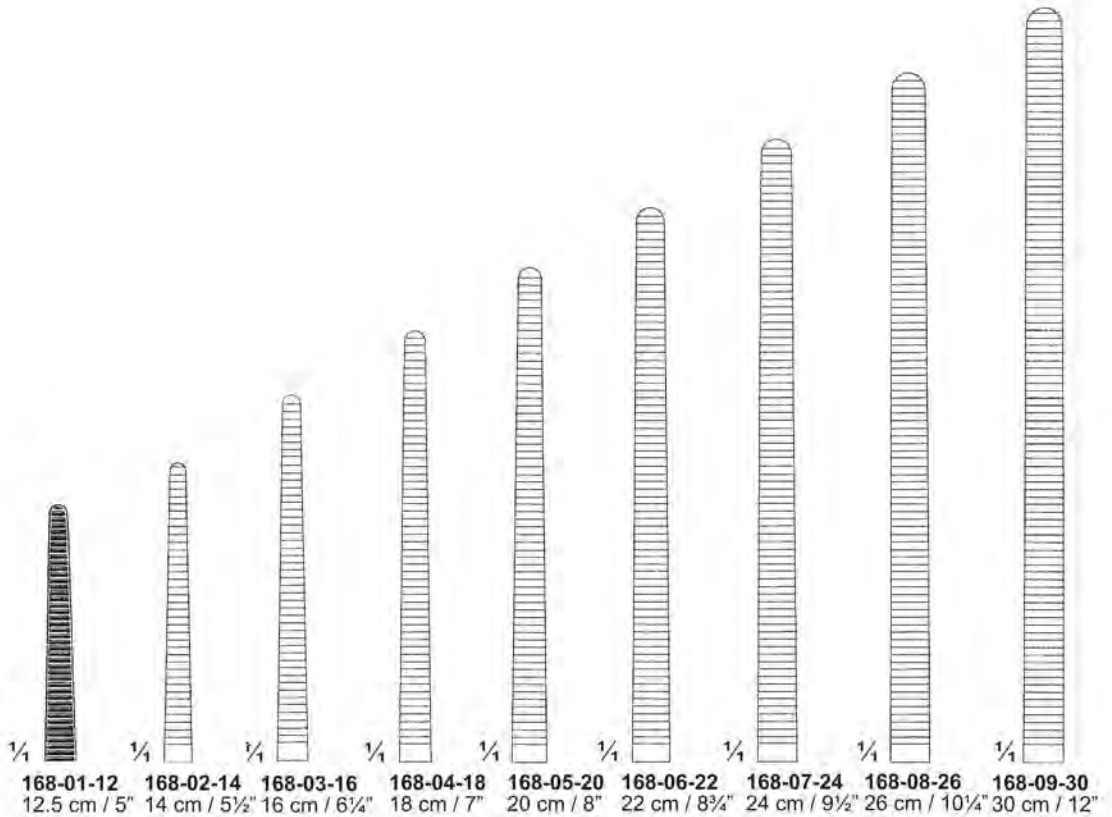

1/2

Rochester-Pean  
168-10-12 To 168-18-30

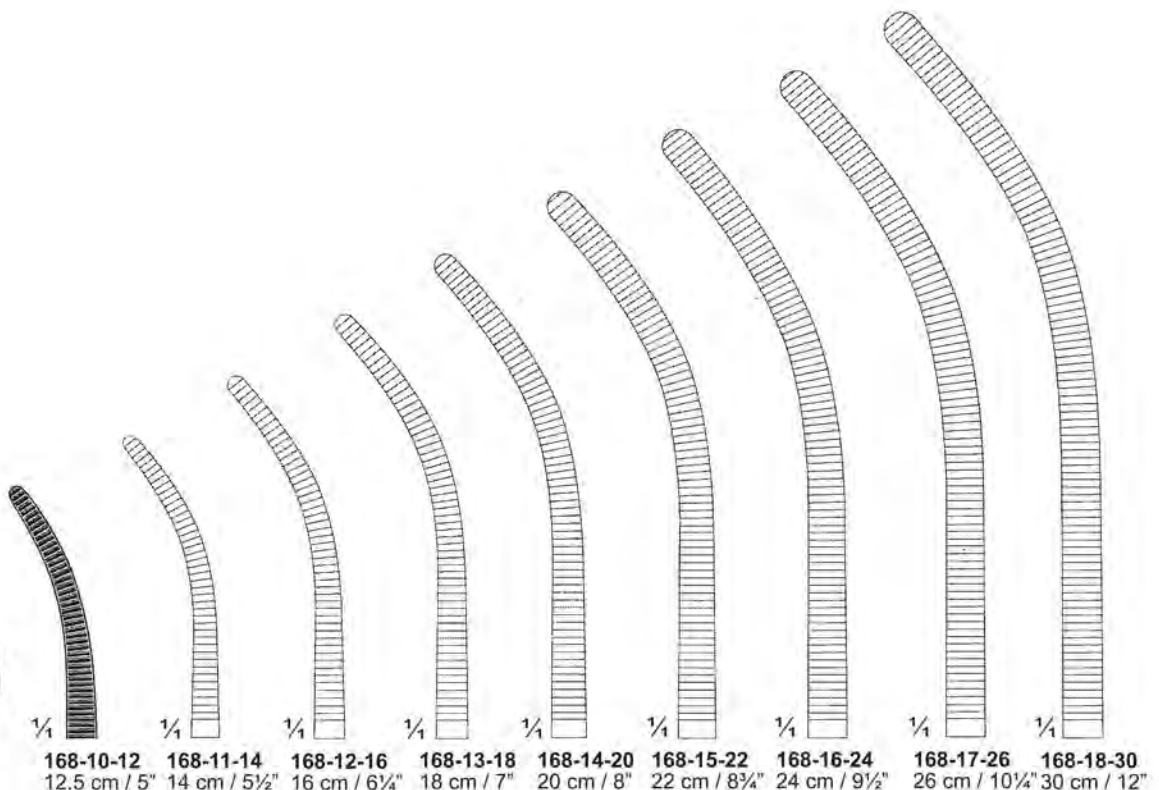

**Arterienklemmen ; Pinzas hemostáticas  
Haemostatic Forceps ; Pinze emostatica  
Pincas hémostatiques ; Pinça hemostatica**



Pean  
169-01-12 To 169-06-16

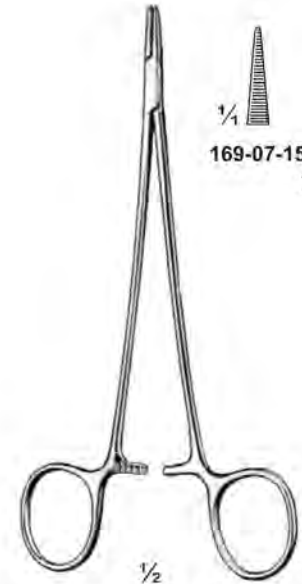
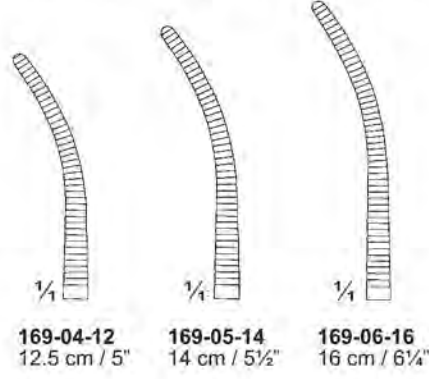
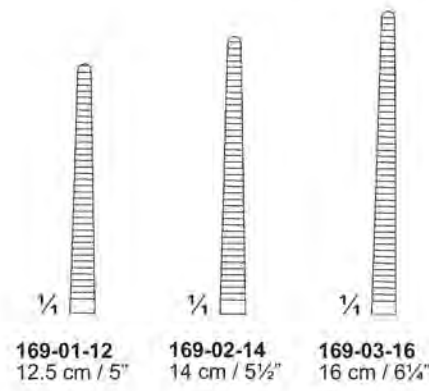

169-07-15 & 169-08-15  
15 cm / 6"

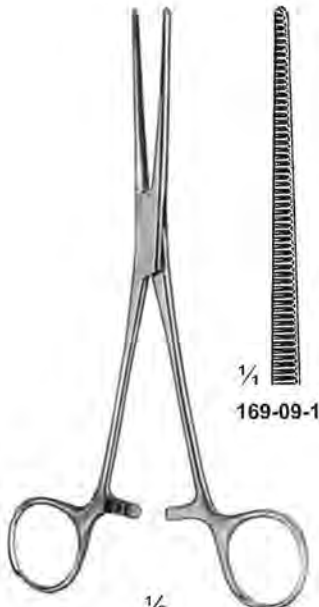
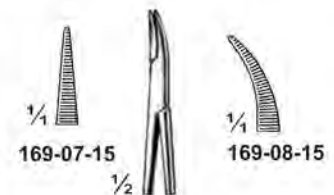

Pean-Dixon  
169-09-16 & 169-10-16  
16 cm / 6 1/4"

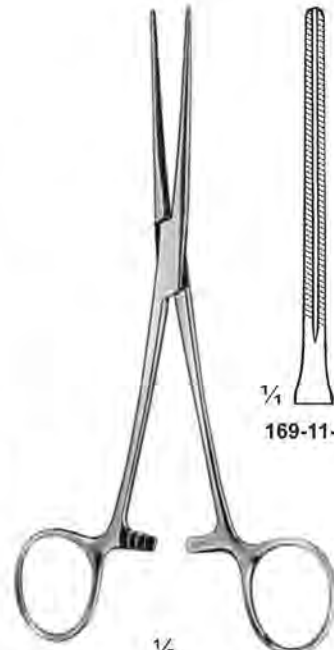
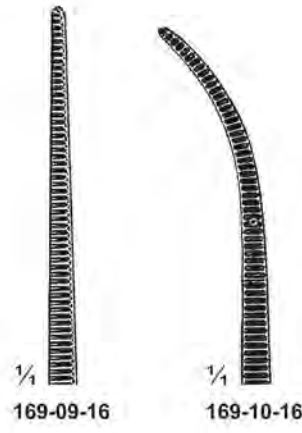

Bainbridge-Glassman  
169-11-16 & 169-12-16  
16.5 cm / 6 1/2"

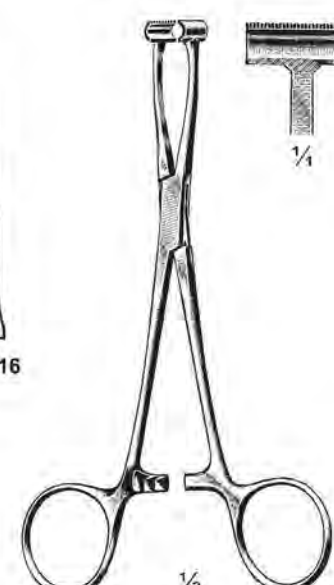
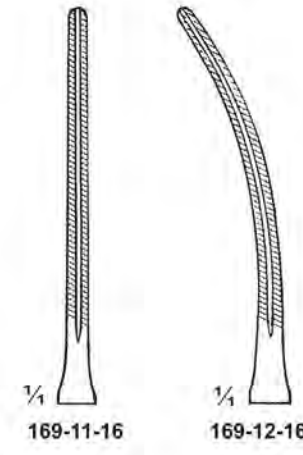

Pratt  
169-13-15  
15 cm / 6"



**Arterienklemmen ; Pinzas hemostáticas  
Haemostatic Forceps ; Pinze emostatica  
Pincas hémostatiques ; Pinça hemostatica**



**Pean-Nippon  
170-01-14 To 170-06-18**

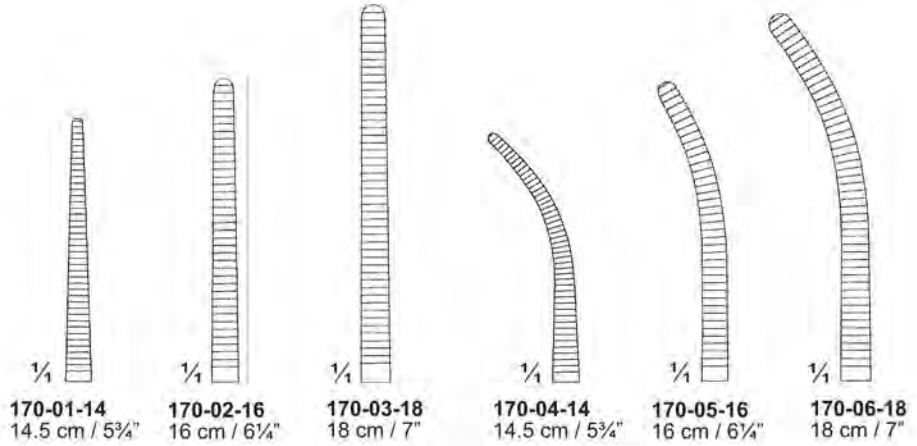

<b>170-01-14</b> 14.5 cm / 5 3/4"	<b>170-02-16</b> 16 cm / 6 1/4"	<b>170-03-18</b> 18 cm / 7"	<b>170-04-14</b> 14.5 cm / 5 3/4"	<b>170-05-16</b> 16 cm / 6 1/4"	<b>170-06-18</b> 18 cm / 7"
--------------------------------------	------------------------------------	--------------------------------	--------------------------------------	------------------------------------	--------------------------------

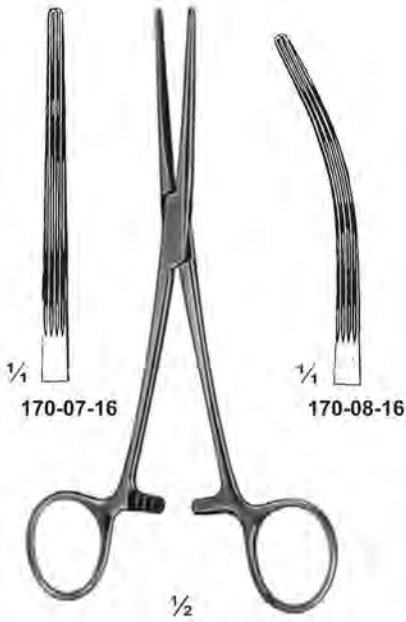

**Bainbridge-Baby  
170-07-16 & 170-08-16  
16 cm / 6 1/4"**

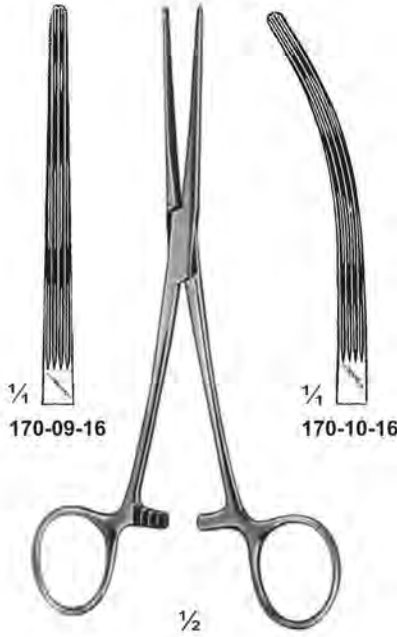

**Bainbridge  
170-09-16 & 170-10-16  
16.5 cm / 6 1/2"**

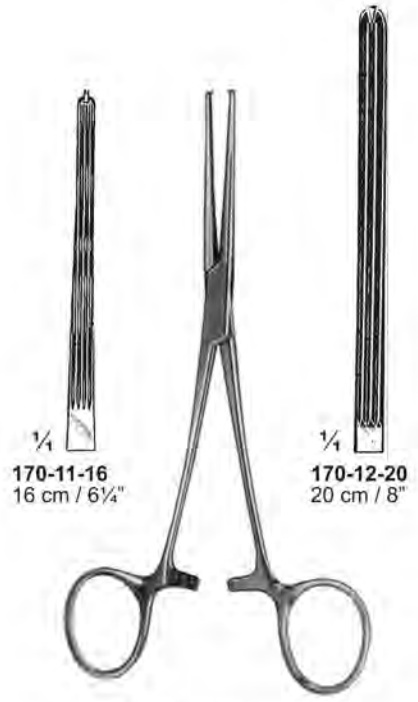

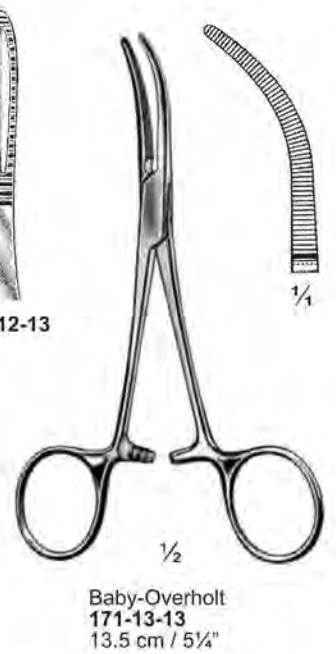
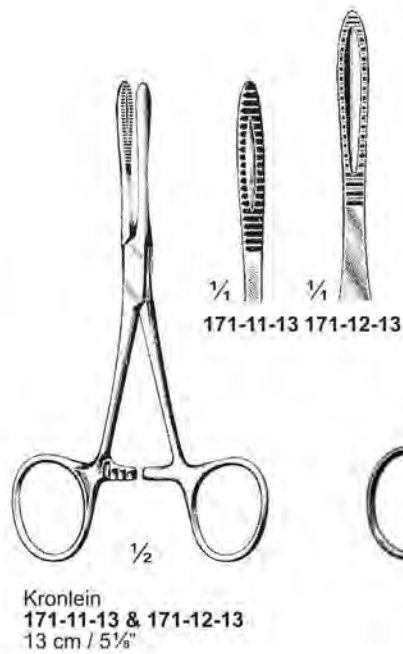
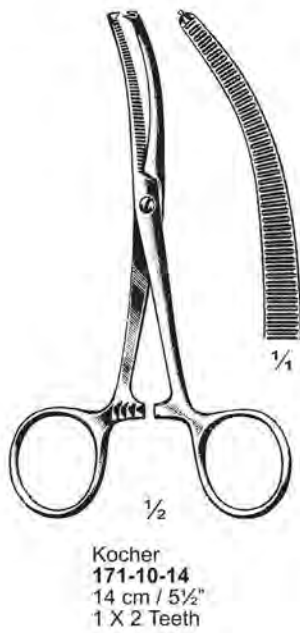
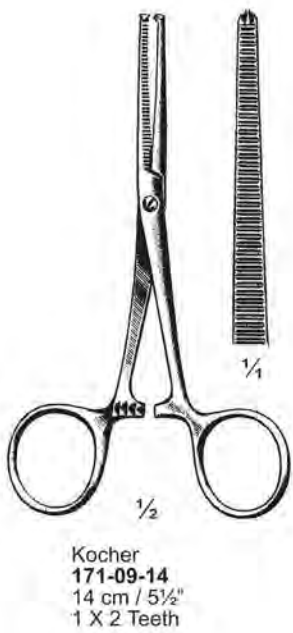
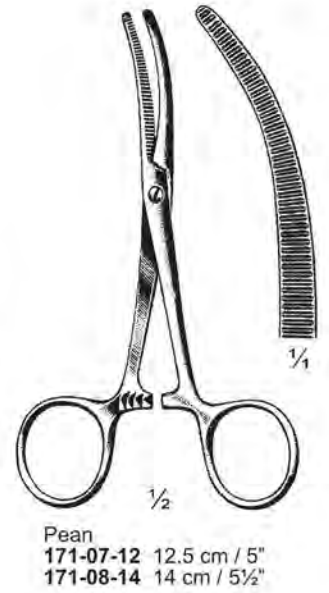
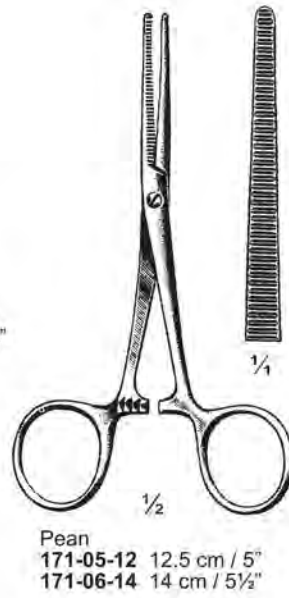
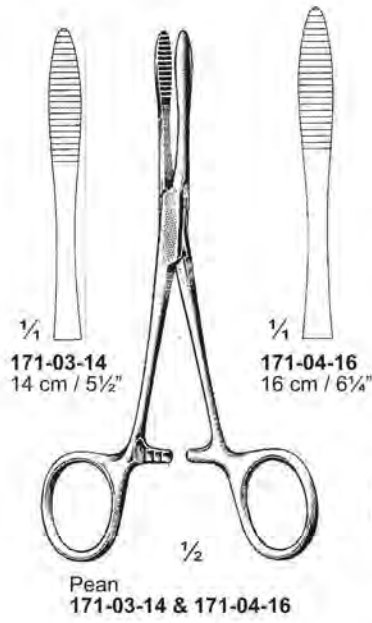
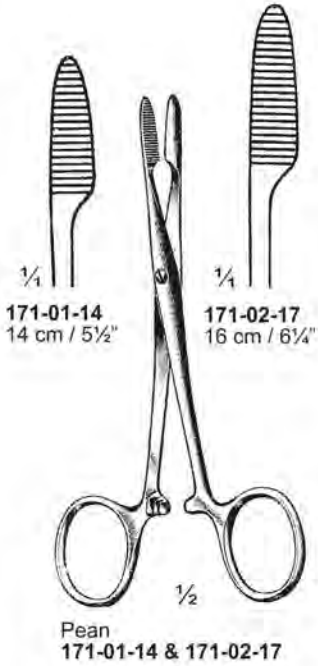

**Allen-Kocher  
170-11-16 & 170-12-20  
1 X 2 Teeth**

**Arterienklemmen ; Pinzas hemostáticas  
Haemostatic Forceps ; Pinze emostatica  
Pincas hémostatiques ; Pinça hemostatica**



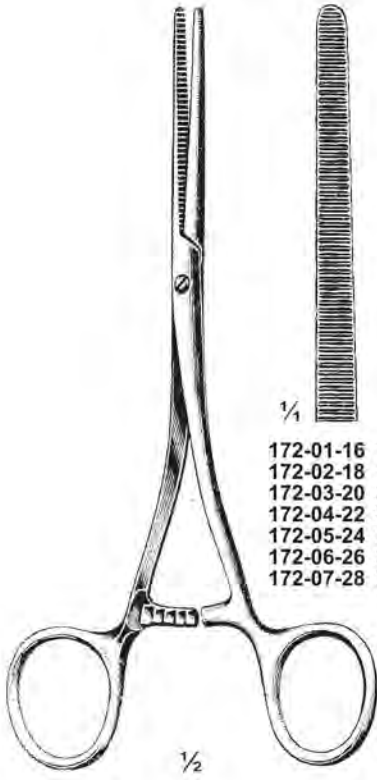

**Arterienklemmen ; Pinzas hemostáticas  
Haemostatic Forceps ; Pinze emostatica  
Pincas hémostatiques ; Pinça hemostatica**

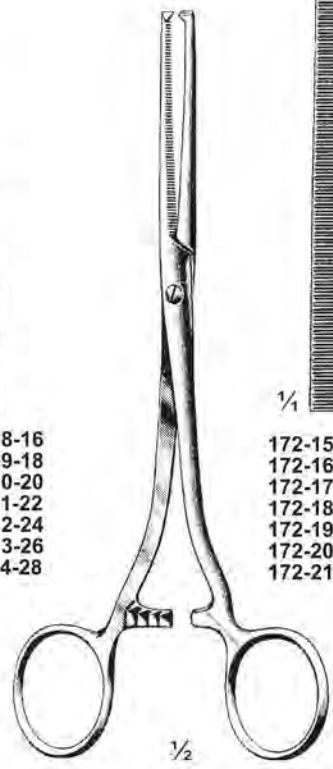

- |                  |   |                  |   |
|------------------|---|------------------|---|
| $\frac{1}{4}$    |  | $\frac{1}{4}$    |  |
| <b>172-01-16</b> | 16 cm / 6 $\frac{1}{4}$ "   | <b>172-08-16</b> |   |
| <b>172-02-18</b> | 18 cm / 7"  | <b>172-09-18</b> |   |
| <b>172-03-20</b> | 20 cm / 8"  | <b>172-10-20</b> |   |
| <b>172-04-22</b> | 22 cm / 8 $\frac{3}{4}$ "   | <b>172-11-22</b> |   |
| <b>172-05-24</b> | 24 cm / 9 $\frac{1}{2}$ "   | <b>172-12-24</b> |   |
| <b>172-06-26</b> | 26 cm / 10 $\frac{1}{4}$ "  | <b>172-13-26</b> |   |
| <b>172-07-28</b> | 28 cm / 11"   | <b>172-14-28</b> |   |

Pean  
172-01-16 To 172-14-28



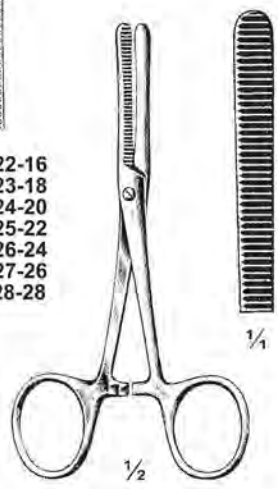

- |                  |   |                  |   |
|------------------|---|------------------|---|
| $\frac{1}{4}$    |  | $\frac{1}{4}$    |  |
| <b>172-15-16</b> | 16 cm / 6 $\frac{1}{4}$ "   | <b>172-22-16</b> |   |
| <b>172-16-18</b> | 18 cm / 7"  | <b>172-23-18</b> |   |
| <b>172-17-20</b> | 20 cm / 8"  | <b>172-24-20</b> |   |
| <b>172-18-22</b> | 22 cm / 8 $\frac{3}{4}$ "   | <b>172-25-22</b> |   |
| <b>172-19-24</b> | 24 cm / 9 $\frac{1}{2}$ "   | <b>172-26-24</b> |   |
| <b>172-20-26</b> | 26 cm / 10 $\frac{1}{4}$ "  | <b>172-27-26</b> |   |
| <b>172-21-28</b> | 28 cm / 11"   | <b>172-28-28</b> |   |

Kocher  
172-15-16 To 172-28-28  
1 X 2 Teeth



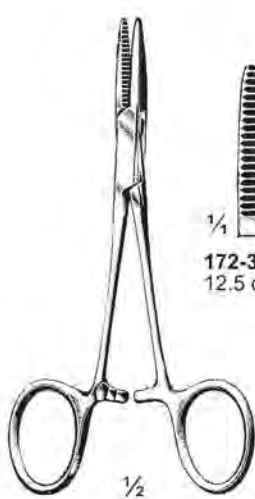

Pean  
172-29-12 12.5 cm / 5"  
172-30-16 16 cm / 6 $\frac{1}{4}$ "



- |                  |   |                  |   |
|------------------|---|------------------|---|
| $\frac{1}{4}$    |  | $\frac{1}{4}$    |  |
| <b>172-31-12</b> | 12.5 cm / 5"  | <b>172-32-15</b> | 15 cm / 6"  |

Jones (Spencer-Wells)  
172-31-12 & 172-32-15



- |                  |   |                  |  |
|------------------|---|------------------|--|
| $\frac{1}{4}$    |  | $\frac{1}{4}$    |  |
| <b>172-33-12</b> | 12.5 cm / 5"  | <b>172-34-15</b> | 15 cm / 6"   |

Jones (Spencer-Wells)  
172-33-12 & 172-34-15

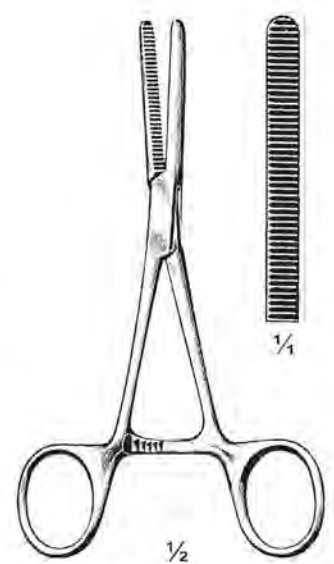

Mod. Klinikum Berlin  
172-35-14 14.5 cm / 5 $\frac{3}{4}$ "  
172-36-16 16 cm / 6 $\frac{1}{4}$ "

**Arterienklemmen ; Pinzas hemostáticas  
Haemostatic Forceps ; Pinze emostatica  
Pincas hémostatiques ; Pinça hemostatica**



Spencer-Wells  
173-01-13 To 173-10-20



173-01-13  
13 cm / 5 1/8"



173-02-14  
14 cm / 5 1/2"



173-03-15  
15 cm / 6"



173-04-18  
18 cm / 7"



173-05-20  
20 cm / 8"



173-06-13  
13 cm / 5 1/8"



173-07-14  
14 cm / 5 1/2"



173-08-15  
15 cm / 6"



173-09-18  
18 cm / 7"



173-10-20  
20 cm / 8"



Spencer-Wells  
173-11-15 To 173-13-20



173-11-15  
15 cm / 6"



173-12-18  
18 cm / 7"



173-13-20  
20 cm / 8"



Kocher  
173-14-15 To 173-16-20  
1 X 2 Teeth



173-14-15  
15 cm / 6"



173-15-18  
18 cm / 7"



173-16-20  
20 cm / 8"

**Arterienklemmen ; Pinzas hemostáticas  
Haemostatic Forceps ; Pinze emostatica  
Pincas hémostatiques ; Pinça hemostatica**



**Kocher (Ochsner)**  
**174-01-20 TO 174-08-30**  
1 X 2 Teeth

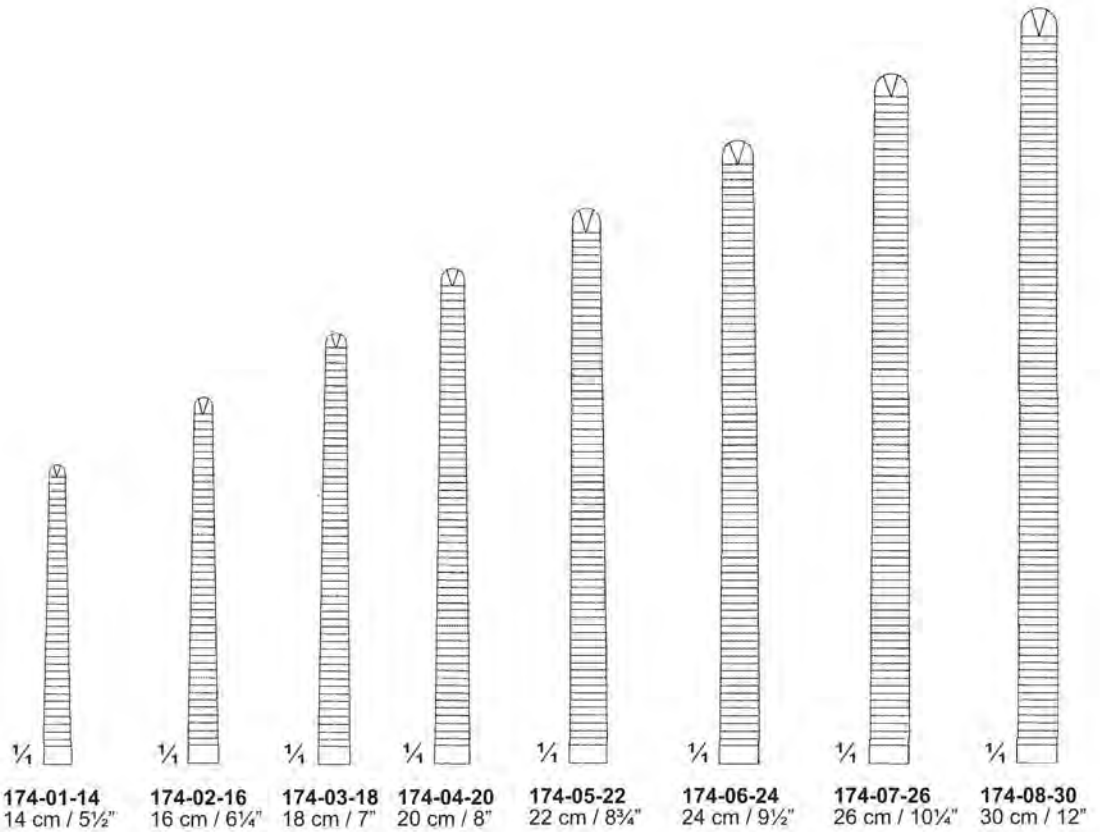

$\frac{1}{4}$	$\frac{1}{4}$	$\frac{1}{4}$	$\frac{1}{4}$	$\frac{1}{4}$	$\frac{1}{4}$	$\frac{1}{4}$	$\frac{1}{4}$	$\frac{1}{4}$
<b>174-01-14</b>	<b>174-02-16</b>	<b>174-03-18</b>	<b>174-04-20</b>	<b>174-05-22</b>	<b>174-06-24</b>	<b>174-07-26</b>	<b>174-08-30</b>	
14 cm / 5½"	16 cm / 6¼"	18 cm / 7"	20 cm / 8"	22 cm / 8¾"	24 cm / 9½"	26 cm / 10¼"	30 cm / 12"	

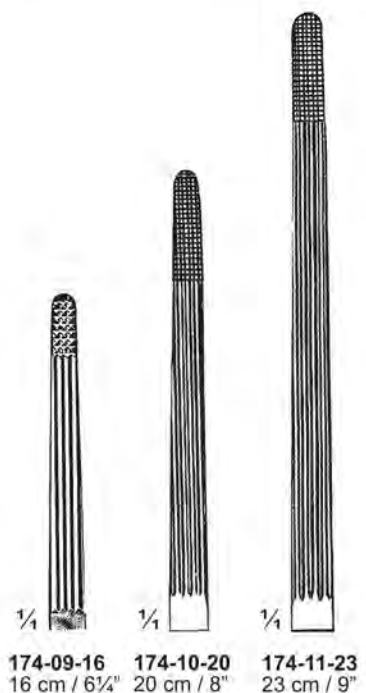

$\frac{1}{4}$	$\frac{1}{4}$	$\frac{1}{4}$
<b>174-09-16</b>	<b>174-10-20</b>	<b>174-11-23</b>
16 cm / 6¼"	20 cm / 8"	23 cm / 9"

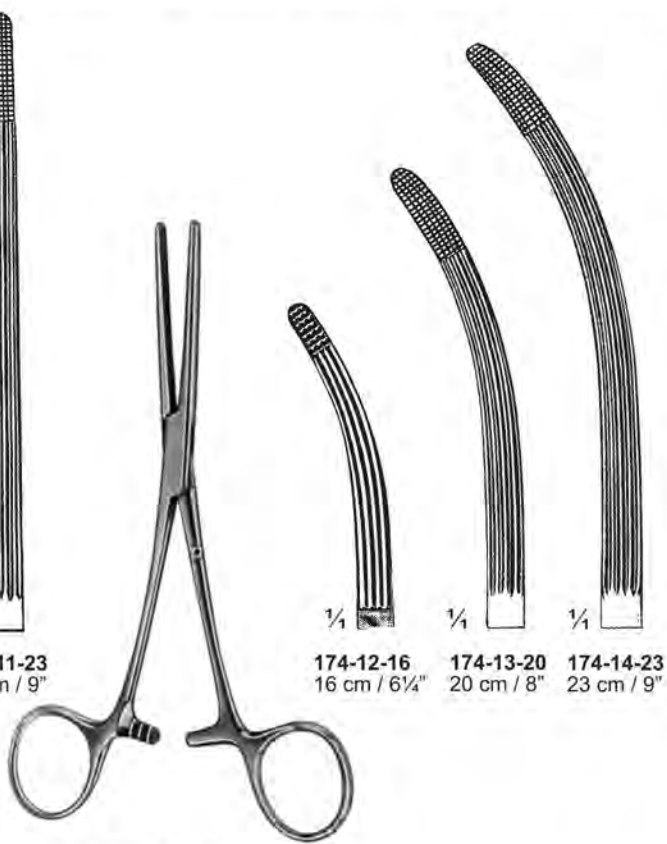

$\frac{1}{4}$	$\frac{1}{4}$	$\frac{1}{4}$
<b>174-12-16</b>	<b>174-13-20</b>	<b>174-14-23</b>
16 cm / 6¼"	20 cm / 8"	23 cm / 9"

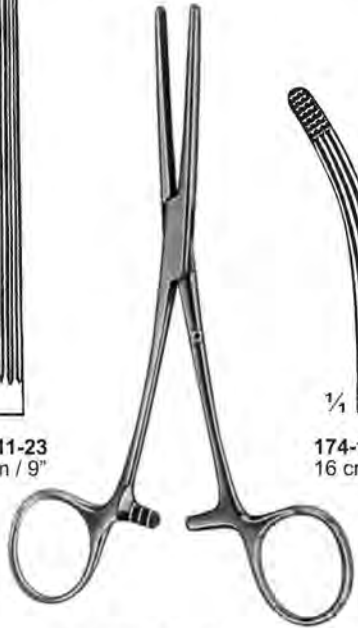

**Rochester-Carmalt**  
**174-09-16 To 174-14-23**

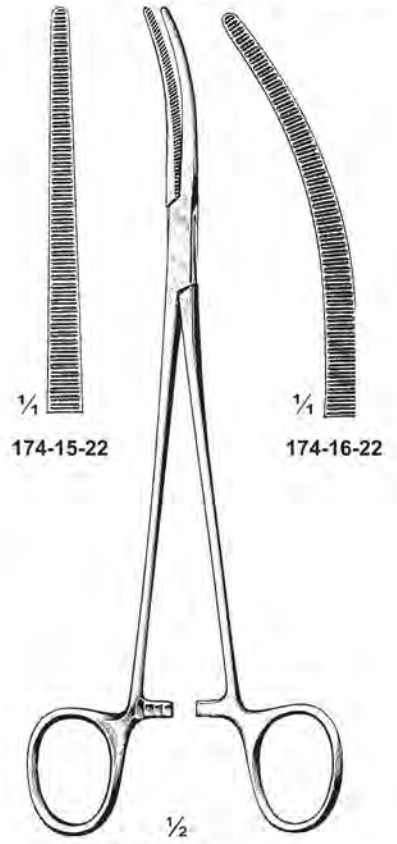

$\frac{1}{4}$	$\frac{1}{4}$
<b>174-15-22</b>	<b>174-16-22</b>

**Roberts**  
**174-15-22 & 174-16-22**  
22 cm / 8¾"

**Arterienklemmen ; Pinzas hemostáticas  
Haemostatic Forceps ; Pinze emostatica  
Pincas hémostatiques ; Pinça hemostatica**



**Kocher (Ochsner)**  
**174-01-20 TO 174-08-30**  
1 X 2 Teeth

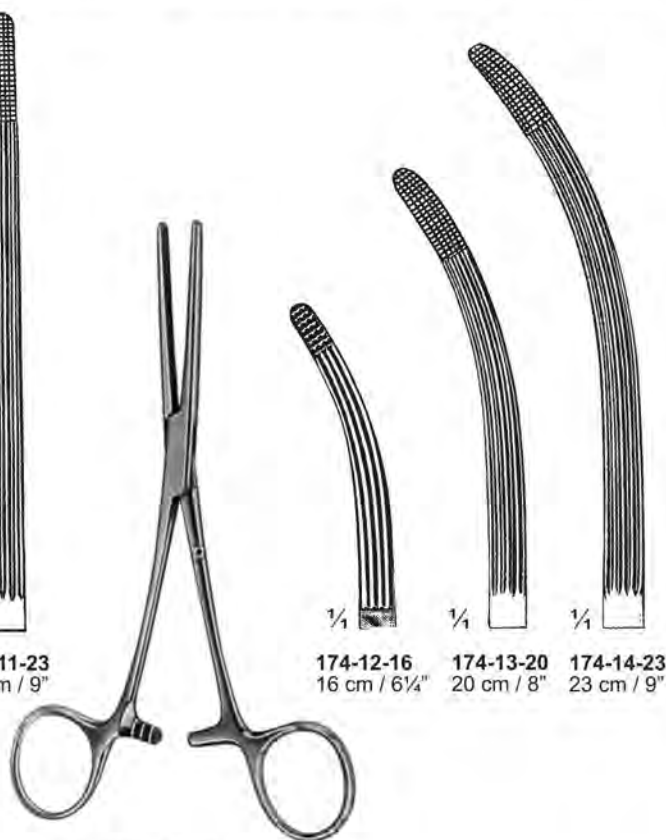
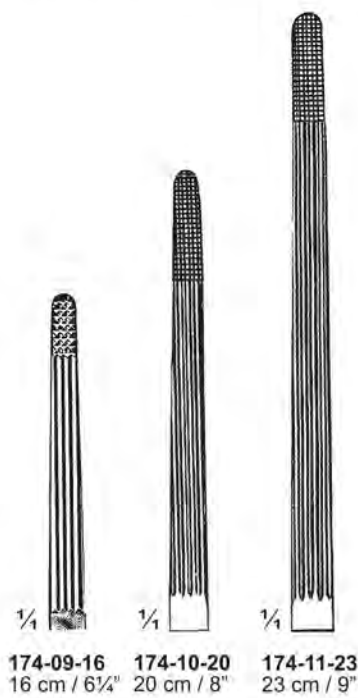
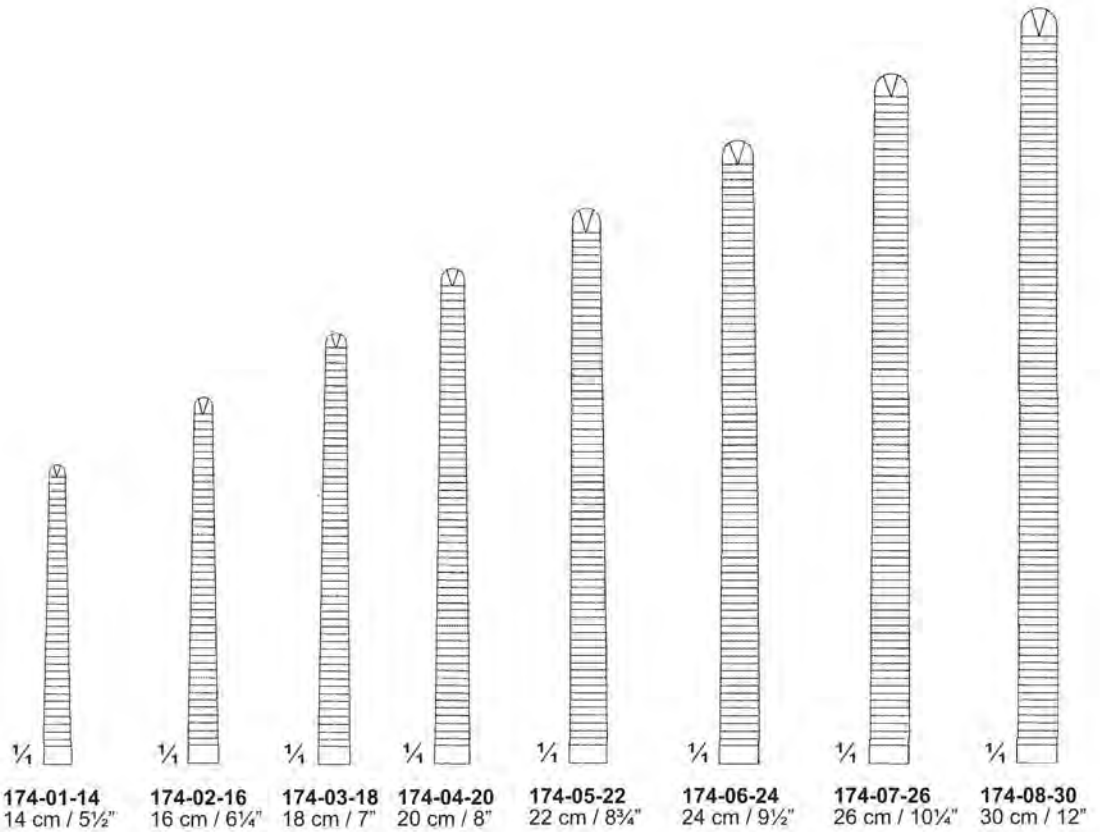

**Rochester-Carmalt**  
**174-09-16 To 174-14-23**

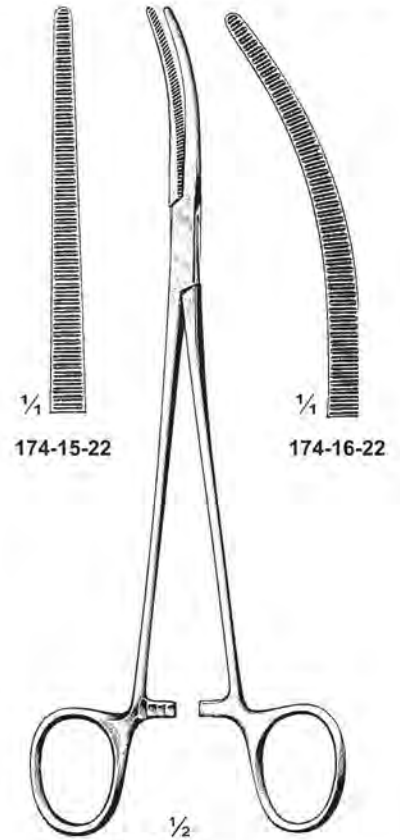

**Roberts**  
**174-15-22 & 174-16-22**  
22 cm / 8¾"



**Arterienklemmen ; Pinzas hemostáticas  
Haemostatic Forceps ; Pinze emostatica  
Pincas hémostatiques ; Pinça hemostatica**

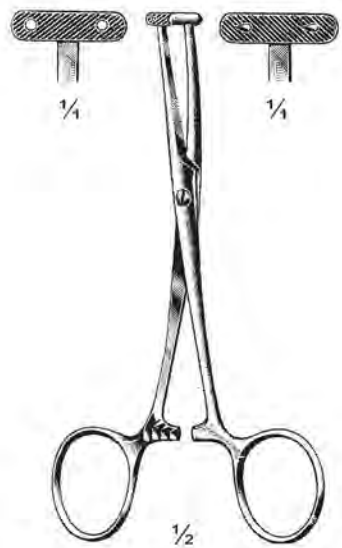
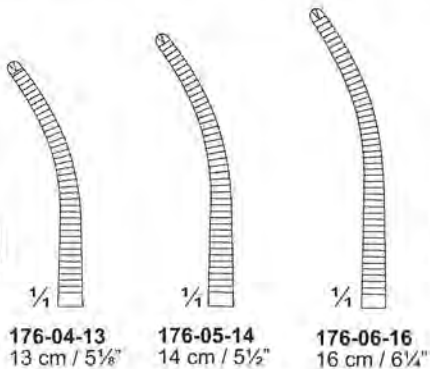
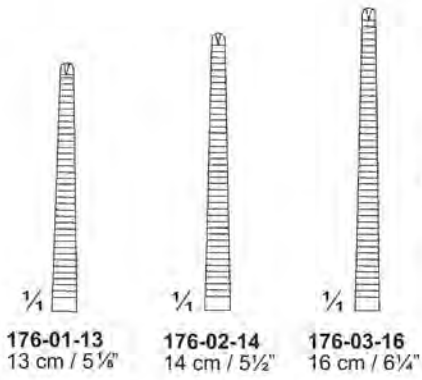

**Kocher**  
**176-01-13 To 176-06-16**  
1 X 2 Teeth  
Delicate

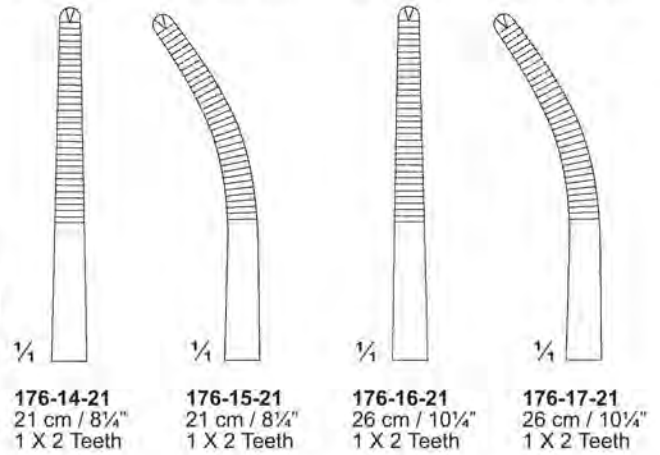
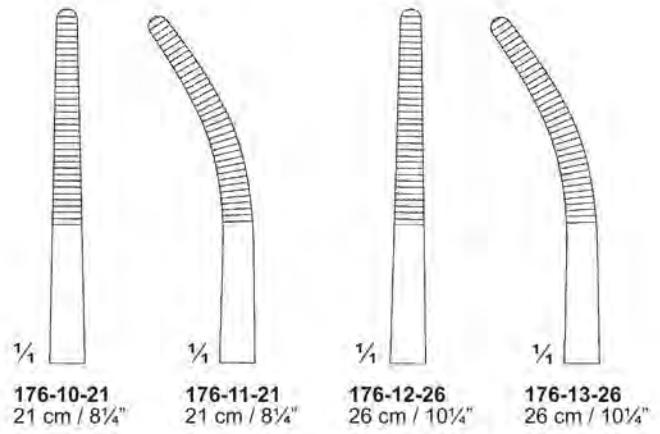
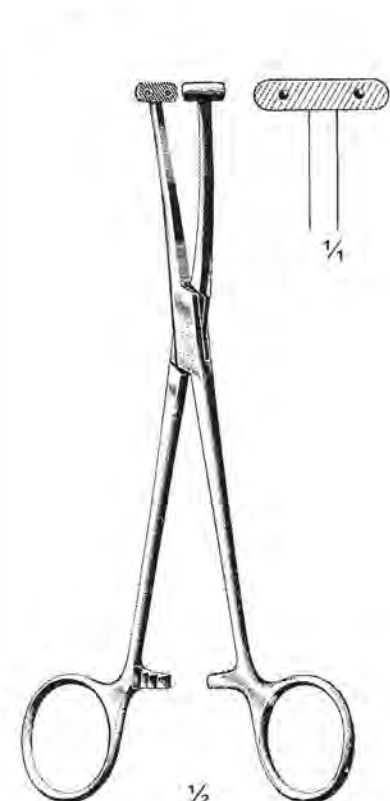

**Arterienklemmen ; Pinzas hemostáticas  
Haemostatic Forceps ; Pinze emostatica  
Pincas hémostatiques ; Pinça hemostatica**

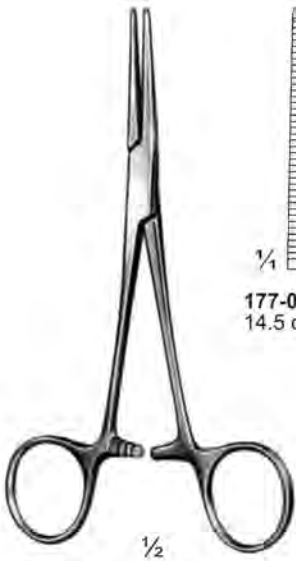

1/2

**Kocher-Nippon**  
177-01-14 To 177-06-18  
1 X 2 Teeth

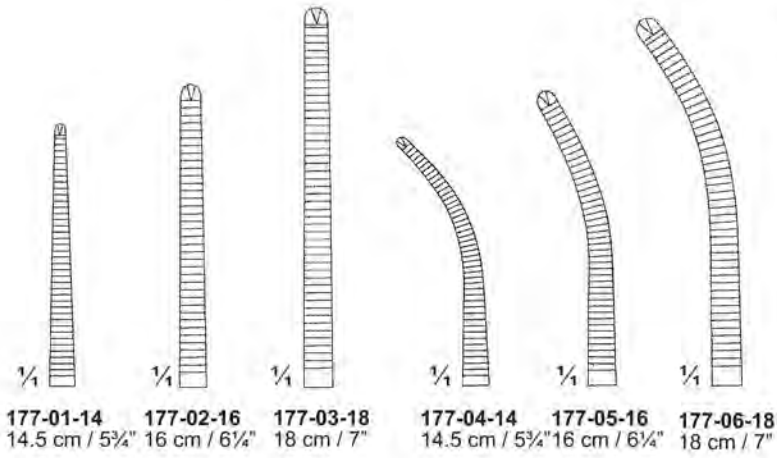

177-01-14 177-02-16 177-03-18 177-04-14 177-05-16 177-06-18  
14.5 cm / 5 3/4" 16 cm / 6 1/4" 18 cm / 7" 14.5 cm / 5 3/4" 16 cm / 6 1/4" 18 cm / 7"

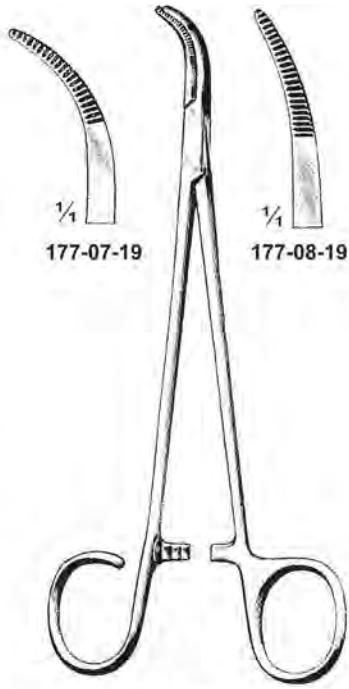

**Schnidt**  
177-07-19 & 177-08-19  
19 cm / 7 1/2"

177-07-19 177-08-19

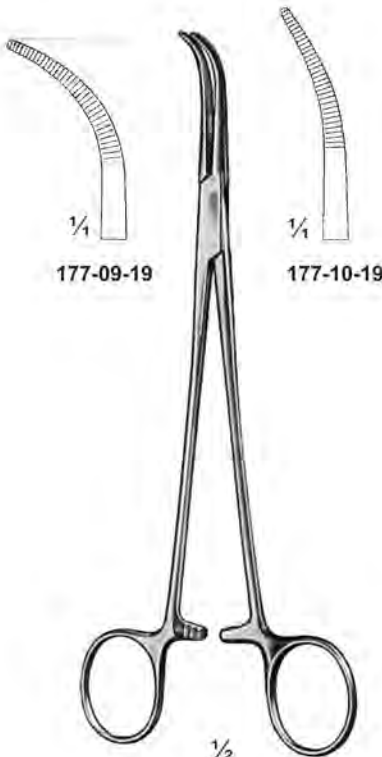

**Schnidt**  
177-09-19 & 177-10-19  
19 cm / 7 1/2"

177-09-19 177-10-19



**Halstead**  
177-11-21 & 177-12-21  
21 cm / 8 1/4"

177-11-21 177-12-21  
1 X 2 Teeth

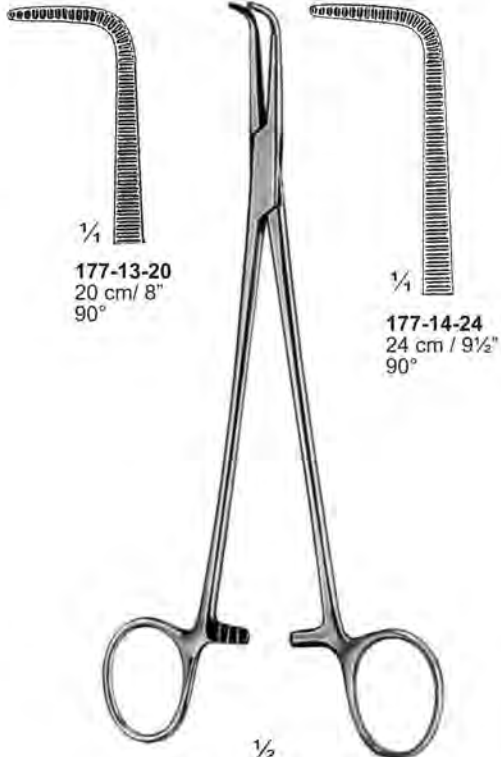

**Heiss**  
177-13-20 & 177-14-24

177-13-20 20 cm / 8" 90°  
177-14-24 24 cm / 9 1/2" 90°

**Arterienklemmen ; Pinzas hemostáticas  
Haemostatic Forceps ; Pinze emostatica  
Pincas hémostatiques ; Pinça hemostatica**

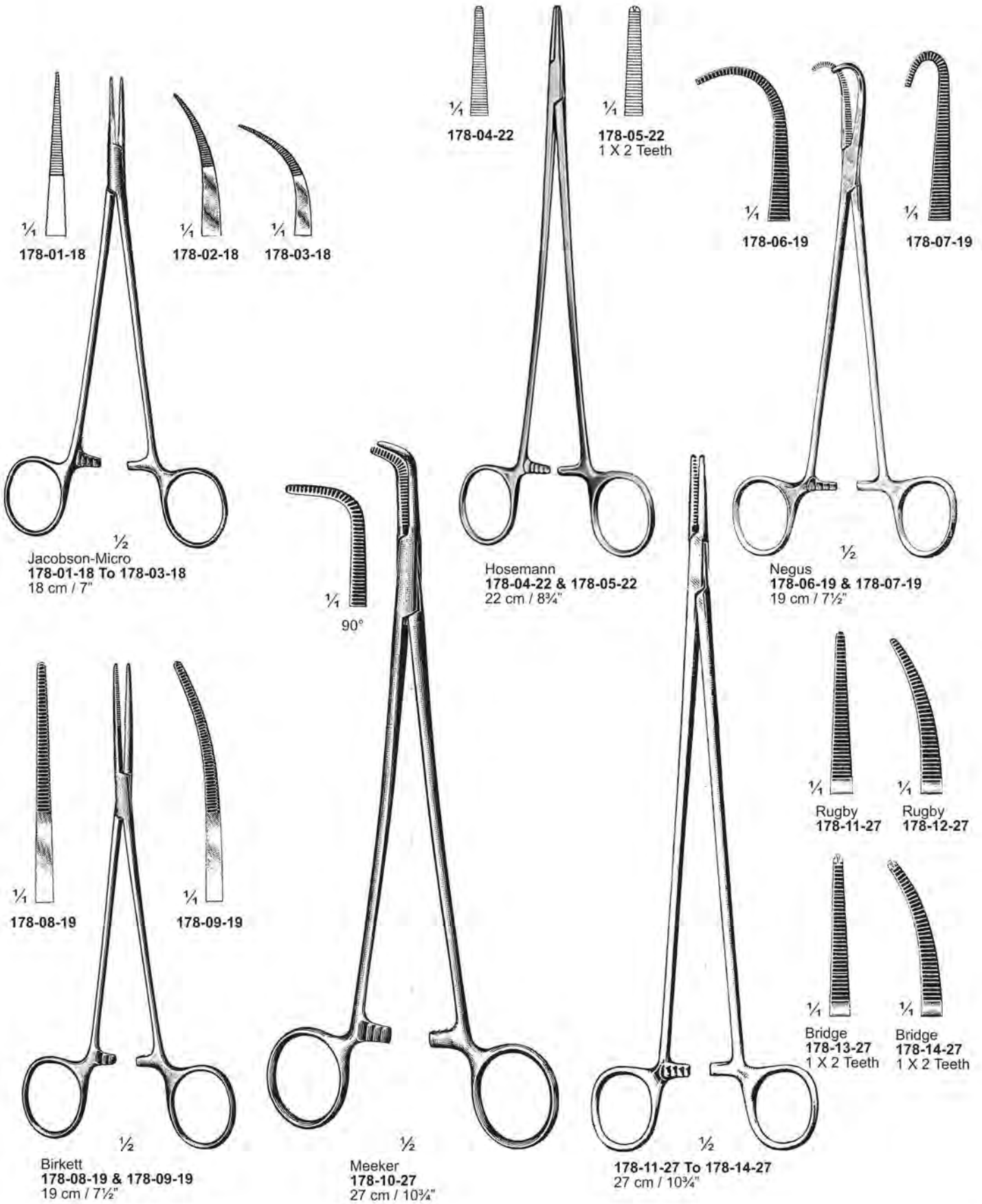

¼  
178-01-18

¼  
178-02-18

¼  
178-03-18

¼  
178-04-22

¼  
178-05-22  
1 X 2 Teeth

¼  
178-06-19

¼  
178-07-19

½  
Jacobson-Micro  
178-01-18 To 178-03-18  
18 cm / 7"

Hosemann  
178-04-22 & 178-05-22  
22 cm / 8¾"

½  
Negus  
178-06-19 & 178-07-19  
19 cm / 7½"

¼  
90°

¼  
178-08-19

¼  
178-09-19

¼  
Rugby  
178-11-27

¼  
Rugby  
178-12-27

¼  
Bridge  
178-13-27  
1 X 2 Teeth

¼  
Bridge  
178-14-27  
1 X 2 Teeth

½  
Birkett  
178-08-19 & 178-09-19  
19 cm / 7½"

½  
Meeker  
178-10-27  
27 cm / 10¾"

½  
178-11-27 To 178-14-27  
27 cm / 10¾"

Darm- & Gewebefasszangen ; Pinzas para coger intestinos y tejidos  
 Intestinal & Tissue Forceps ; Pinze per afferare intestini e tessuti  
 Pincas à saisir l'intestin & le tissus ; Pinças para pegar os intestinos e tecidos



Chaput  
179-01-14  
14 cm / 5½"



Chaput  
179-02-13  
13 cm / 5⅛"



Tuffier  
179-03-14  
14 cm / 5½"

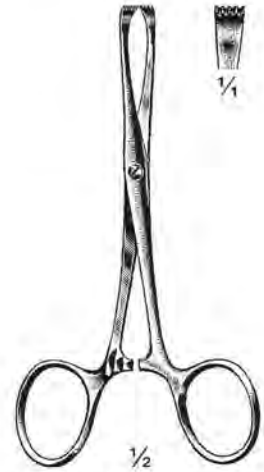

Tuffier  
179-04-13  
13 cm / 5⅛"

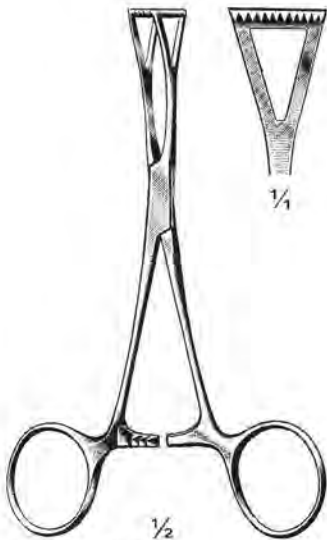

Collin  
179-05-14  
14 cm / 5½"

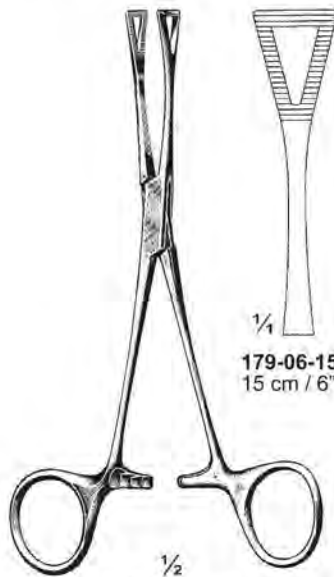

Pennington  
179-06-15 & 179-07-20

179-06-15  
15 cm / 6"



179-07-20  
20 cm / 8"



Collin  
179-09-16  
16.5 cm / 6½"



Darm- & Gewebefasszangen ; Pinzas para coger intestinos y tejidos  
 Intestinal & Tissue Forceps ; Pinze per afferare intestini e tessuti  
 Pincès à saisir l'intestin & le tissu ; Pinças para pegar os intestinos e tecidos



180-01-25 & 180-02-26  
Atrauma



1/4  
180-01-25  
25 cm / 10"

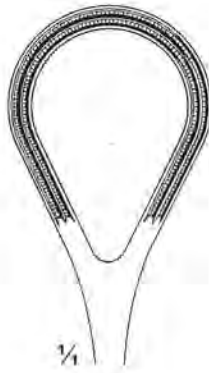

1/4  
180-02-26  
26 cm / 10 1/4"

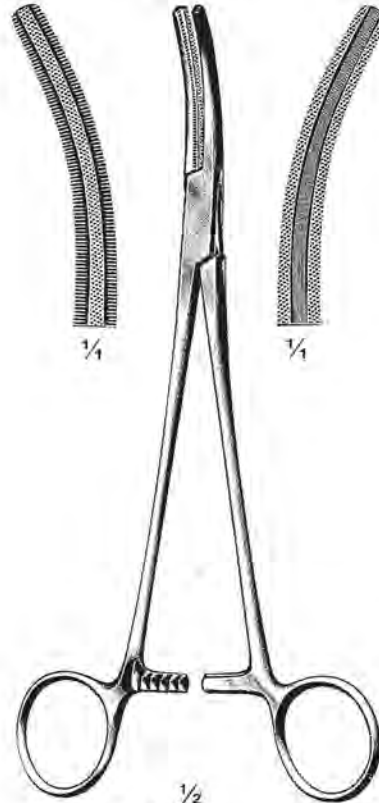
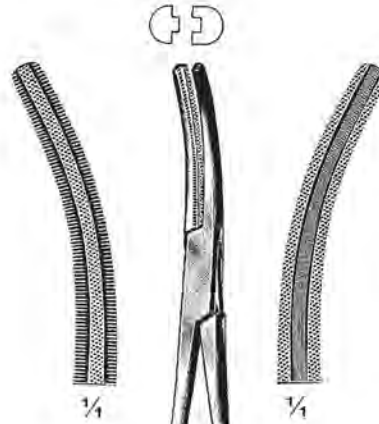

1/2  
Buie  
180-03-21  
21 cm / 8 1/4"

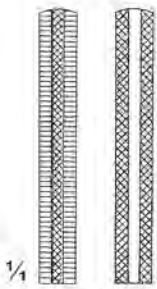

1/4  
180-04-16  
16 cm / 6 1/4"

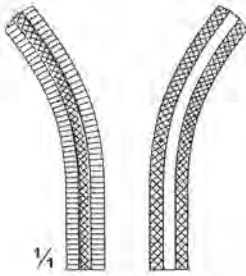

1/4  
180-05-16  
16 cm / 6 1/4"

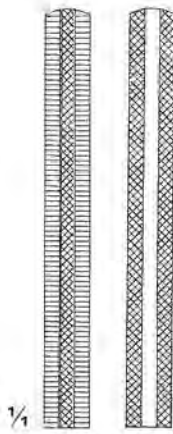

1/4  
180-06-20  
20 cm / 8"

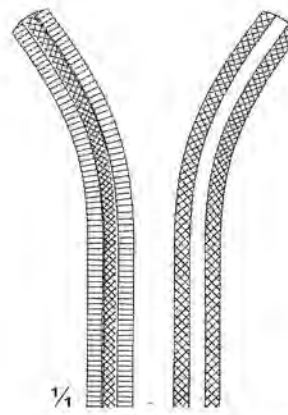

1/4  
180-07-20  
20 cm / 8"

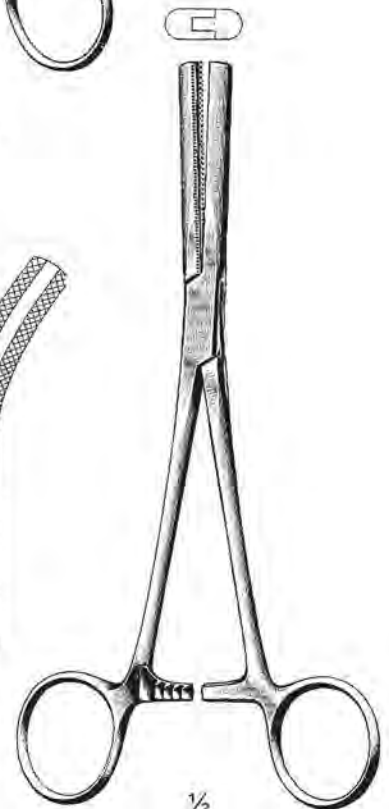

1/2  
Fergusson  
180-04-16 To 180-07-20

**Präparier- & Ligaturklemmen ; Pinzas de disección y ligaduras  
Dissecting & Ligature Forceps ; Pince dissection e legature  
Pincers à disséquer & ligatures ; Pinças dissecando e ligaduras**



Overholt  
181-01-18 To 181-05-24

$\frac{1}{4}$   
181-01-18  
18.5 cm / 7½"

$\frac{1}{4}$   
181-02-20  
20 cm / 8"

$\frac{1}{4}$   
181-03-21  
21 cm / 8¼"

$\frac{1}{4}$   
181-04-21  
21.5 cm / 8½"

$\frac{1}{4}$   
181-05-24  
24 cm / 9½"

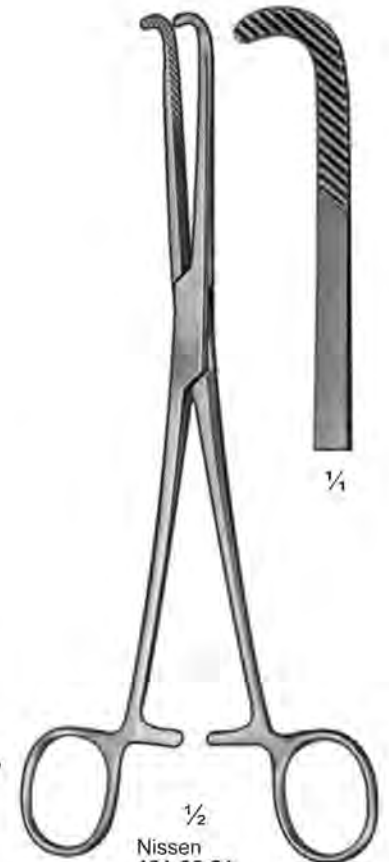

$\frac{1}{2}$   
Nissen  
181-06-21  
21.5 cm / 8½"

$\frac{1}{4}$   
181-07-18  
18 cm / 7"

$\frac{1}{4}$   
181-08-22  
22 cm / 8¾"

$\frac{1}{4}$   
181-09-25  
25 cm / 10"

$\frac{1}{4}$   
181-10-28  
28 cm / 11"



Mini-Gemini  
181-07-18 To 181-10-28

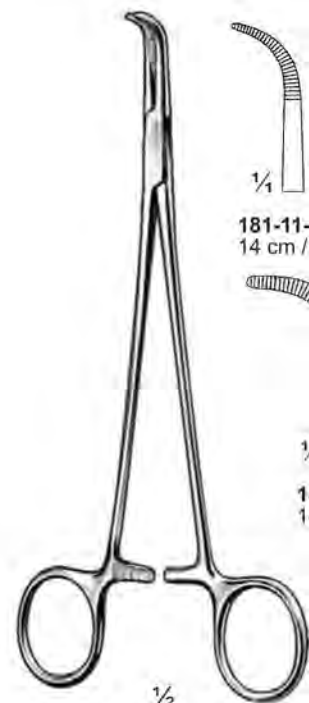

$\frac{1}{2}$   
Baby-Adson  
181-11-14 & 181-12-18

$\frac{1}{4}$   
181-11-14  
14 cm / 5½"

$\frac{1}{4}$   
181-12-18  
18 cm / 7"



Präparier- & Ligaturklemmen ; Pinzas de dissección y ligaduras  
 Dissecting & Ligature Forceps ; Pince dissezione e legature  
 Pinces à disséquer & ligatures ; Pinças dissecando e ligaduras

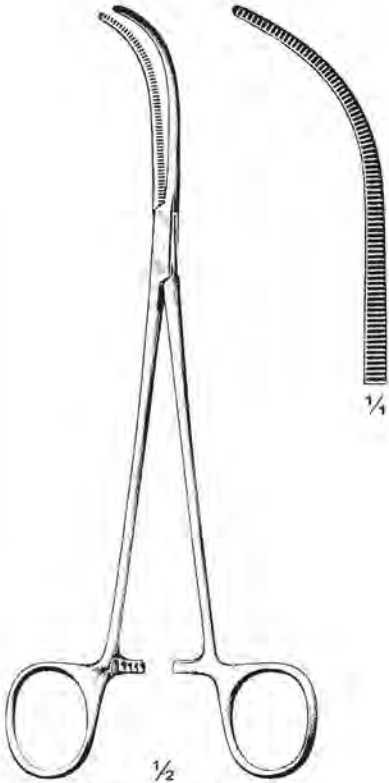

$\frac{1}{2}$   
 Overholt-Mixter  
 182-01-21  
 21 cm / 8 $\frac{1}{4}$ "

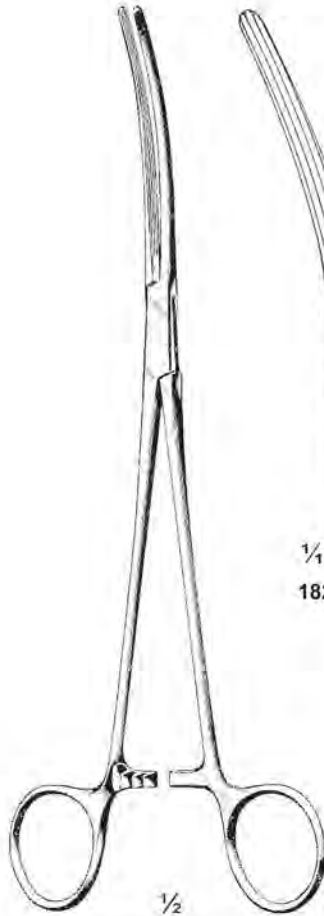

$\frac{1}{2}$   
 Crafoord-Sellors  
 182-02-24 To 182-04-24  
 24 cm / 9 $\frac{1}{2}$ "

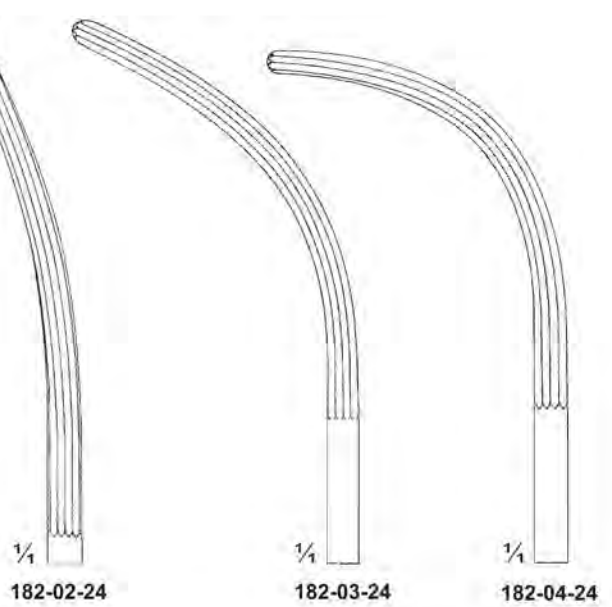

$\frac{1}{4}$   
 182-02-24

$\frac{1}{4}$   
 182-03-24

$\frac{1}{4}$   
 182-04-24

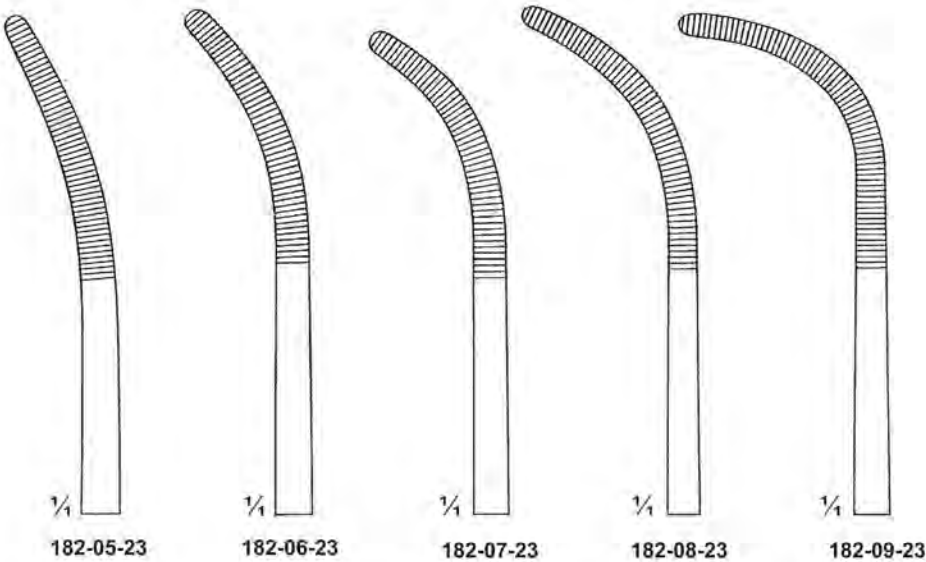

$\frac{1}{4}$   
 182-05-23

$\frac{1}{4}$   
 182-06-23

$\frac{1}{4}$   
 182-07-23

$\frac{1}{4}$   
 182-08-23

$\frac{1}{4}$   
 182-09-23



$\frac{1}{2}$   
 Rumel  
 182-05-23 To 182-09-23  
 23 cm / 9"

Präparier- & Ligaturklemmen ; Pinzas de dissección y ligaduras  
 Dissecting & Ligature Forceps ; Pince dissezione e legature  
 Pincès à disséquer & ligatures ; Pinças dissecando e ligaduras



Mixer  
 183-01-23  
 23 cm / 9"



183-02-24



Sarat  
 183-02-24 & 183-03-24  
 24 cm / 9½"



183-03-24

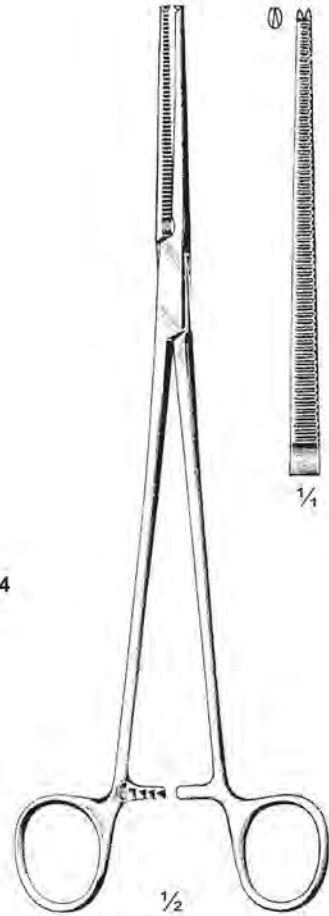

Sarat  
 183-04-24  
 24 cm / 9½"  
 1 X 2 Teeth



183-05-13  
 13 cm / 5½"



183-06-16  
 16 cm / 6¼"

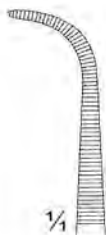

183-07-18  
 18 cm / 7"

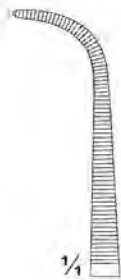

183-08-20  
 20 cm / 8"

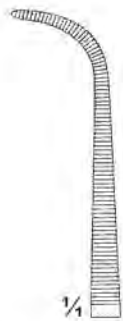

183-09-23  
 23 cm / 9"

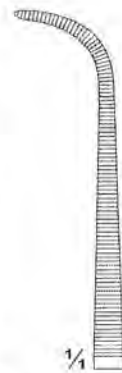

183-10-25  
 25 cm / 10"

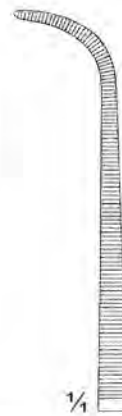

183-11-28  
 28 cm / 11"



Gemini  
 183-05-13 To 183-11-28



Präparier- & Ligaturklemmen ; Pinzas de dissección y ligaduras  
 Dissecting & Ligature Forceps ; Pince dissezione e legature  
 Pincès à disséquer & ligatures ; Pinças dissecando e ligaduras

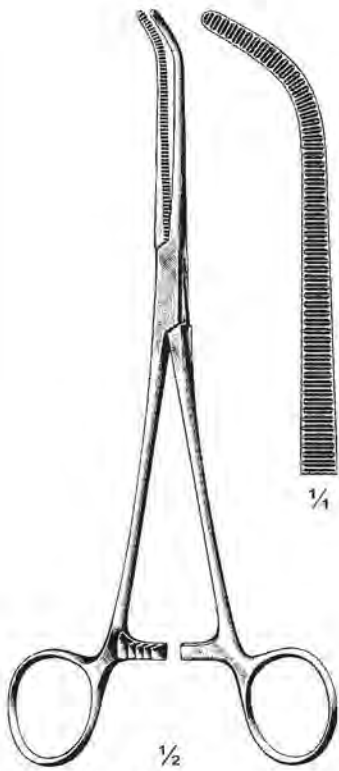

Johns-Hopkins  
 184-01-20 20 cm / 8"  
 184-02-23 23 cm / 9"  
 184-03-25 25 cm / 10"

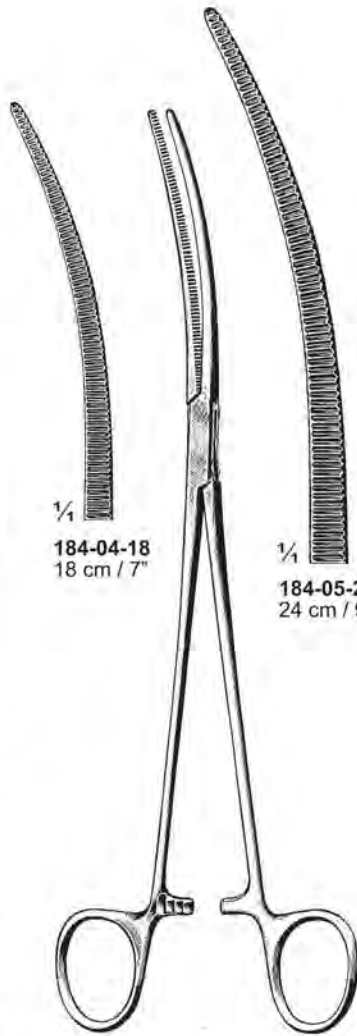

Craford  
 184-04-18 & 184-05-24

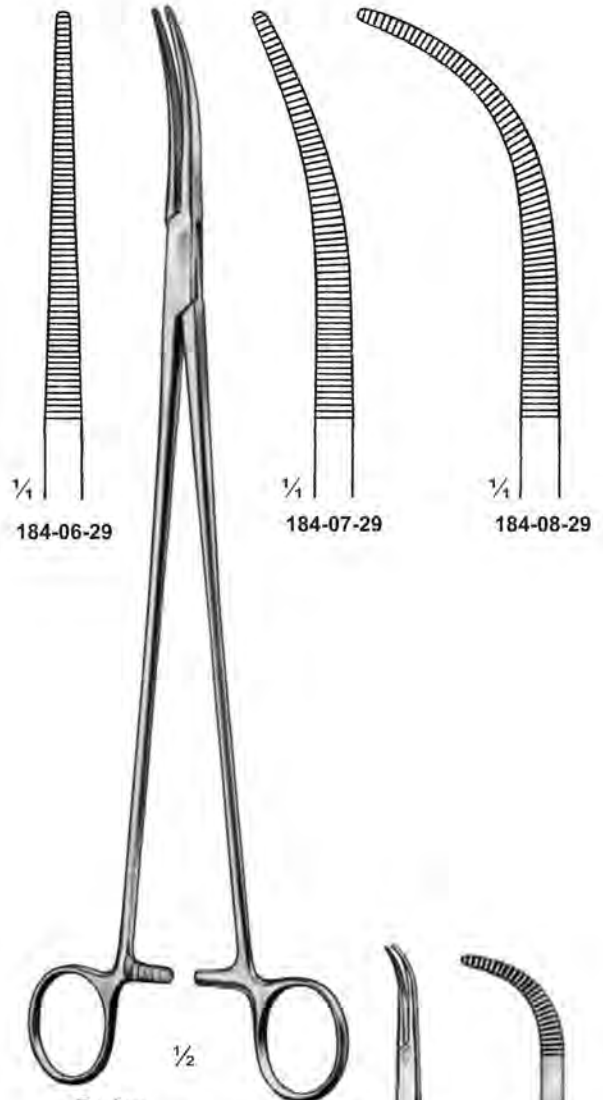

Zenker  
 184-06-29 To 184-08-29  
 29.5 cm / 11½"



Mixer-Baby  
 184-09-14 To 184-11-14  
 14 cm / 5½"



184-09-14



184-10-14



184-11-14

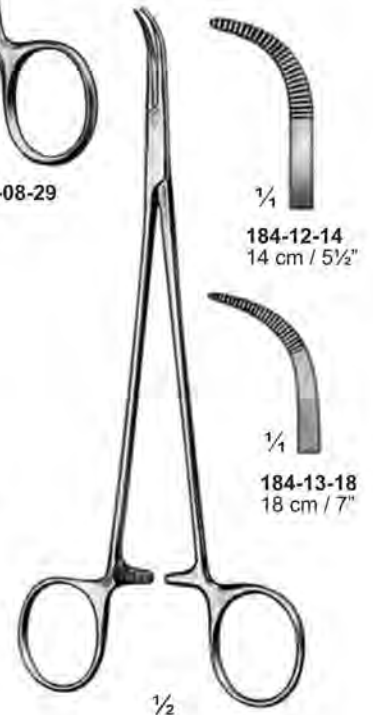

Baby-Mixer  
 184-12-14 & 184-13-18



184-12-14  
 14 cm / 5½"

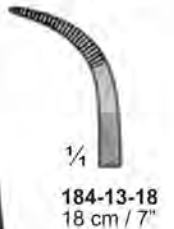

184-13-18  
 18 cm / 7"

**Präparier- & Ligaturklemmen ; Pinzas de dissección y ligaduras  
Dissecting & Ligature Forceps ; Pince dissezione e legature  
Pincas à disséquer & ligatures ; Pinças dissecando e ligaduras**

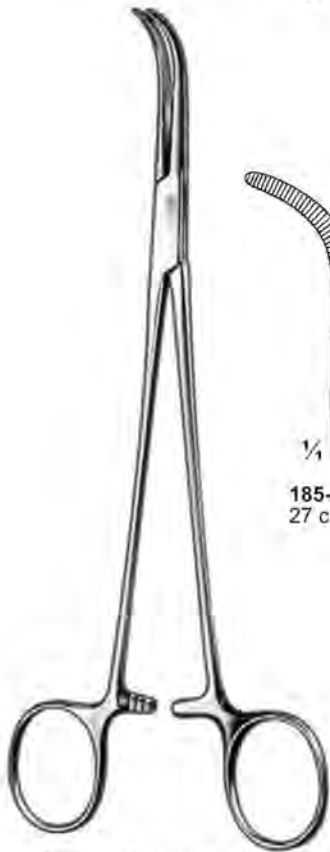
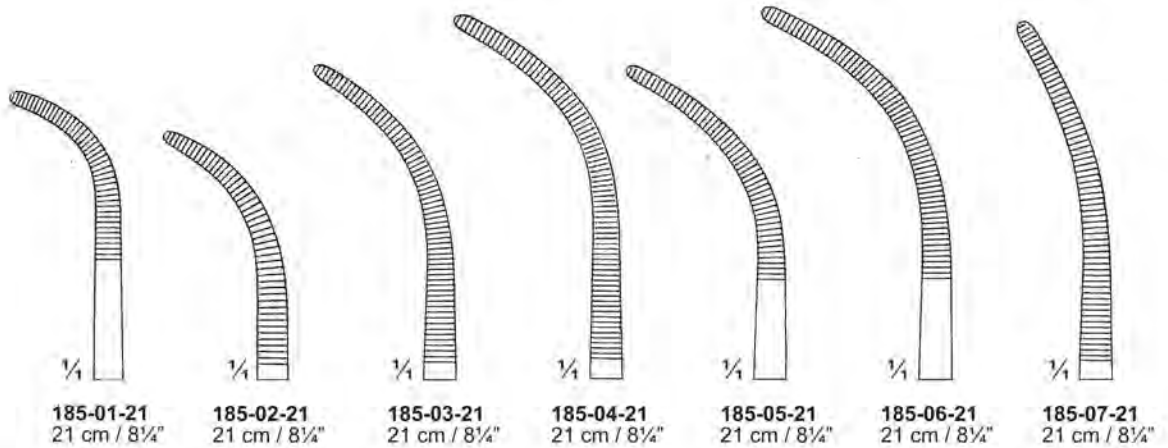

Overholt-Geissendoerfer  
185-01-21 To 185-14-27

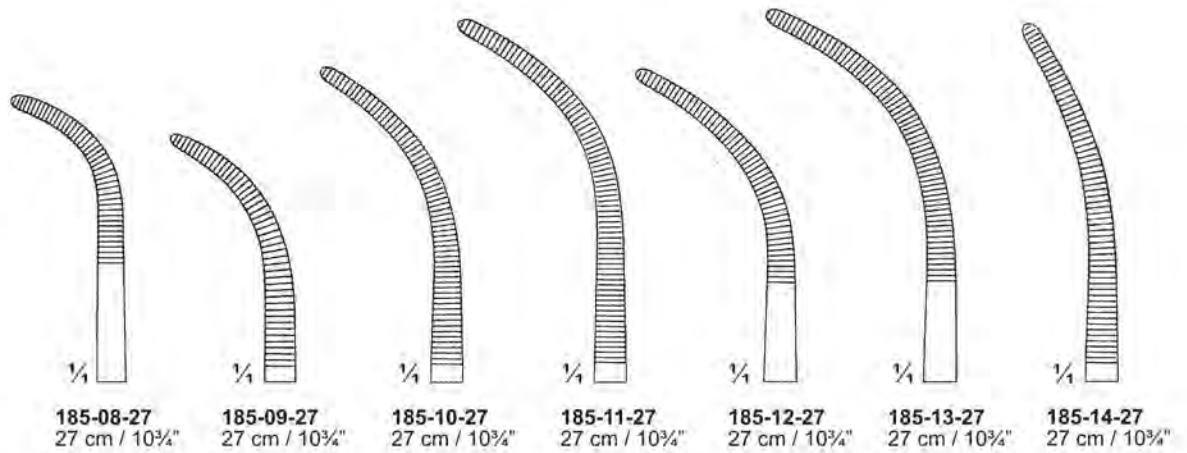

Präparier- & Ligaturklemmen ; Pinzas de dissección y ligaduras  
 Dissecting & Ligature Forceps ; Pince dissezione e legature  
 Pincers à disséquer & ligatures ; Pinças dissecando e ligaduras



Lawrence  
 186-01-27  
 27.5 cm / 10 3/4"



Kelly  
 186-02-19 To 186-10-24

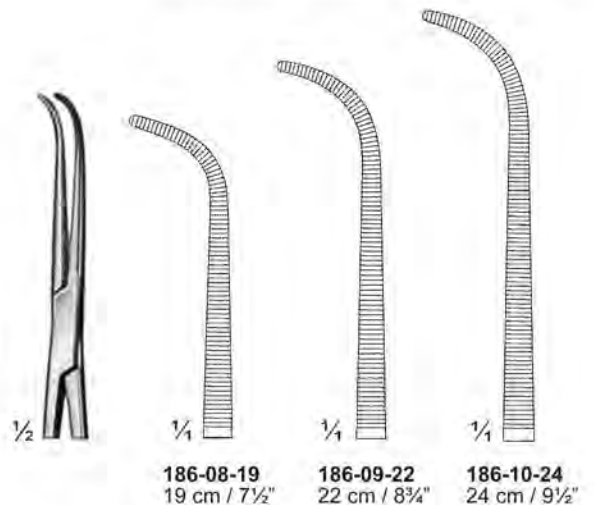
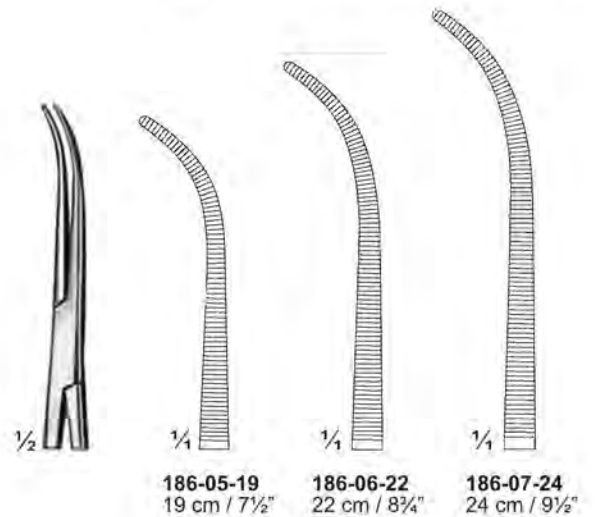
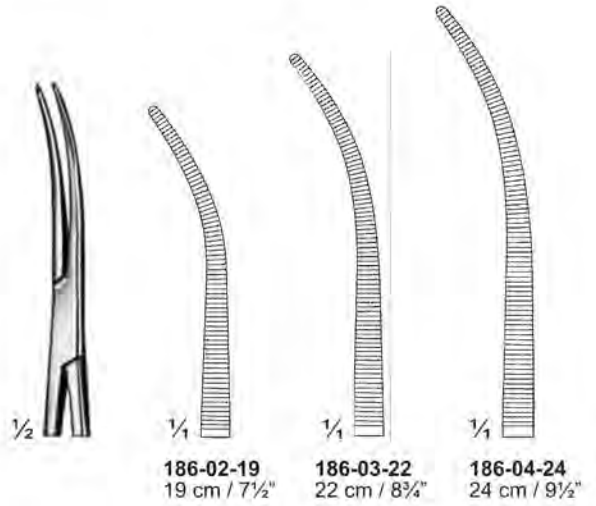

**Bronchus- und Gallengangklemmen ; Pinzas para vías biliares y bronquiales**  
**Bronchus & Gall Duct Clamp ; Pinze per vie biliari e per bronchi**  
**Pince-clamps pour voies biliaires & à bronches ; Pinças para brônquio e bÍlis**

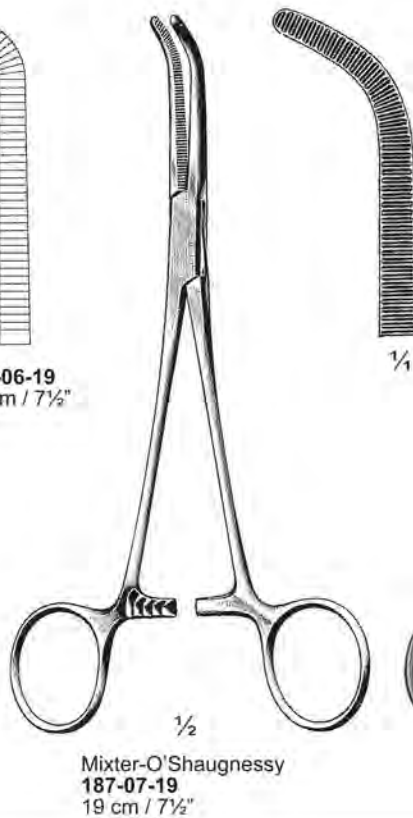
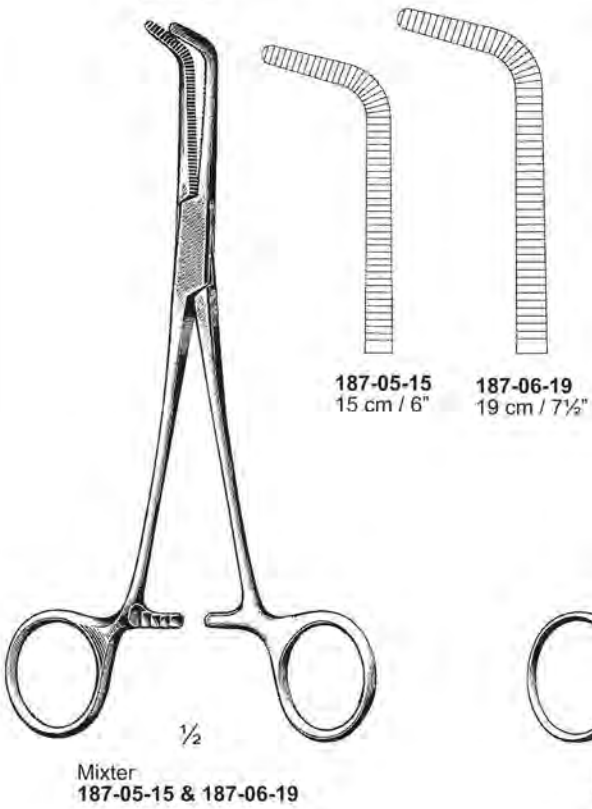
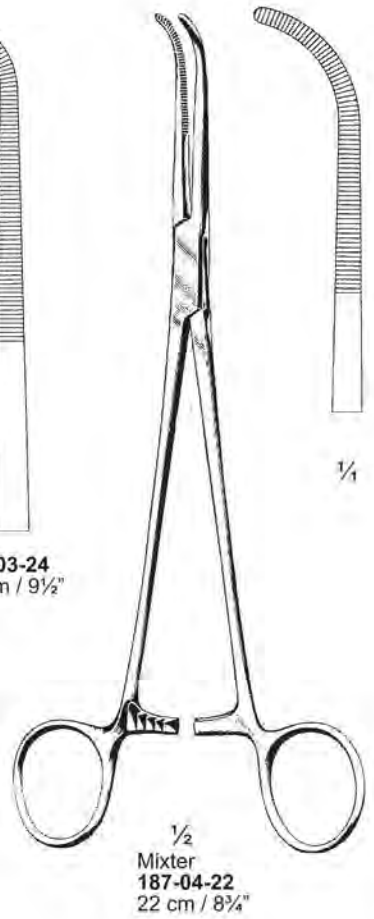
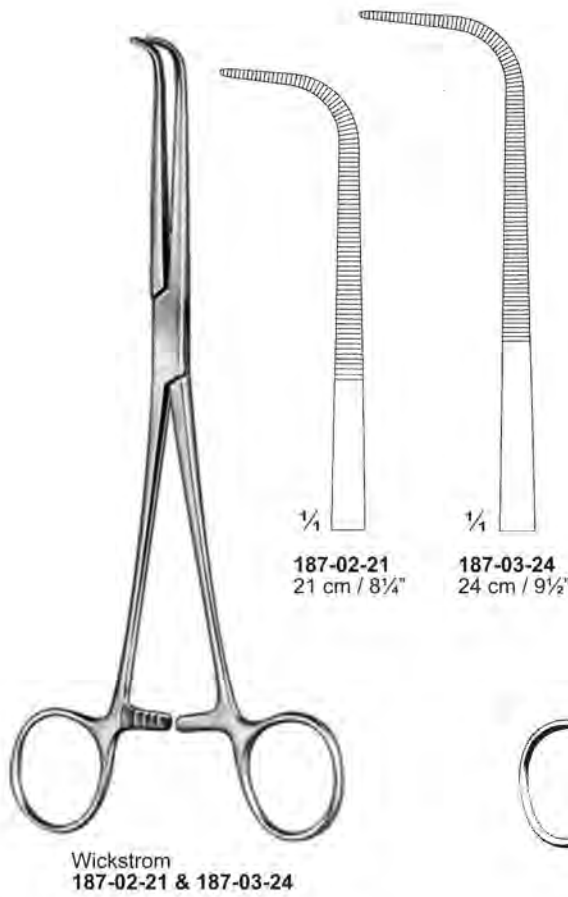
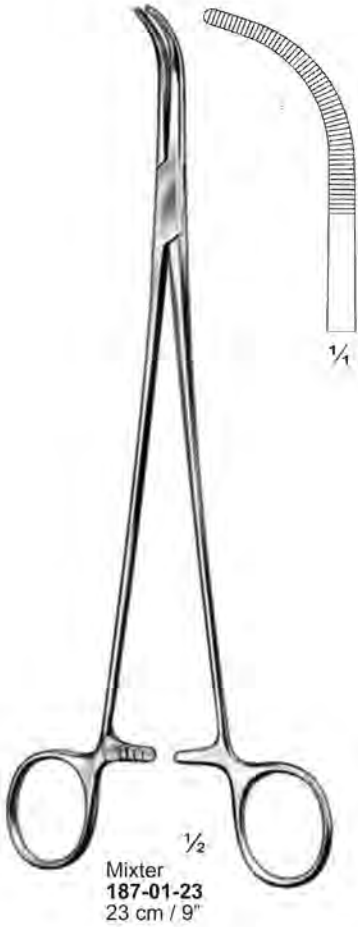

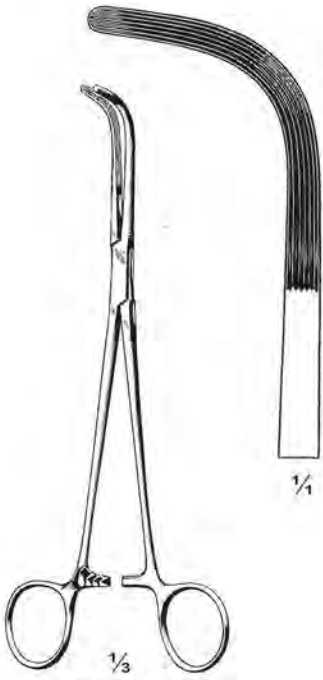

McQuigg-Mixer  
 188-01-22  
 22 cm / 8 3/4"



Finocchietto  
 188-02-24 & 188-03-24  
 24 cm / 9 1/2"



188-03-24

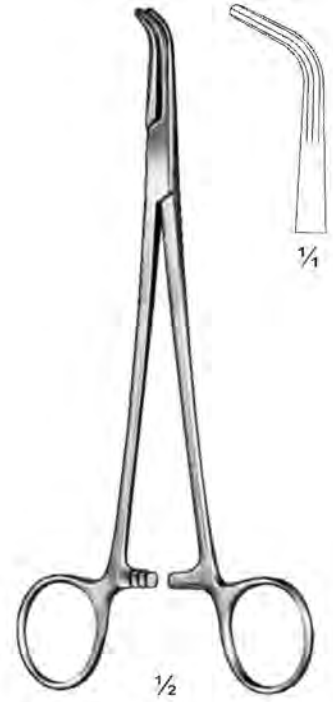

Lower  
 188-04-18  
 18 cm / 7"

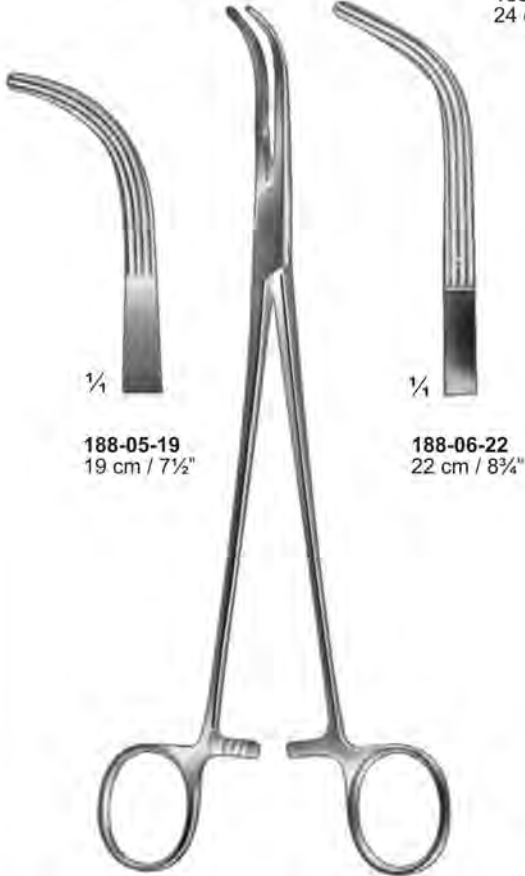

188-05-19  
 19 cm / 7 1/2"

188-06-22  
 22 cm / 8 3/4"

Lahey (Sweet)  
 188-05-19 & 188-06-22



188-07-19  
 19 cm / 7 1/2"

188-08-23  
 23 cm / 9"

Lahey  
 188-07-19 & 188-08-23

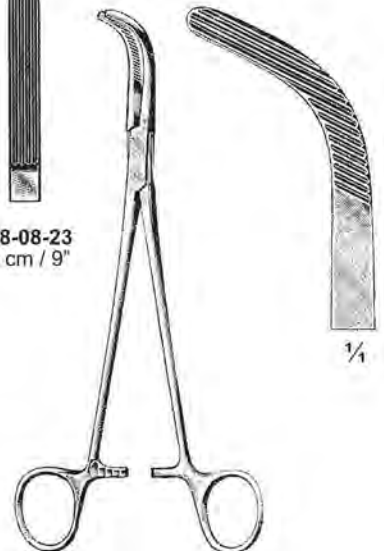

Crile-Mixer  
 188-09-18  
 18 cm / 7"



**Bronchus- und Gallengangklemmen ; Pinzas para vías biliares y bronquiales  
Bronchus & Gall Duct Clamp ; Pinze per vie biliari e per bronchi  
Pince-clamps pour voies biliaires & à bronches ; Pinças para brônquio e bÍlis**



Mixer  
189-01-22 To 189-03-28

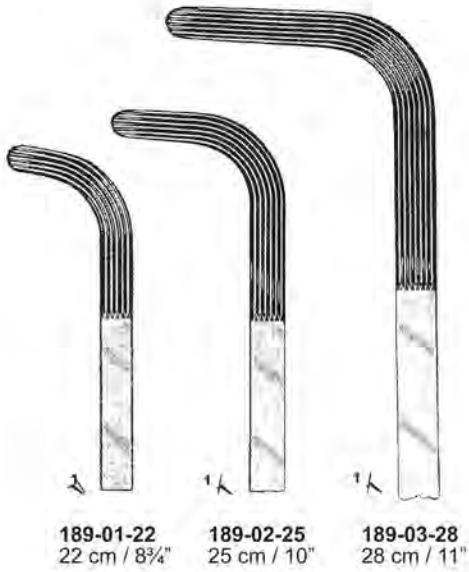

189-01-22  
22 cm / 8 3/4"

189-02-25  
25 cm / 10"

189-03-28  
28 cm / 11"

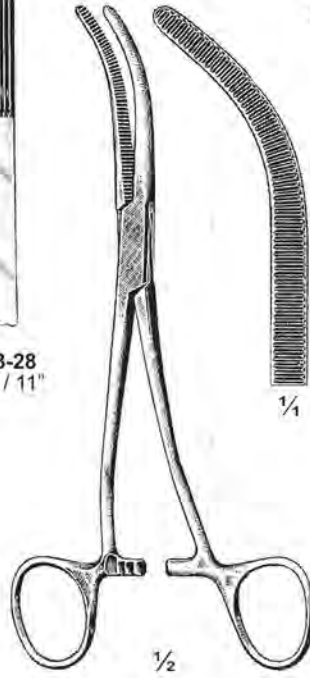

Dean-Shallcross  
189-04-18  
18 cm / 7"



1/4



Desjardins  
189-05-22  
22 cm / 8 3/4"

1/4

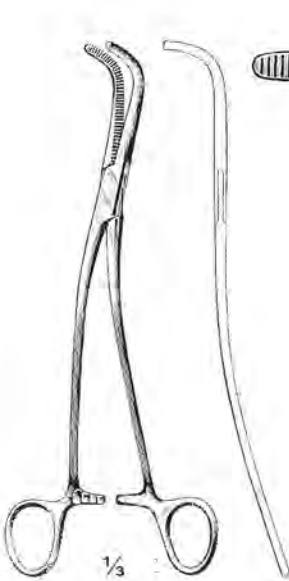

Gray  
189-06-22 To 189-09-23

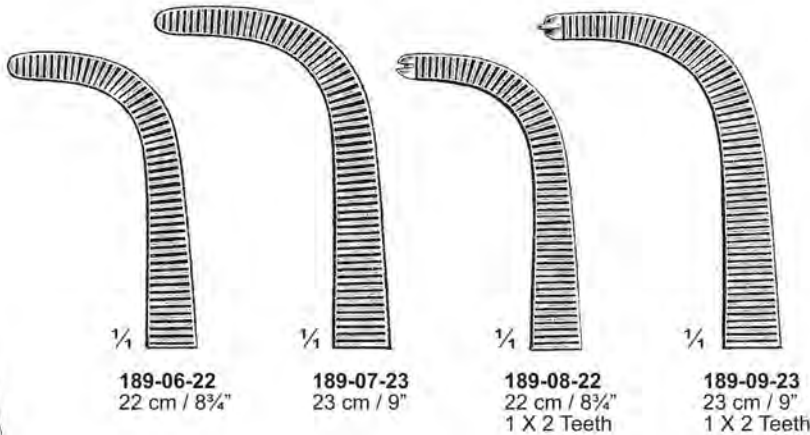

189-06-22  
22 cm / 8 3/4"

189-07-23  
23 cm / 9"

189-08-22  
22 cm / 8 3/4"  
1 X 2 Teeth

189-09-23  
23 cm / 9"  
1 X 2 Teeth

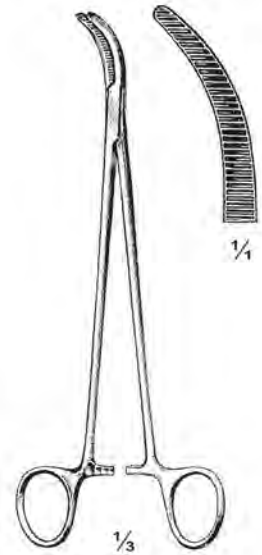

Desjardins  
189-10-21  
21 cm / 8 1/4"

1/4



Nierenstielklemmen ; Pinzas clamps de pediculos renales  
 Kidney Pedicle Clamps ; Morsetti di peduncoli renali  
 Pince-clamps pour pédicules rénaux ; Grampos para pedículos renais



Guyon  
 190-01-19 To 190-04-26



$\frac{1}{4}$   
 190-01-19  
 19.5 cm / 7 $\frac{3}{4}$ "



$\frac{1}{4}$   
 190-02-22  
 22 cm / 8 $\frac{3}{4}$ "



$\frac{1}{4}$   
 190-03-23  
 23 cm / 9"



$\frac{1}{4}$   
 190-04-26  
 26.5 cm / 10 $\frac{1}{4}$ "



190-05-24  
 24 cm / 9 $\frac{1}{2}$ "

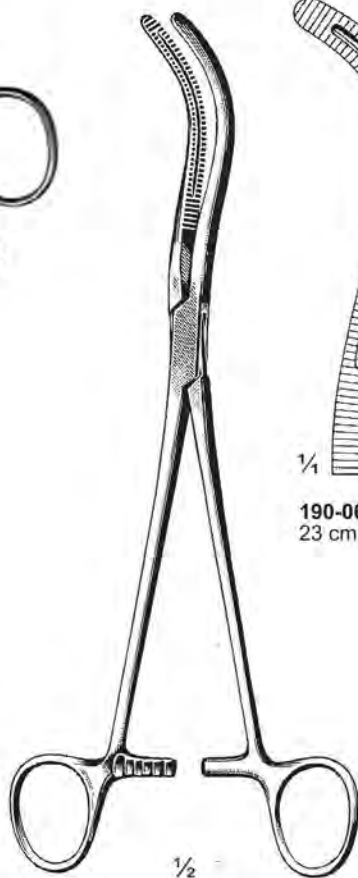

Stille  
 190-05-23 To 190-07-24



$\frac{1}{4}$   
 190-06-23  
 23 cm / 9"



$\frac{1}{4}$   
 190-07-24  
 24 cm / 9 $\frac{1}{2}$ "

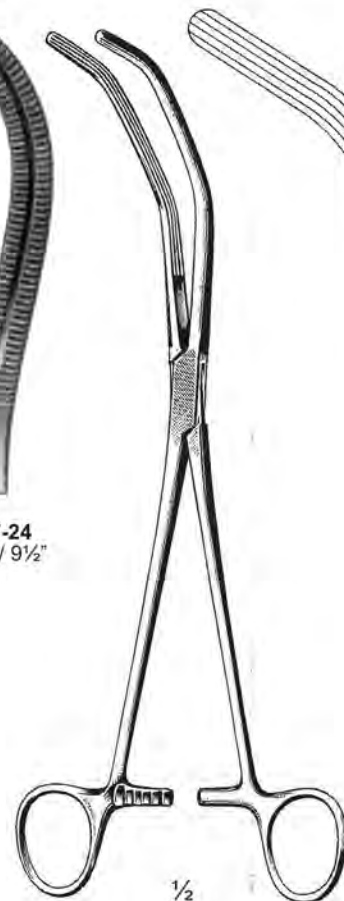

Herrick  
 190-08-23  
 23 cm / 9"

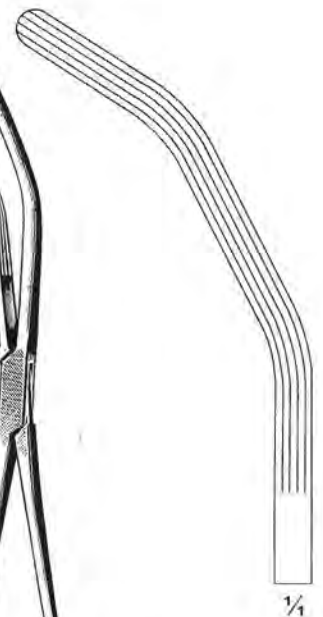

$\frac{1}{4}$

Nierenstielklemmen ; Pinzas clamps de pedículos renales  
 Kidney Pedicle Clamps ; Morsetti di peduncoli renali  
 Pince-clamps pour pédicules rénaux ; Grampos para pedículos renais

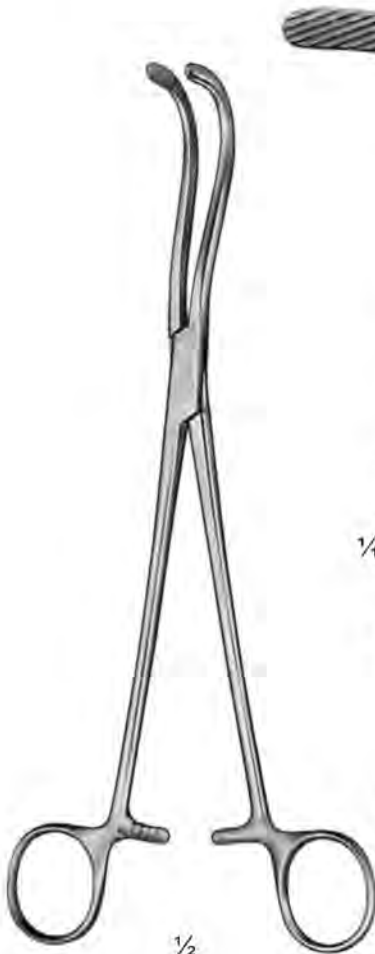

$\frac{1}{2}$   
 Guyon  
 191-01-23  
 23.5 cm / 9 $\frac{1}{4}$ "

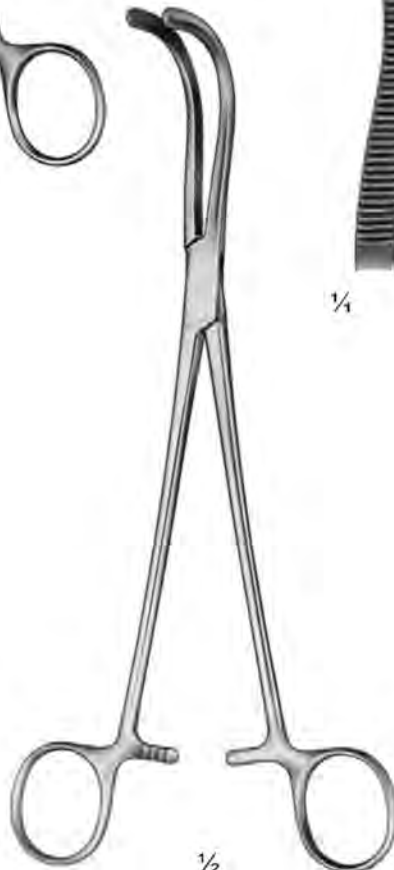

$\frac{1}{2}$   
 Guyon  
 191-02-23  
 23 cm / 9"

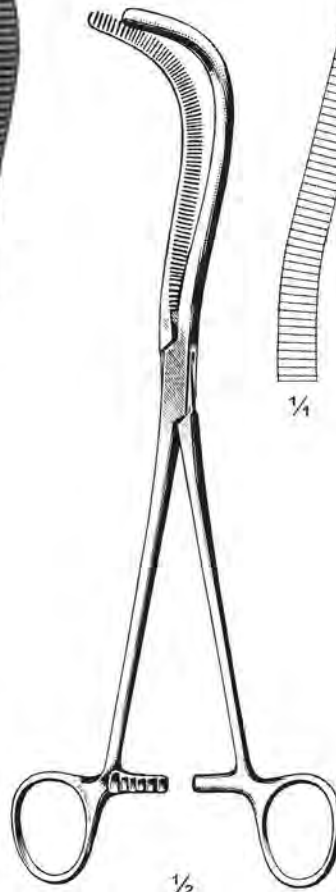

$\frac{1}{2}$   
 Mayo-Guyon  
 191-03-23  
 23 cm / 9"

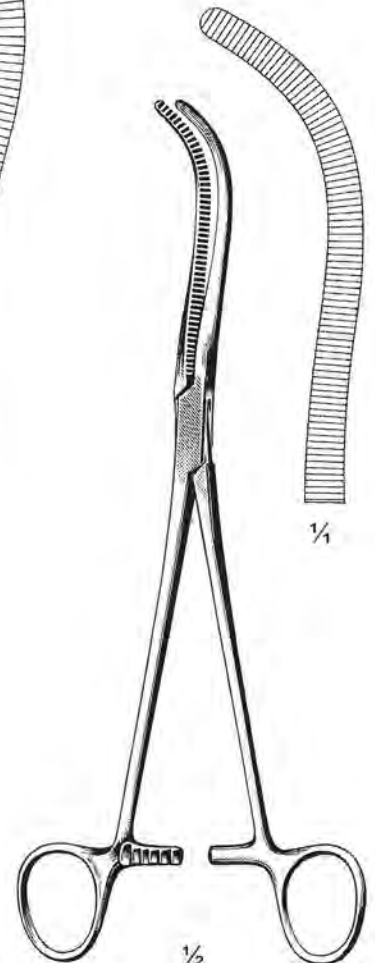

$\frac{1}{2}$   
 Mayo  
 191-04-23  
 23 cm / 9"



Hysterektomieklemmen ; Pinzas para histerectomía  
 Hysterectomy Clamps ; Pinze per isterectomia  
 Clamps à hystérectomie ; Pinças para histerectomia

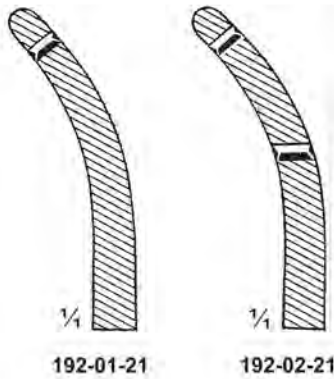

Heaney  
 192-01-21 & 192-02-21  
 21 cm / 8 1/4"

Heaney-Rezek  
 192-03-21  
 21 cm / 8 1/4"

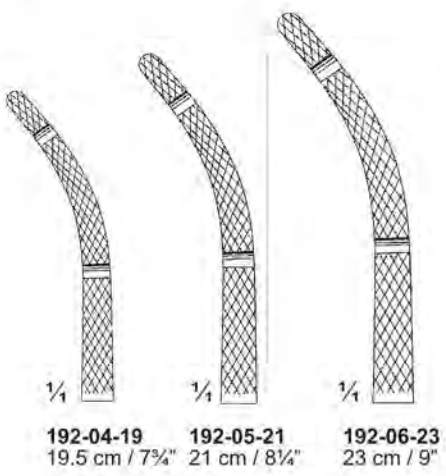

Heaney  
 192-04-19 To 192-06-23

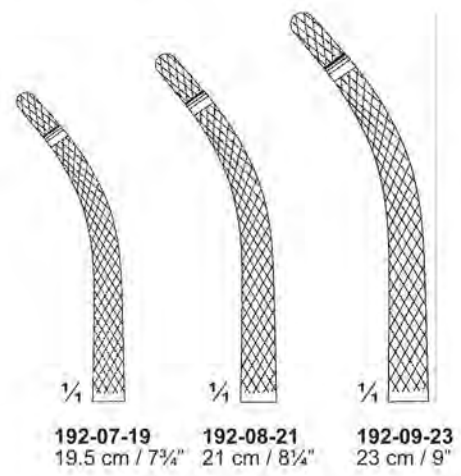
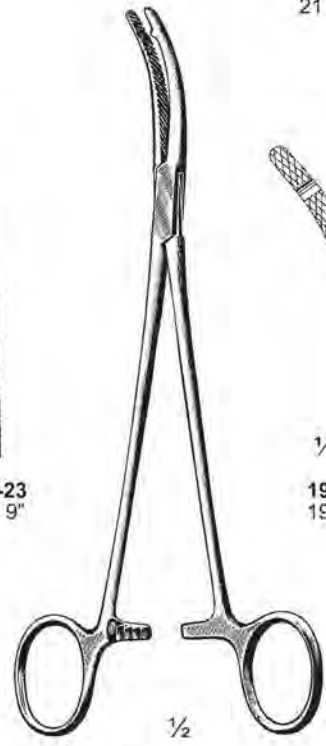

Heaney  
 192-07-19 To 192-09-23

Hysterektomieklemmen ; Pinzas para histerectomia  
 Hysterectomy Clamps ; Pinze per isterectomia  
 Clamps à hystérectomie ; Pinças para histerectomia



Walzl  
 193-01-19  
 19 cm / 7 1/2"



Ballentine  
 193-02-21  
 21 cm / 8 1/4"



Heaney-Ballentine  
 193-03-21  
 21 cm / 8 1/4"

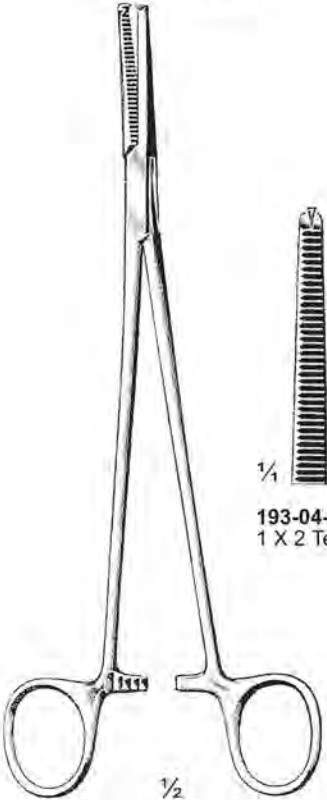

Phaneuf  
 193-04-21 To 193-06-21  
 21.5 cm / 8 1/2"



193-04-21  
 1 X 2 Teeth



193-05-21  
 1 X 2 Teeth



193-06-21  
 1 X 2 Teeth

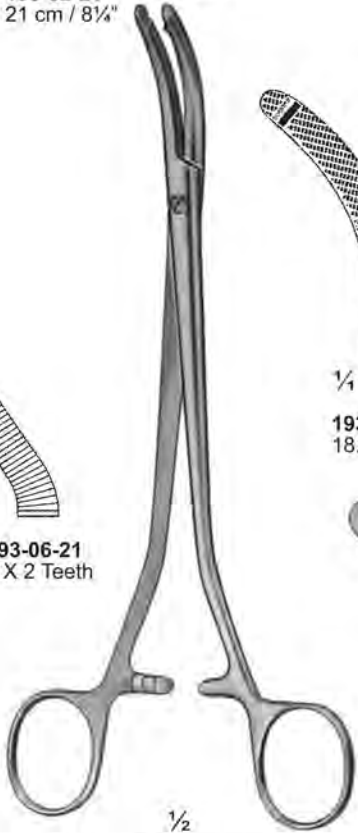

Wiener Model  
 193-07-18 To 193-11-24



193-07-18  
 18.5 cm / 7 1/4"



193-08-22  
 22 cm / 8 3/4"



193-09-25  
 25 cm / 10"



193-10-22  
 22 cm / 8 3/4"



193-11-24  
 24 cm / 9 1/2"



**Hysterektomieklemmen ; Pinzas para histerectomia  
Hysterectomy Clamps ; Pinze per isterectomia  
Clamps à hystérectomie ; Pinças para histerectomia**

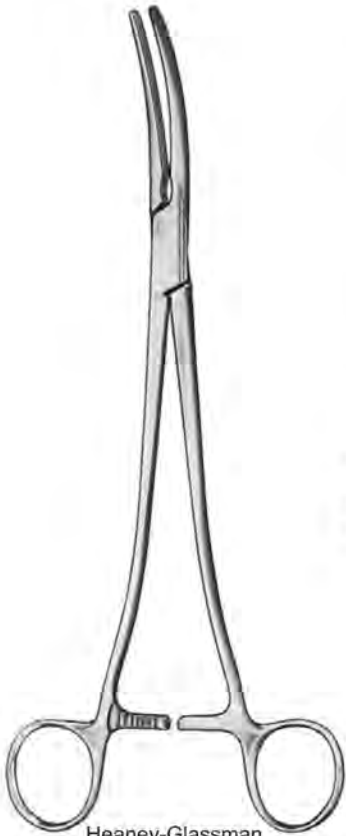

Heaney-Glassman  
194-01-22 To 194-04-20



194-01-22  
22 cm / 8 3/4"



194-02-22  
22 cm / 8 3/4"

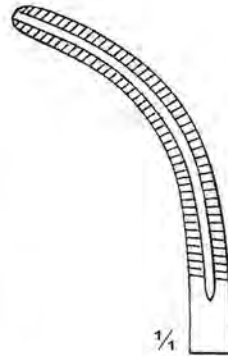

194-03-22  
22 cm / 8 3/4"

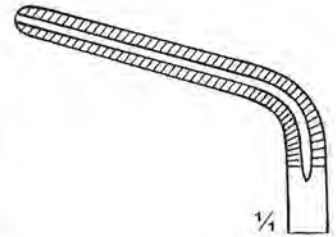

194-04-20  
20 cm / 8"



Long  
194-05-19  
19 cm / 7 1/2"  
1 X 2 Teeth



194-06-20  
20 cm / 8"



194-07-25  
25 cm / 10"

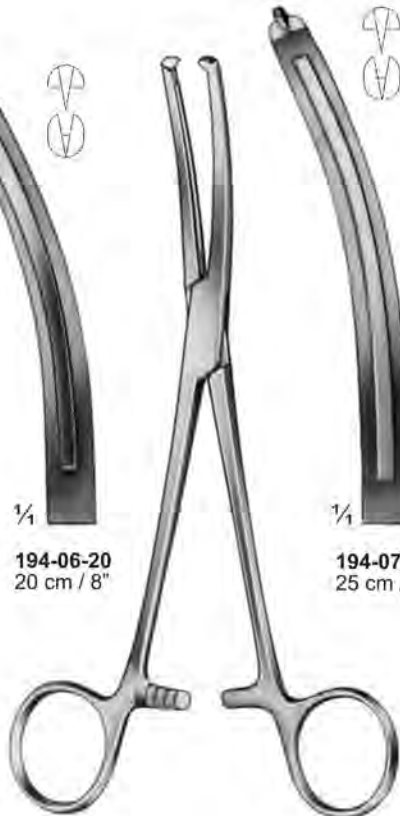

Maingot  
194-06-20 & 194-07-25  
1 X 2 Teeth

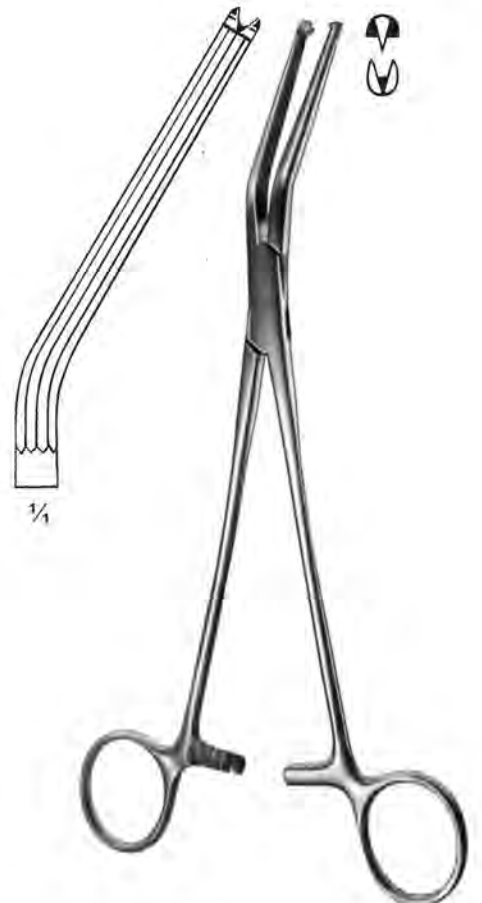

Kuffler  
194-08-23  
23 cm / 9"  
1 X 2 Teeth



**Hysterektomieklemmen ; Pinzas para histerectomia  
Hysterectomy Clamps ; Pinze per isterectomia  
Clamps à hystérectomie ; Pinças para histerectomia**

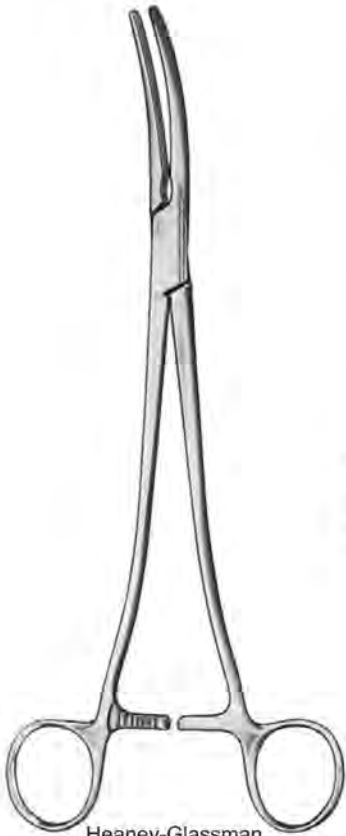

Heaney-Glassman  
194-01-22 To 194-04-20



194-01-22  
22 cm / 8 3/4"



194-02-22  
22 cm / 8 3/4"

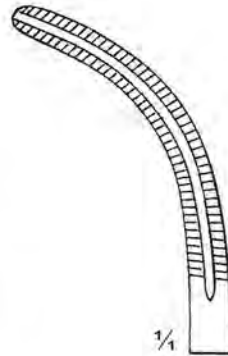

194-03-22  
22 cm / 8 3/4"

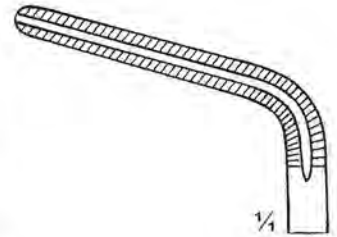

194-04-20  
20 cm / 8"



Long  
194-05-19  
19 cm / 7 1/2"  
1 X 2 Teeth



194-06-20  
20 cm / 8"



194-07-25  
25 cm / 10"



Maingot  
194-06-20 & 194-07-25  
1 X 2 Teeth

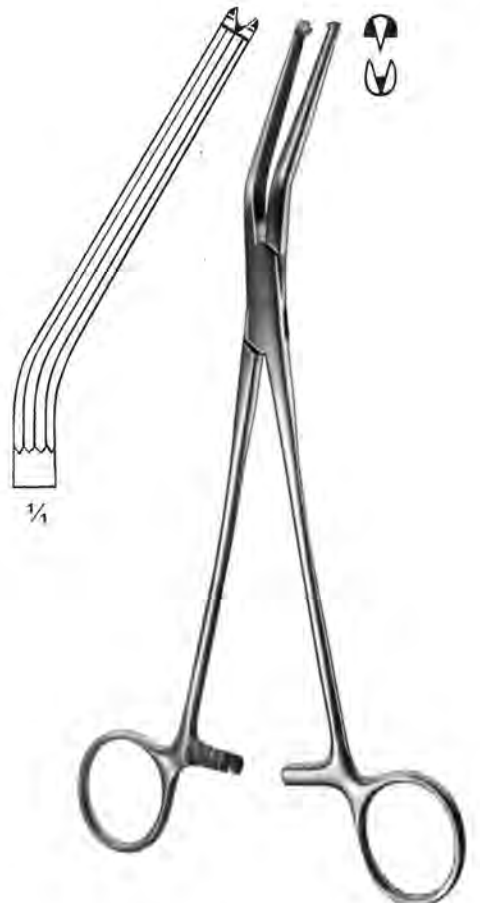

Kuffler  
194-08-23  
23 cm / 9"  
1 X 2 Teeth

**Hysterektomieklemmen ; Pinzas para histerectomía  
 Hysterectomy Clamps ; Pinze per isterectomia  
 Clamps à hystérectomie ; Pinças para histerectomia**

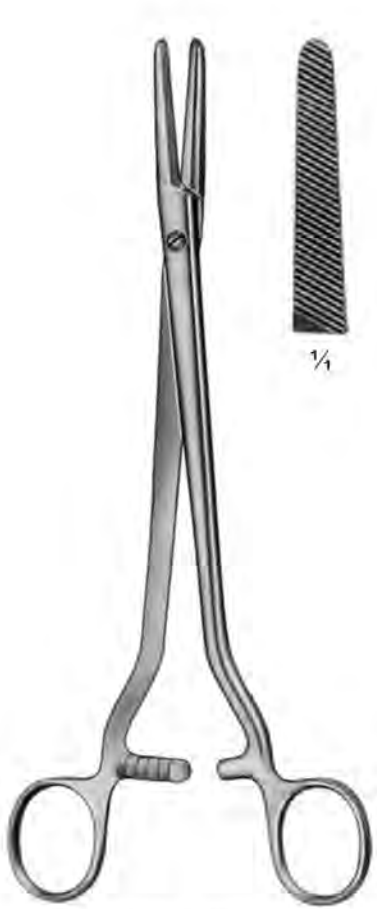

Segond-Landau  
 196-01-24  
 24 cm / 9½"

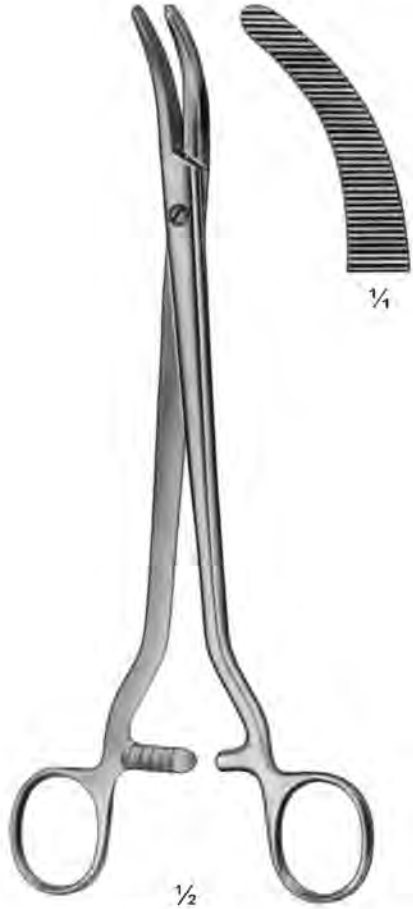

Segond  
 196-02-24  
 24 cm / 9½"

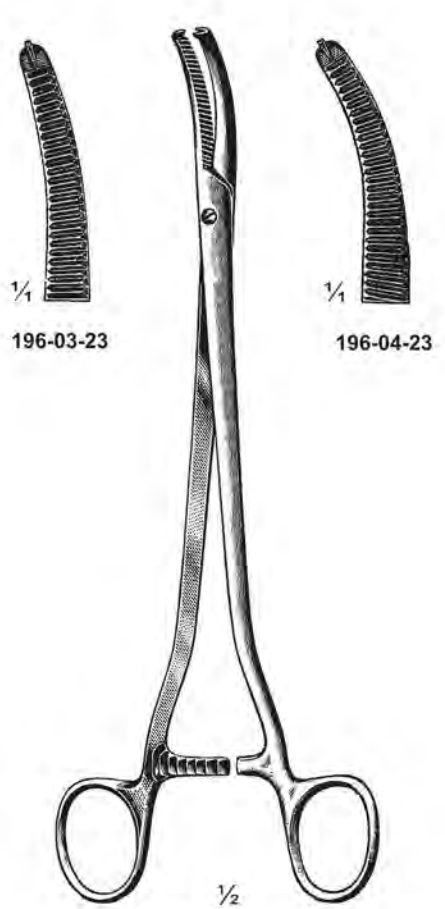

Wertheim  
 196-03-23 & 196-04-23  
 23.5 cm / 9¼"  
 1 X 2 Teeth



**Hysterektomieklemmen ; Pinzas para histerectomía  
Hysterectomy Clamps ; Pinze per isterectomia  
Clamps à hystérectomie ; Pinças para histerectomia**

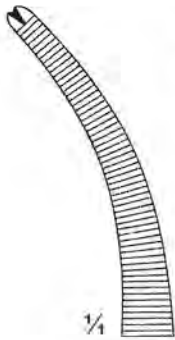

1/4  
197-01-23

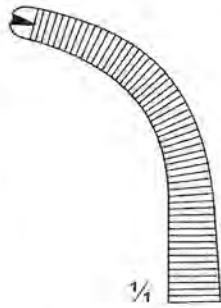

1/4  
197-02-23

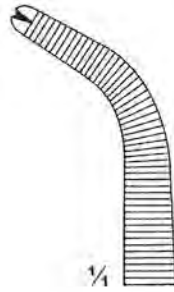

1/4  
197-03-23



1/2  
Wertheim  
197-01-23 To 197-03-23  
23 cm / 9"  
1 X 2 Teeth



1/4



1/4

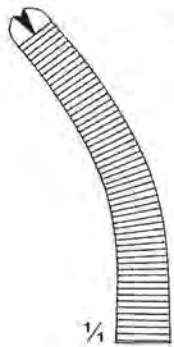

1/4

Extra strong

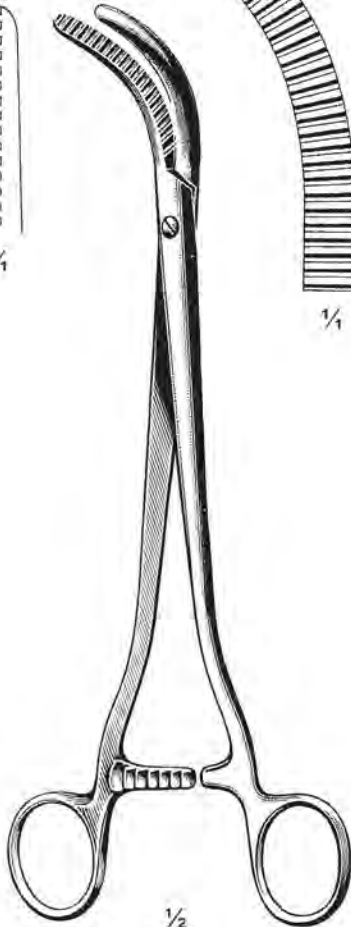

1/2  
Wertheim  
197-04-25  
25 cm / 10"

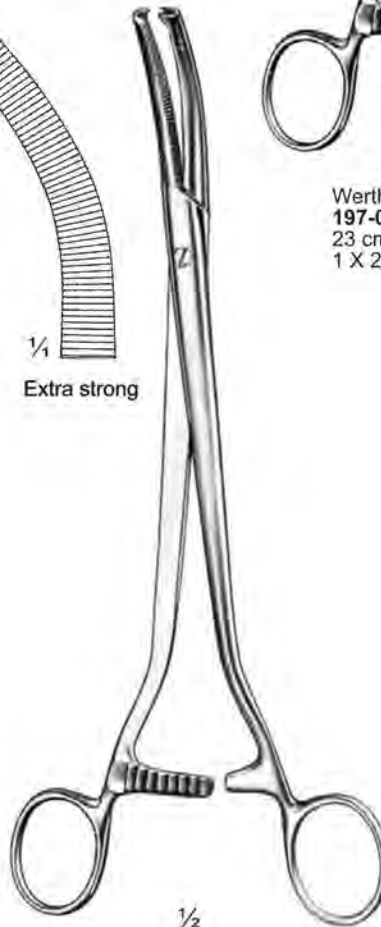

1/2  
Wertheim  
197-05-24  
24 cm / 9 1/2"  
1 x 2 Teeth

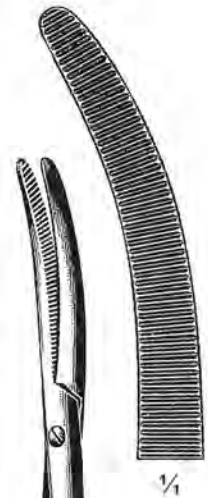

1/4

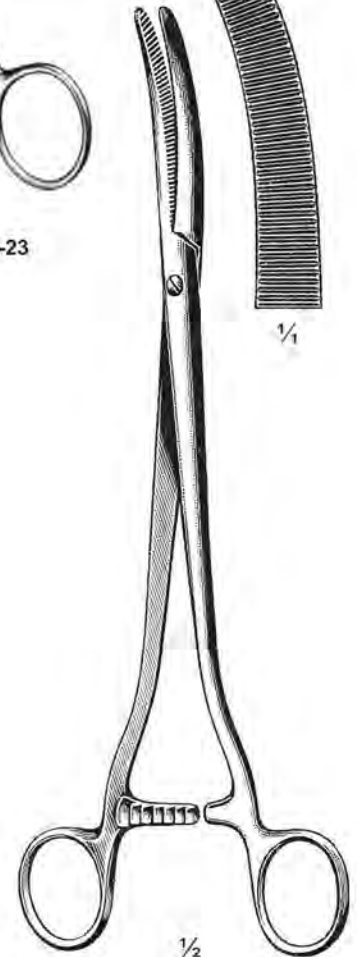

1/2  
Faure  
197-06-25  
25 cm / 10"

Hysterektomieklemmen ; Pinzas para histerectomía  
 Hysterectomy Clamps ; Pinze per isterectomia  
 Clamps à hystérectomie ; Pinças para histerectomia



Ethridge  
 198-01-22 22 cm / 8 3/4" Str  
 198-02-22 22 cm / 8 3/4" Cur



Wertheim  
 198-03-18  
 18 cm / 7"



Wertheim  
 198-04-18  
 18.5 cm / 7 1/4"

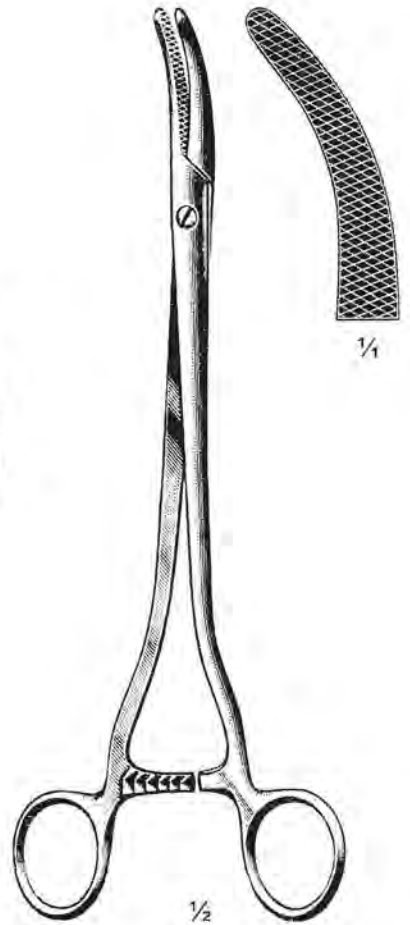

Wertheim  
 198-05-25  
 25 cm / 10"

Hysterektomieklemmen ; Pinzas para histerectomía  
 Hysterectomy Clamps ; Pinze per isterectomia  
 Clamps à hystérectomie ; Pinças para histerectomia

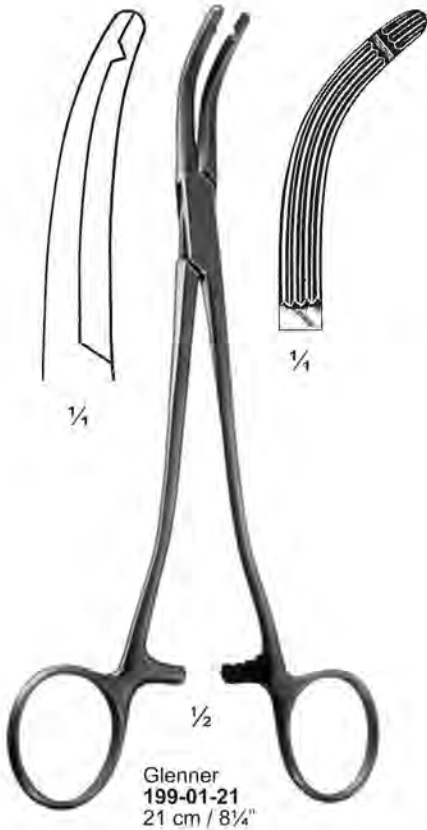

Glenner  
 199-01-21  
 21 cm / 8 1/4"

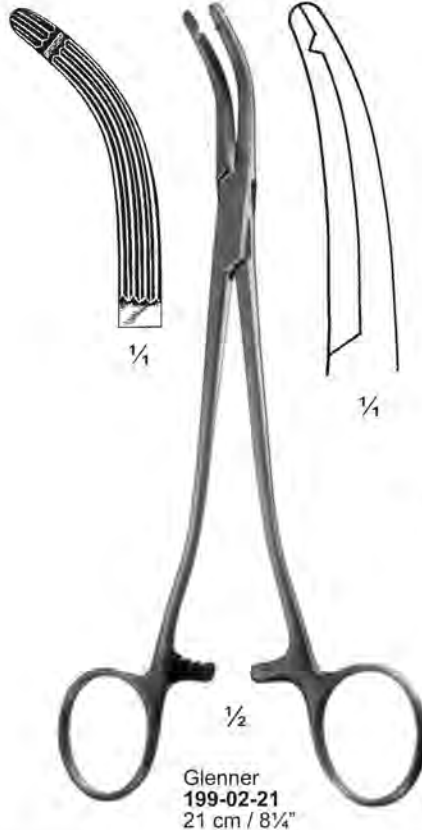

Glenner  
 199-02-21  
 21 cm / 8 1/4"

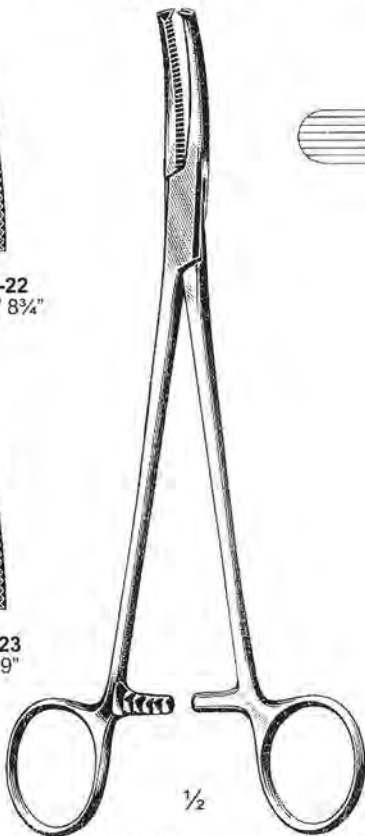

Wertheim  
 199-03-22 & 199-04-23  
 1 X 2 Teeth

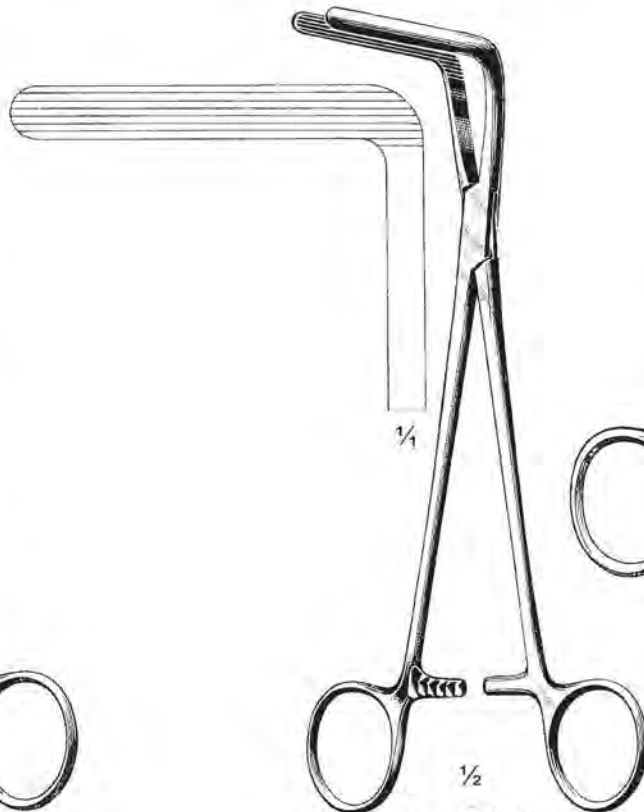

Wertheim-Cullen  
 199-05-21  
 21.5 cm / 8 1/2"

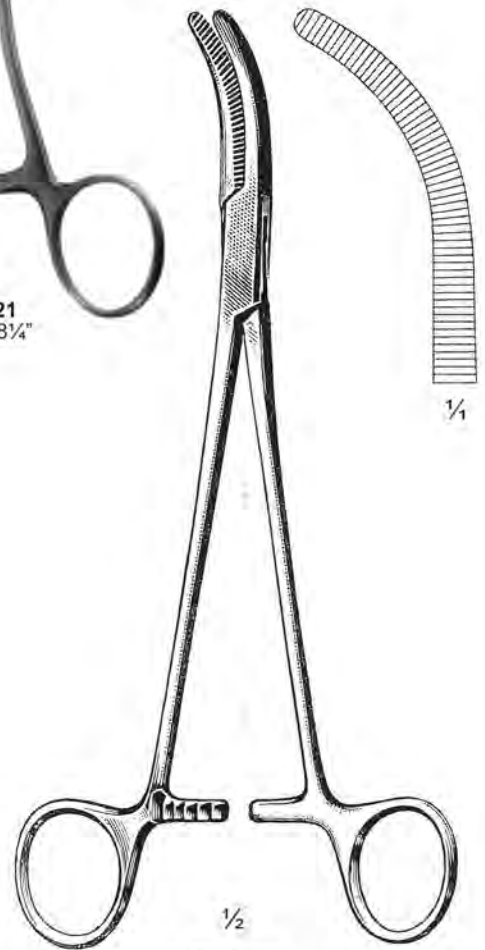

Wertheim  
 199-06-25  
 25 cm / 10"



Hysterektomieklemmen ; Pinzas para histerectomía  
 Hysterectomy Clamps ; Pinze per isterectomia  
 Clamps à hystérectomie ; Pinças para histerectomia

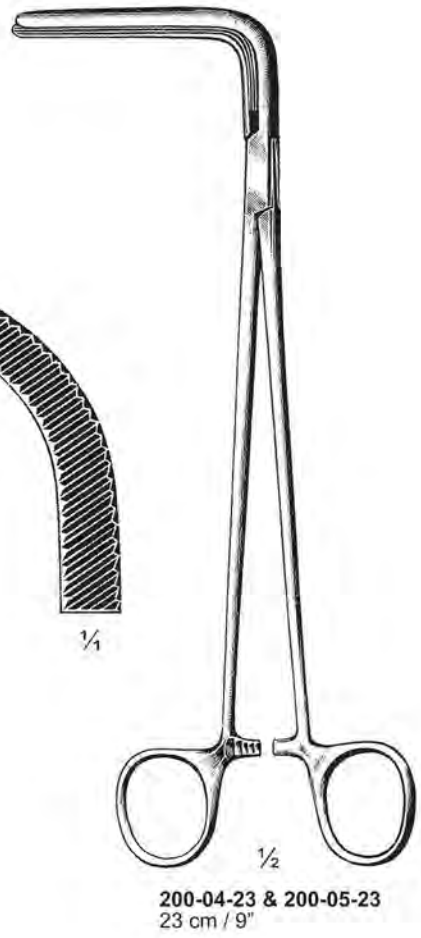
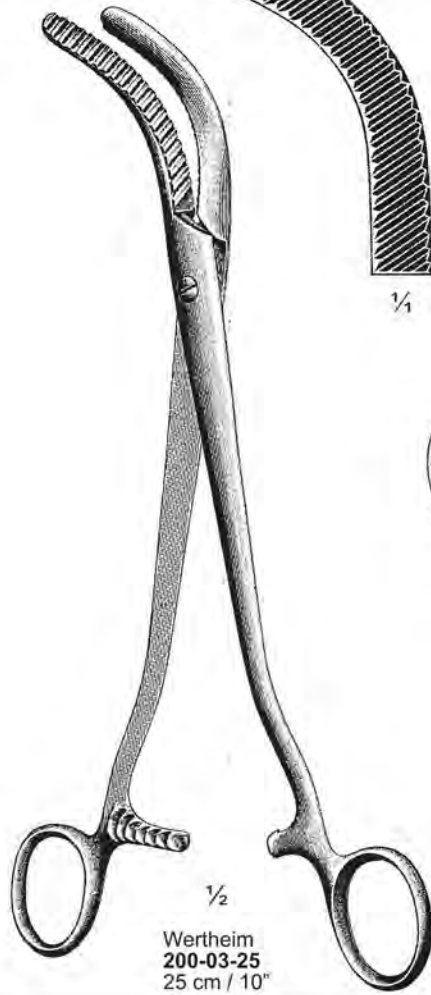
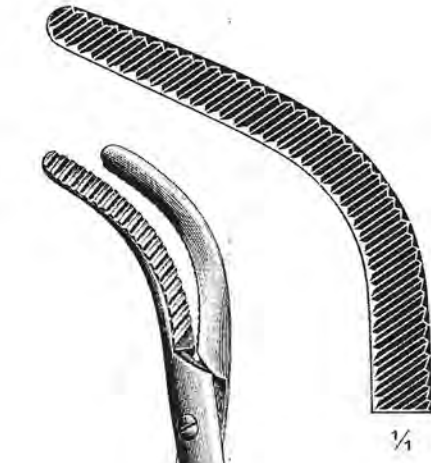
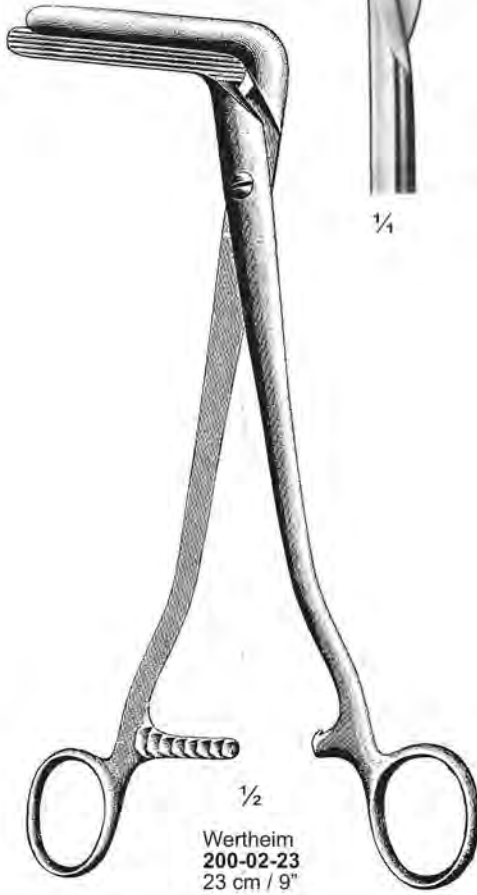
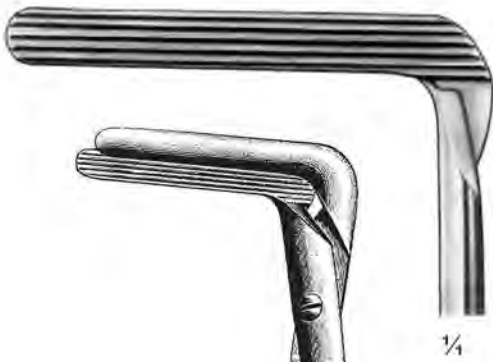
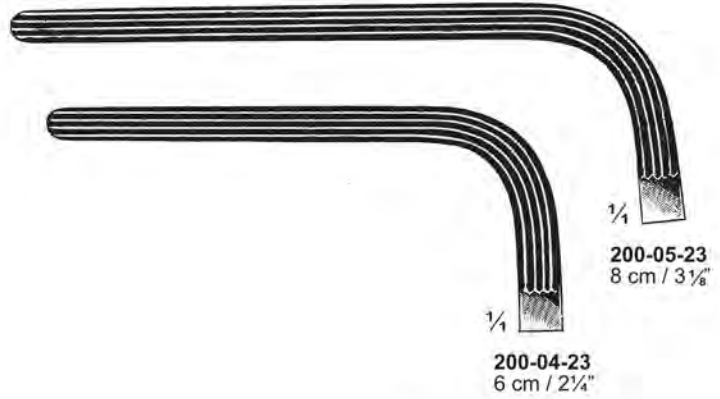
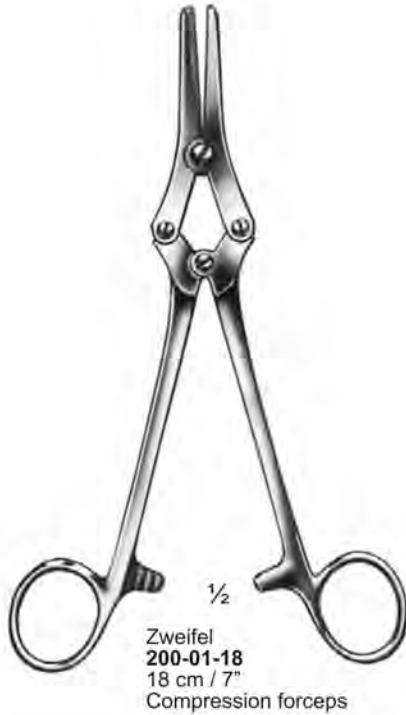

Hysterektomieklemmen ; Pinzas para histerectomía  
 Hysterectomy Clamps ; Pinze per isterectomia  
 Clamps à hystérectomie ; Pinças para histerectomia

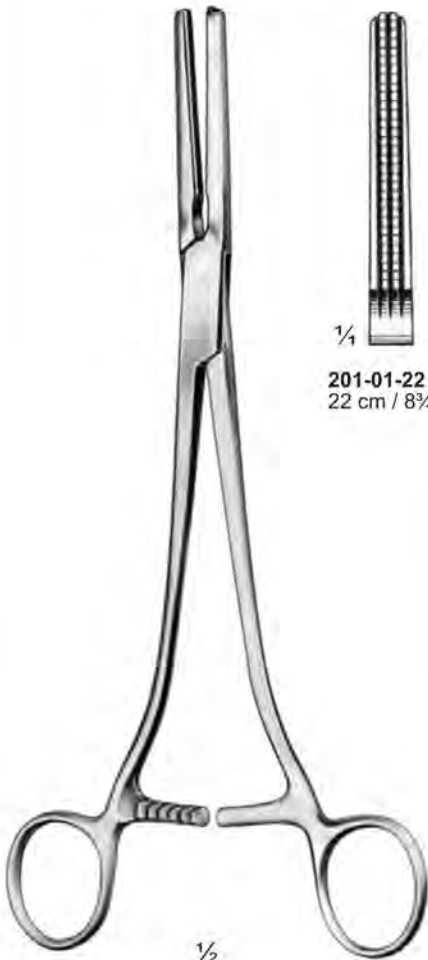

1/2  
 Rogers  
 201-01-22 To 201-09-23



1/4  
 201-01-22  
 22 cm / 8 3/4"



1/4  
 201-02-21  
 21.5 cm / 8 1/2"



1/4  
 201-03-21  
 21 cm / 8 1/4"

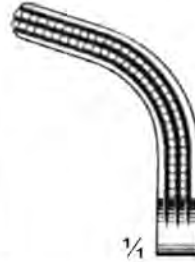

1/4  
 201-04-20  
 20 cm / 8"



1/4  
 201-05-20  
 20 cm / 8"

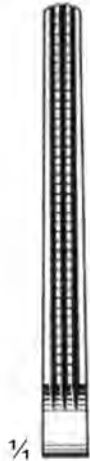

1/4  
 201-06-25  
 25 cm / 10"



1/4  
 201-07-25  
 25 cm / 10"



1/4  
 201-08-24  
 24.5 cm / 9 3/4"



1/4  
 201-09-23  
 23 cm / 9"



1/4  
 201-10-23  
 23 cm / 9"

1/4  
 201-11-24  
 24 cm / 9 1/2"



1/4  
 201-12-23  
 23 cm / 9"

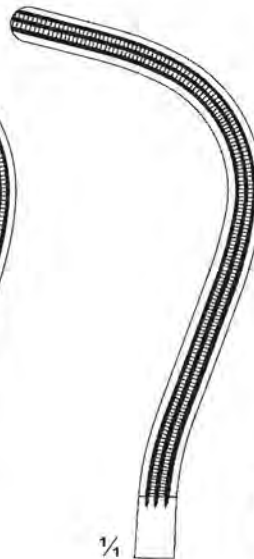

1/4  
 201-13-24  
 24 cm / 9 1/2"



1/2  
 Guyon  
 201-10-23 To 201-13-24



Hysterektomieklemmen ; Pinzas para histerectomía  
Hysterectomy Clamps ; Pinze per isterectomia  
Clamps à hystérectomie ; Pinças para histerectomia

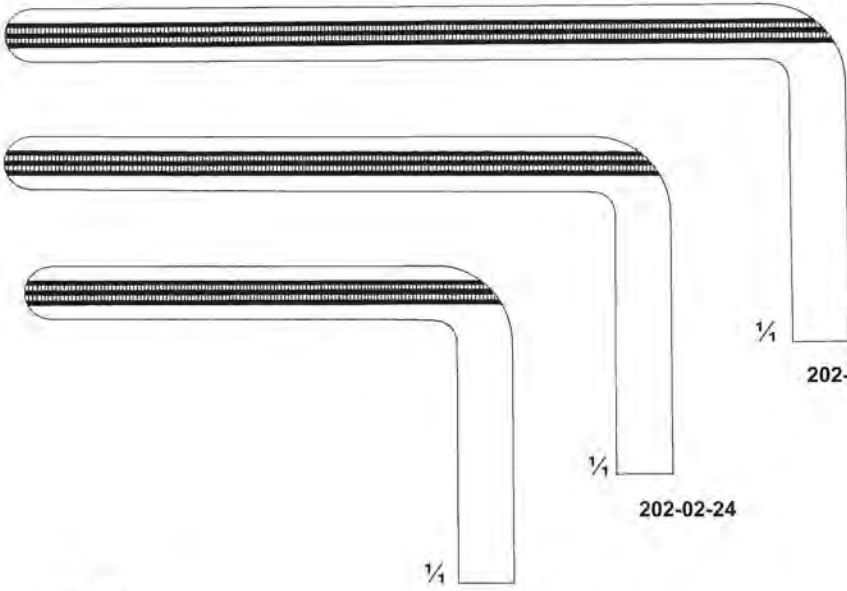

202-01-24

202-02-24

202-03-24

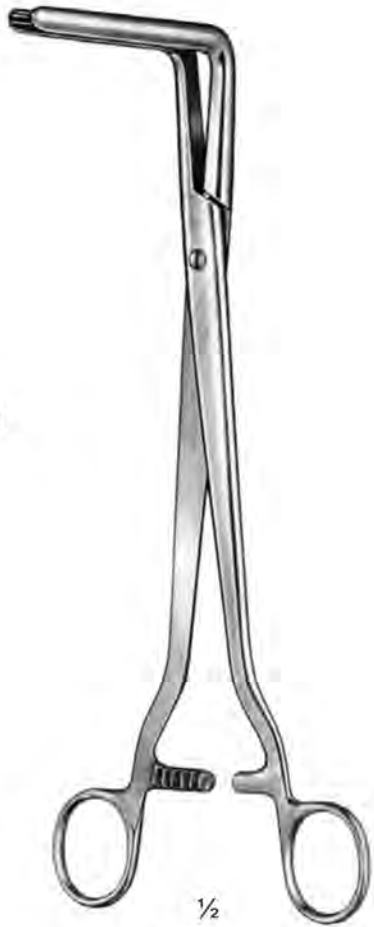

1/2  
Wertheim  
202-01-24 To 202-03-24  
24 cm / 9 1/2"

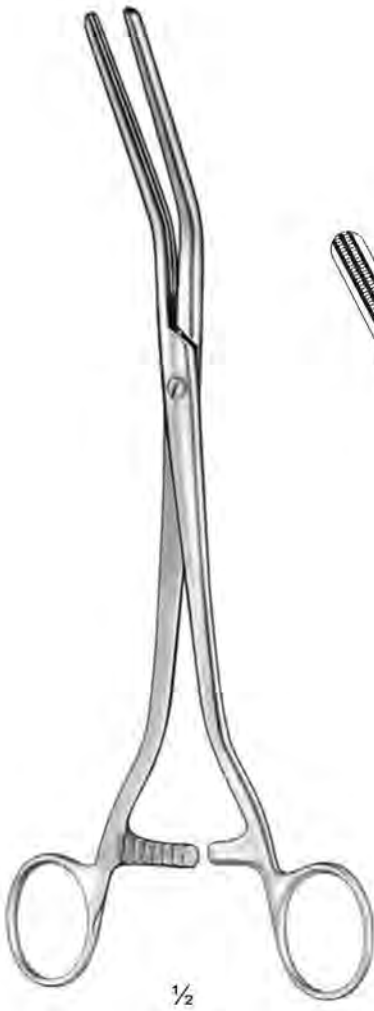

1/2  
Dick  
202-04-25 To 202-06-27

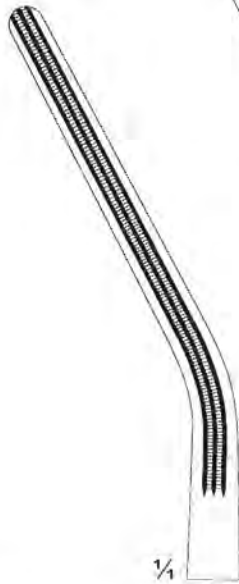

202-04-25  
25 cm / 10"

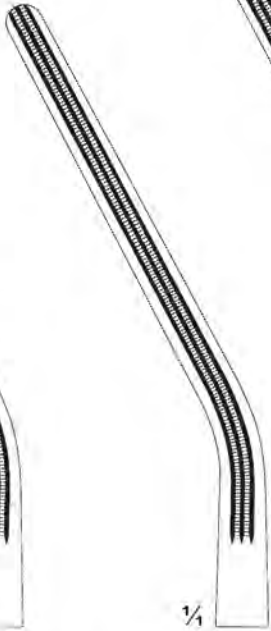

202-05-26  
26 cm / 10 1/4"

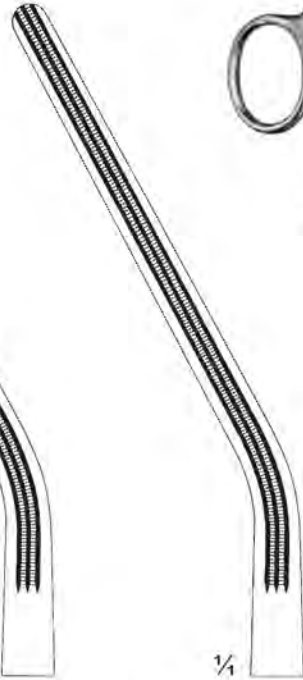

202-06-27  
27 cm / 10 3/4"

Hysterektomieklemmen ; Pinzas para histerectomía  
 Hysterectomy Clamps ; Pinze per isterectomia  
 Clamps à hystérectomie ; Pinças para histerectomia

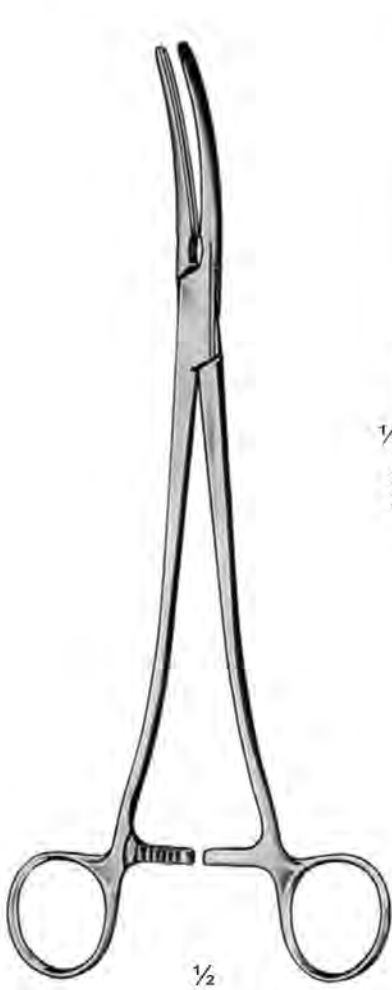

$\frac{1}{2}$   
 Wertheim  
 203-01-25 To 203-04-23



$\frac{1}{4}$   
 203-01-25  
 25 cm / 10"



$\frac{1}{4}$   
 203-02-24  
 24.5 cm / 9 $\frac{3}{4}$ "



$\frac{1}{4}$   
 203-03-24  
 24 cm / 9 $\frac{1}{2}$ "

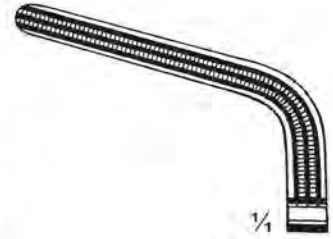

$\frac{1}{4}$   
 203-04-23  
 23 cm / 9"



$\frac{1}{2}$   
 Uro-Tangential  
 203-05-26 & 203-06-26  
 26 cm / 10 $\frac{1}{4}$ "

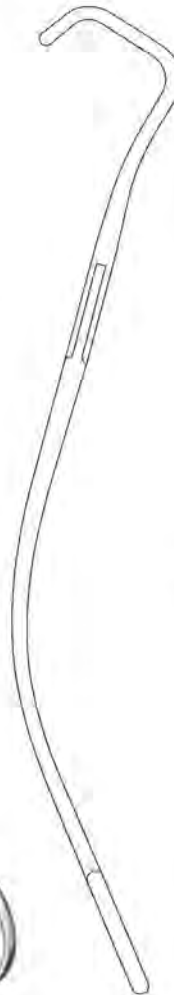

$\frac{1}{4}$   
 203-05-26



$\frac{1}{4}$   
 203-06-26

**Peritoneumklemmen ; Pinzas para peritoneo  
Peritoneal Clamp Forceps ; Pinze per peritoneo  
Pince à péritoine ; Pinças peritônio**

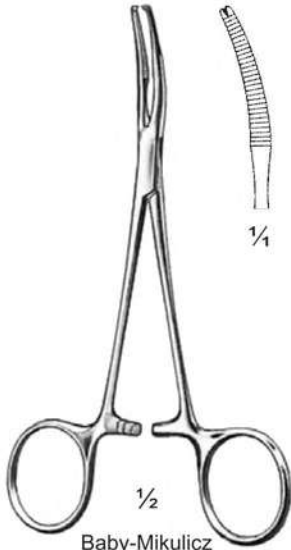

**Baby-Mikulicz**  
**204-01-14**  
14 cm / 5½"  
1 X 2 Teeth

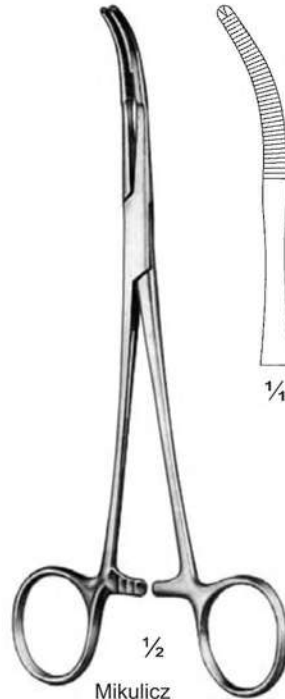

**Mikulicz**  
**204-02-18**  
18 cm / 7"  
1 X 2 Teeth

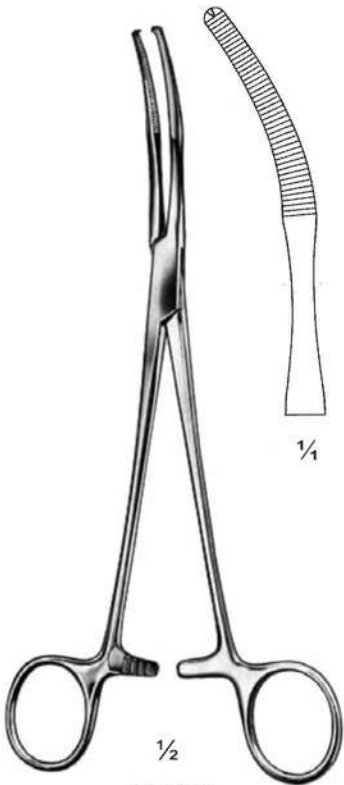

**Mikulicz**  
**204-03-20**  
20 cm / 8"  
1 X 2 Teeth

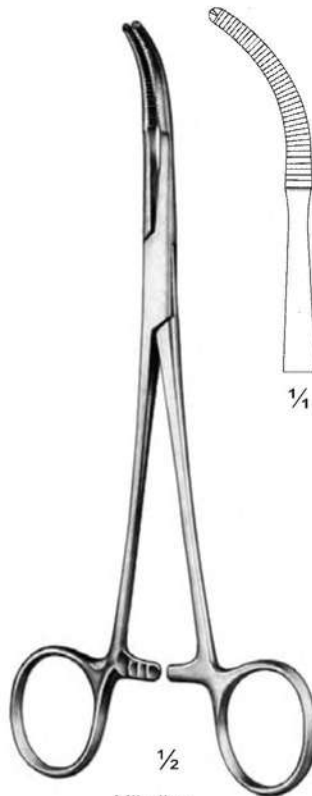

**Mikulicz**  
**204-04-20**  
20 cm / 8"  
1 X 2 Teeth

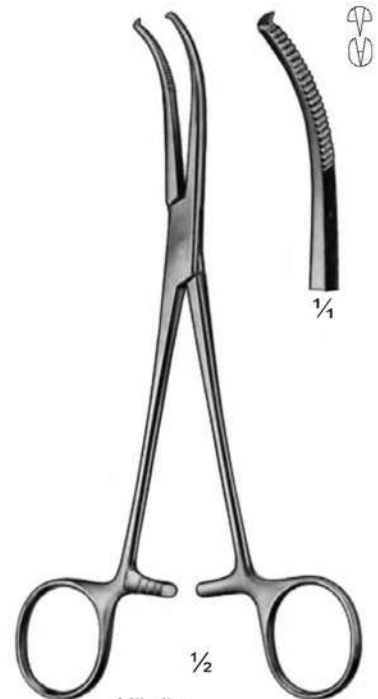

**Mikulicz**  
**204-05-18**  
18.5 cm / 7¼"  
1 X 2 Teeth

**Peritoneumklemmen ; Pinzas para peritoneo  
Peritoneal Clamp Forceps ; Pinze per peritoneo  
Pince à péritoine ; Pinças peritônio**

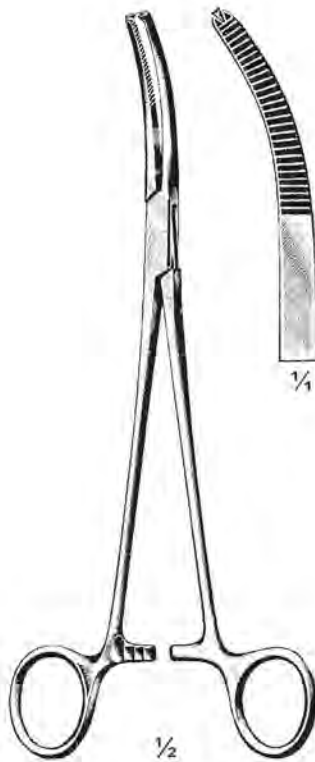

$\frac{1}{2}$   
Mikulicz  
205-01-20  
20 cm / 8"  
1 X 2 Teeth

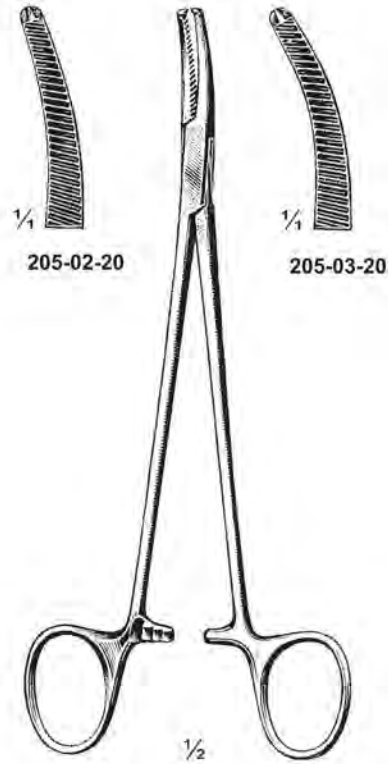

$\frac{1}{2}$   
Faure  
205-02-20 & 205-03-20  
20 cm / 8"  
1 X 2 Teeth

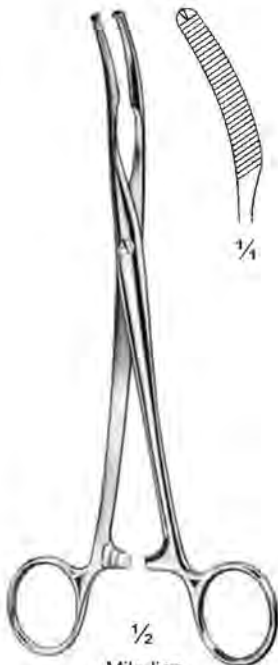

$\frac{1}{2}$   
Mikulicz  
205-04-18  
18 cm / 7"  
1 X 2 Teeth



$\frac{1}{2}$   
Mikulicz  
205-05-20 & 205-06-20  
20 cm / 8"  
1 X 2 Teeth

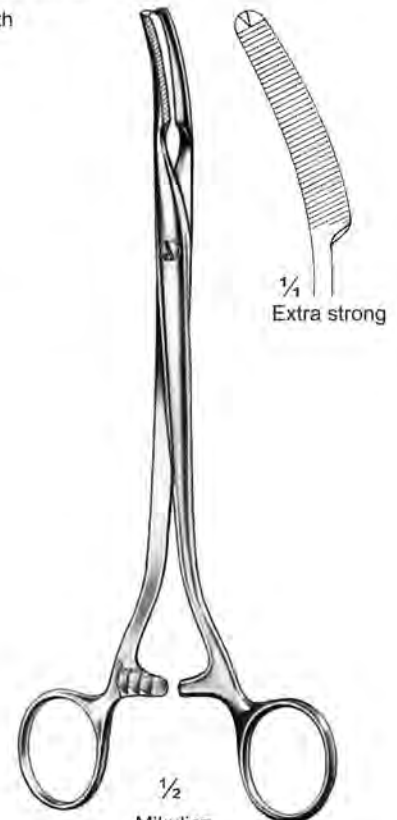

$\frac{1}{2}$   
Mikulicz  
205-07-20  
20 cm / 8"  
1 X 2 Teeth

**Peritoneumklemmen ; Pinzas para peritoneo  
Peritoneal Clamp Forceps ; Pinze per peritoneo  
Pince à péritoine ; Pinças peritônio**

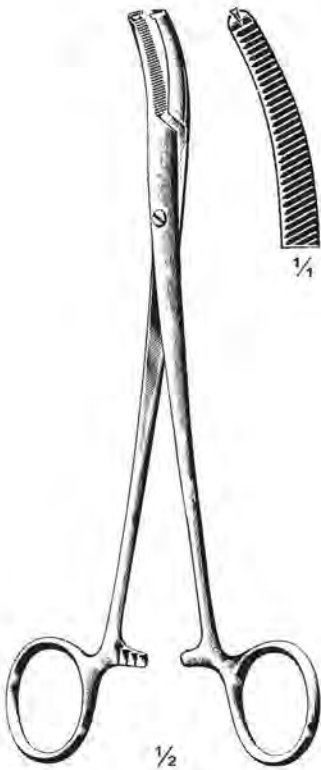

Mikulicz  
206-01-20  
20 cm / 8"  
1 X 2 Teeth



Mikulicz  
206-02-23  
23 cm / 9"  
1 X 2 Teeth



Schindler  
206-03-20  
20 cm / 8"  
1 X 2 Teeth



**Bulldogklemmen ; Pinzas Bulldog  
Bulldog Clamps ; Morsetti Bulldog  
Clamps Bulldog ; Pinças Bulldog**



1/4



1/4



1/4



1/4



1/4



1/4

Dieffenbach  
207-01-03 3.5 cm / 1 3/8"  
207-02-05 5 cm / 2"  
207-03-06 6 cm / 2 3/8"  
207-04-06 6.5 cm / 2 1/2"  
207-05-07 7 cm / 2 3/4"  
207-06-08 8 cm / 3"

Dieffenbach  
207-07-03 3.5 cm / 1 3/8"  
207-08-05 5 cm / 2"  
207-09-06 6 cm / 2 3/8"  
207-10-06 6.5 cm / 2 1/2"  
207-11-07 7 cm / 2 3/4"  
207-12-08 8 cm / 3"

Dieffenbach  
207-13-03 3.5 cm / 1 3/8"  
207-14-05 5 cm / 2"  
207-15-06 6 cm / 2 3/8"  
207-16-06 6.5 cm / 2 1/2"  
207-17-07 7 cm / 2 3/4"  
207-18-08 8 cm / 3"

Dieffenbach  
207-19-03 3.5 cm / 1 3/8"  
207-20-05 5 cm / 2"  
207-21-06 6 cm / 2 3/8"  
207-22-06 6.5 cm / 2 1/2"  
207-23-07 7 cm / 2 3/4"  
207-24-08 8 cm / 3"

Johns-Hopkins  
207-25-04 4 cm / 1 1/2"  
207-26-05 5 cm / 2"  
207-27-06 6 cm / 2 3/8"  
207-28-06 6.5 cm / 2 1/2"  
207-29-07 7 cm / 2 3/4"  
207-30-08 8 cm / 3"  
207-31-09 9 cm / 3 1/2"

Johns-Hopkins  
207-32-04 4 cm / 1 1/2"  
207-33-05 5 cm / 2"  
207-34-06 6 cm / 2 3/8"  
207-35-06 6.5 cm / 2 1/2"  
207-36-07 7 cm / 2 3/4"  
207-37-08 8 cm / 3"  
207-38-09 9 cm / 3 1/2"



1/4

207-39-03

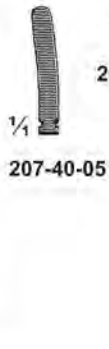

1/4

207-40-05



1/4

207-41-05

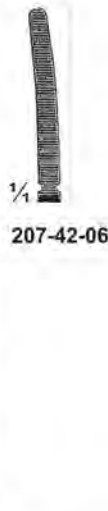

1/4

207-42-06



1/4

207-43-07

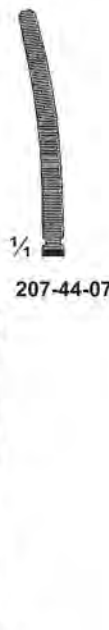

1/4

207-44-07



1/4

207-45-09



1/4

Johns-Hopkins  
207-39-03 3.8 cm / 1 1/2"  
207-40-05 5.1 cm / 2"

Johns-Hopkins  
207-41-05 5.7 cm / 2 1/4"  
207-42-06 6.3 cm / 2 1/2"

Johns-Hopkins  
207-43-07 7 cm / 2 3/4"  
207-44-07 7.6 cm / 3"

Johns-Hopkins  
207-45-09 9 cm / 3 1/2"

De Bakey  
207-46-07 7.5 cm / 3"  
207-47-08 8.5 cm / 3"  
207-48-10 10.5 cm / 4 1/8"  
207-49-12 12.5 cm / 5"





**Bulldogklemmen ; Pinzas Bulldog  
Bulldog Clamps ; Morsetti Bulldog  
Clamps Bulldog ; Pinças Bulldog**



**208-01-05**  
5 cm / 2"  
8 mm Jaw

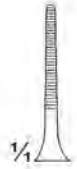

**208-02-05**  
5 cm / 2"  
12 mm Jaw



**208-03-06**  
6 cm / 2 3/4"  
20 mm Jaw



**208-04-05**  
5 cm / 2"  
8 mm Jaw

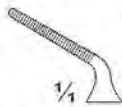

**208-05-05**  
5 cm / 2"  
12 mm Jaw

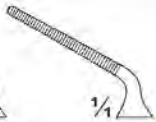

**208-06-06**  
6 cm / 2 3/4"  
20 mm Jaw

208-01-05 To 208-06-06



Micro-Coron  
**208-07-05** 5 cm / 2" 8 mm Jaw  
**208-08-05** 5 cm / 2" 12 mm Jaw  
**208-09-06** 6 cm / 2 3/4" 16 mm Jaw



Micro-Coron  
**208-10-04** 4.5 cm / 1 3/4" 8 mm Jaw  
**208-11-04** 4.5 cm / 1 3/4" 12 mm Jaw  
**208-12-05** 5.5 cm / 2 1/4" 16 mm Jaw



Ultra-Micro  
**208-13-03** 3 cm / 1 1/4"  
**208-14-03** 3.5 cm / 1 3/8"  
**208-15-04** 4 cm / 1 1/2"  
**208-16-05** 5 cm / 2"



Ultra-Micro  
**208-17-03** 3 cm / 1 1/4"  
**208-18-03** 3.5 cm / 1 3/8"  
**208-19-04** 4 cm / 1 1/2"  
**208-20-05** 5 cm / 2"



Ultra-Micro  
**208-21-03** 3 cm / 1 1/4"  
**208-22-03** 3.5 cm / 1 3/8"  
**208-23-04** 4 cm / 1 1/2"  
**208-24-05** 5 cm / 2"



De Bakey-Hess  
**208-25-04**  
Length of  
jaw 20 mm  
4 cm / 1 1/2"



De Bakey-Hess  
**208-26-04**  
Length of  
jaw 30 mm  
4.5 cm / 1 3/4"



Johns-Hopkins  
**208-27-24**  
24.5 cm / 9 3/4"  
For applying and  
removing bulldog clamps



**Bulldogklemmen ; Pinzas Bulldog  
Bulldog Clamps ; Morsetti Bulldog  
Clamps Bulldog ; Pinças Bulldog**

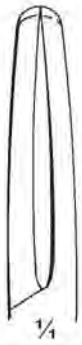

1/4

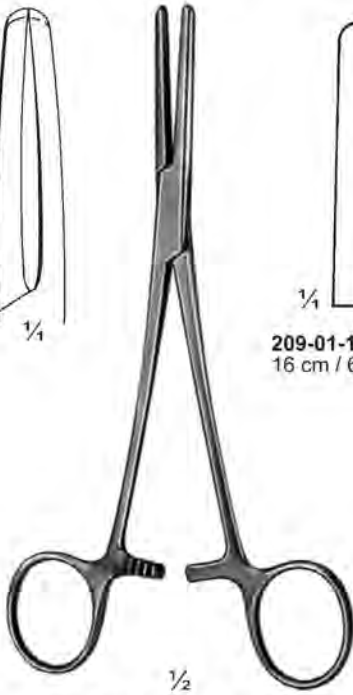

1/2

209-01-16 To 209-0320

209-01-16  
16 cm / 6 1/4"



1/4



1/4

209-02-18  
18 cm / 7"



1/4

209-03-20  
20 cm / 8"



St. Vincent  
209-04-16 16 cm / 6 1/4"  
209-05-18 18 cm / 7"



1/2

Standard  
209-06-15 To 209-08-20



1/4

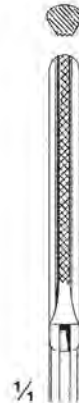

1/4

209-06-15  
15 cm / 6"

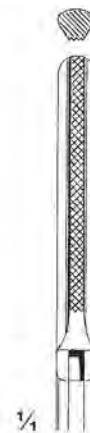

1/4

209-07-18  
18 cm / 7"



1/4

209-08-20  
20 cm / 8"



**Bulldogklemmen ; Pinzas Bulldog  
Bulldog Clamps ; Morsetti Bulldog  
Clamps Bulldog ; Pinças Bulldog**

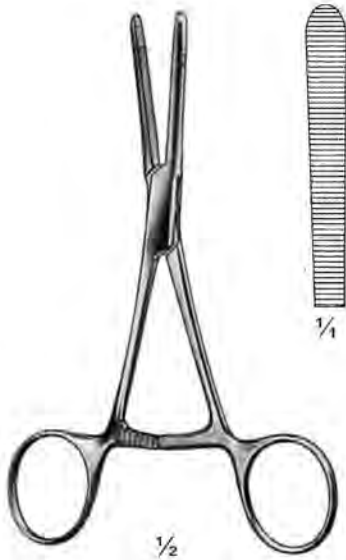

Mod. Klinikum-Berlin  
**210-01-14**  
14.5 cm / 5 3/4"



Marcuse  
**210-02-16** 16.5 cm / 6 1/2"  
**210-03-20** 20 cm / 8"

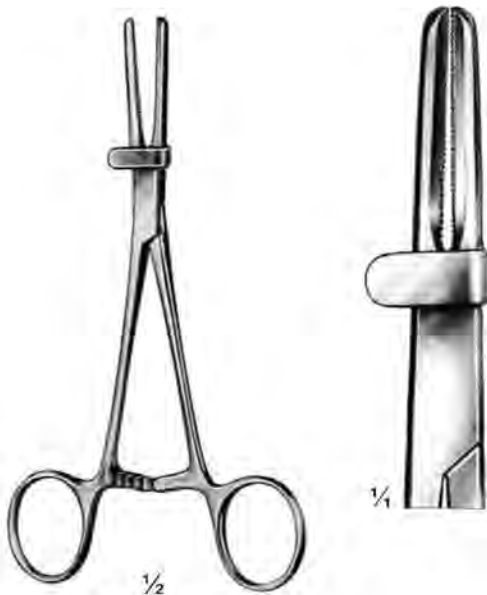

**210-04-15 To 210-06-20**



**210-04-15**  
15 cm / 6"



**210-05-18**  
18 cm / 7"



**210-06-20**  
20 cm / 8"

**Tuchklemmen ; Pinzas de campo  
Towel Forceps ; Pinze fissateli  
Pincès à champs ; Pinças para toalhas**

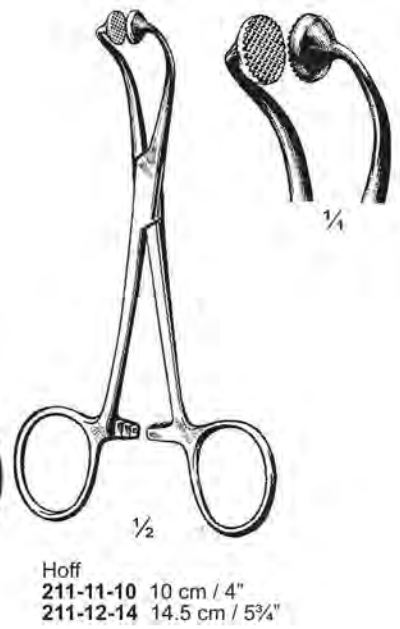
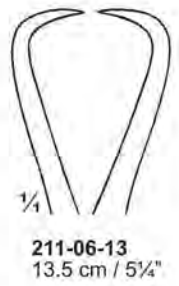
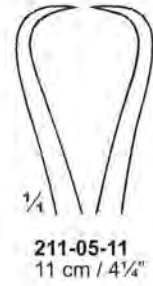
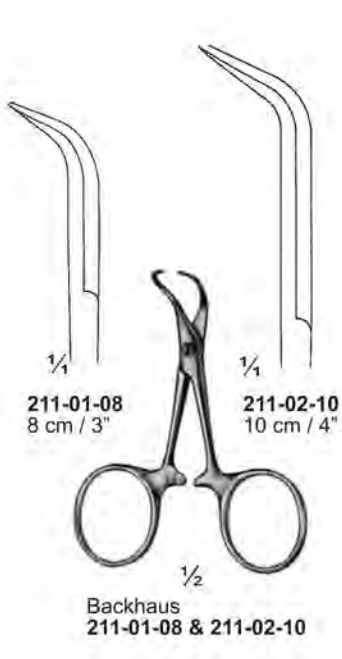

**Tuchklemmen ; Pinzas de campo  
Towel Forceps ; Pinze fissateli  
Pincès à champs ; Pinças para toalhas**

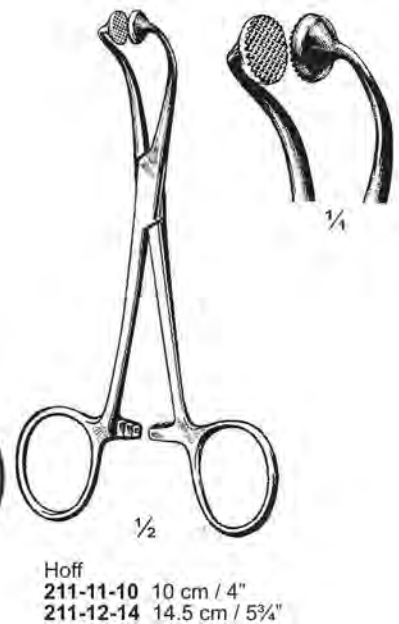
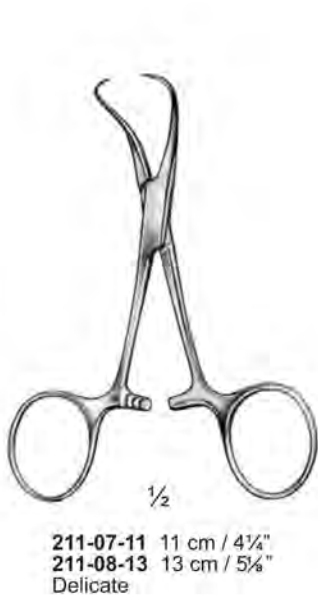
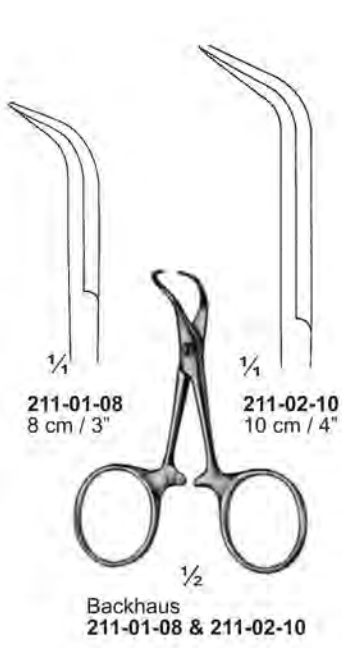

Tuchklemmen ; Pinzas de campo  
Towel Forceps ; Pinze fissateli  
Pincès à champs ; Pinças para toalhas

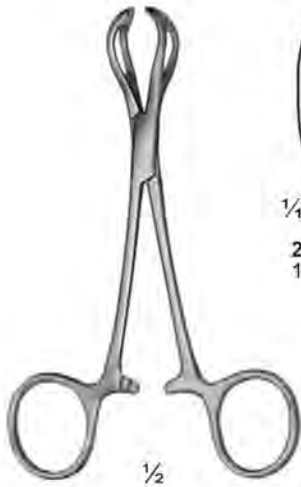

Lane  
213-01-13 To 213-03-19

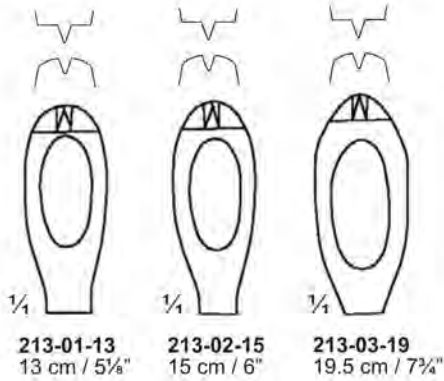

213-04-09  
9.5 cm / 3 3/4"



Bernhard  
213-05-16  
16 cm / 6 1/4"



Lane  
213-06-13 13 cm / 5 1/8"  
213-07-15 15 cm / 6"  
1 X 2 Teeth



Lane  
213-08-15 15 cm / 6"  
213-09-18 18 cm / 7"  
213-10-20 20 cm / 8"  
2 X 3 Teeth



Moynihan  
213-11-19  
19 cm / 7 1/2"  
2 X 2 Teeth



Moynihan  
213-12-17 17 cm / 6 3/4"  
213-13-19 19 cm / 7 1/2"  
2 X 3 Teeth

**Tuchklemmen ; Pinzas de campo  
Towel Forceps ; Pinze fissateli  
Pincès à champs ; Pinças para toalhas**

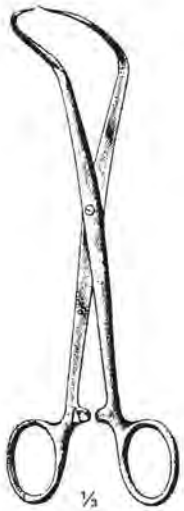

Schaedel  
214-01-19  
19.5 cm / 7 $\frac{3}{4}$ "



Jones  
214-02-05 5 cm / 2"  
214-03-09 9 cm / 3 $\frac{1}{2}$ "



Jones  
214-04-09  
9 cm / 3 $\frac{1}{2}$ "  
With clip for tubing



Schaedel  
214-05-09 9 cm / 3 $\frac{1}{2}$ "  
214-06-10 10 cm / 4"



Schaedel  
214-07-09 9 cm / 3 $\frac{1}{2}$ "  
214-08-10 10 cm / 4"



Engl. Model  
214-09-09 9 cm / 3 $\frac{1}{2}$ "  
214-10-10 10 cm / 4"



Engl. Model  
214-11-09 9 cm / 3 $\frac{1}{2}$ "  
214-12-10 10 cm / 4"



Doyen  
214-13-18  
18 cm / 7"  
2 X 3 Teeth



Doyen  
214-14-15 15 cm / 6"  
214-15-18 18 cm / 7"



Doyen  
214-16-15 15 cm / 6"  
214-17-18 18 cm / 7"  
2 X 2 Teeth



Doyen  
214-18-13 13.5 cm / 5 $\frac{1}{4}$ "  
214-19-16 16 cm / 6 $\frac{1}{4}$ "  
214-20-18 18 cm / 7"



**Tupferzangen ; Pinzas para tampones  
Dressing Forceps ; Pinze per medicatura  
Pincès à tampons ; Pinças para tampões**



Foerster  
215-01-16 To 215-24-25

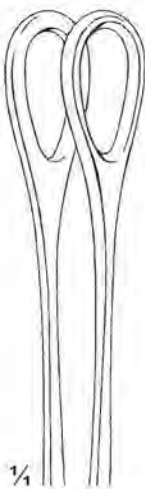

- 215-01-16 16 cm / 6 1/4"
- 215-02-18 18 cm / 7"
- 215-03-20 20 cm / 8"
- 215-04-23 23 cm / 9"
- 215-05-24 24 cm / 9 1/2"
- 215-06-25 25 cm / 10"

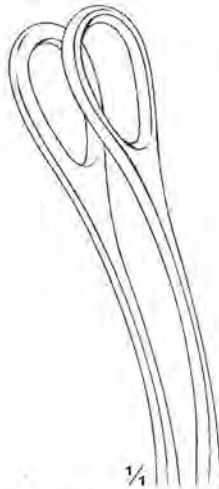

- 215-07-16 16 cm / 6 1/4"
- 215-08-18 18 cm / 7"
- 215-09-20 20 cm / 8"
- 215-10-23 23 cm / 9"
- 215-11-24 24 cm / 9 1/2"
- 215-12-25 25 cm / 10"

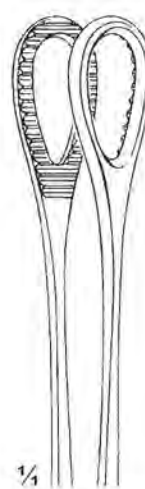

- 215-13-16 16 cm / 6 1/4"
- 215-14-18 18 cm / 7"
- 215-15-20 20 cm / 8"
- 215-16-23 23 cm / 9"
- 215-17-24 24 cm / 9 1/2"
- 215-18-25 25 cm / 10"

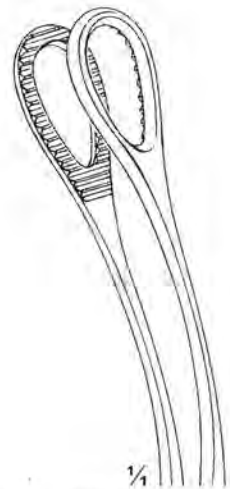

- 215-19-16 16 cm / 6 1/4"
- 215-20-18 18 cm / 7"
- 215-21-20 20 cm / 8"
- 215-22-23 23 cm / 9"
- 215-23-24 24 cm / 9 1/2"
- 215-24-25 25 cm / 10"

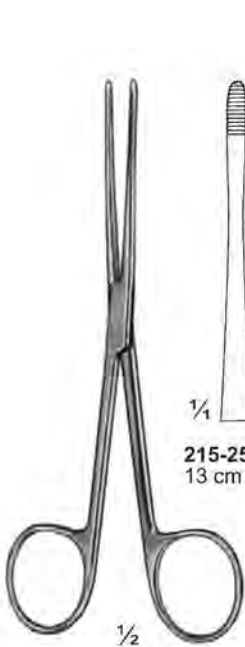

Lister  
215-25-13 To 215-27-18



- 215-25-13  
13 cm / 5 1/8"



- 215-26-15  
15 cm / 6"



- 215-27-18  
18 cm / 7"



215-28-18  
18 cm / 7"



215-29-18  
18 cm / 7"

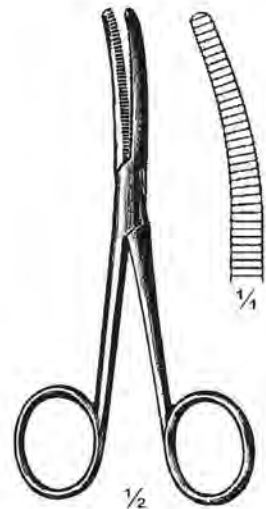

Bryant  
215-30-13  
13 cm / 5 1/8"





**Tupferzangen ; Pinzas para tampones  
Dressing Forceps ; Pinze per medicatura  
Pincers à tampons ; Pinças para tampões**

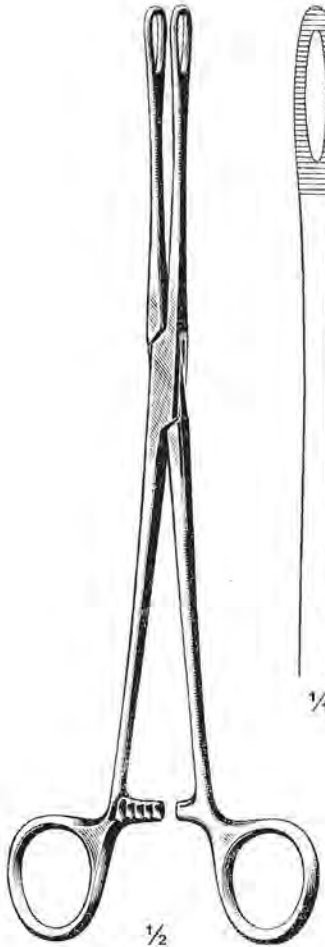

Foerster  
216-01-16 To 216-12-25



- 216-01-16 16 cm / 6¼"
- 216-02-18 18 cm / 7"
- 216-03-20 20 cm / 8"
- 216-04-23 23 cm / 9"
- 216-05-24 24 cm / 9½"
- 216-06-25 25 cm / 10"

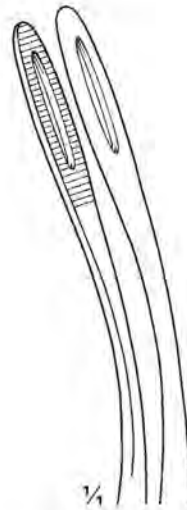

- 216-07-16 16 cm / 6¼"
- 216-08-18 18 cm / 7"
- 216-09-20 20 cm / 8"
- 216-10-23 23 cm / 9"
- 216-11-24 24 cm / 9½"
- 216-12-25 25 cm / 10"



Bryant  
216-13-13  
13 cm / 5"



Gross  
216-14-14 To 216-21-20

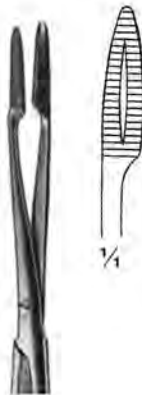

- 216-14-14 14.5 cm / 5¾"
- 216-15-16 16 cm / 6¼"
- 216-16-18 18 cm / 7"
- 216-17-20 20 cm / 8"
- 216-18-14 18 cm / 7"
- 216-19-16 19 cm / 7½"
- 216-20-18 20 cm / 8"
- 216-21-20 21 cm / 8½"



Gross  
216-22-14 To 216-29-20



- 216-22-14 14.5 cm / 5¾"
- 216-23-16 16 cm / 6¼"
- 216-24-18 18 cm / 7"
- 216-25-20 20 cm / 8"
- 216-26-14 14 cm / 5½"
- 216-27-16 16 cm / 6¼"
- 216-28-18 18 cm / 7"
- 216-29-20 20 cm / 8"

**Tupferzangen ; Pinzas para tampones  
Dressing Forceps ; Pinze per medicatura  
Pinces à tampons ; Pinças para tampões**

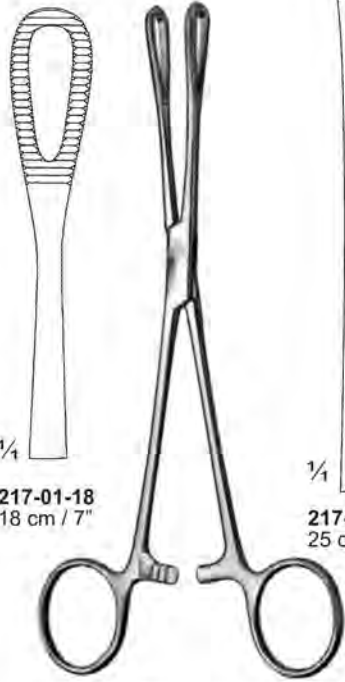

217-01-18  
18 cm / 7"

217-02-25  
25 cm / 10"

Rampley  
217-01-18 & 217-02-25

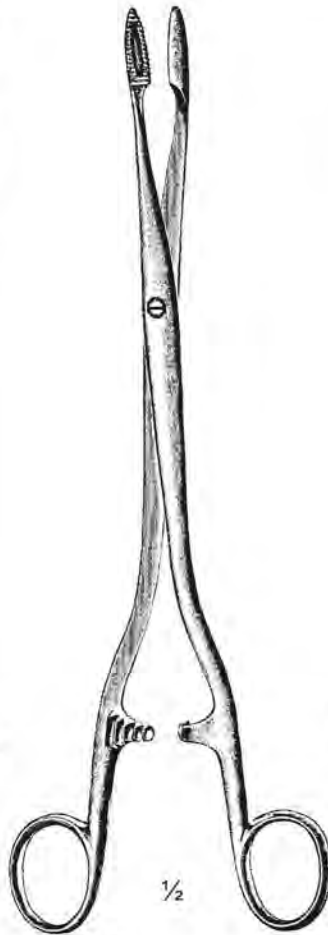

1/2

Duplay  
217-03-25 & 217-04-25  
25.5 cm / 10 1/8"



1/2  
217-03-25

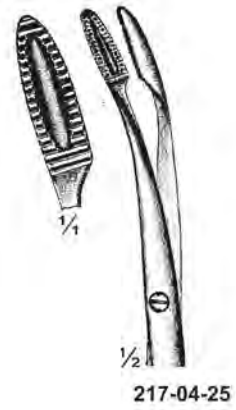

1/2  
217-04-25



1/2

Foerster  
217-05-19 To 217-12-24



1/4

Str  
217-05-19 19 cm / 7 1/2"  
217-06-24 24 cm / 9 1/2"



1/4

Str  
217-09-19 19 cm / 7 1/2"  
217-10-24 24 cm / 9 1/2"

Cur  
217-07-19 19 cm / 7 1/2"  
217-08-24 24 cm / 9 1/2"



2/5

Kelly  
217-13-32  
32 cm / 12 1/2"



1/4

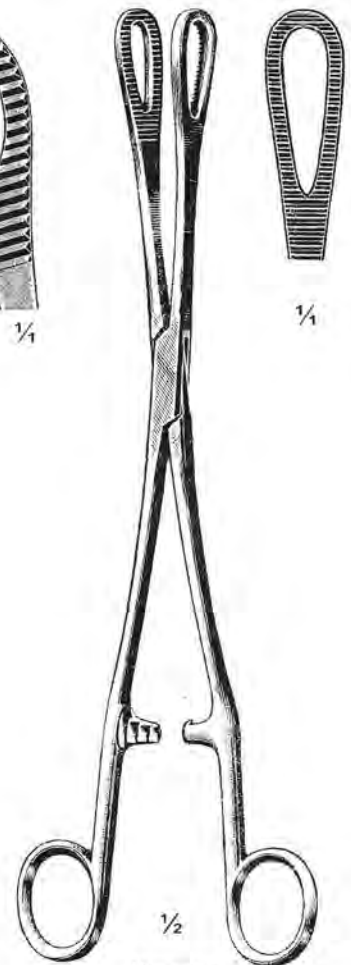

1/4

Rampley  
217-14-25  
25 cm / 10"

Tupferzangen ; Pinzas para tampones  
 Dressing Forceps ; Pinze per medicatura  
 Pincers à tampons ; Pinças para tampões

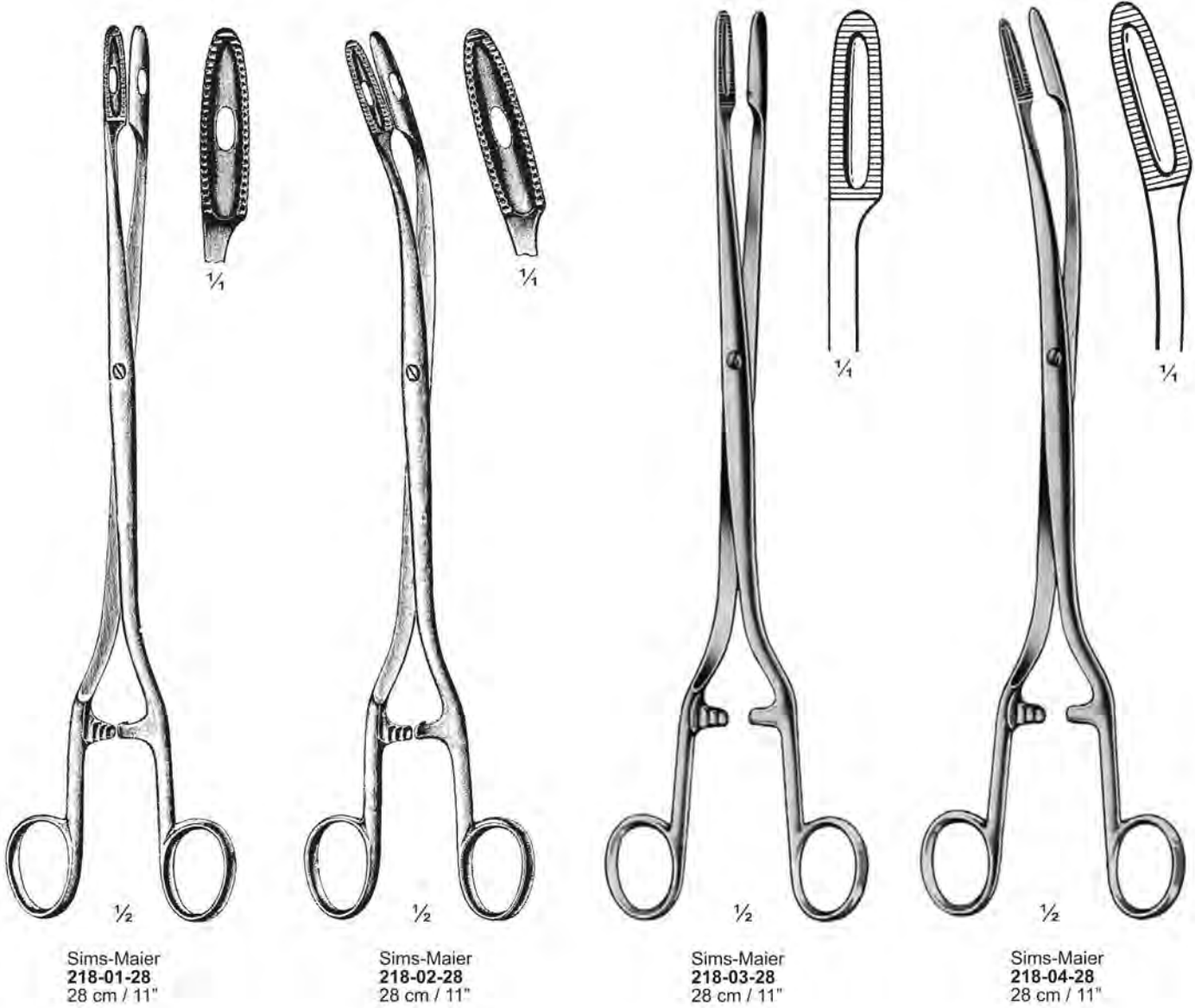

**Tupferzangen ; Pinzas para tampones  
Dressing Forceps ; Pinze per medicatura  
Pincès à tampons ; Pinças para tampões**

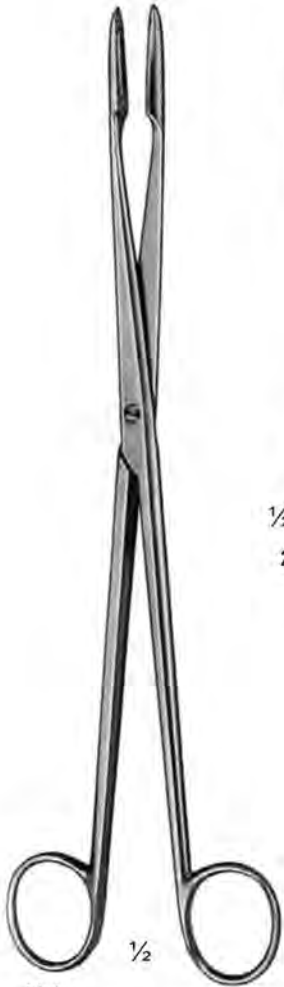

Maier  
219-01-26 & 219-02-26  
26 cm / 10 1/4"

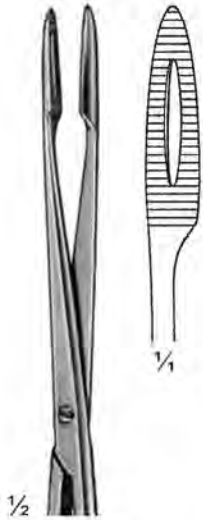

219-01-26



219-02-26

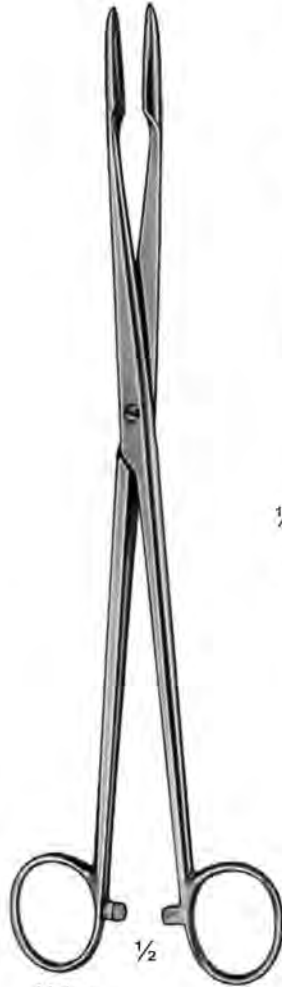

Maier  
219-03-26 & 219-04-26  
26 cm / 10 1/4"

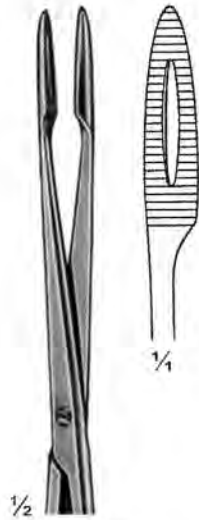

219-03-26



219-04-26

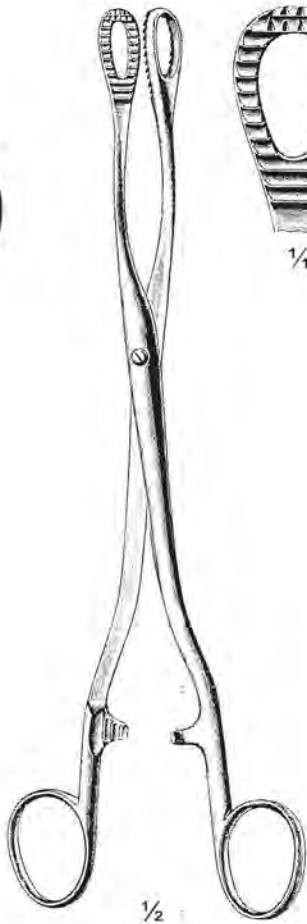

Heywood-Smith  
219-05-25  
25 cm / 10"



1/4

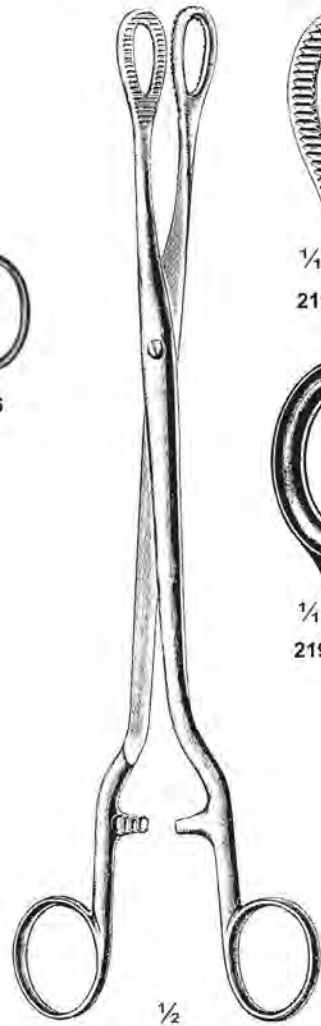

Noto  
219-06-27 & 219-07-27  
27.5 cm / 10 3/4"



219-06-27



219-07-27

**Tupferzangen ; Pinzas para tampones  
Dressing Forceps ; Pinze per medicatura  
Pincès à tampons ; Pinças para tampões**



Pelkman  
220-01-25 & 220-02-25  
25 cm / 10"

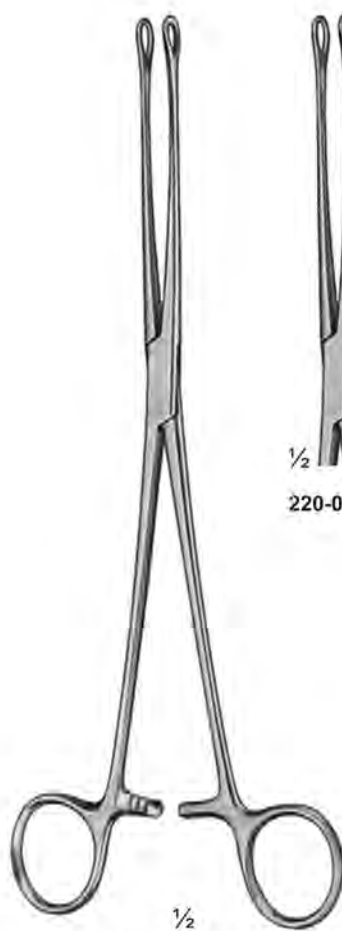

Bergmann-Foerster  
220-03-24 & 220-04-24  
24 cm / 9½"

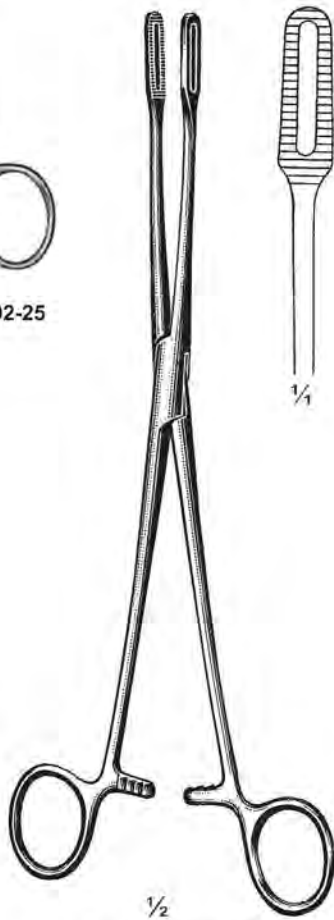
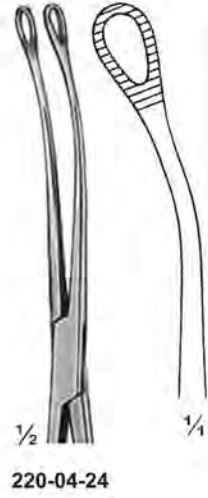

¼

Fletcher (Javerts)  
220-05-24  
24 cm / 9½"



½

Fletcher (Javerts)  
220-06-24  
24 cm / 9½"



**Tupferzangen ; Pinzas para tampones  
Dressing Forceps ; Pinze per medicatura  
Pincès à tampons ; Pinças para tampões**



221-01-17 & 221-02-17  
17 cm / 6 3/4"



221-03-25 & 221-04-25  
25 cm / 10"

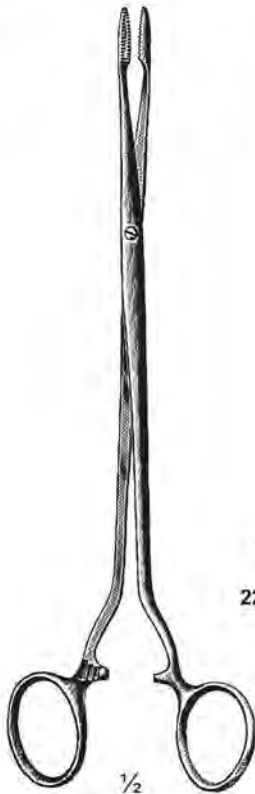
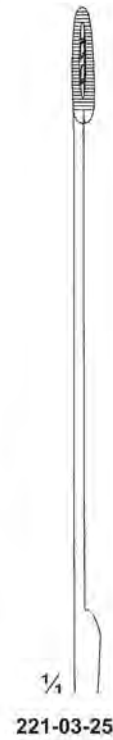

Duplay  
221-05-20 & 221-06-20  
20 cm / 8"

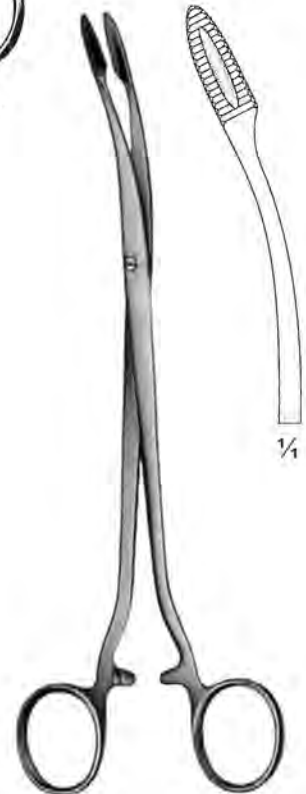

Duplay  
221-07-19  
19 cm / 7 1/2"

**Tupferzangen ; Pinzas para tampones  
Dressing Forceps ; Pinze per medicatura  
Pincès à tampons ; Pinças para tampões**

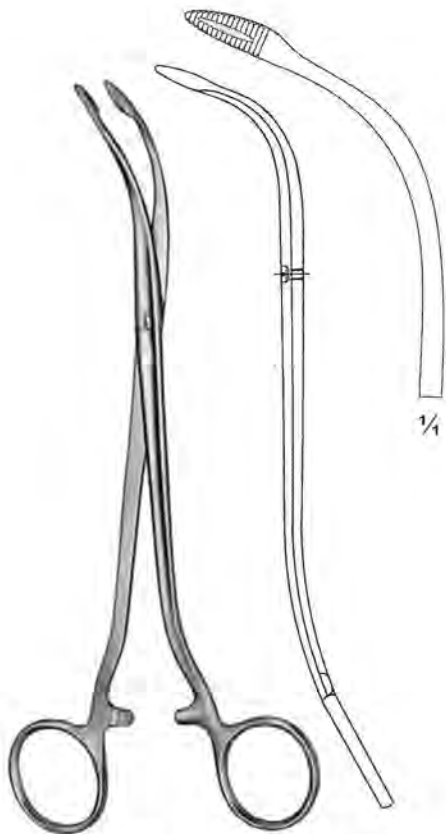

Pitha  
222-01-22  
22.5 cm / 8¾"



Pitha  
222-02-22  
22.5 cm / 8¾"



Pitha  
222-03-22  
22.5 cm / 8¾"



Gross  
222-04-14 14.5 cm / 5¾"  
222-05-16 16 cm / 6¼"  
222-06-18 18 cm / 7"  
222-07-20 20 cm / 8"



Gross  
222-08-14 14.5 cm / 5¾"  
222-09-16 16 cm / 6¼"  
222-10-18 18 cm / 7"  
222-11-20 20 cm / 8"

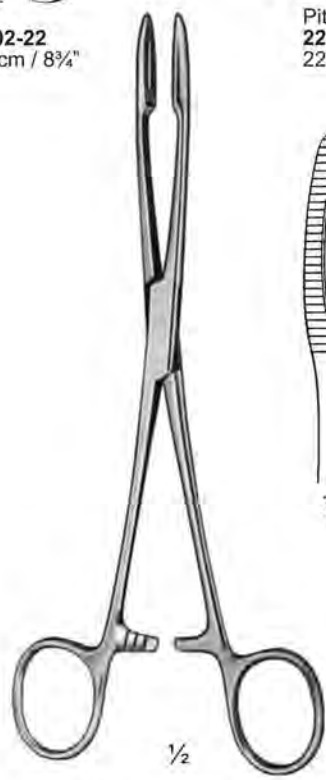

Gross  
222-12-14 14.5 cm / 5¾"  
222-13-16 16 cm / 6¼"  
222-14-18 18 cm / 7"  
222-15-20 20 cm / 8"

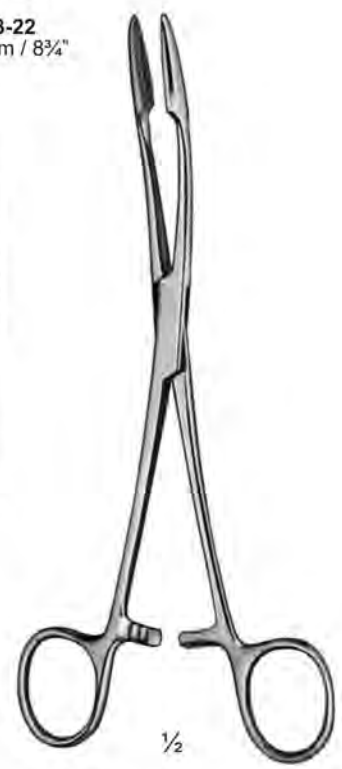

Gross  
222-16-14 14.5 cm / 5¾"  
222-17-16 16 cm / 6¼"  
222-18-18 18 cm / 7"  
222-19-20 20 cm / 8"

**Tupferzangen ; Pinzas para tampones  
Dressing Forceps ; Pinze per medicatura  
Pincers à tampons ; Pinças para tampões**

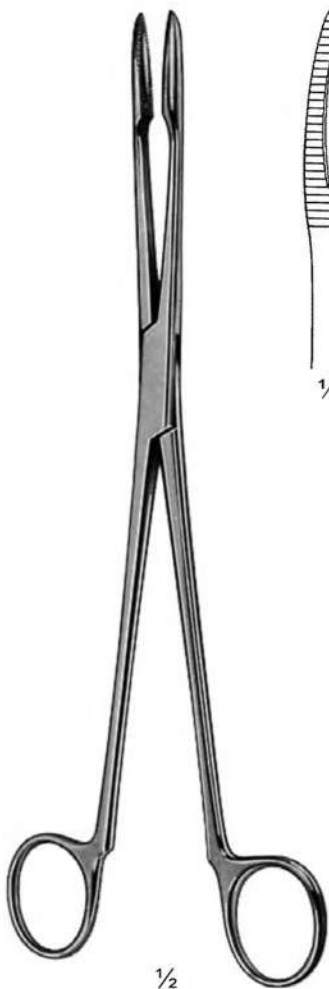

Maier  
223-01-26  
26 cm / 10 1/4"



Maier  
223-02-26  
26 cm / 10 1/4"



Maier  
223-03-26  
26 cm / 10 1/4"

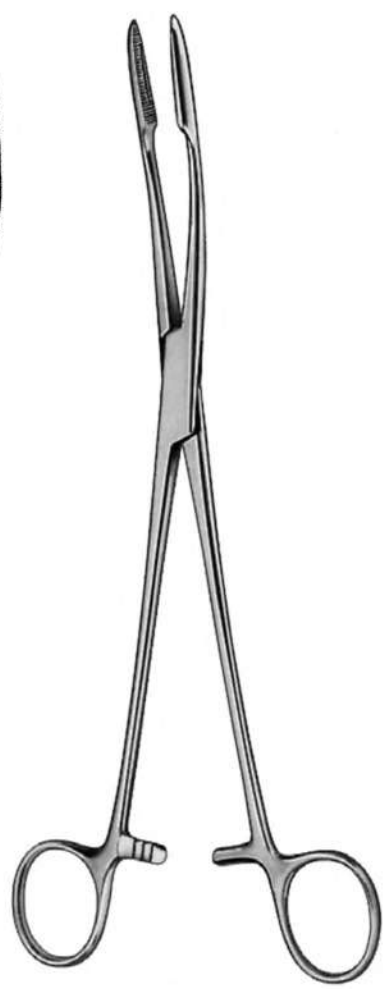

Maier  
223-04-26  
26 cm / 10 1/4"



**Tupferzangen ; Pinzas para tampones  
Dressing Forceps ; Pinze per medicatura  
Pincès à tampons ; Pinças para tampões**

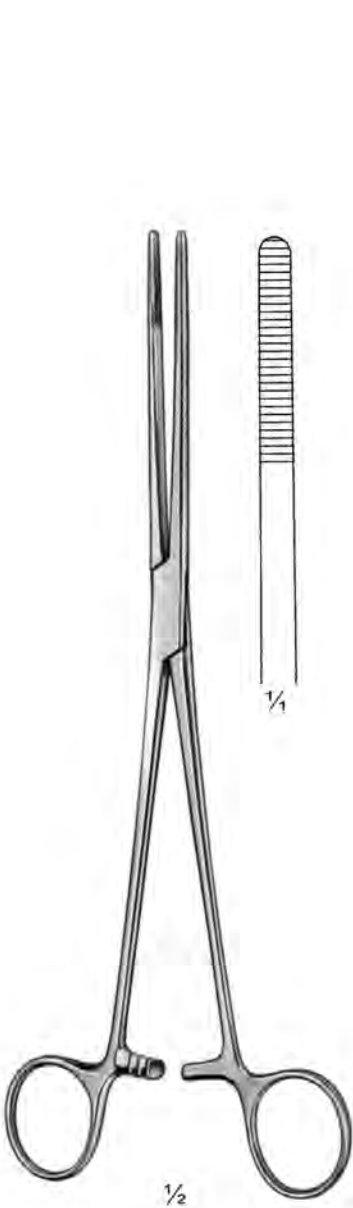

Bozemann  
224-01-26  
26 cm / 10 1/4"

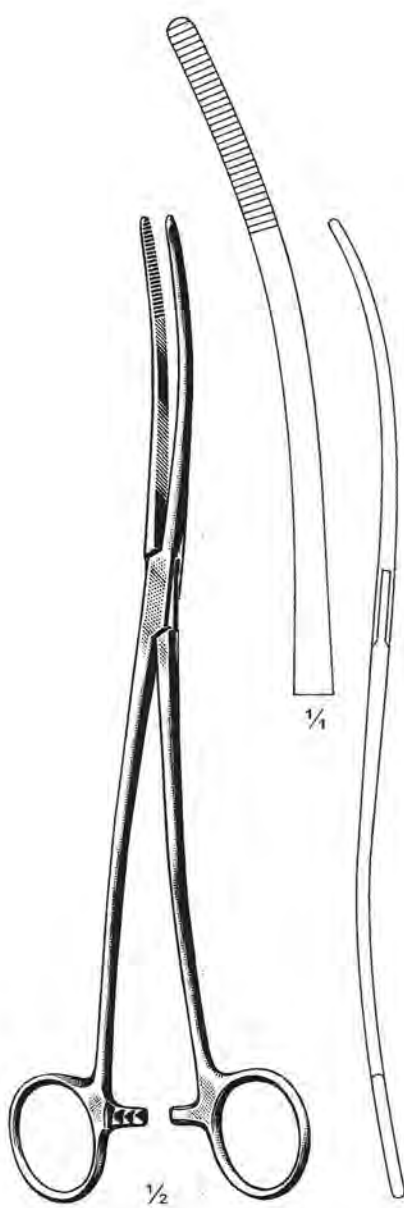

Bozemann  
224-02-26  
26 cm / 10 1/4"

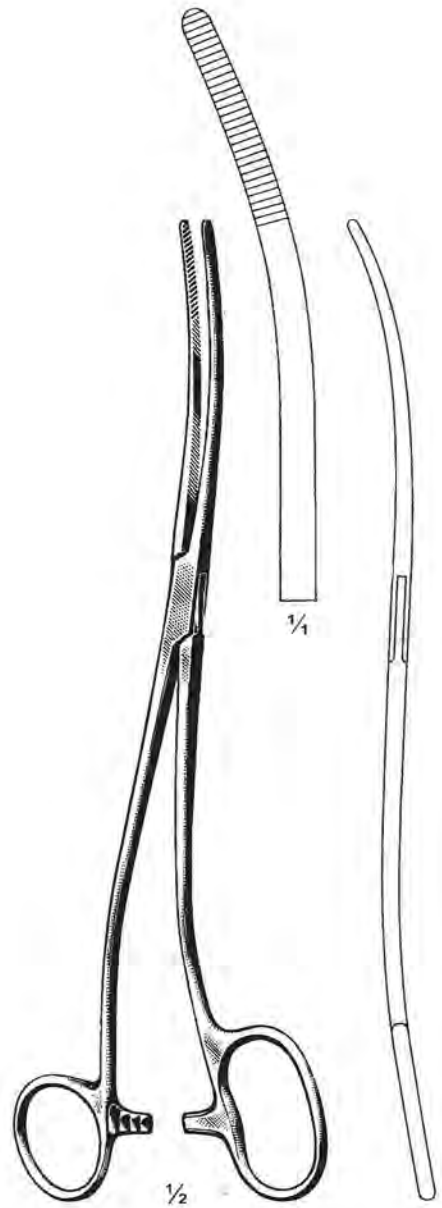

Bozemann-Douglas  
224-03-26  
26 cm / 10 1/4"

Tupferzangen ; Pinzas para tampones  
 Dressing Forceps ; Pinze per medicatura  
 Pincers à tampons ; Pinças para tampões

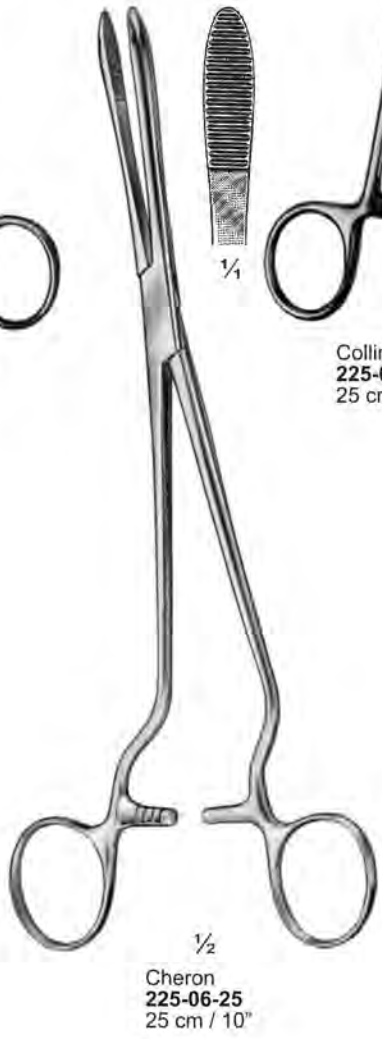
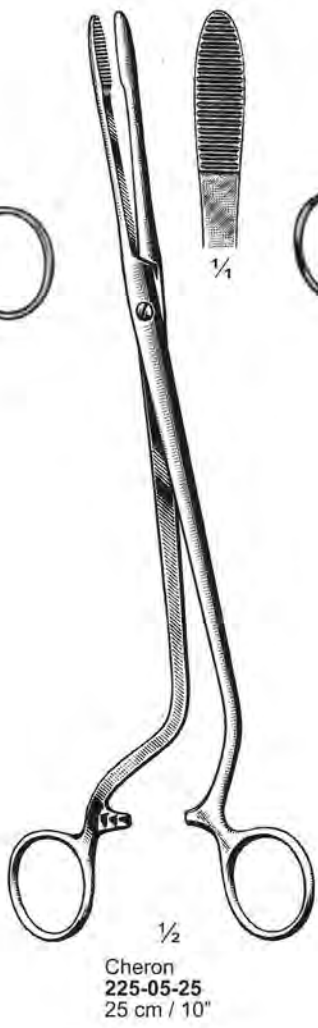
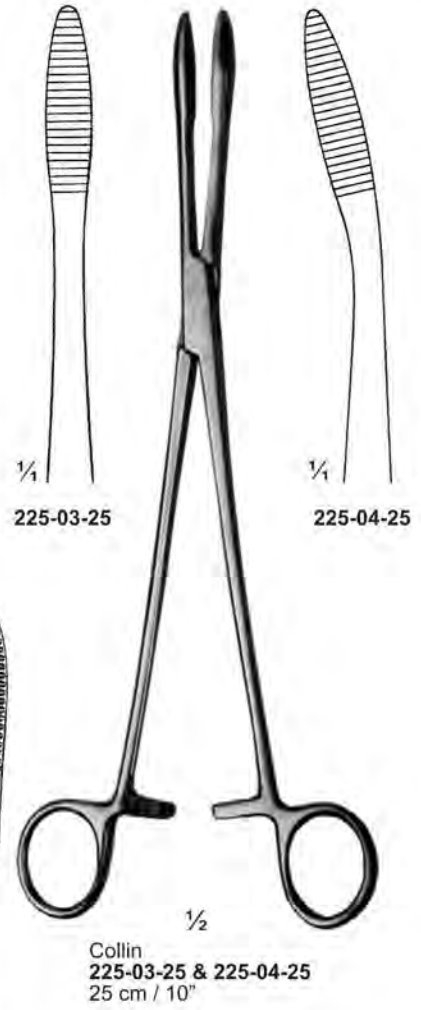
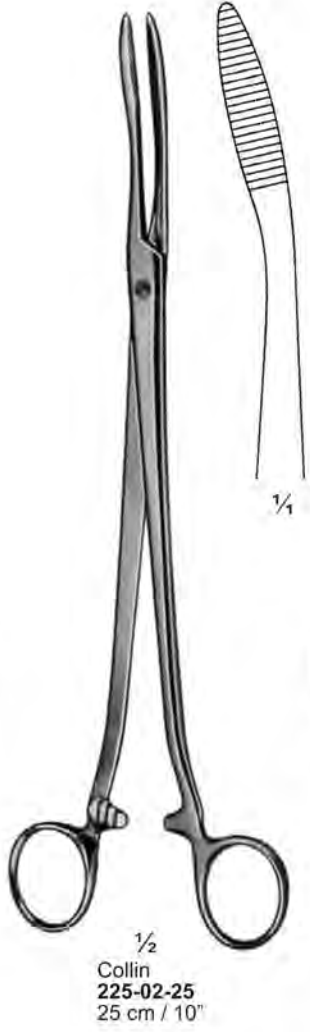
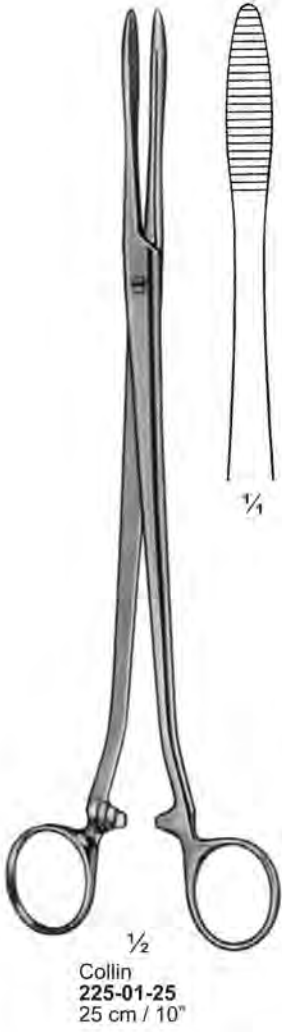

**Tupferzangen ; Pinzas para tampones  
Dressing Forceps ; Pinze per medicatura  
Pincès à tampons ; Pinças para tampões**

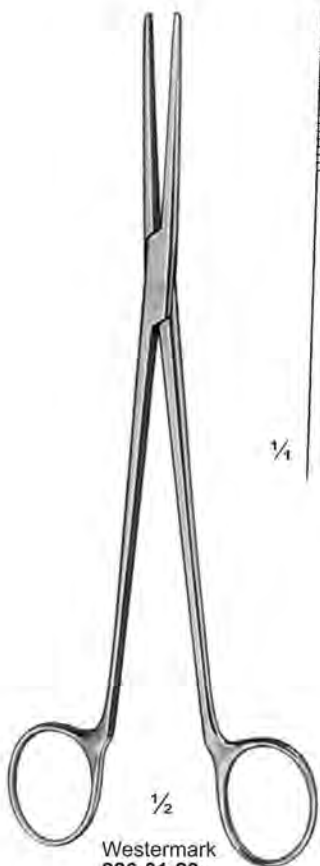

Westernmark  
**226-01-23**  
23 cm / 9"



Westernmark  
**226-02-23**  
23 cm / 9"

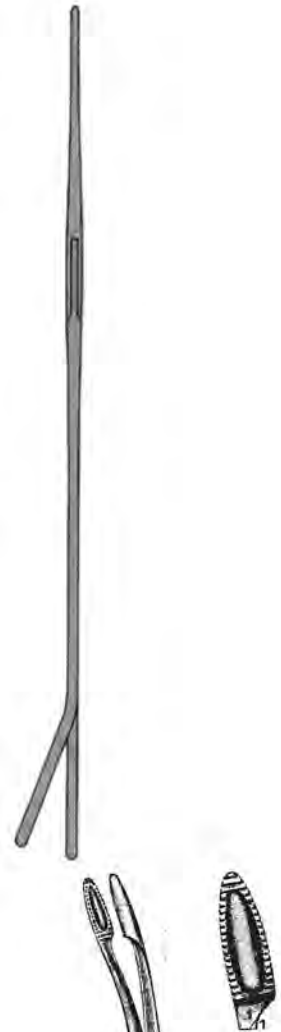

**226-05-24**  
24 cm / 9 1/2"

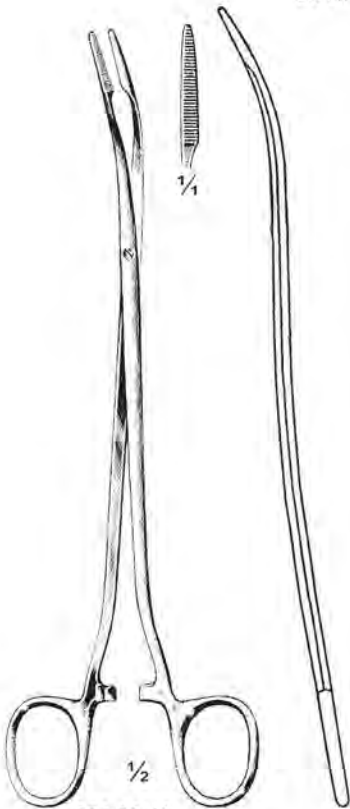

**226-03-19**  
19.5 cm / 7 3/4"



**226-04-24**  
24.5 cm / 9 3/4"

**Tupferzangen ; Pinzas para tampones  
Dressing Forceps ; Pinze per medicatura  
Pincès à tampons ; Pinças para tampões**



Ulrich  
227-01-22 To 227-03-27

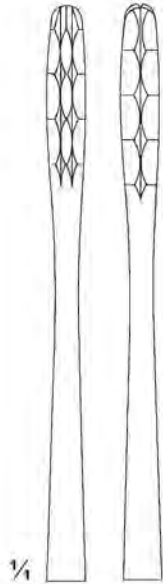

227-01-22  
22 cm / 8¾"

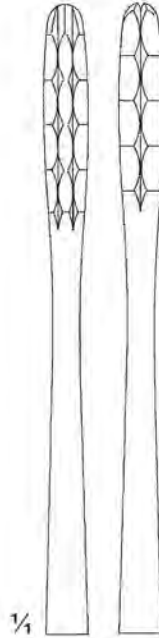

227-02-25  
25 cm / 10"

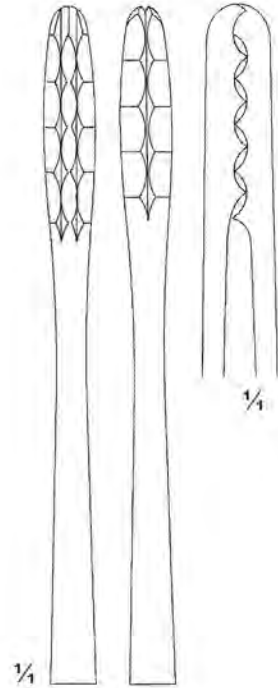

227-03-27  
27 cm / 10¾"

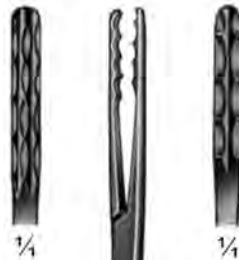

Ulrich  
227-04-18  
18 cm / 7"



Ulrich  
227-05-18  
18 cm / 7"

**Tupferzangen ; Pinzas para tampones  
Dressing Forceps ; Pinze per medicatura  
Pincers à tampons ; Pinças para tampões**



Ulrich  
228-01-22 To 228-03-27



¼  
228-01-22  
22 cm / 8¾"



¼  
228-02-25  
25 cm / 10"

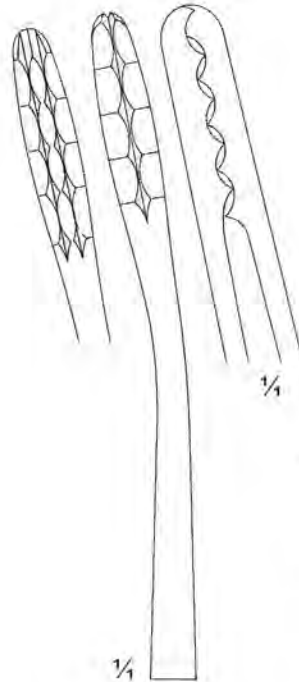

¼  
228-03-27  
27 cm / 10¾"

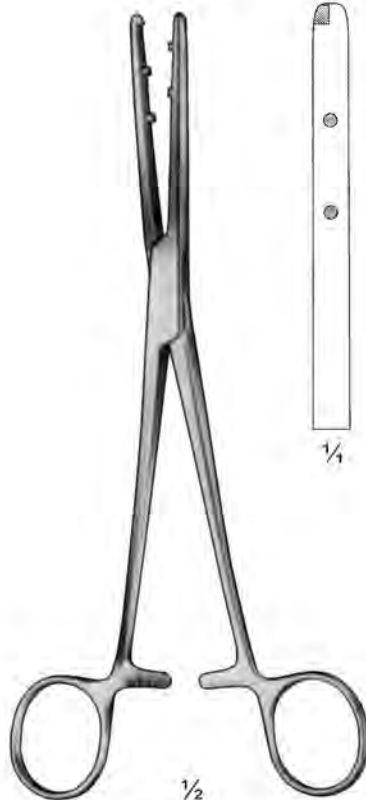

½  
Emmet  
228-04-21  
21 cm / 8¼"



¼



72 mm  
Sauerbruch  
228-05-55  
55 cm / 22"



**Trokare ; Trócares  
Trocars ; Trequarti  
Trocarts ; Trocartes**



Landau  
229-01-16  
16 cm / 6 1/4"  
Ø 2 mm



Landau  
229-02-19  
19 cm / 7 1/2"  
Ø 2 mm

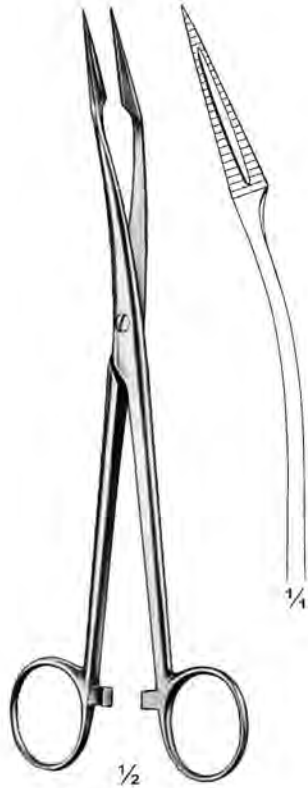

229-03-20  
20 cm / 8"  
Dilation Forceps

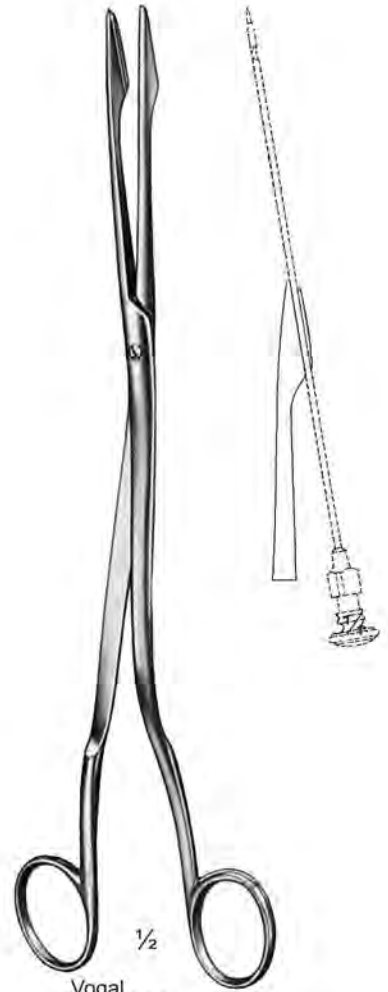

Vogal  
229-04-26  
26 cm / 10 1/4"  
Dilation Forceps



Universal  
229-05-03 Set with 3 tips  
229-06-04 Set with 4 tips  
12.5 cm / 5"

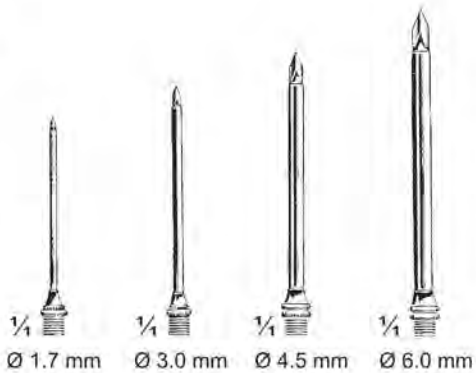

Universal  
229-07-03 Set with 3 tips  
229-08-04 Set with 4 tips  
12.5 cm / 5"

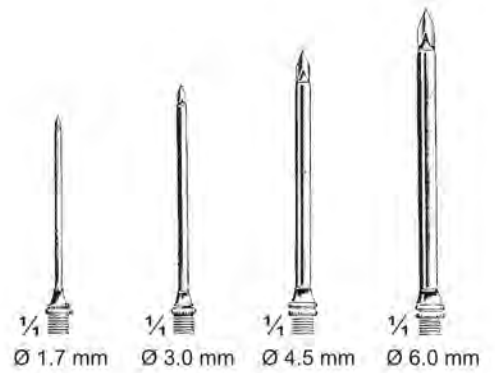

Trokare ; Trócares  
Trocars ; Trequarti  
Trocarts ; Trocartes



1/2

Nelson-Standard  
230-01-03 Ø 3.0 mm  
230-02-03 Ø 3.5 mm  
230-03-04 Ø 4.0 mm  
230-04-04 Ø 4.5 mm  
230-05-05 Ø 5.0 mm  
230-06-05 Ø 5.5 mm  
230-07-06 Ø 6.0 mm  
11 cm / 4 1/4"



1/2

Roberts-Standard  
230-08-03 Ø 3.0 mm  
230-09-03 Ø 3.5 mm  
230-10-04 Ø 4.0 mm  
230-11-04 Ø 4.5 mm  
230-12-05 Ø 5.0 mm  
230-13-05 Ø 5.5 mm  
230-14-06 Ø 6.0 mm  
12 cm / 4 3/4"



1/2

Graefe-Standard  
230-15-03 Ø 3.0 mm  
230-16-03 Ø 3.5 mm  
230-17-04 Ø 4.0 mm  
230-18-04 Ø 4.5 mm  
230-19-05 Ø 5.0 mm  
230-20-05 Ø 5.5 mm  
230-21-06 Ø 6.0 mm  
12 cm / 4 3/4"



1/2

Lichtwitz  
230-22-03  
19 cm / 7 1/2"  
Ø 3.0 mm

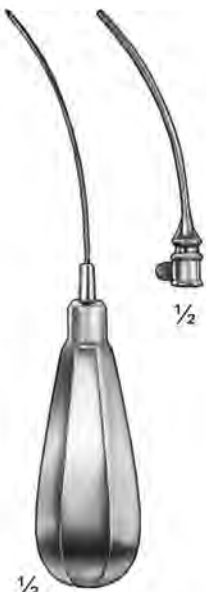

1/2

Lichtwitz  
230-23-02  
15 cm / 6"  
Ø 2.0 mm



1/2

Pierce  
230-24-03 Ø 3.0 mm  
230-25-04 Ø 4.0 mm  
230-26-05 Ø 5.0 mm  
17 cm / 6 3/4"



1/2

Krause  
230-27-03 Ø 3.0 mm  
230-28-04 Ø 4.0 mm  
230-29-05 Ø 5.0 mm  
230-30-05 Ø 5.5 mm  
16 cm / 6 1/4"



1/2

Coakley  
230-31-02  
16 cm / 6 1/4"  
Ø 2.25 mm

**Trokare ; Trócares  
Trocars ; Trequarti  
Trocarts ; Trocartes**

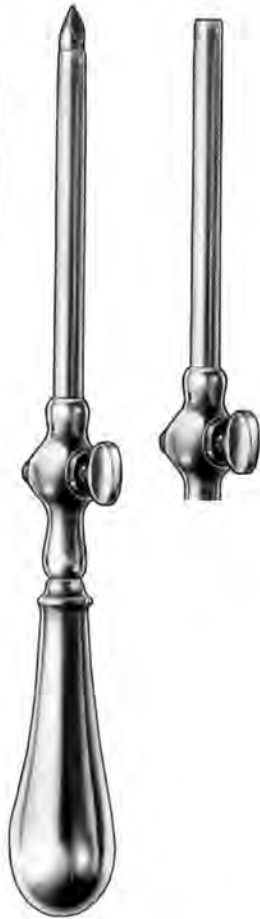

**Buelau**  
231-01-08  
21 cm / 8 1/4"  
Ø 8.0 mm



**Emmet**  
231-02-06 Ø 6.0 mm  
231-03-08 Ø 8.7 mm  
231-04-10 Ø 10.0 mm  
21 cm / 8 1/4"



**Billroth**  
231-05-05 Ø 5.0 mm  
231-06-06 Ø 6.0 mm  
24 cm / 9 1/2"



**Campbell**  
231-07-16  
16.5 cm / 6 1/2"



**Campbell**  
231-08-16  
16.5 cm / 6 1/2"



**Hagedorn**  
231-09-02 Ø 2.0 mm  
231-10-02 Ø 2.5 mm  
10 cm / 4"  
231-11-02 Ø 2.0 mm  
231-12-02 Ø 2.5 mm  
13 cm / 5 1/8"



**Douglas**  
231-13-03  
11.5 cm / 4 1/2"  
Ø 3.0 mm



**Lichtwitz**  
231-14-11  
11 cm / 4 1/4"



**Trokare ; Trócares  
Trocars ; Trequarti  
Trocarts ; Trocartes**

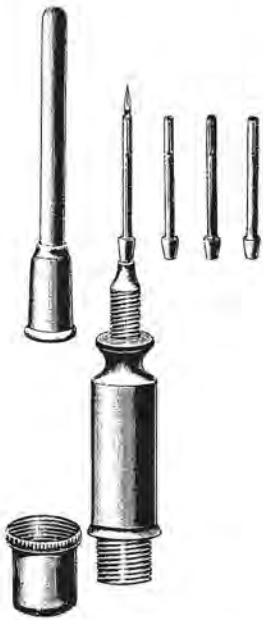

Southey  
232-01-03  
Set of 3 pcs



Lower  
232-02-04 Ø 4.0 mm  
232-03-05 Ø 5.5 mm  
232-04-06 Ø 6.5 mm  
14 cm / 5½"



Pean  
232-05-13  
14 cm / 5½"  
Ø 13.5 mm



Ochsner  
232-06-04 Ø 4.0 mm  
232-07-05 Ø 5.5 mm  
232-08-06 Ø 6.5 mm  
14 cm / 5½"



Ochsner  
232-09-04 Ø 4.0 mm  
232-10-05 Ø 5.5 mm  
232-11-06 Ø 6.5 mm  
14 cm / 5½"



Curshmann  
232-12-02 Ø 2.25 mm  
232-13-02 Ø 2.50 mm  
232-14-02 Ø 2.75 mm  
7 cm / 2¾"

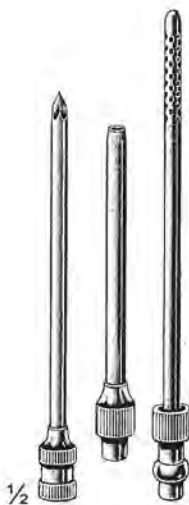

Duke  
232-15-05  
11.5 cm / 4½"  
Ø 5.5 mm



Brich  
232-16-04  
18 cm / 7"  
Ø 4.5 mm



Nelson  
232-17-08 To 232-20-14  
21 cm / 8¼"



232-17-08  
Ø 8 mm



232-18-10  
Ø 10 mm



232-19-12  
Ø 12 mm



232-20-14  
Ø 14 mm

**Trokare ; Trócares  
Trocars ; Trequarti  
Trocarts ; Trocartes**

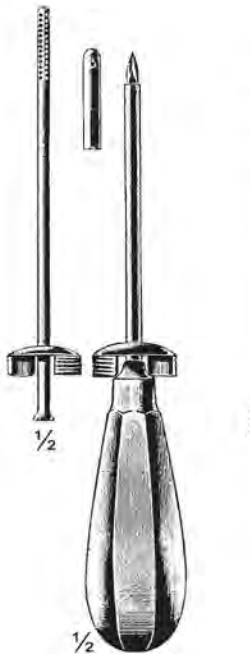

**233-01-13** 1.2 X 80 mm  
13 cm / 5 1/8"  
**233-02-16** 1.5 X 80 mm  
16 cm / 6 1/4"

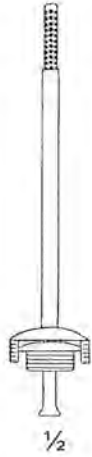

1/2

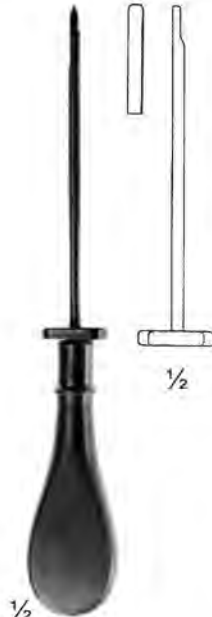

1/2

**233-03-03**  
16 cm / 6 1/4"  
Ø 3.5 mm

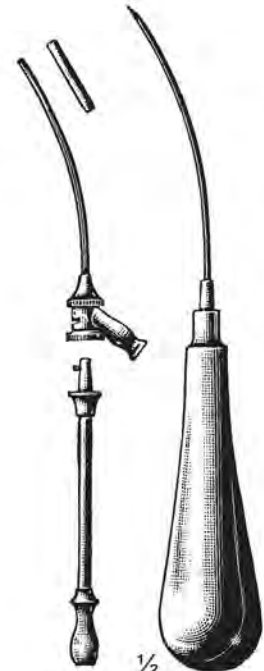

1/2

**Haeggstroem**  
**233-04-02** Ø 2.0 mm  
**233-05-03** Ø 3.5 mm  
18 cm / 7"



**Fleurant**  
**233-06-05**  
23 cm / 9"  
Ø 5.0 mm



**Fleurant**  
**233-07-05**  
23 cm / 9"  
Ø 5.0 mm

1/2



1/2

**Douglas**  
**233-08-10**  
27 cm / 10 1/2"  
Ø 10 mm



**Fleurant**  
**233-09-05**  
23 cm / 9"  
Ø 5.0 mm



**Sauger, Saugrohre ; Tubos de aspiración  
Suction Tubes ; Tubi per aspirazione  
Tubes d'aspiration ; Mangueiras para sucção, Aspiradores**

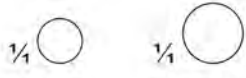

**234-01-06**  
Ø 6 mm

**234-02-08**  
Ø 8 mm

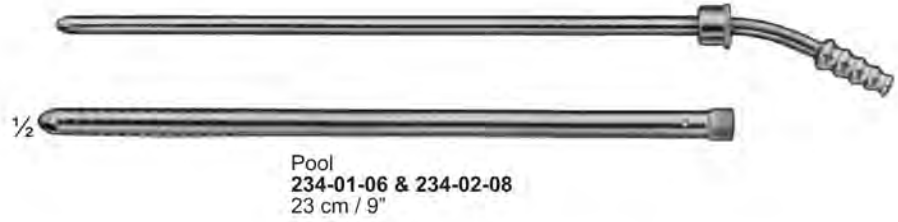

Pool  
**234-01-06 & 234-02-08**  
23 cm / 9"

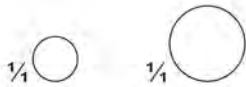

**234-03-06**  
Ø 6 mm

**234-04-10**  
Ø 10 mm

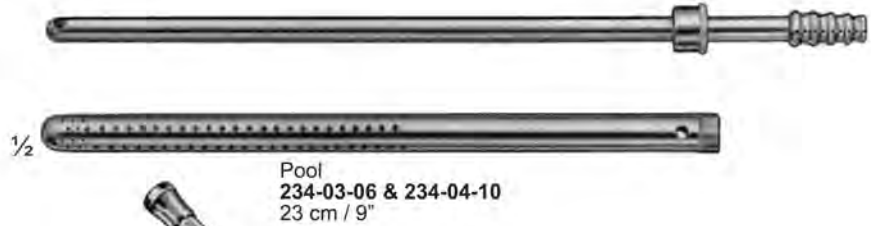

Pool  
**234-03-06 & 234-04-10**  
23 cm / 9"



**Yankauer**  
**234-05-28**  
28.5 cm / 11¼"  
Olive Ø 7-9 mm



**Yankauer**  
**234-06-28**  
28.5 cm / 11¼"  
Olive Ø 7-9 mm



**Yankauer**  
**234-07-29**  
29 cm / 11½"



**Andrews-Pynchon**  
**234-08-24**  
24 cm / 9½"



**De Bakey**  
**234-09-27**  
27 cm / 10¾"  
Olive Ø 6-10 mm

**Sauger, Saugrohre ; Tubos de aspiración  
Suction Tubes ; Tubi per aspirazione  
Tubes d'aspiration ; Mangueiras para sucção, Aspiradores**



**Adson**  
235-01-04  
19 cm / 7 1/2"  
Ø 4 mm



**Adson**  
235-02-04  
21 cm / 8 1/4"  
Ø 4 mm



**Frazier (Fergusson)**  
235-03-02 Ø 2.0 mm  
235-04-02 Ø 2.5 mm  
235-05-03 Ø 3.0 mm  
235-06-04 Ø 4.0 mm  
18 cm / 7"



**Poppen**  
235-07-02 Ø 2.0 mm  
235-08-02 Ø 2.5 mm  
235-09-03 Ø 3.0 mm  
235-10-04 Ø 4.0 mm  
13 cm / 5 1/8"



**Poppen**  
235-11-02 Ø 2.5 mm  
235-12-03 Ø 3.0 mm  
13 cm / 5 1/8"



**De Bakey**  
235-13-27  
27 cm / 10 3/4"  
Olive Ø 9 mm



**De Bakey**  
235-14-16  
16 cm / 6 1/4"  
Olive Ø 9 mm



**Seiffert**  
235-15-12  
12.5 cm / 5"



**Frazier**  
235-16-03 Ø 3.0 mm  
235-17-05 Ø 5.0 mm  
18 cm / 7"  
Olive Ø 6-9 mm



**Fergusson**  
235-18-02 Ø 2.0 mm  
235-19-03 Ø 3.0 mm  
235-20-04 Ø 4.0 mm  
235-21-05 Ø 5.0 mm  
18 cm / 7"  
Olive Ø 6-9 mm



**Fergusson**  
235-22-04 Ø 4.0 mm  
18 cm / 7"  
Olive Ø 6-9 mm

**Sauger, Saugrohre ; Tubos de aspiración  
Suction Tubes ; Tubi per aspirazione  
Tubes d'aspiration ; Mangueiras para sucção, Aspiradores**

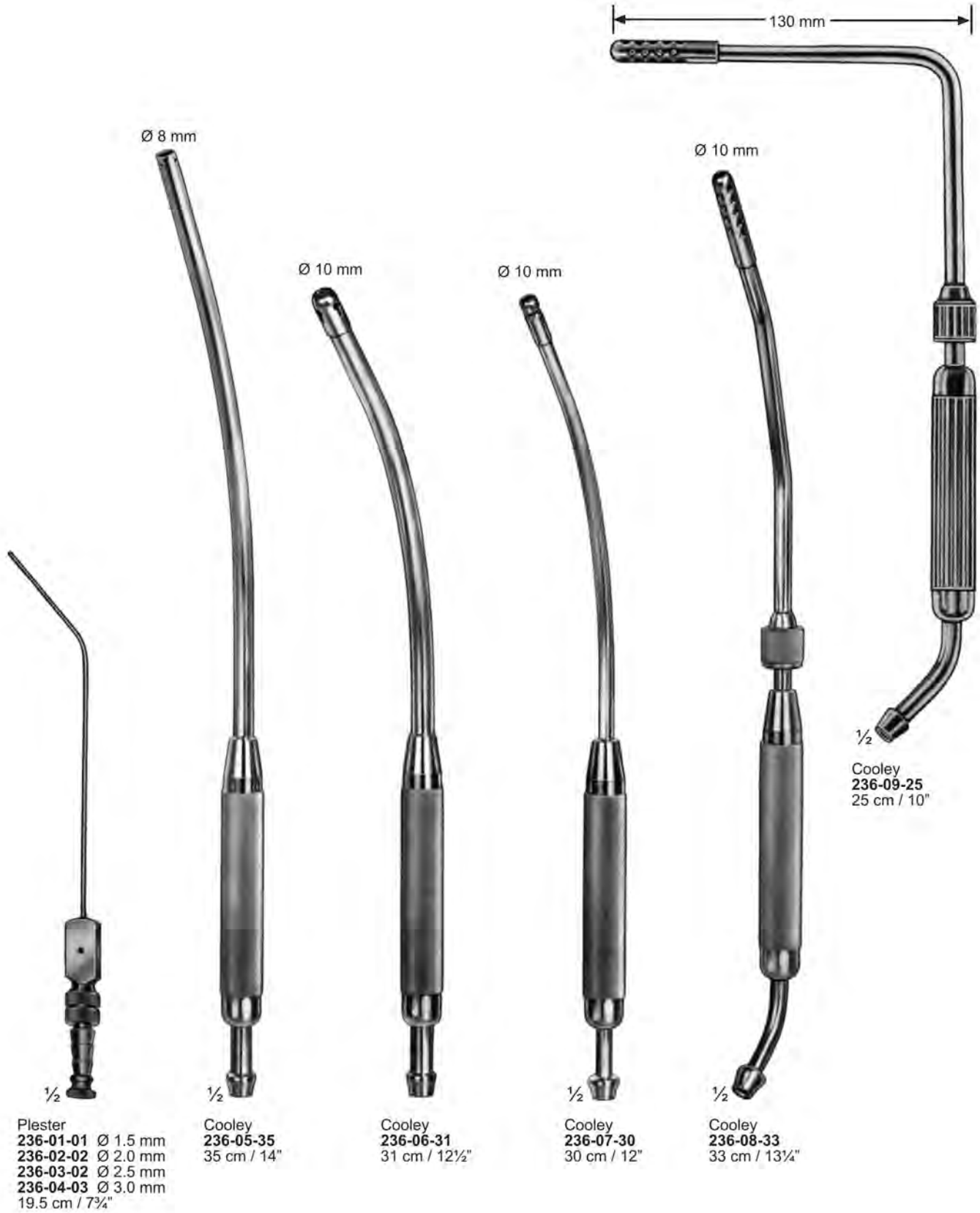

**Sauger, Saugrohre ; Tubos de aspiración  
Suction Tubes ; Tubi per aspirazione  
Tubes d'aspiration ; Mangueiras para sucção, Aspiradores**



Wullstein  
237-01-04 To 237-03-08  
14 cm / 5½"  
237-04-00  
Micro suction tube with lower hub and  
3 suction cannulas 237-01-04 To 237-03-08

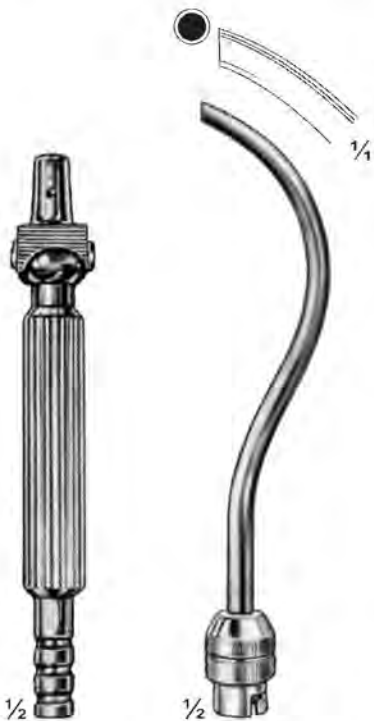

237-10-16  
16 cm / 6¼"  
Suction handle



237-11-16  
16.5 cm / 6½"

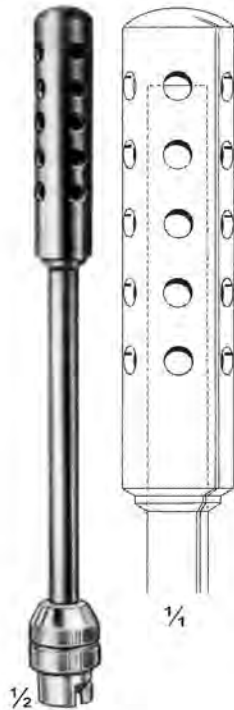

237-12-18  
18.5 cm / 7¼"



237-13-19  
19 cm / 7½"



237-14-23  
23 cm / 9"



237-15-19  
19 cm / 7½"

**Sauger, Saugrohre ; Tubos de aspiración  
Suction Tubes ; Tubi per aspirazione  
Tubes d'aspiration ; Mangueiras para sucção, Aspiradores**





**Sauger, Saugrohre ; Tubos de aspiración  
Suction Tubes ; Tubi per aspirazione  
Tubes d'aspiration ; Mangueiras para sucção, Aspiradores**

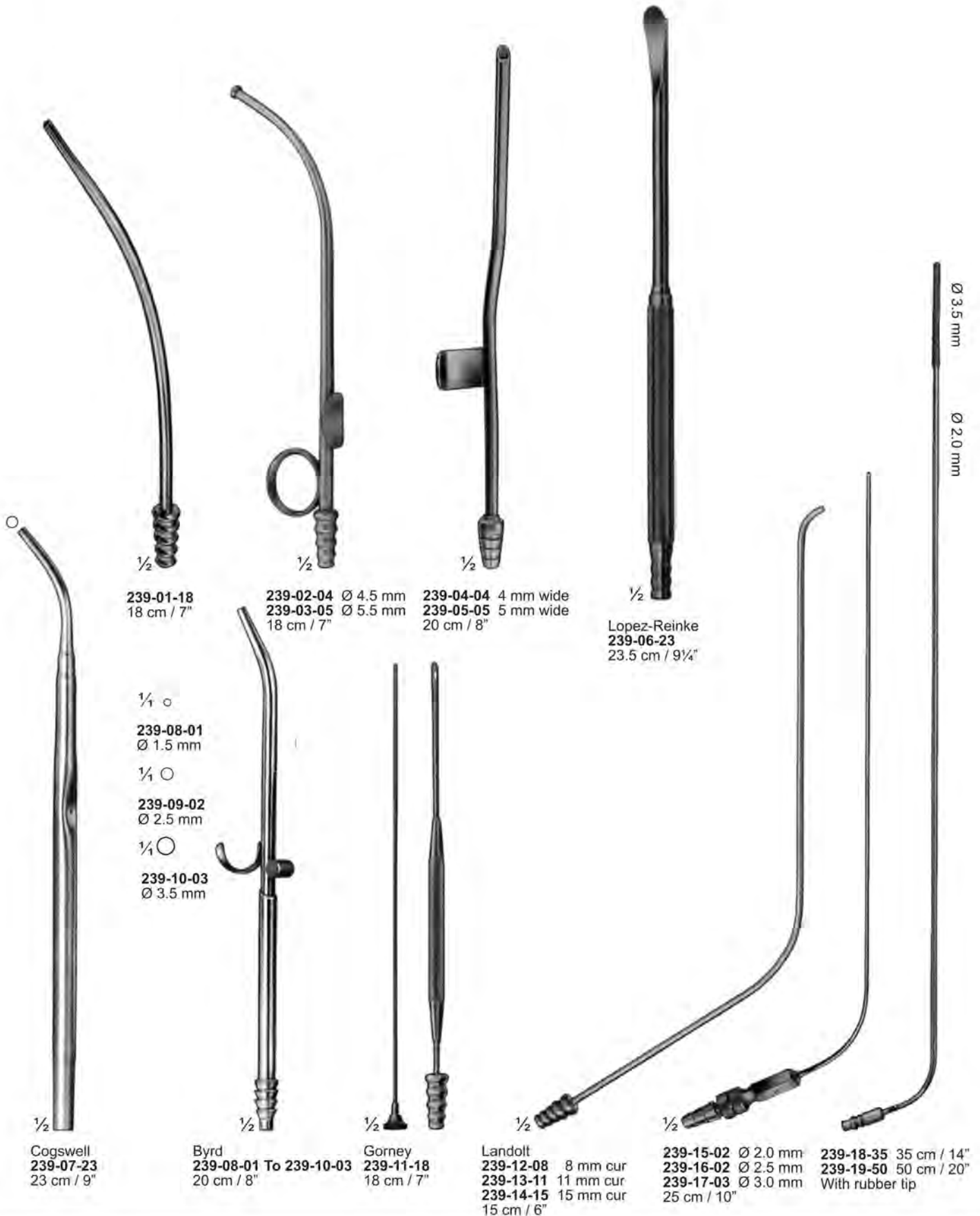

**239-01-18**  
18 cm / 7"

**239-02-04** Ø 4.5 mm  
**239-03-05** Ø 5.5 mm  
18 cm / 7"

**239-04-04** 4 mm wide  
**239-05-05** 5 mm wide  
20 cm / 8"

**Lopez-Reinke**  
**239-06-23**  
23.5 cm / 9 1/4"

1/4" Ø  
**239-08-01**  
Ø 1.5 mm

1/4" Ø  
**239-09-02**  
Ø 2.5 mm

1/4" Ø  
**239-10-03**  
Ø 3.5 mm

1/2"  
**Cogswell**  
**239-07-23**  
23 cm / 9"

1/2"  
**Byrd**  
**239-08-01 To 239-10-03**  
20 cm / 8"

1/2"  
**Gorney**  
**239-11-18**  
18 cm / 7"

1/2"  
**Landolt**  
**239-12-08** 8 mm cur  
**239-13-11** 11 mm cur  
**239-14-15** 15 mm cur  
15 cm / 6"

1/2"  
**239-15-02** Ø 2.0 mm  
**239-16-02** Ø 2.5 mm  
**239-17-03** Ø 3.0 mm  
25 cm / 10"  
**239-18-35** 35 cm / 14"  
**239-19-50** 50 cm / 20"  
With rubber tip

Ø 3.5 mm  
Ø 2.0 mm





**Sauger, Saugrohre ; Tubos de aspiración  
Suction Tubes ; Tubi per aspirazione  
Tubes d'aspiration ; Mangueiras para sucção, Aspiradores**



240-01-02 Ø 2.0 mm  
240-02-02 Ø 2.5 mm  
10 cm / 4"  
Silver plated



Seiffert  
240-03-12  
12.5 cm / 5"



240-04-02 Ø 2.0 mm  
240-05-02 Ø 2.5 mm  
17 cm / 6 3/4"



240-06-22  
150 mm X 1.5 mm



240-07-22  
150 mm X 2.0 mm



240-08-22  
150 mm X 2.5 mm



240-09-22  
150 mm X 3.5 mm

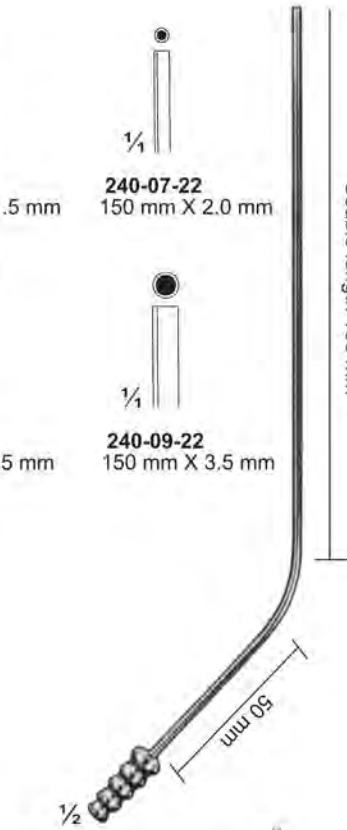

Yasargil  
240-06-22 To 240-09-22  
22 cm / 8 3/4"  
Olive Ø 6.5-9 mm



Klima-Rosegger  
240-10-09  
9 cm / 3"  
1.80 X 35 mm

Strauss  
240-11-06 1.00 X 40 mm  
240-12-06 1.20 X 40 mm  
240-13-06 1.40 X 40 mm  
6.5 cm / 2 1/2"

Dattner  
240-14-11  
11 cm / 4 1/4"  
0.9 X 65 mm

240-15-16 1.40 mm  
240-16-16 1.80 mm  
16.5 cm / 6 1/2"

**Nadelhalter ; Porta-Agujas  
Needle Holders ; Port Aghi  
Porte-aiguilles ; Porta agulhas**

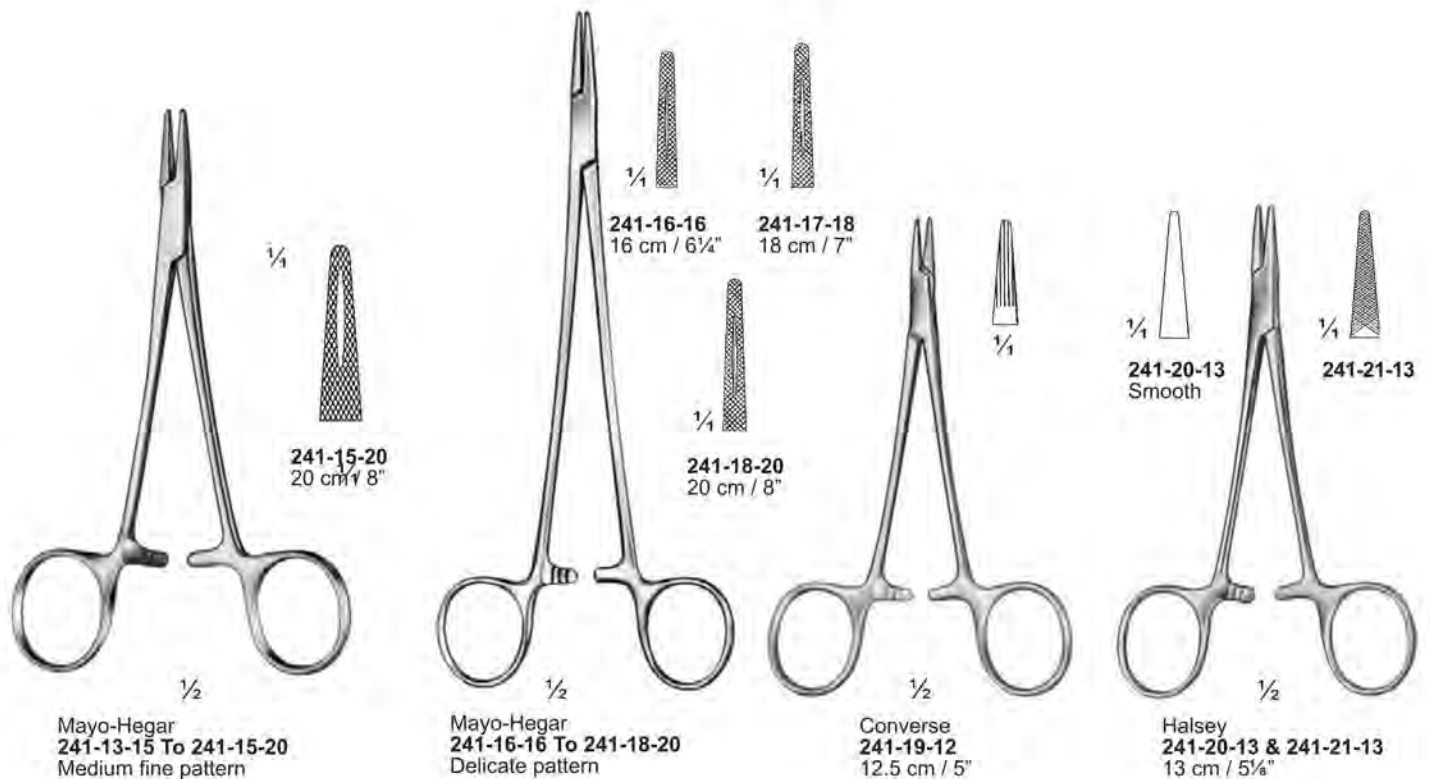

**Nadelhalter ; Porta-Agujas  
Needle Holders ; Port Aghi  
Porte-aiguilles ; Porta agulhas**



$\frac{1}{2}$   
Doyen  
242-01-12  
12.5 cm / 5"

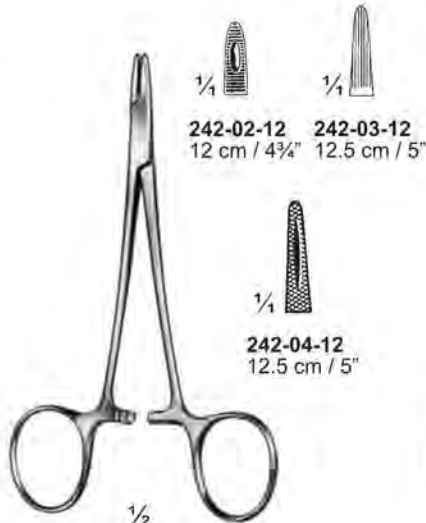

$\frac{1}{2}$   
Derf  
242-02 To 242-04

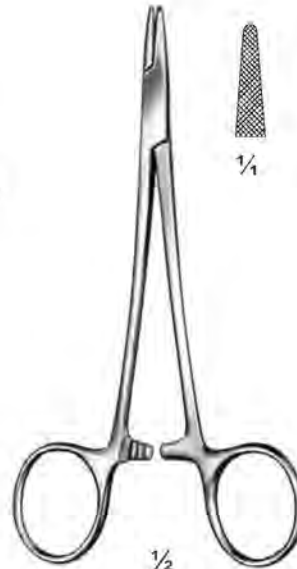

$\frac{1}{2}$   
Hegar-Baumgartner  
242-05-14  
14 cm / 5½"

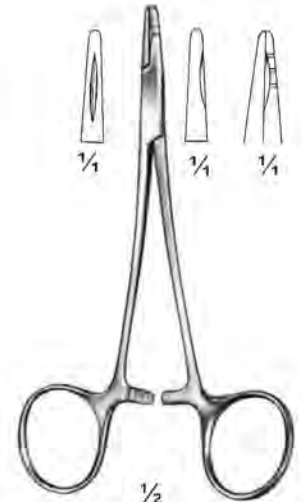

$\frac{1}{2}$   
Neivert  
242-06-13  
13 cm / 5¼"

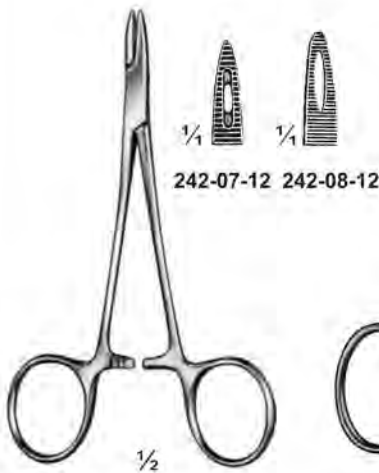

$\frac{1}{2}$   
Collier  
242-07-12 & 242-08-12  
12.5 cm / 5"



$\frac{1}{2}$   
Rehbein-Baby  
242-09-11 11.5 cm / 4½"  
242-10-14 14 cm / 5½"



Kilner  
242-11-13 13 cm / 5¼"  
242-12-15 15 cm / 6"  
242-13-18 18 cm / 7"

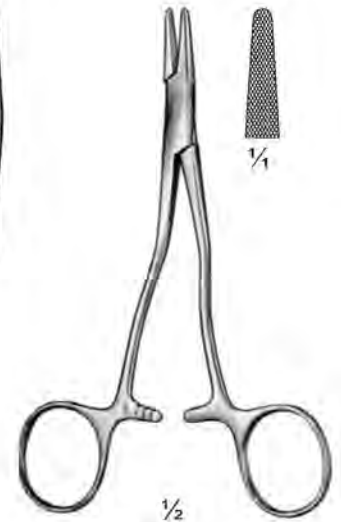

$\frac{1}{2}$   
Kilner  
242-14-13  
13.5 cm / 5¼"

**Nadelhalter ; Porta-Agujas  
Needle Holders ; Port Aghi  
Porte-aiguilles ; Porta agulhas**



Crile-Wood  
243-01-15 To 243-05-23

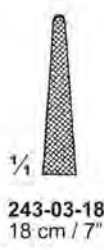
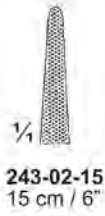
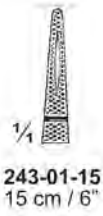

Crile-Murray  
243-06-15  
15 cm / 6"

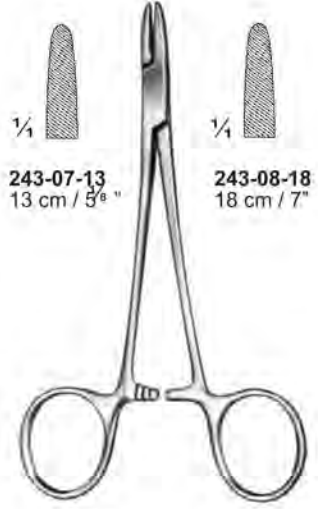

Brown  
243-07-13 & 243-08-18

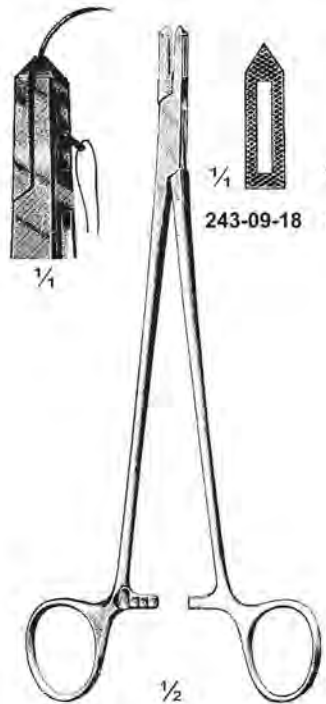
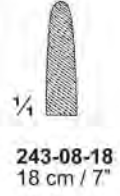
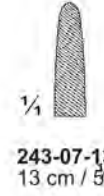

Hodlick  
243-09-18 & 243-10-18  
18 cm / 7"

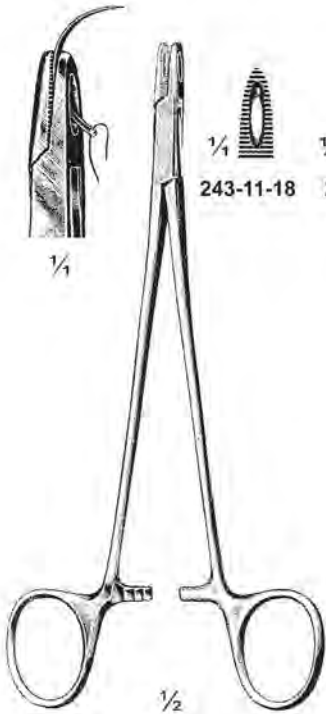

Adson  
243-11-18 & 243-12-18  
18 cm / 7"

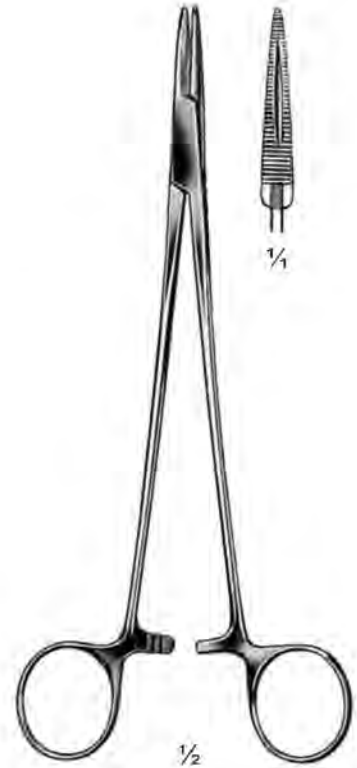

Mayo-Hegar Seeley  
243-13-20  
20 cm / 8"



**Nadelhalter ; Porta-Agujas  
Needle Holders ; Port Aghi  
Porte-aiguilles ; Porta agulhas**



Jamison  
244-01-23 To 244-03-23  
23.5 cm / 9 1/4"

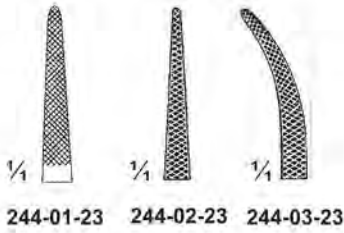

Sart  
244-04-18 18 cm / 7"  
244-05-26 26 cm / 10 1/4"



Hegar  
244-06-17 To 244-09-20

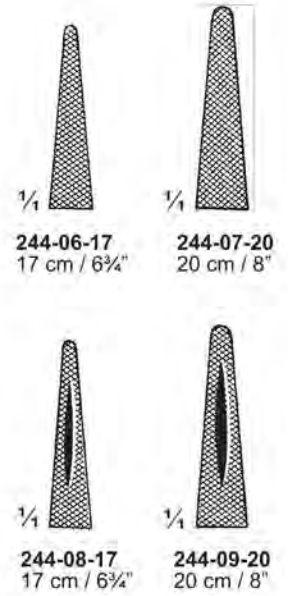

M.G.H.  
(Mass-General-Hospital)  
244-10-17  
17 cm / 6 3/4"



Hegar  
244-11-20 To 244-14-24

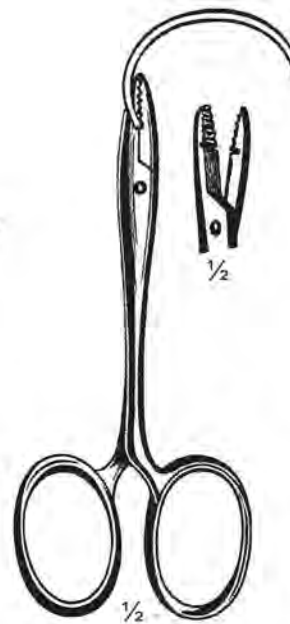
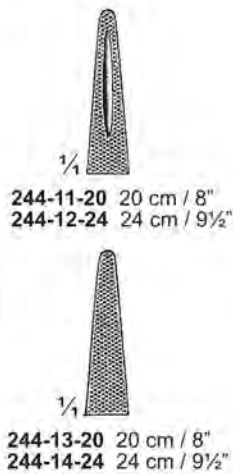

Bruce Clark  
244-15-12 12.5 cm / 5"  
244-16-14 14 cm / 5 1/2"

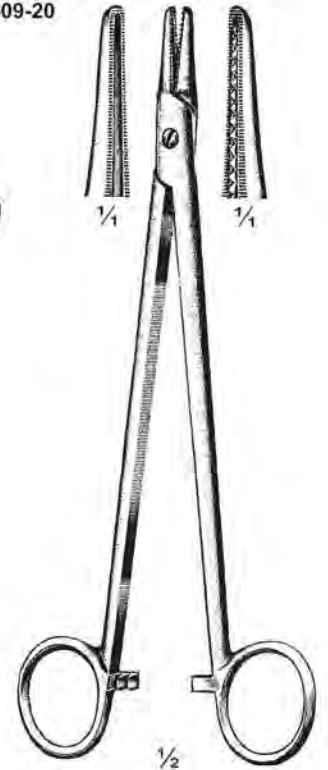

Hegar  
244-17-20  
20 cm / 8"



**Nadelhalter ; Porta-Agujas  
Needle Holders ; Port Aghi  
Porte-aiguilles ; Porta agulhas**

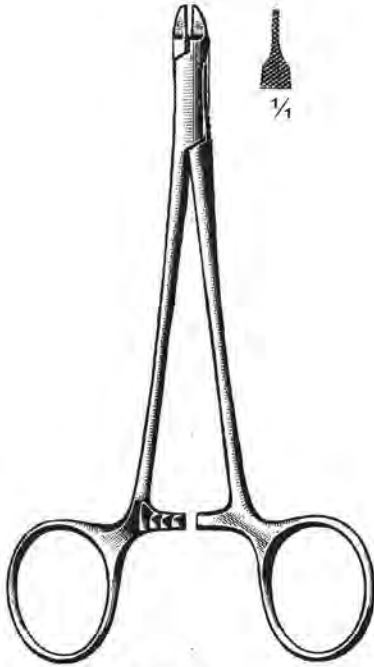

Hufnagel  
245-01-14  
14 cm / 5½"



1/2  
245-02-18 18 cm / 7"  
245-03-21 21 cm / 8¼"  
245-04-24 24 cm / 9½"  
245-05-26 26 cm / 10¼"

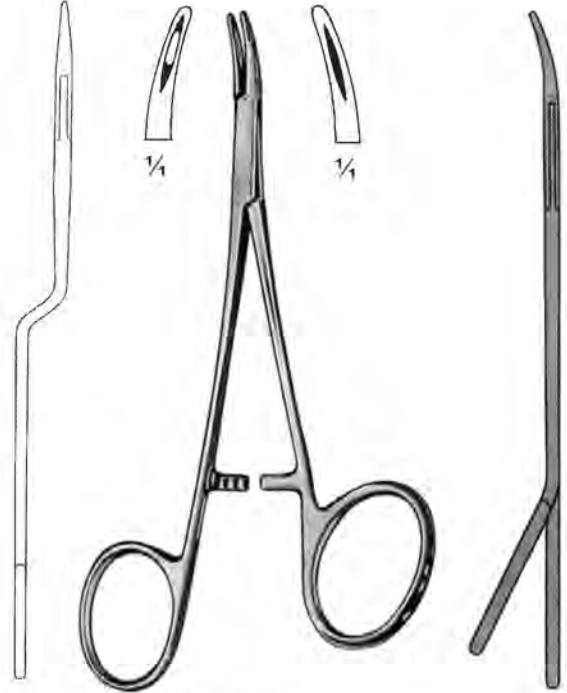

Converse  
245-06-15  
15 cm / 6"



1/2  
Wertheim  
245-07-20 20 cm / 8"  
245-08-24 24 cm / 9½"



1/2  
Stratte  
245-09-20 20 cm / 8"  
245-10-24 24 cm / 9½"

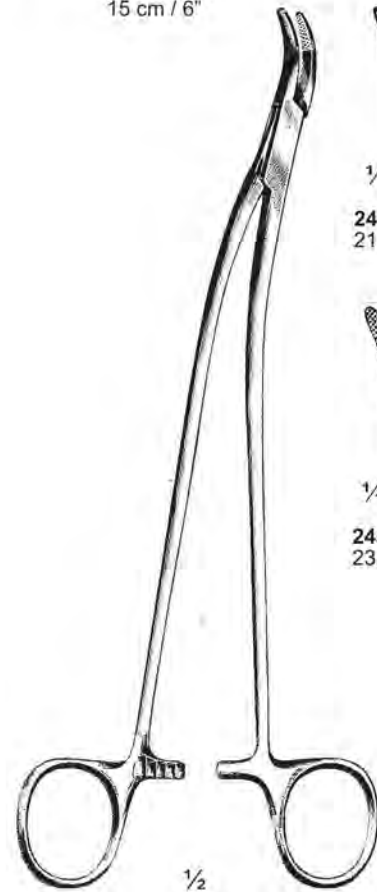

1/2  
Stratte  
245-11-21 & 245-12-23



1/4  
245-11-21  
21 cm / 8¼"



1/4  
245-12-23  
23.5 cm / 9¼"

**Nadelhalter ; Porta-Agujas  
Needle Holders ; Port Aghi  
Porte-aiguilles ; Porta agulhas**



246-01-17

246-02-17

Senning  
246-01-17 & 246-02-17  
17 cm / 6 3/4"

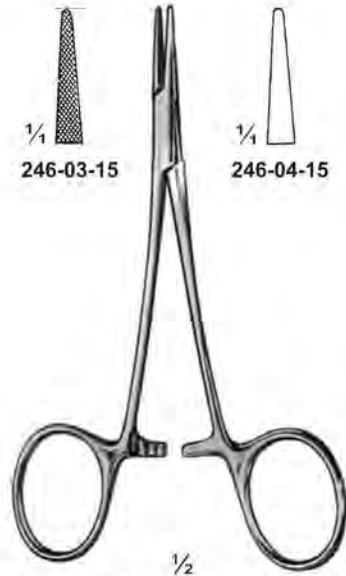

246-03-15

246-04-15

Halstead  
246-03-15 & 246-04-15  
15 cm / 6"



246-05-26  
26.5 cm / 10 1/2"

246-06-28  
28 cm / 11"

Masson  
246-05-26 & 246-06-28

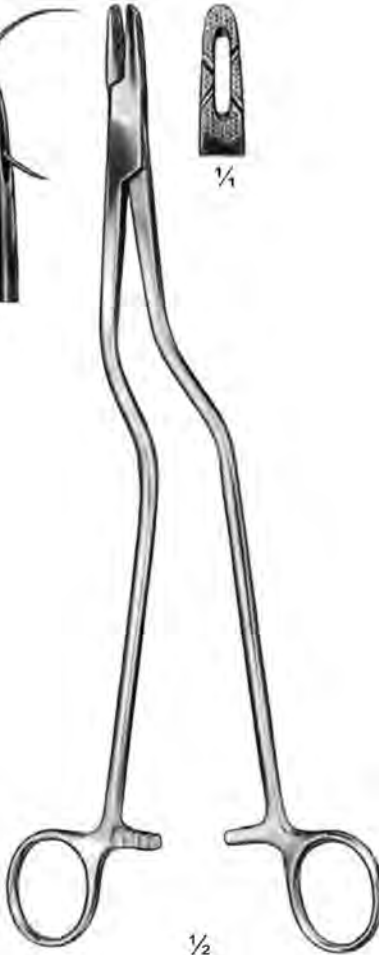

Masson-Luethy  
246-07-25 25 cm / 10"  
246-08-27 27 cm / 10 1/2"

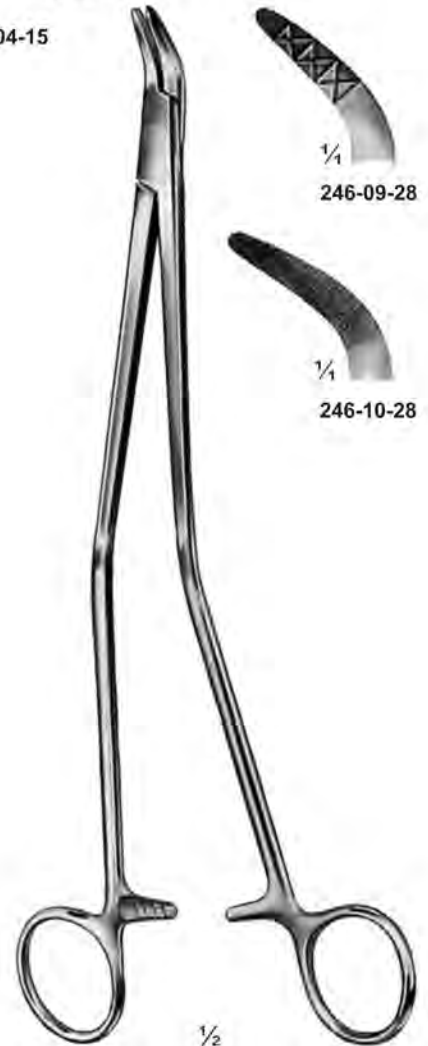

Janson  
246-09-28 & 246-10-28  
28 cm / 11"



**Nadelhalter ; Porta-Agujas  
Needle Holders ; Port Aghi  
Porte-aiguilles ; Porta agulhas**



$\frac{1}{4}$   
**247-01-27**  
27 cm / 10½"



$\frac{1}{4}$   
**247-02-27**  
27 cm / 10½"

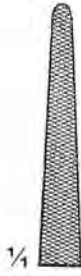

$\frac{1}{4}$   
**247-03-28**  
28 cm / 11"

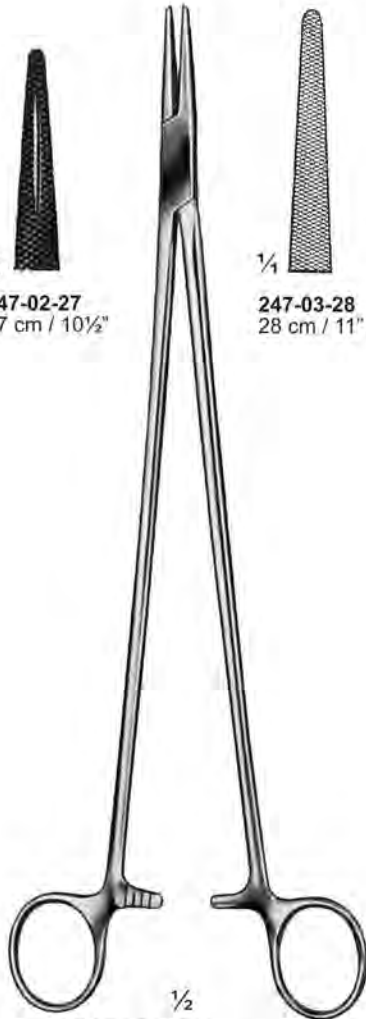

$\frac{1}{2}$   
Wangensteen  
**247-01-27 To 247-03-28**



$\frac{1}{2}$   
Finochietto  
**247-04-27**  
27 cm / 10½"

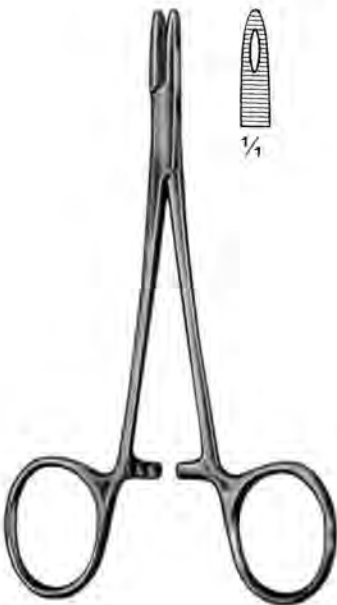

Collier  
**247-05-13**  
13 cm / 5¼"

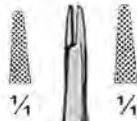

Swiss Mod.  
**247-06-14** 14.5 cm / 5¾"  
**247-07-17** 17 cm / 6¾"



$\frac{1}{4}$   
**247-08-18**  
18 cm / 7"



$\frac{1}{4}$   
**247-09-27**  
27 cm / 10½"

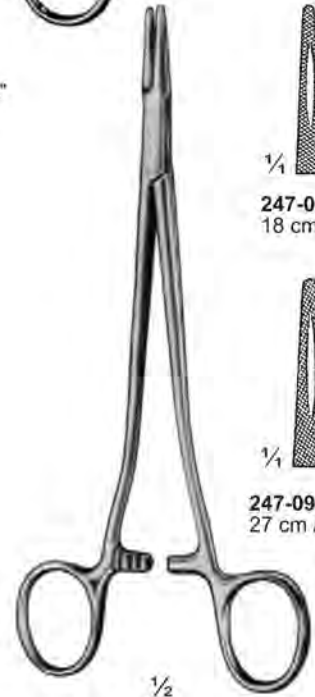

Sarot  
**247-08-18 & 247-09-27**



**Nadelhalter ; Porta-Agujas  
Needle Holders ; Port Aghi  
Porte-aiguilles ; Porta agulhas**

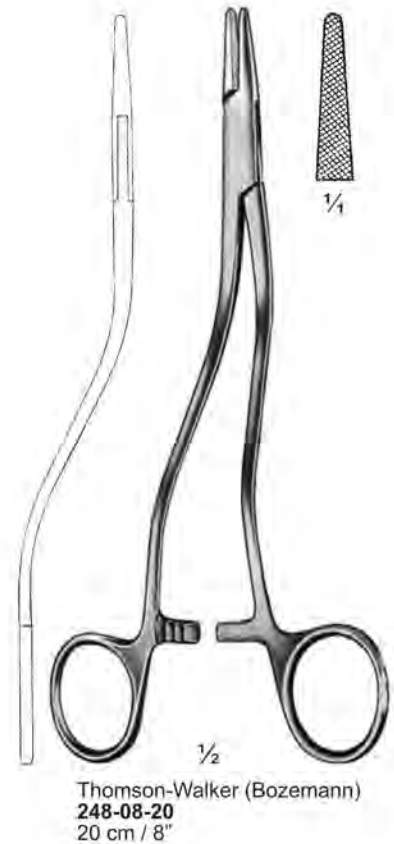
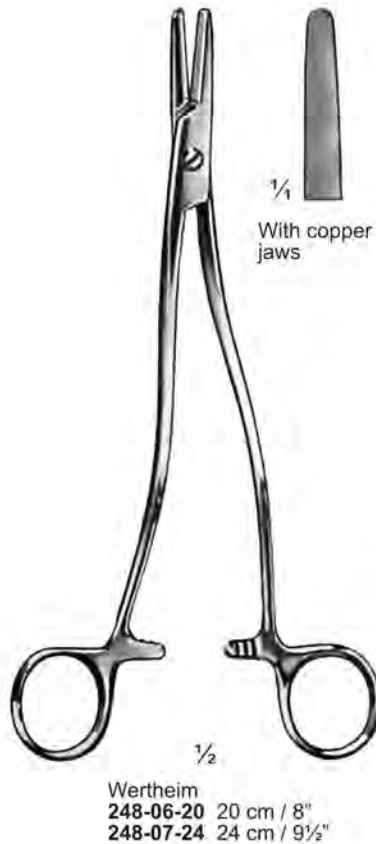
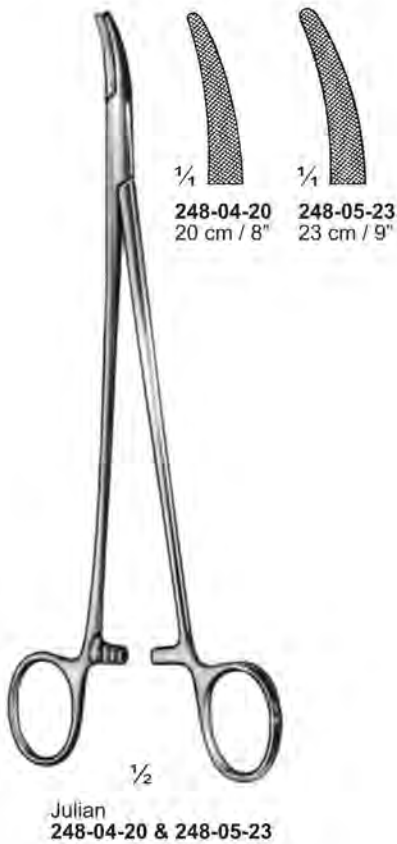

**Nadelhalter ; Porta-Agujas  
Needle Holders ; Port Aghi  
Porte-aiguilles ; Porta agulhas**



Olsen-Hegar  
249-01-12 & 249-02-12  
12 cm / 4 3/4"

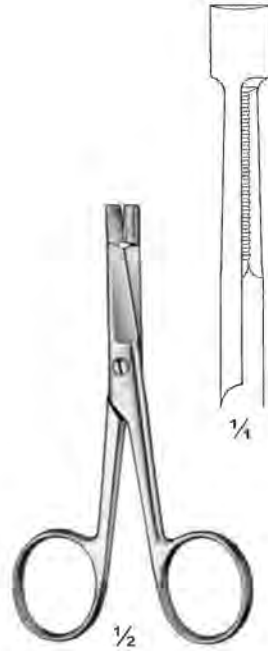

Eiselsberg  
249-03-11  
11.5 cm / 4 1/2"



Bozemann  
249-04-20  
20 cm / 8"

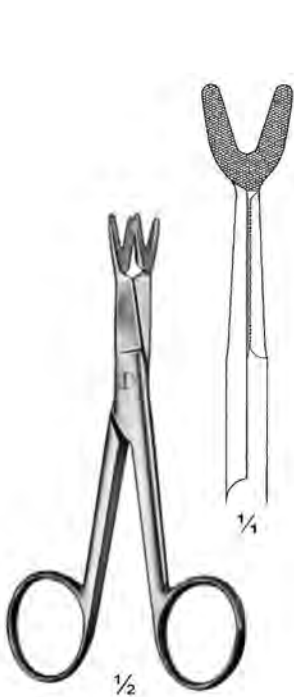

Schoemaker-Loth  
249-05-12  
12.5 cm / 5"

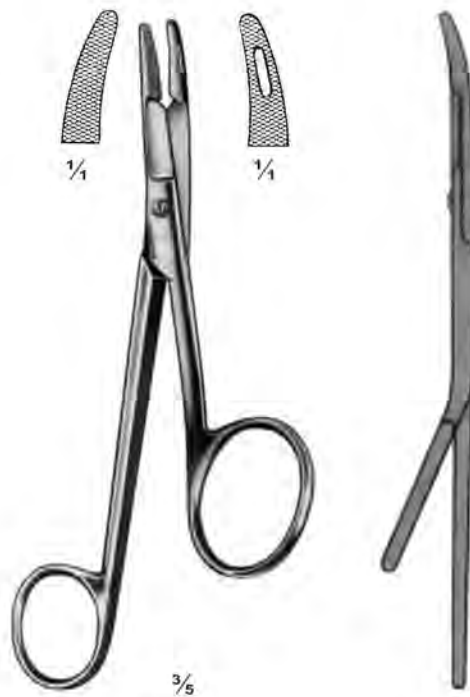

Gillies  
249-06-15  
15.5 cm / 6 1/4"

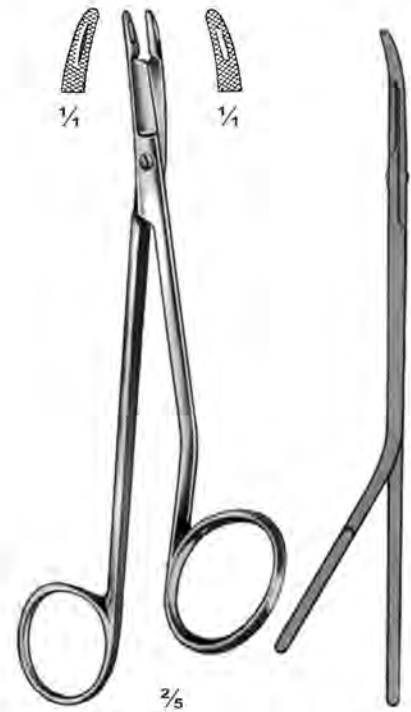

Gillies-Slim  
249-07-14  
14.5 cm / 5 3/4"

**Nadelhalter ; Porta-Agujas  
Needle Holders ; Port Aghi  
Porte-aiguilles ; Porta agulhas**

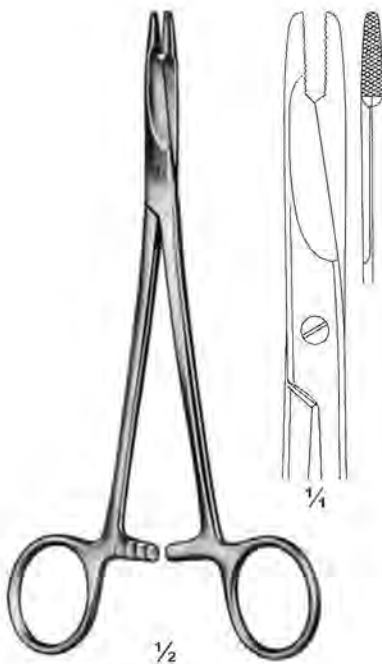

$\frac{1}{2}$   
Olsen-Hegar  
250-01-17  
17 cm / 6 $\frac{3}{4}$ "



$\frac{1}{2}$   
Olsen-Hegar  
250-02-14 & 250-03-18

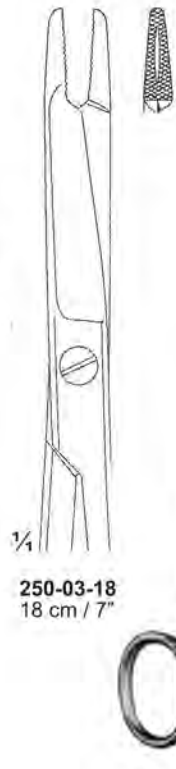

$\frac{1}{4}$   
250-03-18  
18 cm / 7"



$\frac{1}{2}$   
Olsen-Hegar  
250-04-14 To 250-06-19

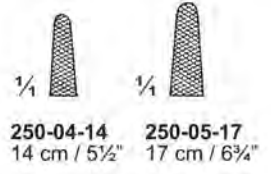

$\frac{1}{4}$   $\frac{1}{4}$   
250-04-14 250-05-17  
14 cm / 5 $\frac{1}{2}$ " 17 cm / 6 $\frac{3}{4}$ "

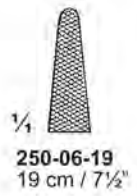

$\frac{1}{4}$   
250-06-19  
19 cm / 7 $\frac{1}{2}$ "

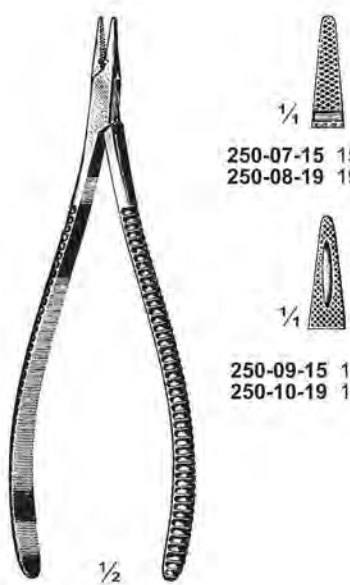

$\frac{1}{2}$   
Crile  
250-07-15 To 250-10-19

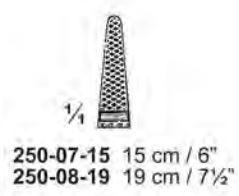

$\frac{1}{4}$   
250-07-15 15 cm / 6"  
250-08-19 19 cm / 7 $\frac{1}{2}$ "

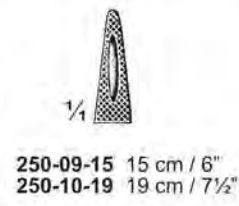

$\frac{1}{4}$   
250-09-15 15 cm / 6"  
250-10-19 19 cm / 7 $\frac{1}{2}$ "



$\frac{1}{2}$   
Kirschner  
250-11-18 To 250-13-23

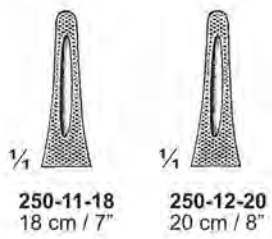

$\frac{1}{4}$   $\frac{1}{4}$   
250-11-18 18 cm / 7"  
250-12-20 20 cm / 8"

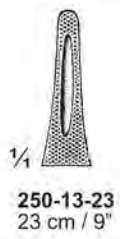

$\frac{1}{4}$   
250-13-23  
23 cm / 9"



$\frac{1}{2}$   
Axhausen  
250-14-18 18.5 cm / 7 $\frac{1}{4}$ "  
250-15-23 23 cm / 9"

Nadelhalter ; Porta-Agujas  
Needle Holders ; Port Aghi  
Porte-aiguilles ; Porta agulhas



Toennis  
251-01-18 & 251-02-18  
18 cm / 7"



Toennis  
251-03-18 & 251-04-18  
18 cm / 7"

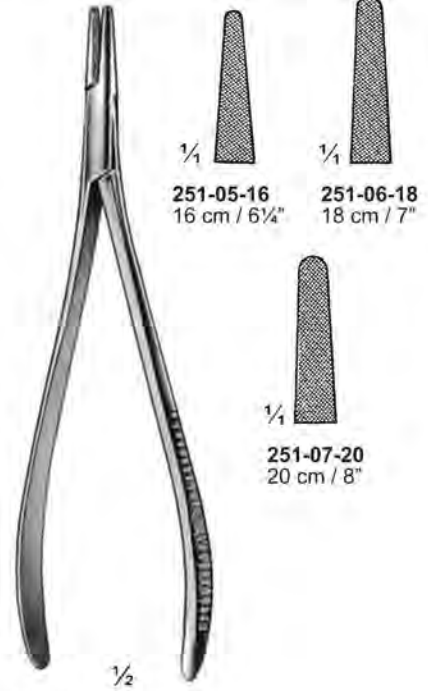

Langenbeck  
251-05-16 To 251-07-20

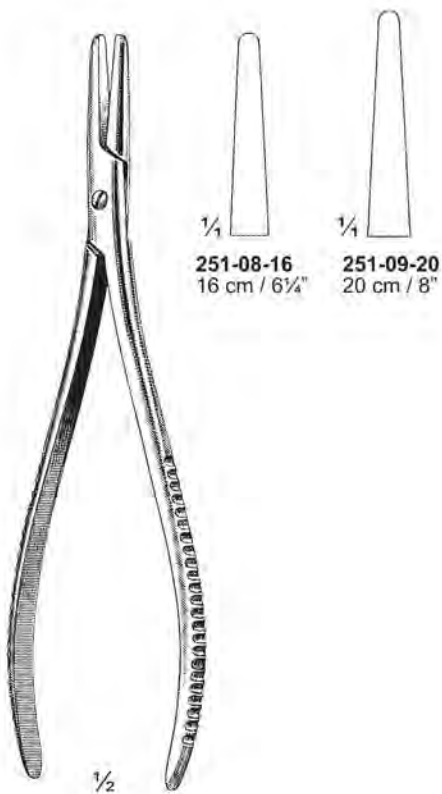

Langenbeck  
251-08-16 & 251-09-20



Koenig  
251-10-17 17 cm / 6 3/4"  
251-11-20 20 cm / 8"

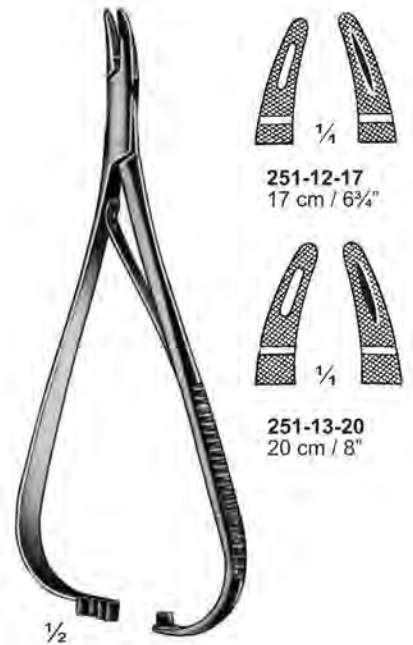

Metzenbaum-Mathieu  
251-12-17 & 251-13-20

**Nadelhalter ; Porta-Agujas  
Needle Holders ; Port Aghi  
Porte-aiguilles ; Porta agulhas**

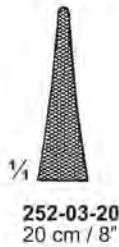
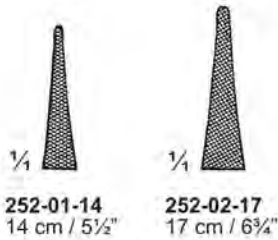

1/2  
Mathieu-Kocher  
252-01-14 To 252-03-20

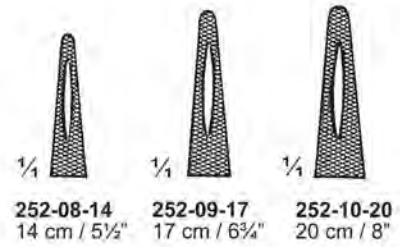
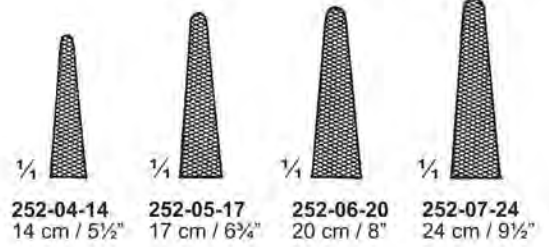

1/2  
Mathieu  
252-04-14 To 252-10-20

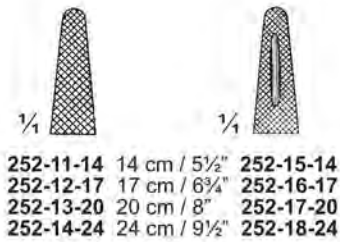

1/2  
Mathieu  
252-11-14 To 252-18-24

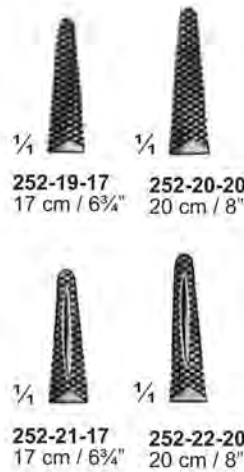

1/2  
Mathieu  
252-19-17 To 252-22-20

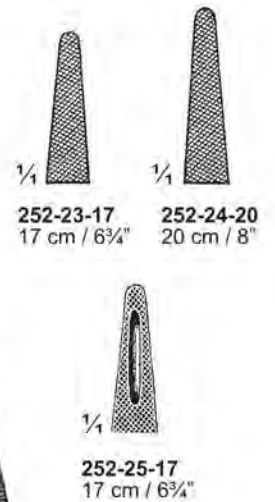

1/2  
Mathieu  
252-23-17 To 252-25-17

**Nadelhalter ; Porta-Agujas  
Needle Holders ; Port Aghi  
Porte-aiguilles ; Porta agulhas**

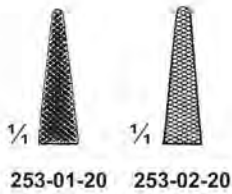

253-01-20 253-02-20

1/2  
Lichtenberg  
253-01-20 & 253-02-20  
20 cm / 8"

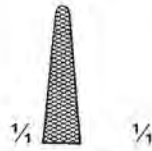

253-03-20 253-04-25  
20 cm / 8" 25 cm / 10"

1/2  
Lichtenberg  
253-03-20 & 253-04-25



1/2  
Mathieu-Sverige  
253-05-17  
17 cm / 6 3/4"



1/2  
Mathieu-Kersten  
253-06-17 17 cm / 6 3/4"  
253-07-20 20 cm / 8"



1/2  
Mathieu-Kersten  
253-08-17 17 cm / 6 3/4"  
253-09-20 20 cm / 8"

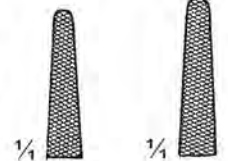

253-10-20 20 cm / 8" 253-11-23 23 cm / 9"

1/2  
Zweifel  
253-10-20 & 253-11-23

**Nadelhalter ; Porta-Agujas  
Needle Holders ; Port Aghi  
Porte-aiguilles ; Porta agulhas**

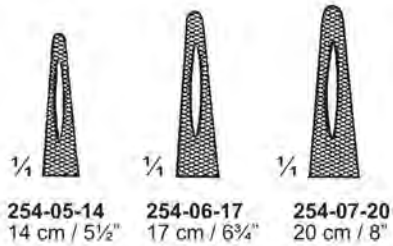
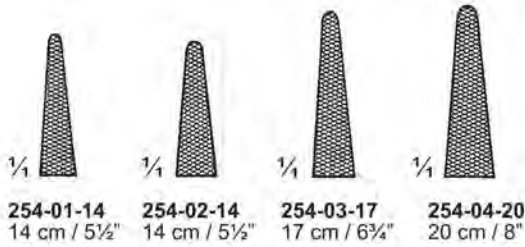

1/2  
Mathieu  
254-01-14 To 254-07-20

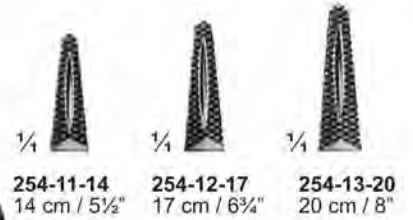

1/2  
Mathieu  
254-08-14 To 254-13-20

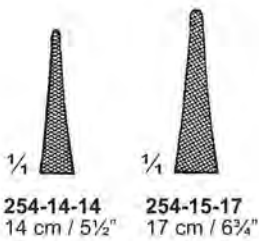

1/2  
Mathieu-Kocher  
254-14-14 To 254-16-20

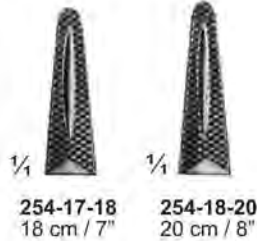

1/2  
Mathieu-Stille  
254-17-18 & 254-18-20

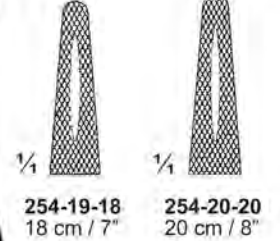

1/2  
Mathieu-Stille  
254-19-18 & 254-20-20  
Very heavy model

**Nadelhalter ; Porta-Agujas  
Needle Holders ; Port Aghi  
Porte-aiguilles ; Porta agulhas**



1/2  
Stille  
255-01-18 18 cm / 7"  
255-02-20 20 cm / 8"



1/2  
Rinne  
255-03-17 To 255-06-20



255-03-17 17 cm / 6 3/4"  
255-04-20 20 cm / 8"



255-05-17 17 cm / 6 3/4"  
255-06-20 20 cm / 8"



1/2  
Kader-Mathieu  
255-07-15 15 cm / 6"  
255-08-18 18 cm / 7"  
255-09-20 20 cm / 8"  
255-10-23 23 cm / 9"  
255-11-25 25 cm / 10"



1/2  
255-12-20 & 255-13-25

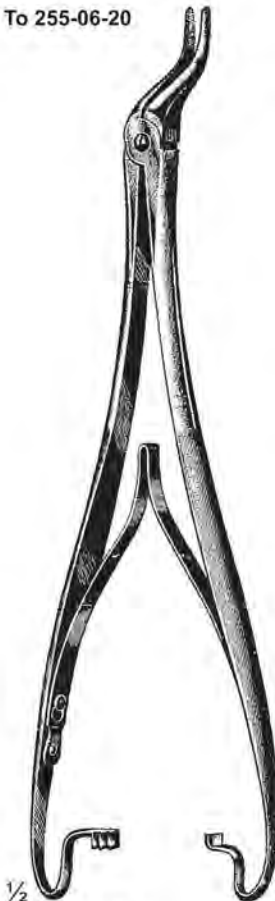
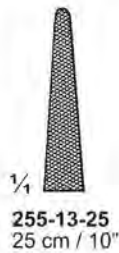

1/2  
Steinbach  
255-14-24 24 cm / 9 1/2"  
255-15-27 27 cm / 10 1/2"



1/2  
Eiselsberg-Mathieu  
255-16-18 18.5 cm / 7 1/4"  
255-17-23 23 cm / 9"  
255-18-25 25 cm / 10"





**Nadelhalter ; Porta-Agujas  
Needle Holders ; Port' Aghi  
Porte-aiguilles ; Porta agulhas**

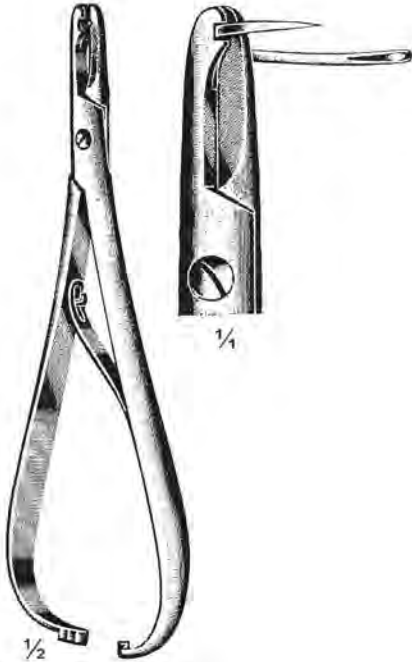

$\frac{1}{2}$   
Ermold  
256-01-17 17 cm / 6 $\frac{3}{4}$ "  
256-02-20 20 cm / 8"



$\frac{1}{2}$   
256-03-20 To 256-07-25



$\frac{1}{4}$   
256-03-20  
20 cm / 8"



$\frac{1}{4}$   
256-04-20  
20 cm / 8"



$\frac{1}{4}$   
256-05-20  
20 cm / 8"



$\frac{1}{4}$   
256-06-20  
20 cm / 8"

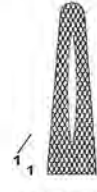

$\frac{1}{4}$   
256-07-25  
25 cm / 10"

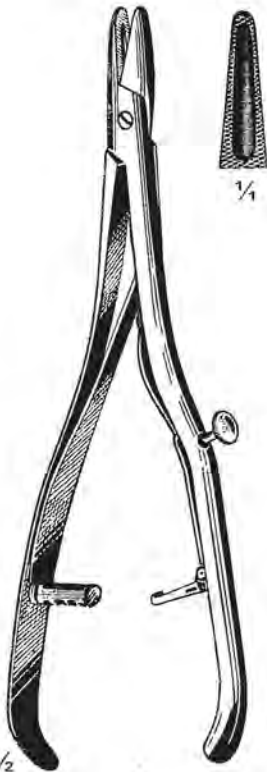

$\frac{1}{2}$   
Mayo  
256-08-16 16 cm / 6 $\frac{1}{4}$ "  
256-09-18 18 cm / 7"  
256-10-20 20 cm / 8"



$\frac{1}{4}$



$\frac{1}{2}$   
Luethy-Beck  
256-11-20 & 256-12-20  
20 cm / 8"



$\frac{1}{4}$   
256-11-20



$\frac{1}{4}$   
256-12-20



Hoesel  
256-13-25 & 256-14-25  
25 cm / 10"



$\frac{1}{4}$   
256-13-25



$\frac{1}{4}$   
256-14-25

Nadelhalter ; Porta-Agujas  
 Needle Holders ; Port Aghi  
 Porte-aiguilles ; Porta agulhas

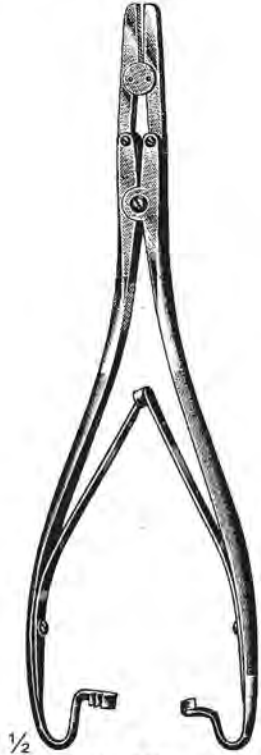
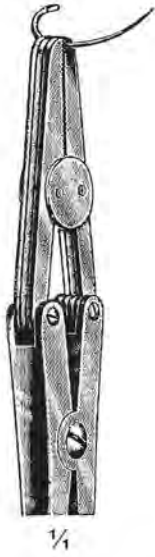

Wagner  
 257-01-20  
 20 cm / 8"

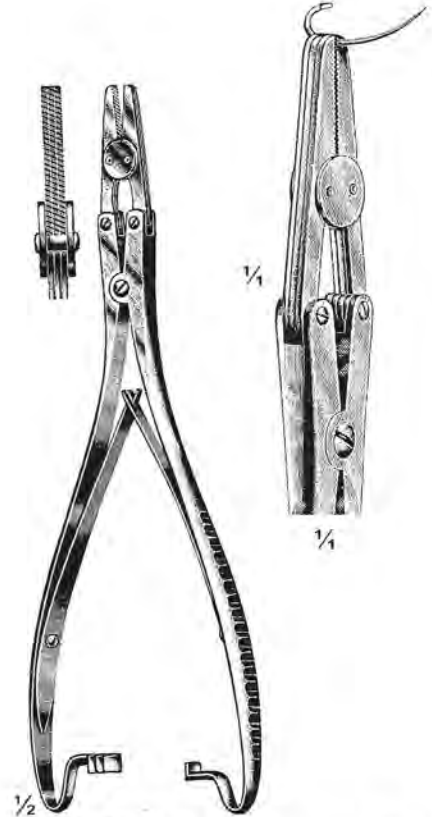

Wagner  
 257-02-20  
 20 cm / 8"

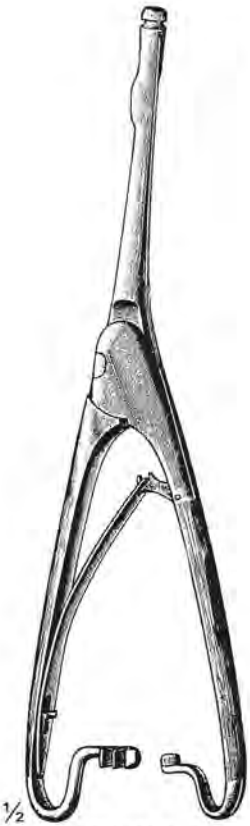

Hagedorn  
 257-03-20  
 20 cm / 8"

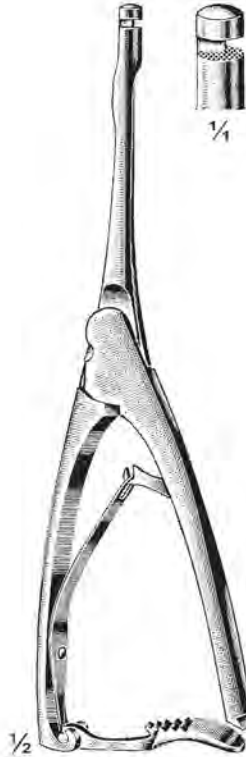

Hagedorn  
 257-04-20  
 20 cm / 8"



1/4

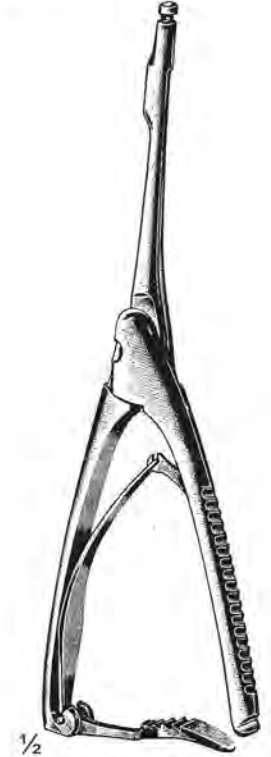

Hagedorn  
 257-05-20  
 20 cm / 8"

Nadelhalter mit Hartmetalleinlagen ; Porta-Agujas con insertos de carburo de tungsteno  
 Needle Holder with Tungsten Carbide Inserts ; Port`Aghi con inserti in carburo di tungsteno  
 Porte-aiguilles avec plaquettes en carbure tungstène ; Porta-agulhas e carboneto de tungstênio

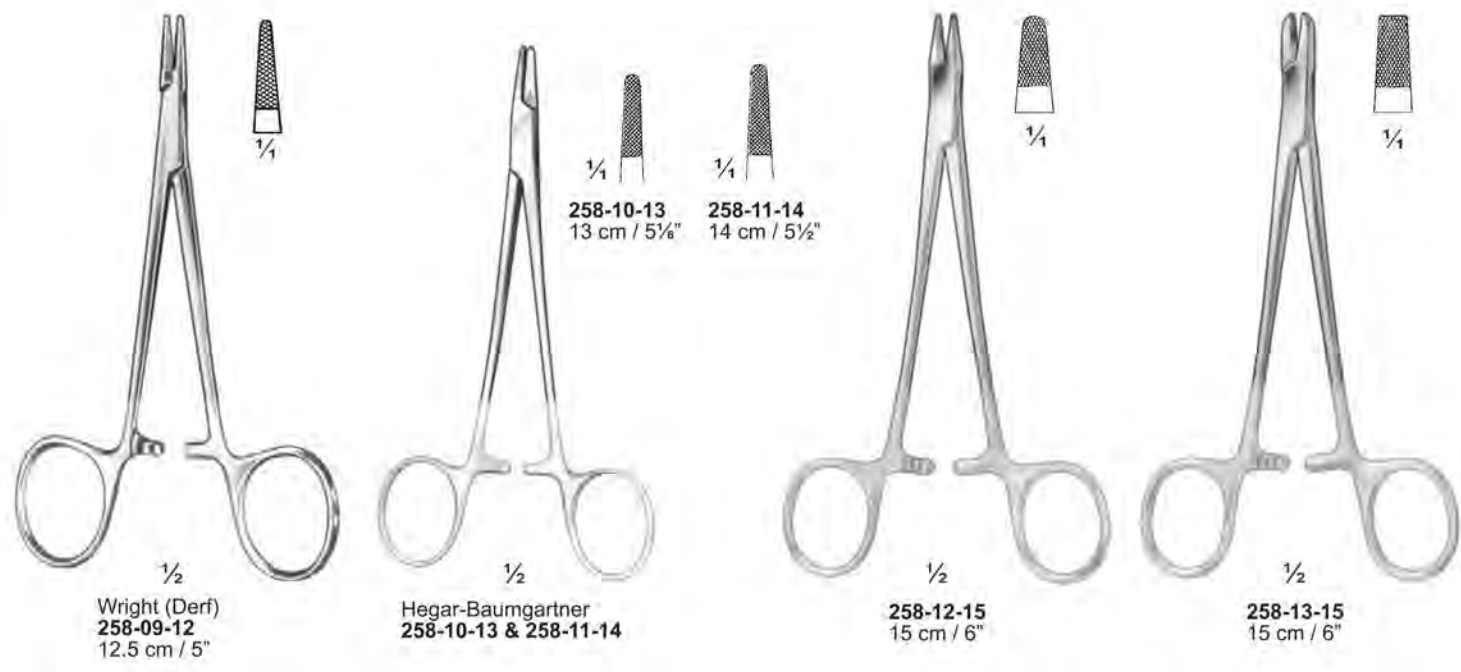
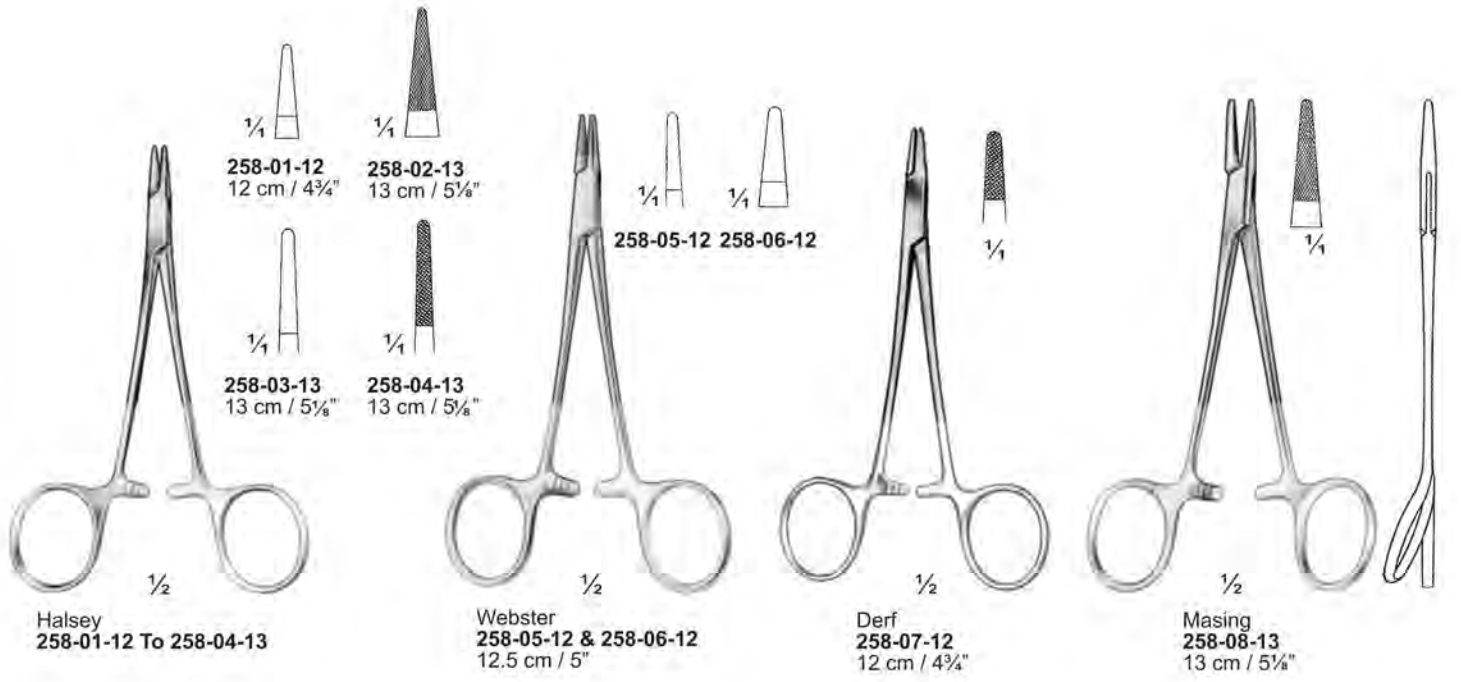

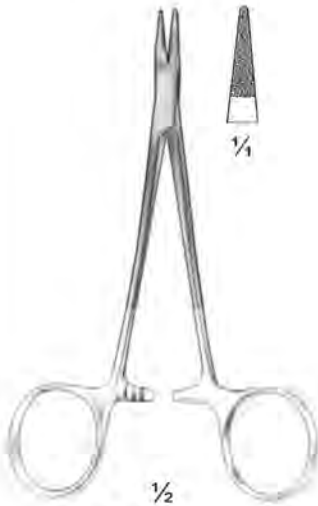

Converse  
259-01-13  
13 cm / 5 1/8"



Baby-Crile-Wood  
259-02-15  
15 cm / 6"



Crile-Wood  
259-03-14 To 259-05-15

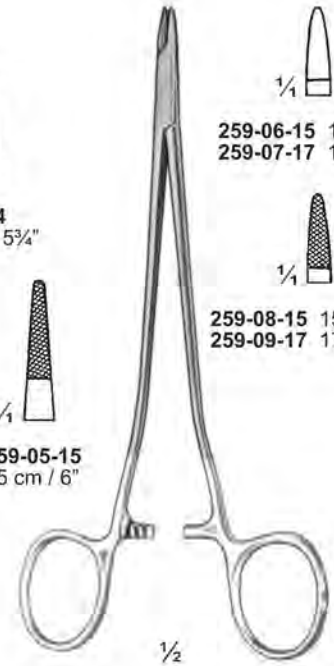
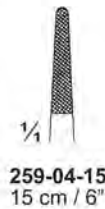
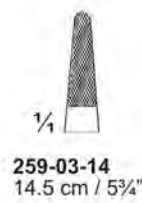

Senning  
259-06-15 To 259-09-17

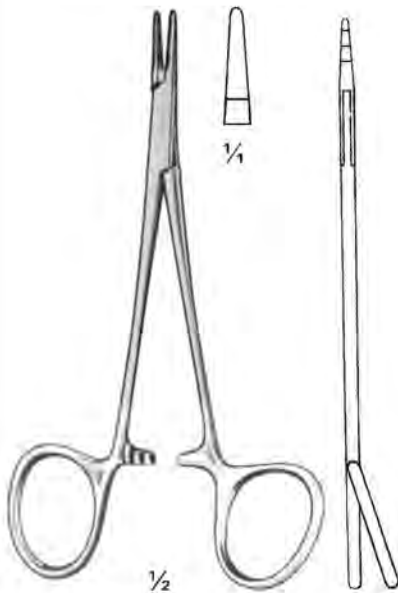
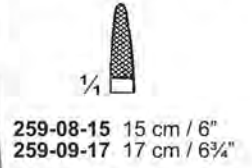
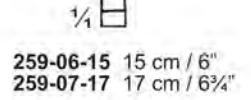

Nivert  
259-10-12  
12.5cm / 5"

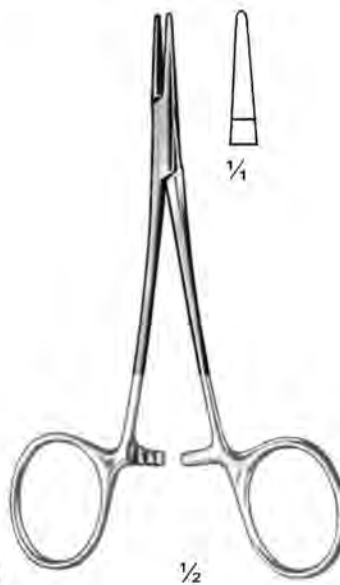

259-11-11  
11.5 cm / 4 1/2"



New Orleans  
259-12-18  
18 cm / 7"

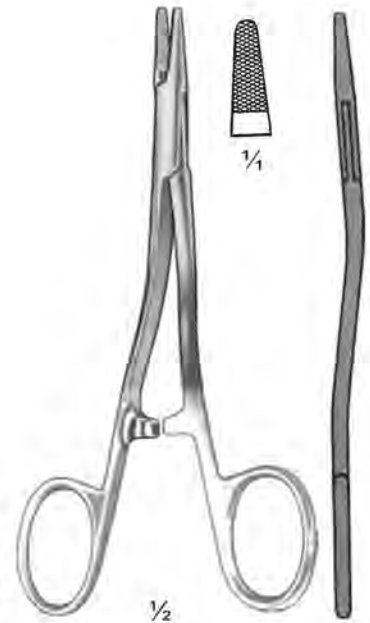

Kilner  
259-13-13  
13 cm / 5 1/8"

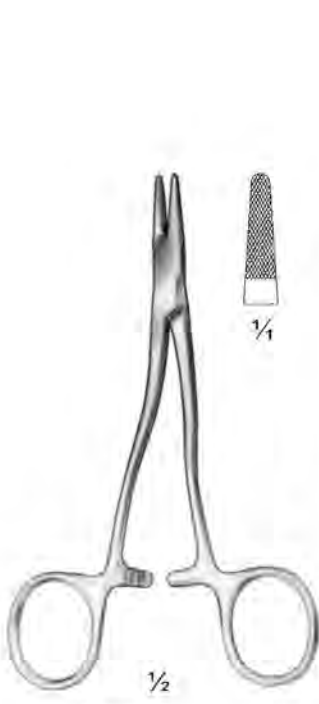

Kilner  
 260-01-13  
 13.5 cm / 5 1/4"

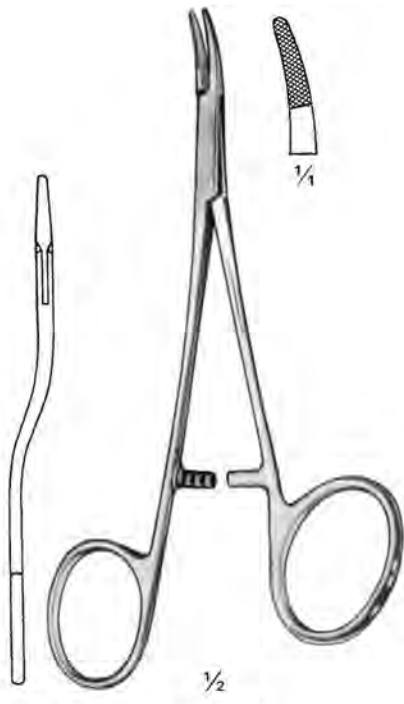

Converse  
 260-02-15  
 15 cm / 6"

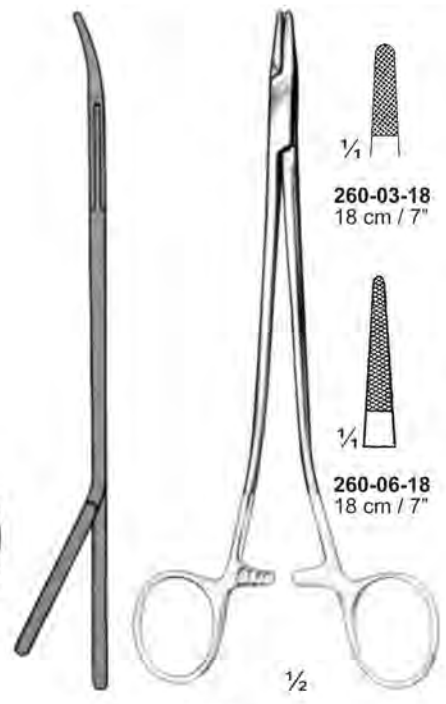

Sarot  
 260-03-18 To 260-08-27

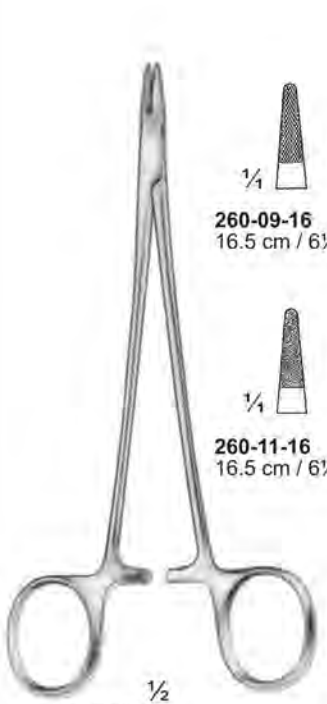
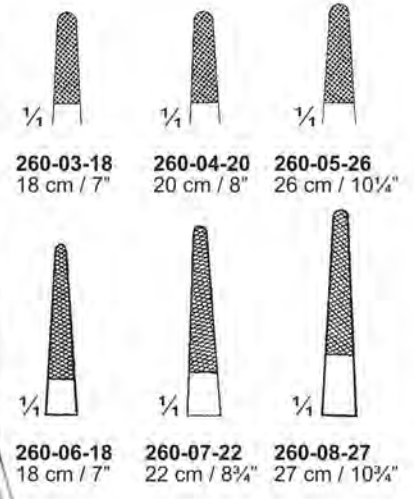

De Bakey  
 260-09-16 To 260-12-21

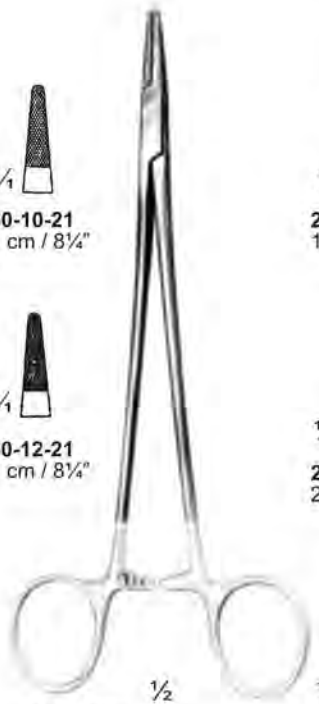

De Bakey  
 260-13-18 To 260-21-37

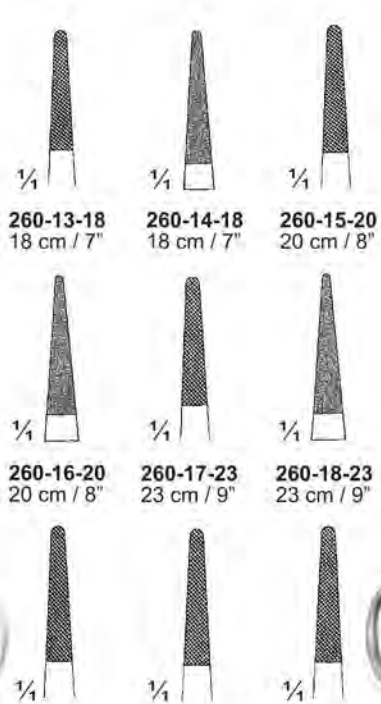

260-19-26 26 cm / 10 1/4" 1/4  
 260-20-31 31 cm / 12 1/4" 1/4  
 260-21-37 37 cm / 14 1/2" 1/4

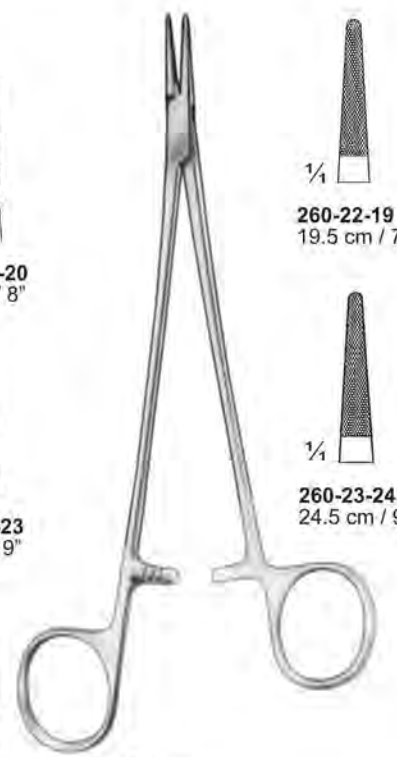

De Bakey  
 260-22-19 & 260-23-24



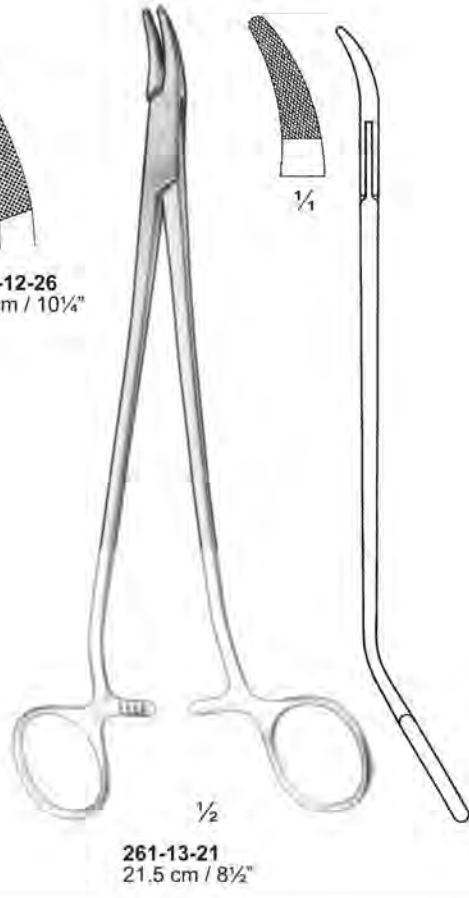
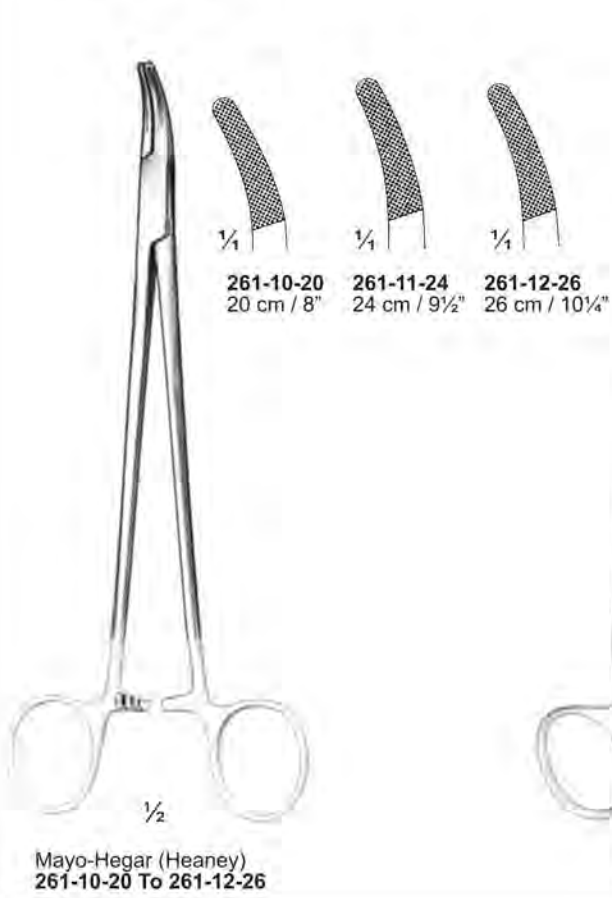
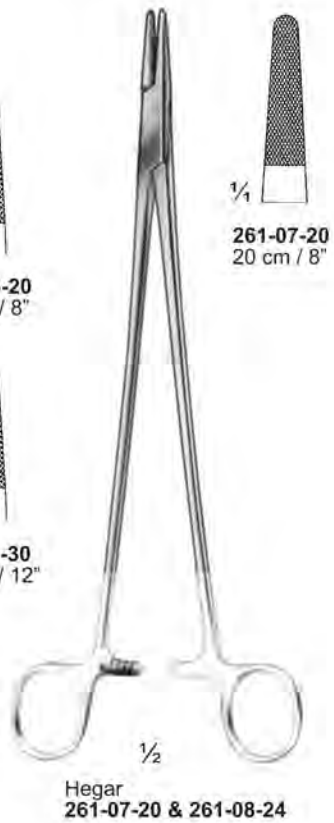
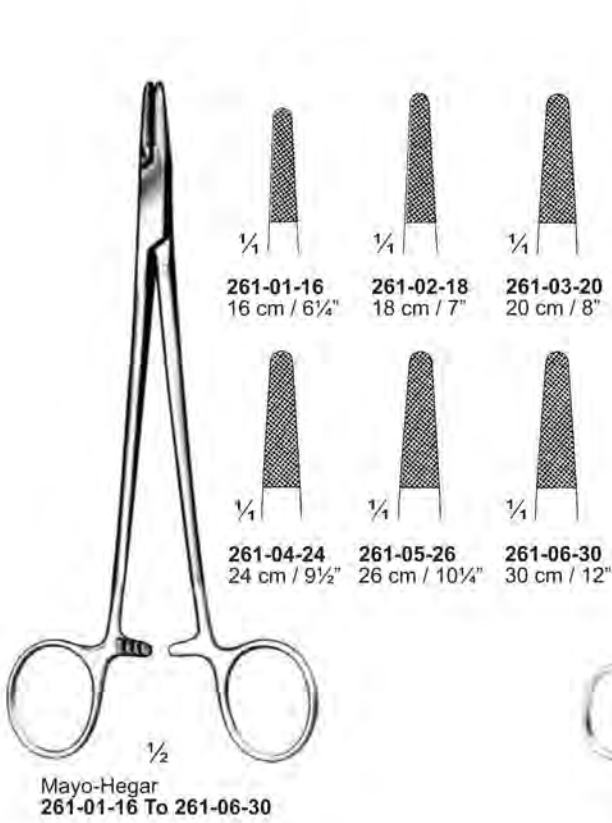

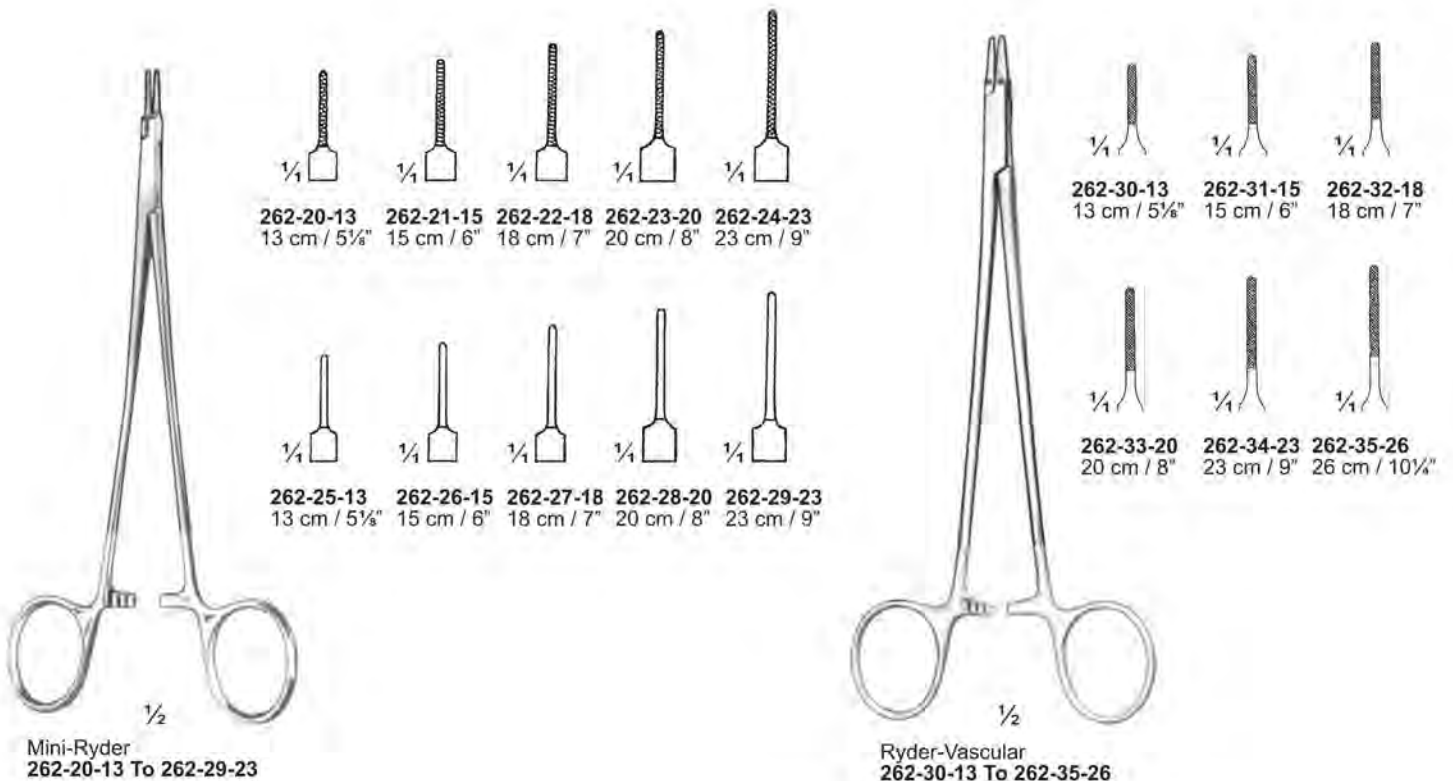
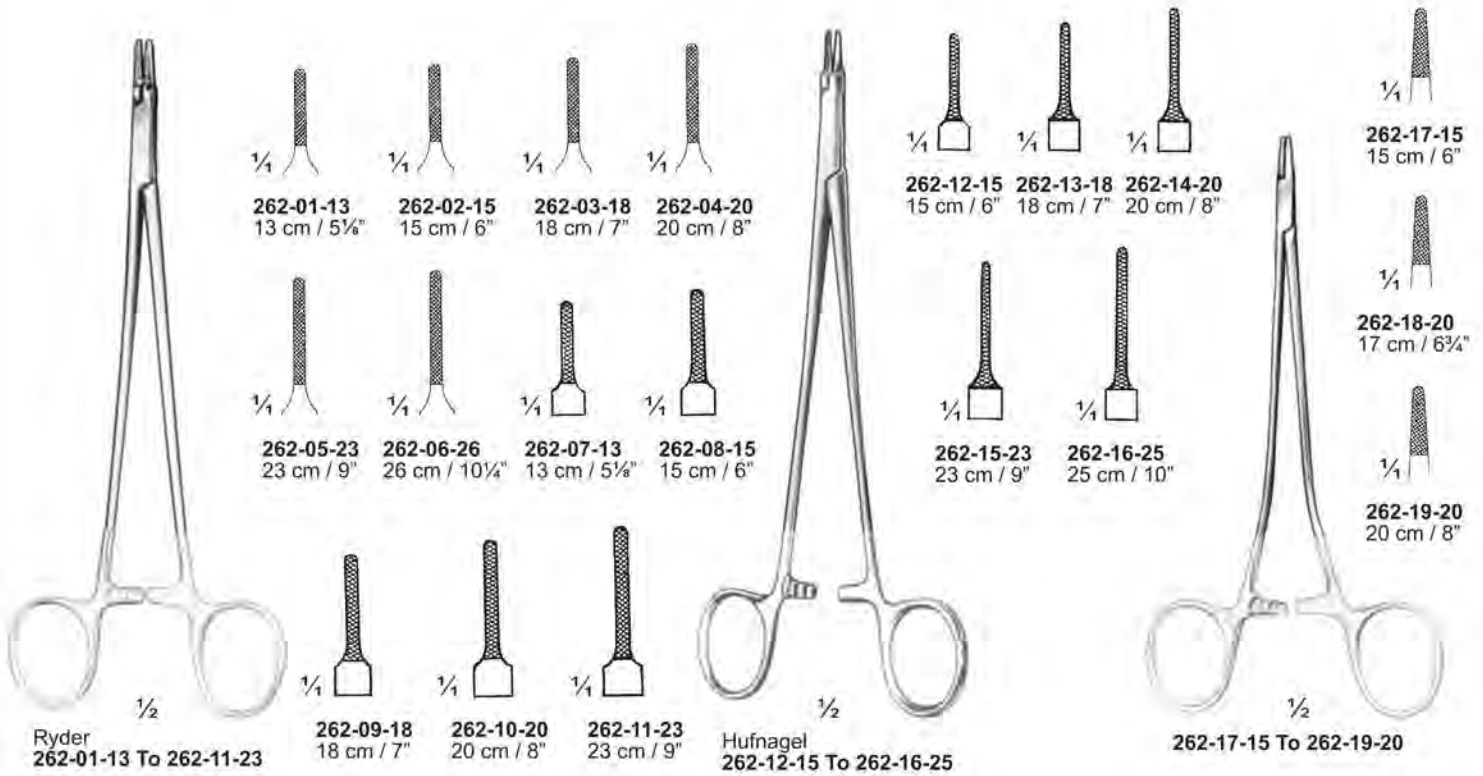



Nadelhalter mit Hartmetalleinlagen ; Porta-Agujas con insertos de carburo de tungsteno  
 Needle Holder with Tungsten Carbide Inserts ; Port' Aghi con inserti in carburo di tungsteno  
 Porte-aiguilles avec plaquettes en carbure tungstène ; Porta agulhas e carboneto de tungstênio

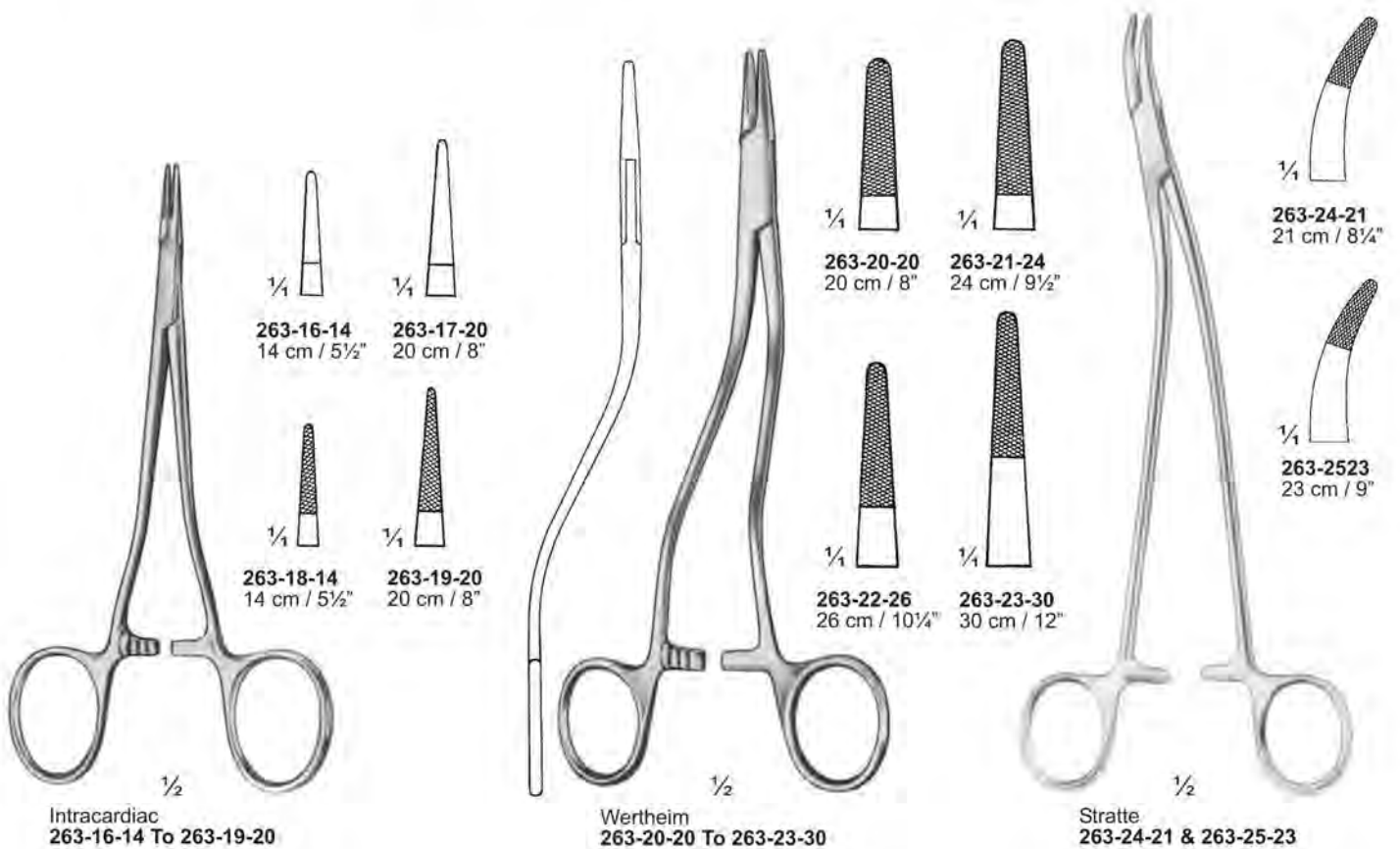
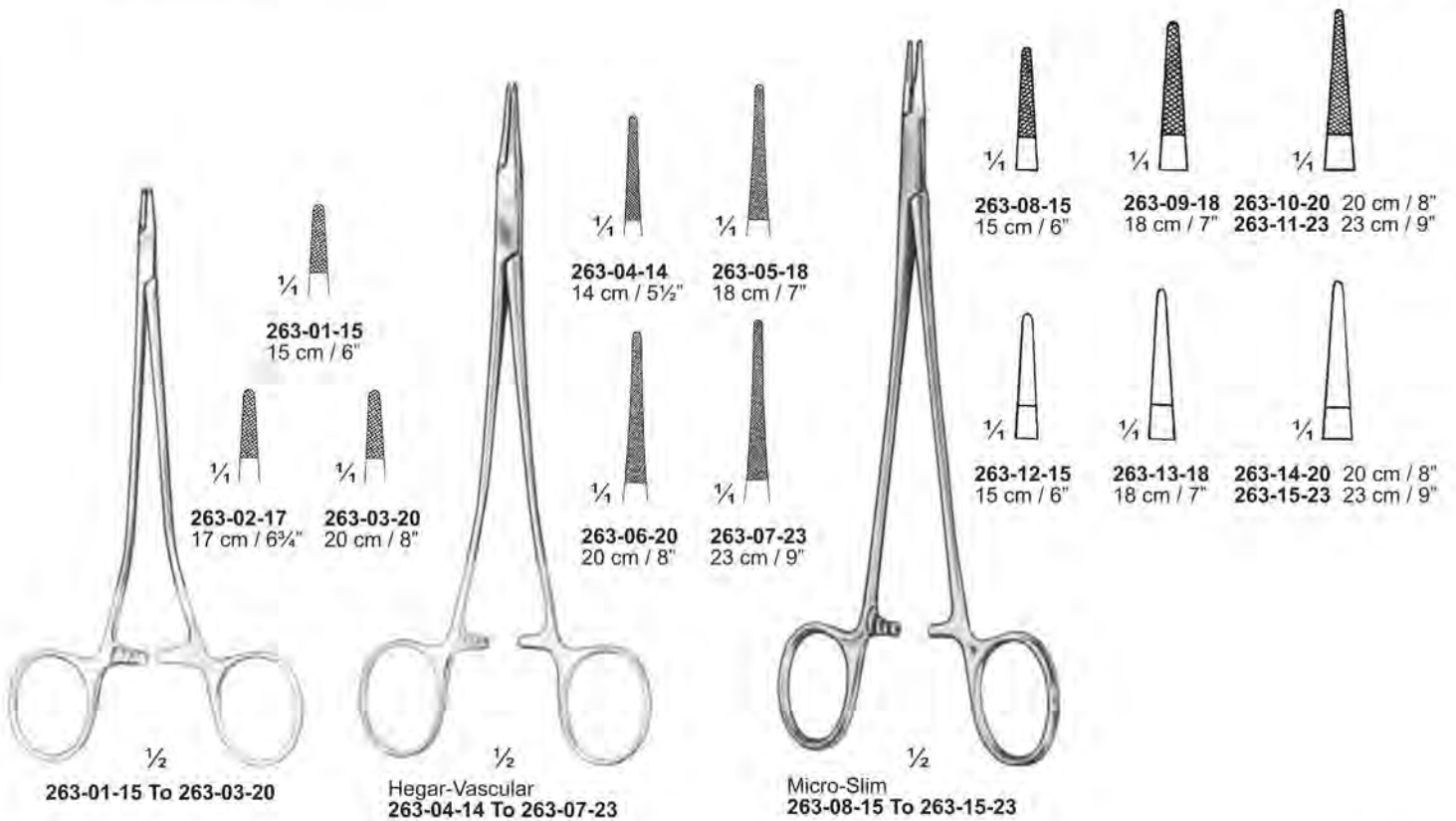



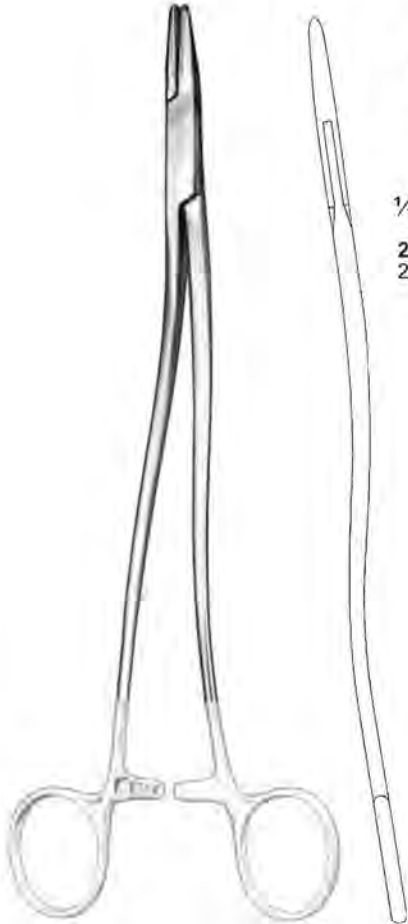

Bozemann  
264-01-20 To 264-03-26

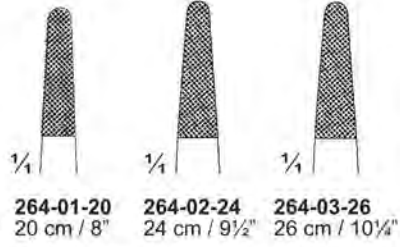

Wangensteen  
264-04-27  
27.5 cm / 10¾"

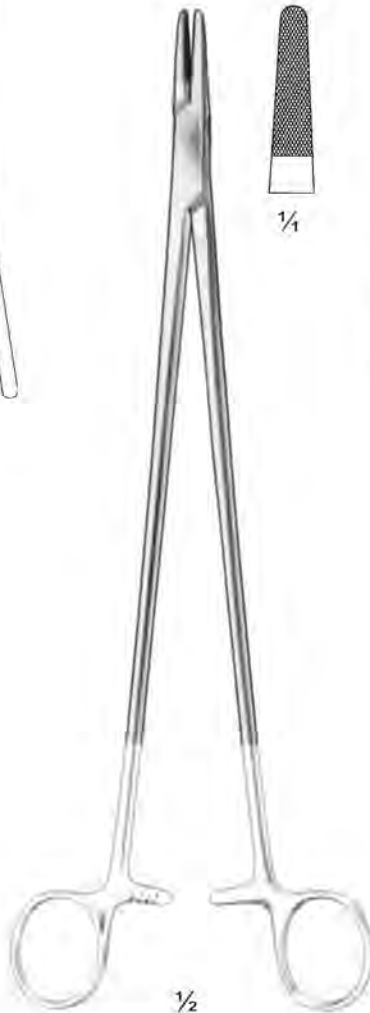

Masson  
264-05-26  
26.5 cm / 10½"



Finochietto  
264-06-26  
26.5 cm / 10½"





1/2  
 Naunton Morgan  
 265-01-26  
 26 cm / 10 1/4"



1/2  
 265-02-27  
 27.5 cm / 10 3/4"

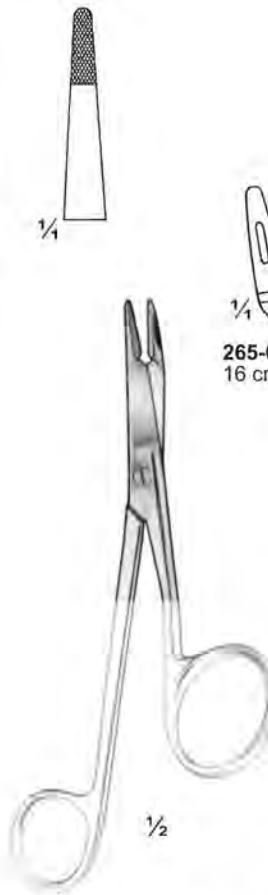

Gillies  
 265-03-16 To 265-05-16

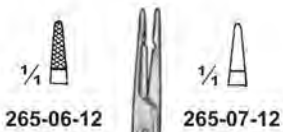
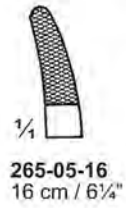

265-06-12      265-07-12



1/2  
 Olsen-Hegar  
 265-06-12 & 265-07-12  
 12 cm / 4 3/4"

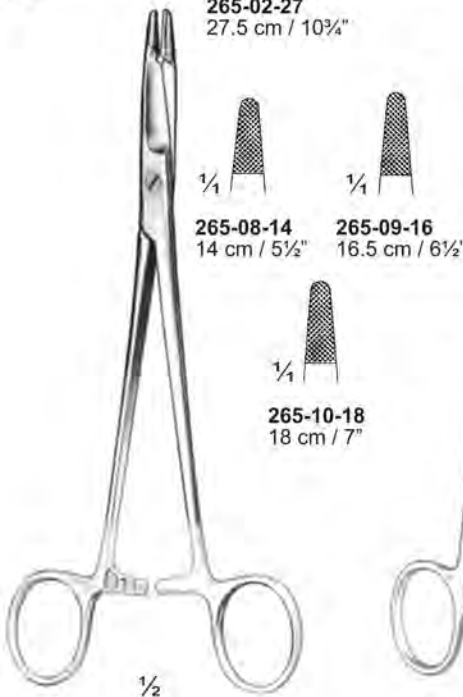

1/2  
 Olsen-Hegar  
 265-08-14 To 265-10-18

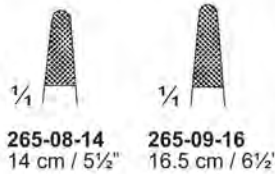

265-08-14      265-09-16  
 14 cm / 5 1/2"      16.5 cm / 6 1/2"

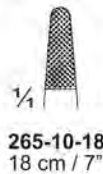

265-10-18  
 18 cm / 7"

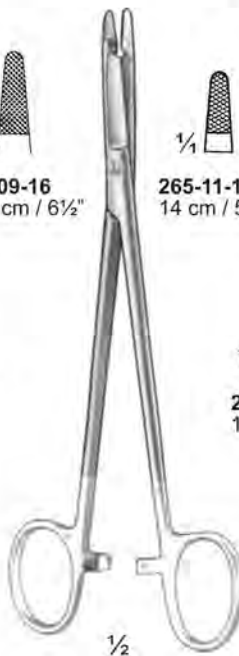

1/2  
 Olsen-Hegar  
 265-11-14 To 265-13-19

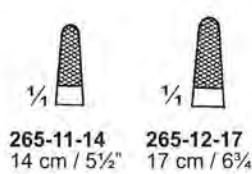

265-11-14      265-12-17  
 14 cm / 5 1/2"      17 cm / 6 3/4"

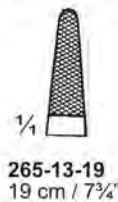

265-13-19  
 19 cm / 7 3/4"

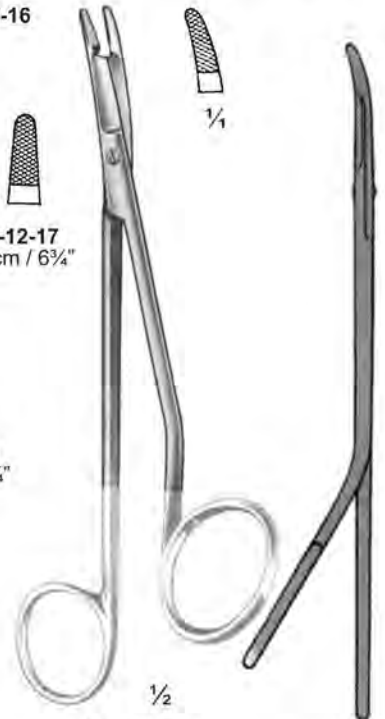

1/2  
 Gillies-Slim  
 265-14-14  
 14.5 cm / 5 3/4"

**Nadelhalter mit Hartmetalleinlagen**  
**Needle Holder with Tungsten Carbide Inserts**  
**Porte-aiguilles avec inserts en carbure tungstène**

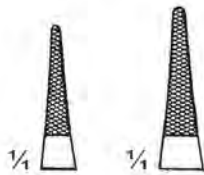

**266-01-14** 14 cm / 5½"  
**266-02-17** 17 cm / 6¾"



**266-03-20**  
 20 cm / 8"

Mathieu-Kocher  
 266-01-14 To 266-03-20

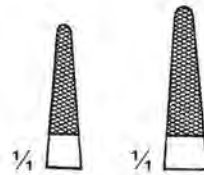

**266-04-14** 14 cm / 5½"  
**266-05-17** 17 cm / 6¾"



**266-06-20**  
 20 cm / 8"



**266-07-24**  
 24 cm / 9½"

Mathieu  
 266-04-14 To 266-07-24

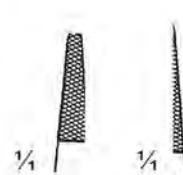
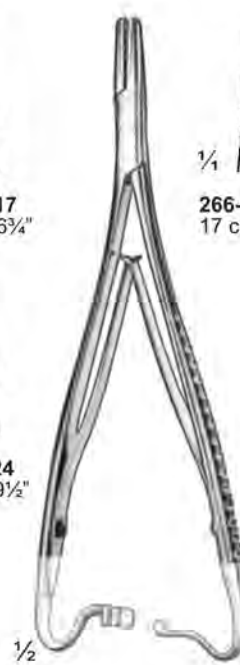

**266-08-17** 17 cm / 6¾"  
**266-09-20** 20 cm / 8"



**266-10-23**  
 23 cm / 9"

Mathieu  
 266-08-17 To 266-10-23



Lichtenberg  
 266-11-20  
 20 cm / 8"

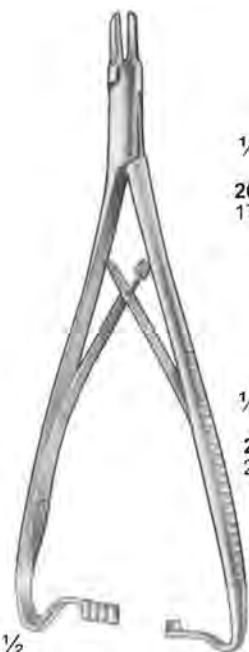

**266-12-17**  
 17 cm / 6¾"

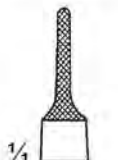

**266-13-20**  
 20 cm / 8"

Mathieu-Slim  
 266-12-17 & 266-13-20



**266-14-17**  
 17 cm / 6¾"



**266-15-20**  
 20 cm / 8"

Metzenbaum-Mathieu  
 266-14-17 & 266-15-20



**266-16-14** 14 cm / 5½"  
**266-17-17** 17 cm / 6¾"



**266-18-20**  
 20 cm / 8"

Mathieu  
 266-16 To 266-18

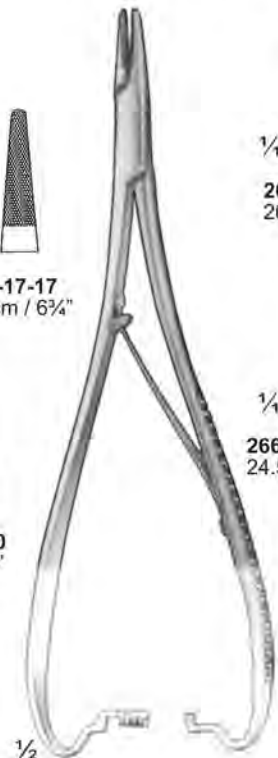

**266-19-20**  
 20 cm / 8"



**266-20-24**  
 24.5 cm / 9½"

Mathieu  
 266-19-20 & 266-20-24

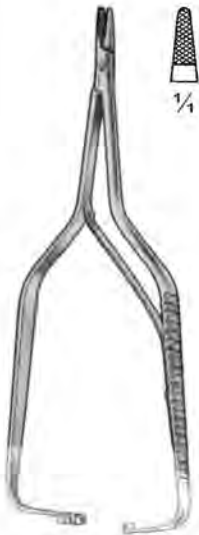

Boynton  
267-01-12  
12 cm / 4¾"



Arruga  
267-02-16  
16 cm / 6¼"



Lichtenberg  
267-03-20 & 267-04-25



267-03-20  
20 cm / 8"



267-04-25  
25 cm / 10"



267-05-20 & 267-06-25



267-05-20  
20 cm / 8"



267-06-25  
25 cm / 10"



Zweifel  
267-07-20 & 267-08-23



267-07-20  
20 cm / 8"



267-08-23  
23 cm / 9"

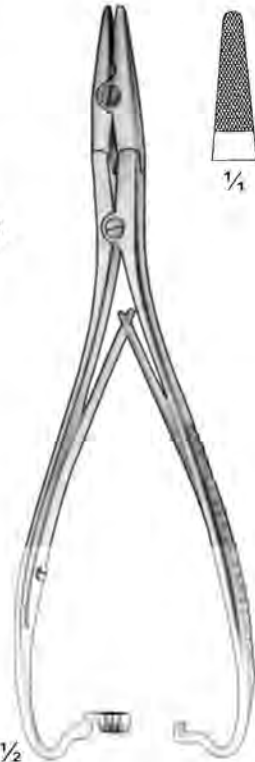

267-09-20  
20 cm / 8"



¼



Hoesel  
267-10-25 & 467-11-26



267-10-25  
25 cm / 10"



267-11-26  
26 cm / 10¼"



Luethy-Beck  
267-12-20  
20 cm / 8"



¼



Toennis  
268-01-18  
18 cm / 7"



Langenbeck-Ryder  
268-02-20  
20 cm / 8"



Langenbeck  
268-03-16 To 268-05-20

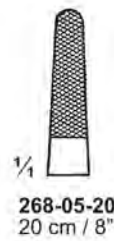
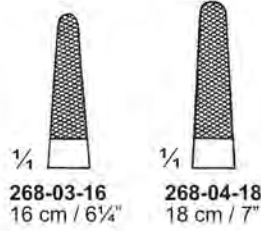

Langenbeck  
268-06-18 To 268-08-23

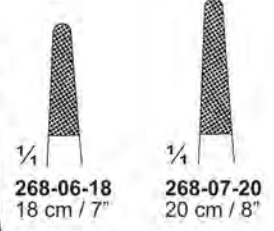

Kalt  
268-09-14  
14 cm / 5 1/2"



Castroviejo  
268-10-13  
13 cm / 5 1/8"



Castroviejo  
268-11-14 To 268-16-21

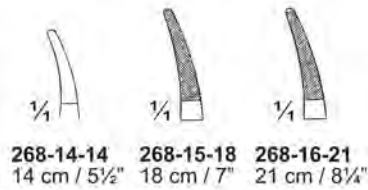
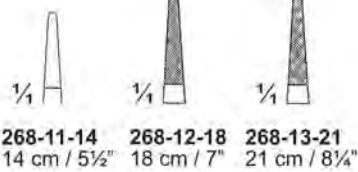

Jacobson  
268-17-18 18.5 cm / 7 1/4"  
268-18-21 21 cm / 8 1/4"



**Mikro-Nadelhalter ; Micro Porta-Agujas  
 Micro Needle Holder ; Micro Port`Aghi  
 Micro Porte-aiguilles ; Micro Porta agulhas**



**Barraquer**  
**269-01-16**  
 16 cm / 6 1/4"



**Barraquer**  
**269-02-14**  
 14 cm / 5 1/2"



**Berens**  
**269-03-14**  
 14 cm / 5 1/2"



**Stevens**  
**269-04-13** 13 cm / 5 1/4"  
**269-05-15** 15 cm / 6"



**Potts-Smith**  
**269-06-22**  
 22 cm / 8 3/4"



**Castroviejo-Kalt**  
**269-07-13**  
 13.5 cm / 5 1/4"



**Kalt-Arruga**  
**269-08-14**  
 14 cm / 5 1/2"



**Kalt**  
**269-09-14**  
 14 cm / 5 1/2"





**Arruga**  
**269-10-14**  
 14 cm / 5 1/2"



**Arruga**  
**269-11-14**  
 14 cm / 5 1/2"

**Mikro-Nadelhalter ; Micro Porta-Agujas  
 Micro Needle Holder ; Micro Port`Aghi  
 Micro Porte-aiguilles ; Micro Porta agulhas**



$\frac{1}{4}$    
**270-01-14**  
 $\frac{1}{4}$    
**270-02-14**

**Barraquer  
 270-01-14 & 270-02-14  
 14 cm / 5½"**



$\frac{1}{2}$    
**Barraquer  
 270-03-11  
 11 cm / 4¼"**



$\frac{1}{2}$    
**Barraquer  
 270-04-13  
 13 cm / 5¼"**



$\frac{1}{2}$    
**Barraquer  
 270-05-14  
 14 cm / 5½"**



$\frac{1}{2}$    
**Barraquer  
 270-06-13  
 13 cm / 5¼"**



$\frac{2}{3}$    
**Noyes  
 270-07-14  
 14 cm / 5½"**



$\frac{1}{4}$    
**Barraquer-Troutman  
 270-08-10  
 10 cm / 4"**



$\frac{1}{4}$    
**Barraquer-Troutman  
 270-09-10  
 10 cm / 4"**



$\frac{1}{4}$    
**Barraquer-Troutman  
 270-10-10  
 10 cm / 4"**



$\frac{1}{4}$    
**Barraquer-Troutman  
 270-11-10  
 10 cm / 4"**

**Mikro-Nadelhalter ; Micro Porta-Agujas  
Micro Needle Holder ; Micro Port`Aghi  
Micro Porte-aiguilles ; Micro Porta agulhas**



Rohrschneider  
271-01-10  
10 cm / 4"



Castroviejo  
271-02-09  
9 cm / 3 1/2"



Castroviejo  
271-03-09  
9 cm / 3 1/2"



Castroviejo  
271-04-09  
9 cm / 3 1/2"



Castroviejo  
271-05-09  
9 cm / 3 1/2"



271-06-14



271-08-14



271-10-14

271-11-14

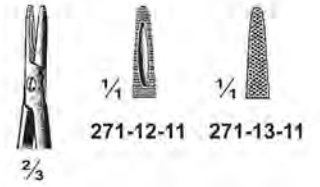

271-12-11 271-13-11

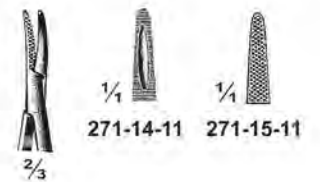

271-14-11 271-15-11

Castroviejo  
271-06-14 & 271-07-14  
14 cm / 5 1/2"

Castroviejo  
271-08-14 & 271-09-14  
14 cm / 5 1/2"

Castroviejo  
271-10-14 & 271-11-14  
14 cm / 5 1/2"

Paton  
271-12-11 To 271-15-11  
11 cm / 4 1/4"





**Mikro-Nadelhalter ; Micro Porta-Agujas  
Micro Needle Holder ; Micro Port`Aghi  
Micro Porte-aiguilles ; Micro Porta agulhas**



272-01-15



272-02-15

1/2

Reill  
272-01-15 & 272-02-15  
15 cm / 6"



272-03-15



272-04-15

1/2

272-03-15 & 272-04-15  
15 cm / 6"



272-05-18



272-06-18

1/2

272-05-18 & 272-06-18  
18 cm / 7"



272-07-18



272-08-18

1/2

272-07-18 & 272-08-18  
18 cm / 7"



1/2

Müller  
272-09-14  
14.5 cm / 5 3/4"



1/2

272-10-23  
23 cm / 9"



272-11-15



272-12-15

1/2

Brock  
272-11-15 & 272-12-15  
15 cm / 6"



272-13-18



272-14-18

1/2

Brock  
272-13-18 & 272-14-18  
18 cm / 7"



272-15-16



272-16-16

1/4

Arruga  
272-15-16 & 272-16-16  
16 cm / 6 1/4"



1/4

1/4

2/3

Castroviejo  
272-17-14  
14 cm / 5 1/2"



**Mikro-Nadelhalter ; Micro Porta-Agujas  
 Micro Needle Holder ; Micro Port`Aghi  
 Micro Porte-aiguilles ; Micro Porta agulhas**

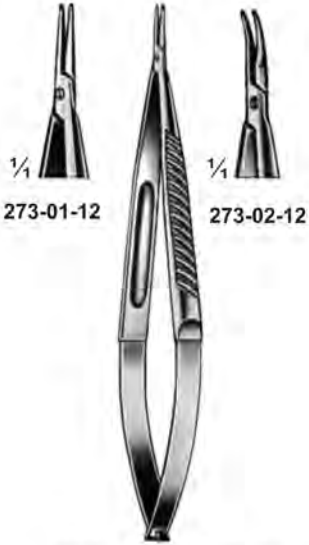

273-01-12

273-02-12

273-01-12 & 273-02-12  
12 cm / 4 3/4"

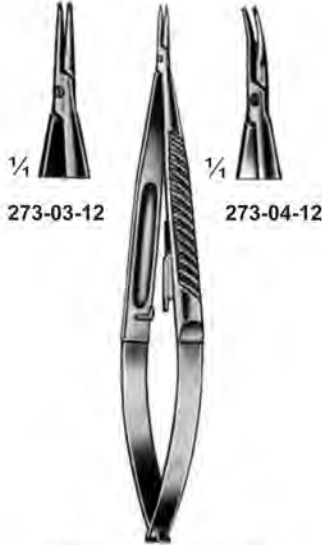

273-03-12

273-04-12

273-03-12 & 273-04-12  
12 cm / 4 3/4"



1/4

1/4

273-05-12  
12 cm / 4 3/4"



1/4

1/4

273-06-12  
12 cm / 4 3/4"

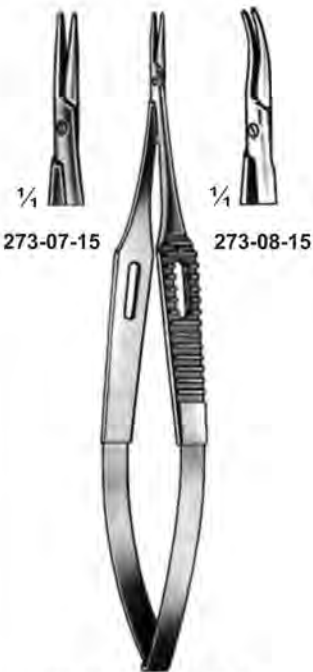

1/4

1/4

273-07-15

273-08-15

273-07-15 & 273-08-15  
15 cm / 6"

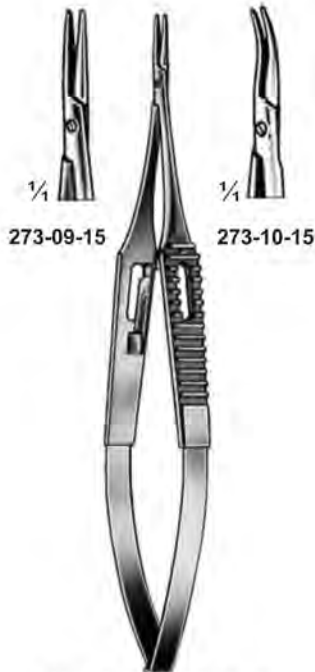

1/4

1/4

273-09-15

273-10-15

273-09-15 & 273-10-15  
15 cm / 6"

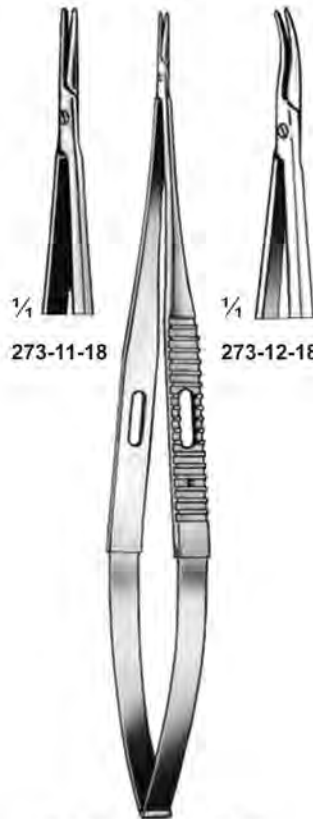

1/4

1/4

273-11-18

273-12-18

273-11-18 & 273-12-18  
18 cm / 7"

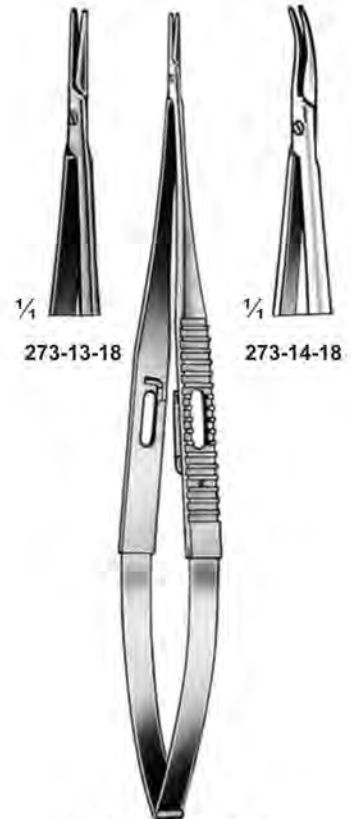

1/4

1/4

273-13-18

273-14-18

273-13-18 & 273-14-18  
18 cm / 7"



**Mikro-Nadelhalter ; Micro Porta-Agujas  
 Micro Needle Holder ; Micro Port`Aghi  
 Micro Porte-aiguilles ; Micro Porta agulhas**



Gomel  
 274-01-14 To 274-03-14  
 14 cm / 5½"



¼  
 274-01-14



¼  
 274-02-14



¼  
 274-03-14



Gomel  
 274-04-16 To 274-06-16  
 16 cm / 6¼"



¼

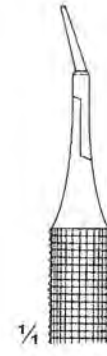

¼  
 274-04-16



¼  
 274-05-16

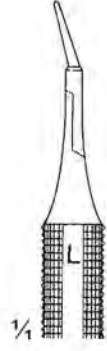

¼  
 274-06-16



Jacobson  
 274-07-18 & 274-08-18  
 18.5 cm / 7¼"



¼  
 274-07-18  
 With catch



¼  
 274-08-18  
 Without catch



Castroviejo  
 274-09-13  
 13 cm / 5¼"



Castroviejo-Barraquer  
 274-10-12  
 12 cm / 4¾"



Castroviejo  
 274-11-12  
 12 cm / 4¾"

**Mikro-Nadelhalter ; Micro Porta-Agujas  
 Micro Needle Holder ; Micro Port`Aghi  
 Micro Porte-aiguilles ; Micro Porta agulhas**



Jacobson  
 275-01-18  
 18.5 cm / 7 1/4"



275-02-16  
 16 cm / 6 1/4"



Yasargil  
 275-03-20 & 275-04-20  
 20 cm / 8"

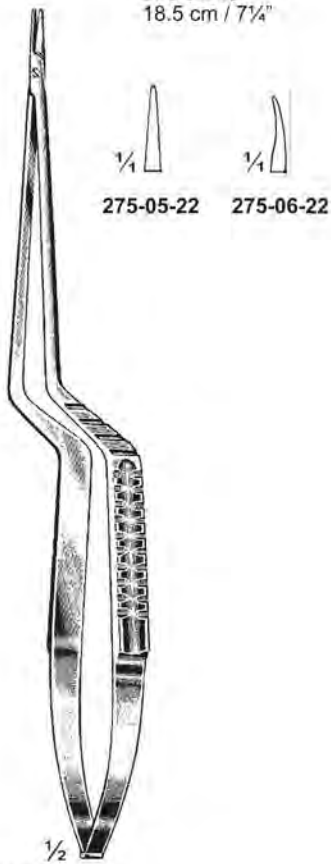

Yasargil  
 275-05-22 & 275-06-22  
 22.5 cm / 8 3/4"



Yasargil  
 275-07-22 & 275-08-22  
 22.5 cm / 8 3/4"



Yasargil  
 275-09-24  
 24.5 cm / 9 3/4"



Reverdin Nadeln, Unterbindungsnadeln ; Aguja para ligatura  
 Reverdin Needles, Ligature Needles ; Aghi per legatura  
 Aguilles de Reverdin, aiguilles à ligature ; Agulhas de Reverdin



Reverdin  
 276-01-14 To 276-04-14  
 14 cm / 5 1/2"



276-01-14    276-02-14    276-03-14    276-04-14



Reverdin  
 276-05-19 To 276-08-19  
 19.5 cm / 7 3/4"



276-05-19    276-06-19    276-07-19    276-08-19



Reverdin  
 276-09-22 To 276-12-22  
 22 cm / 8 3/4"



276-09-22    276-10-22    276-11-22    276-12-22



Reverdin Nadeln, Unterbindungsnadeln ; Aguja para ligatura  
Reverdin Needles, Ligature Needles ; Aghi per legatura  
Aguilles de Reverdin, aiguilles à ligature ; Agulhas de Reverdin



1/4

Albaran  
277-01-19 To 277-06-19  
19.5 cm / 7 3/4"

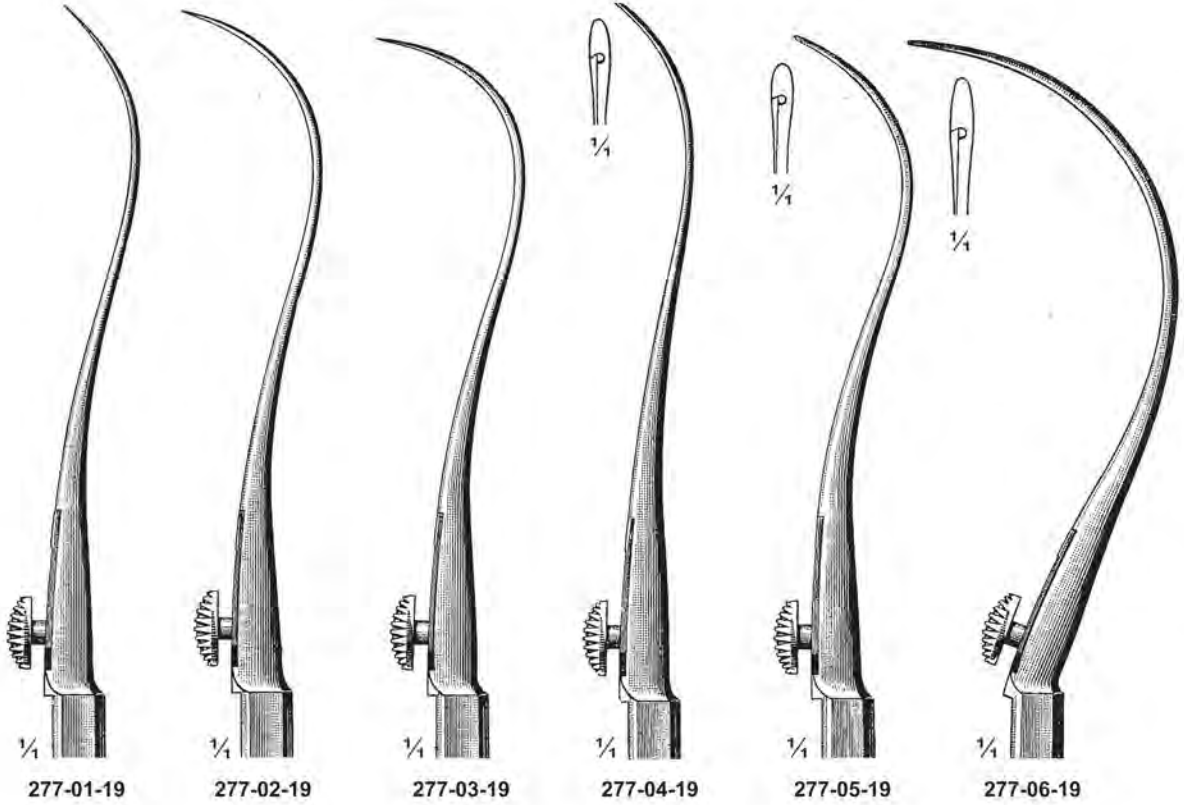

277-01-19

277-02-19

277-03-19

277-04-19

277-05-19

277-06-19



Reverdin Nadeln, Unterbindungsnadeln ; Aguja para ligatura  
Reverdin Needles, Ligature Needles ; Aghi per legatura  
Aguilles de Reverdin, aiguilles à ligature ; Agulhas de Reverdin



Reverdin  
278-01-25  
25 cm / 10"

Tierny  
278-02-25  
25 cm / 10"

Tierny  
278-03-27  
27 cm / 10½"

Redon  
278-04-25  
25 cm / 10"

Redon  
278-05-27  
27 cm / 10½"



Reverdin Nadeln, Unterbindungsnadeln ; Aguja para ligatura  
 Reverdin Needles, Ligature Needles ; Aghi per legatura  
 Aguilles de Reverdin, aiguilles à ligature ; Agulhas de Reverdin

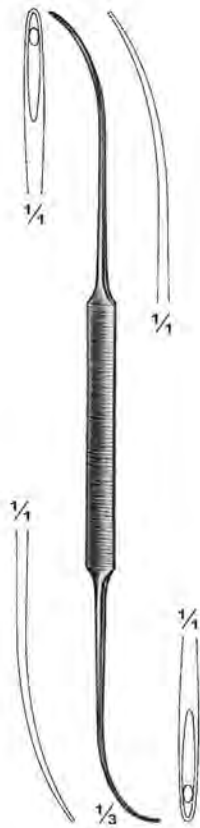

Schmieden Dick  
 279-01-32  
 32 cm / 12 1/2"



Schmieden  
 279-02-22  
 22 cm / 8 3/4"

Spare needles for  
 item No. 279-06-24 & 279-10-25

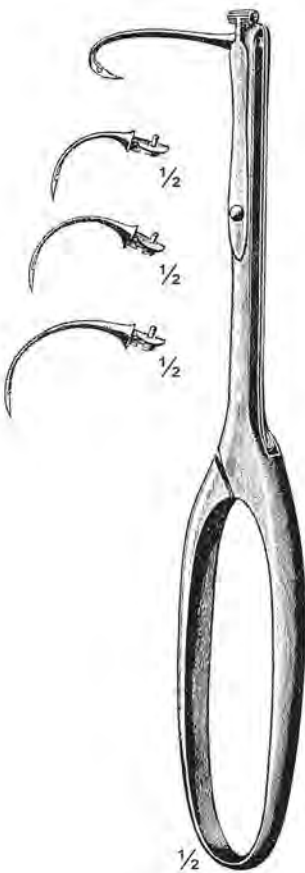

279-03-22 22 cm / 8 3/4"  
 279-04-24 24 cm / 9 1/2"  
 279-05-26 26 cm / 10 1/2"  
 Screw Joint  
 With 3 Needles



Young-Hryntschank  
 279-06-24  
 24 cm / 9 1/2"  
 For deep suturing  
 With 3 Needles



279-07-01

279-08-02

279-09-03



Young  
 279-10-25  
 25 cm / 10"  
 For deep suturing  
 With 3 Needles





**Reverdin Nadeln, Unterbindungsnadeln ; Aguja para ligatura  
 Reverdin Needles, Ligature Needles ; Aghi per legatura  
 Aguilles de Reverdin, aiguilles à ligature ; Agulhas de Reverdin**



1/2  
 Kronecker  
 280-01-15  
 15 cm / 6"



1/2  
 Kronecker  
 280-02-15  
 15 cm / 6"



1/2  
 Kronecker  
 280-03-13  
 13 cm / 5 1/8"

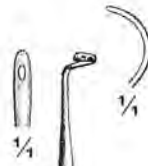

1/2  
 Kronecker  
 280-04-13  
 13 cm / 5 1/8"

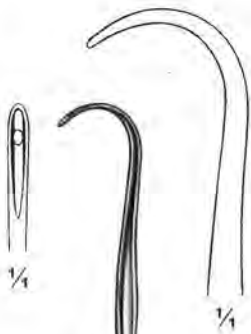

1/2  
 Cooper  
 280-05-19  
 19 cm / 7 1/2"

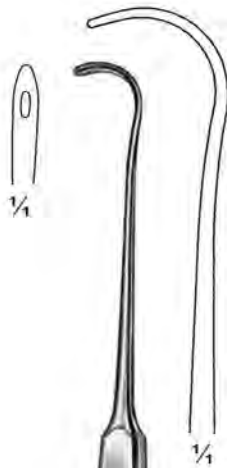

1/2  
 Cooper  
 280-06-20  
 20 cm / 8"

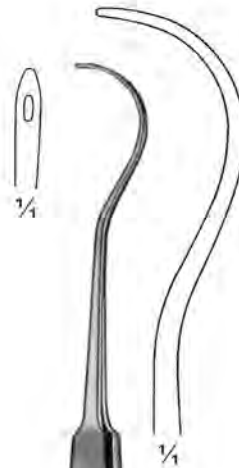

1/2  
 Kocher  
 280-07-20  
 20 cm / 8"

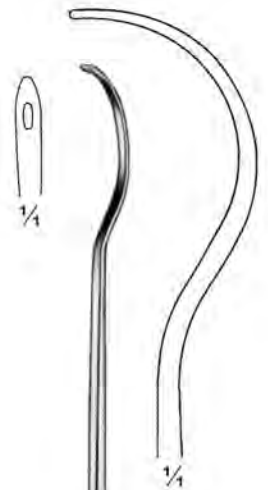

1/2  
 Brunner  
 280-08-24  
 24 cm / 9 1/2"



Reverdin Nadeln, Unterbindungsnadeln ; Aguja para ligatura  
 Reverdin Needles, Ligature Needles ; Aghi per legatura  
 Aguilles de Reverdin, aiguilles à ligature ; Agulhas de Reverdin

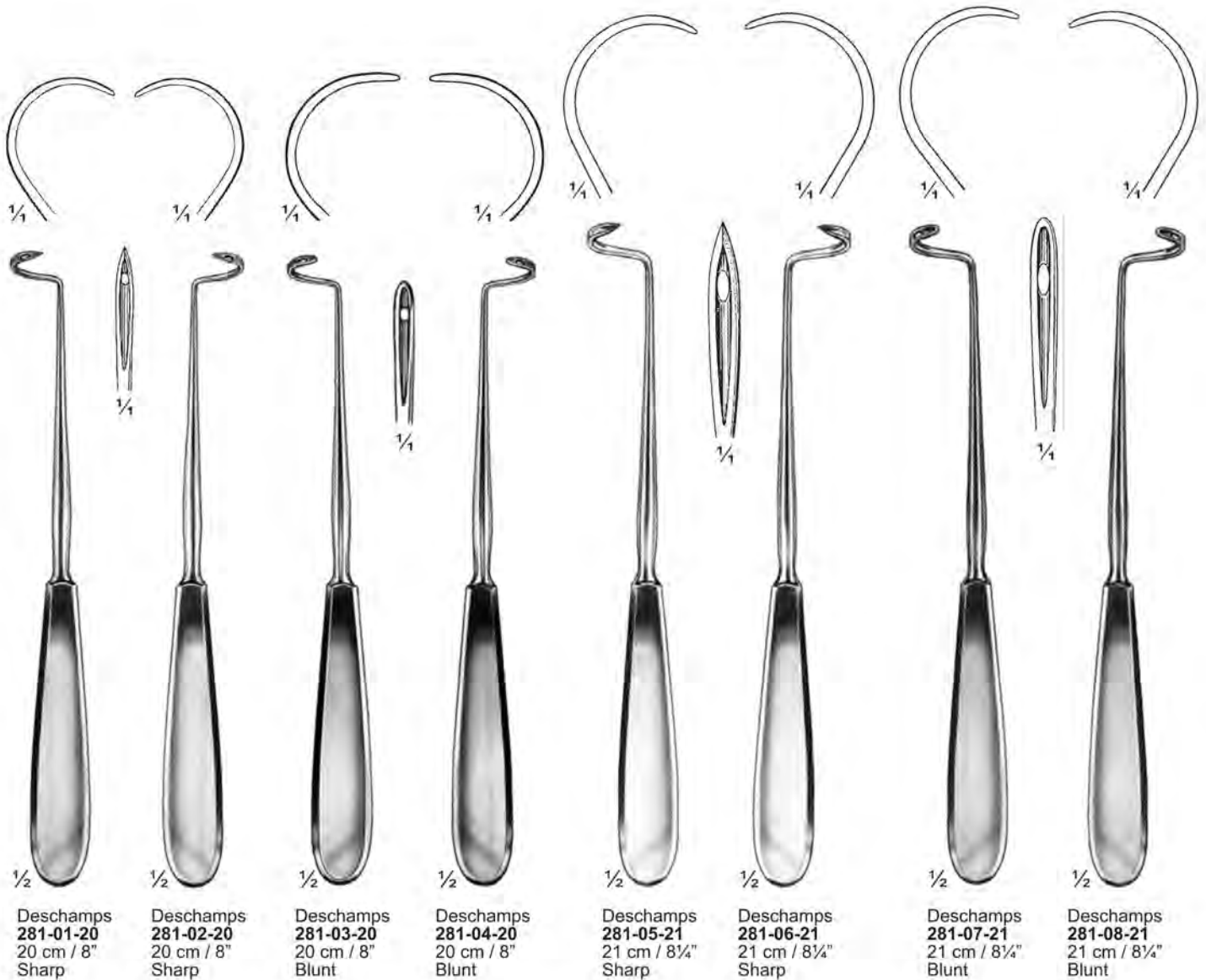



Reverdin Nadeln, Unterbindungsnadeln ; Aguja para ligatura  
 Reverdin Needles, Ligature Needles ; Aghi per legatura  
 Aiguilles de Reverdin, aiguilles à ligature ; Agulhas de Reverdin



$\frac{1}{2}$  Deschamps 282-01-24 24 cm / 9½" Blunt  
 $\frac{1}{2}$  Deschamps 282-02-24 24 cm / 9½" Blunt

$\frac{1}{2}$  Deschamps 282-03-27 27 cm / 10½" Sharp  
 $\frac{1}{2}$  Deschamps 282-04-27 27 cm / 10½" Sharp

$\frac{1}{2}$  Deschamps 282-05-27 27 cm / 10½" Blunt  
 $\frac{1}{2}$  Deschamps 282-06-27 27 cm / 10½" Blunt

$\frac{1}{2}$  Deschamps 282-07-28 28 cm / 11" Blunt  
 $\frac{1}{2}$  Deschamps 282-08-28 28 cm / 11" Blunt



Reverdin Nadeln, Unterbindungsnadeln ; Aguja para ligatura  
 Reverdin Needles, Ligature Needles ; Aghi per legatura  
 Aguilles de Reverdin, aiguilles à ligature ; Agulhas de Reverdin



283-01-20  
20 cm / 8"  
Sharp



283-02-20  
20 cm / 8"  
Sharp



283-03-20  
20 cm / 8"  
Blunt



283-04-20  
20 cm / 8"  
Blunt



283-05-20  
20 cm / 8"  
Blunt



283-06-20  
20 cm / 8"  
Blunt



Langenbeck  
283-07-19  
19 cm / 7 1/2"



Payer  
283-08-23  
23 cm / 9"



Reverdin Nadeln, Unterbindungsnadeln ; Aguja para ligatura  
Reverdin Needles, Ligature Needles ; Aghi per legatura  
Aguilles de Reverdin, aiguilles à ligature ; Agulhas de Reverdin



1/2

Dupuy-Weiss  
284-01-22  
22 cm / 8 3/4"



1/2

Dupuy-Weiss  
284-02-22  
22 cm / 8 3/4"



1/2

Yankauer  
284-03-16  
16 cm / 6 1/4"



1/2

Yankauer  
284-04-16  
16 cm / 6 1/4"



1/2

Pauchet  
284-05-27  
27 cm / 10 1/2"

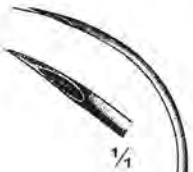

1/2

Jonesco  
284-06-18  
18.5 cm / 7 1/4"



1/2

Emmet  
284-07-19  
19.5 cm / 7 3/4"



1/2

Emmet  
284-08-19  
19.5 cm / 7 3/4"



1/2

Emmet  
284-09-19  
19.5 cm / 7 3/4"



Reverdin Nadeln, Unterbindungsnadeln ; Aguja para ligatura  
 Reverdin Needles, Ligature Needles ; Aghi per legatura  
 Aguilles de Reverdin, aiguilles à ligature ; Agulhas de Reverdin



Reverdin Nadeln, Unterbindungsnadeln ; Aguja para ligatura  
 Reverdin Needles, Ligature Needles ; Aghi per legatura  
 Aguilles de Reverdin, aiguilles à ligature ; Agulhas de Reverdin



1/2  
 286-01-13  
 13 cm / 5 1/8"



1/2  
 286-02-13  
 13 cm / 5 1/8"



1/2  
 286-03-13  
 13 cm / 5 1/8"

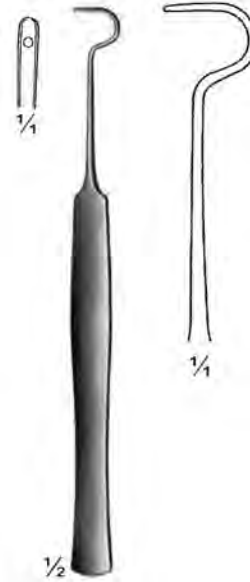

1/2  
 286-04-15  
 15 cm / 6"

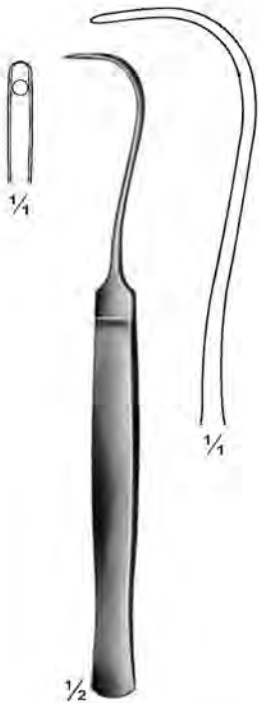

1/2  
 Syme  
 286-05-17  
 17 cm / 6 3/4"

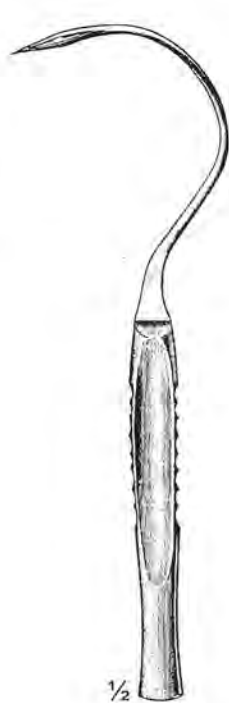

1/2  
 Craft  
 286-06-19  
 19 cm / 7 1/2"

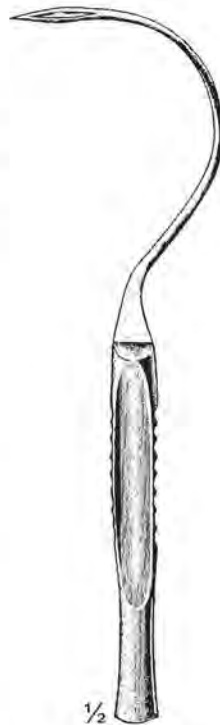

1/2  
 Craft  
 286-07-19  
 19 cm / 7 1/2"



1/2  
 Craft  
 286-08-19  
 19 cm / 7 1/2"

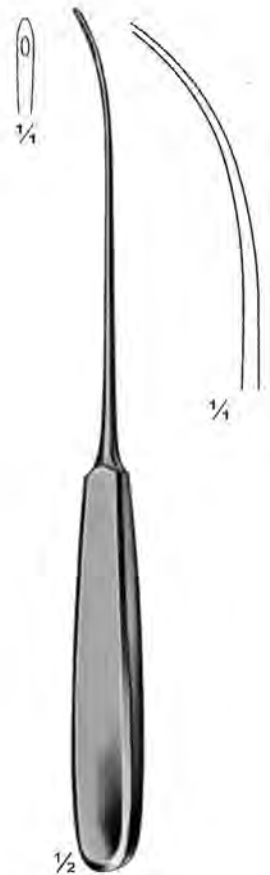

1/2  
 286-09-23  
 23 cm / 9"

Führungshohlsonden ; Sondas conductoras  
 Ligature Conductors ; Sonde conduttive  
 Sondas conductrices ; Sondas conductivas

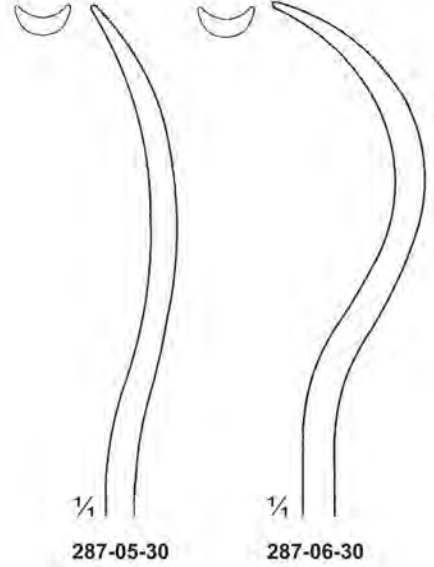
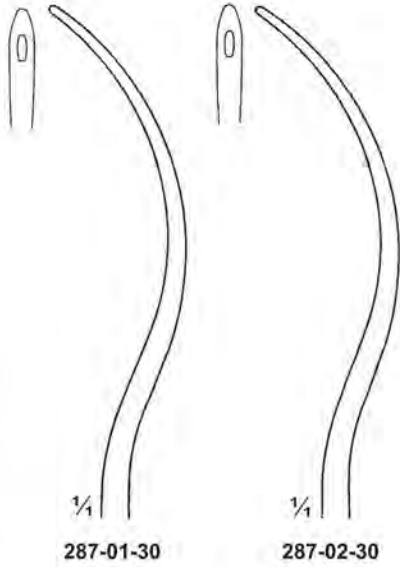

Brunner  
 287-01-30 To 287-04-30  
 30 cm / 12"

Brunner  
 287-05-30 To 287-08-30  
 30 cm / 12"  
 Guiding probes



**Führungshohlsonden ; Sondas conductoras  
Ligature Conductors ; Sonde conduttive  
Sondes conductrices ; Sondas conductivas**

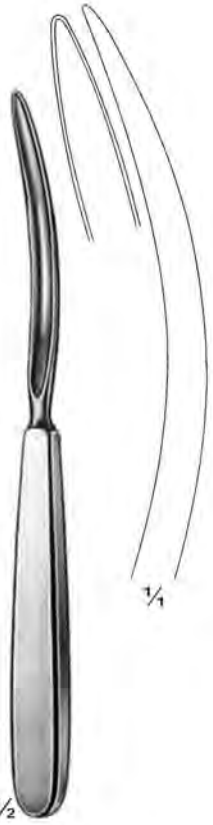

**288-01-19**  
19 cm / 7 1/2"

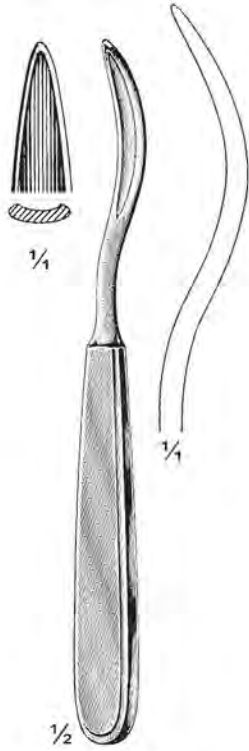

**Schmieden**  
**288-02-19**  
19 cm / 7 1/2"

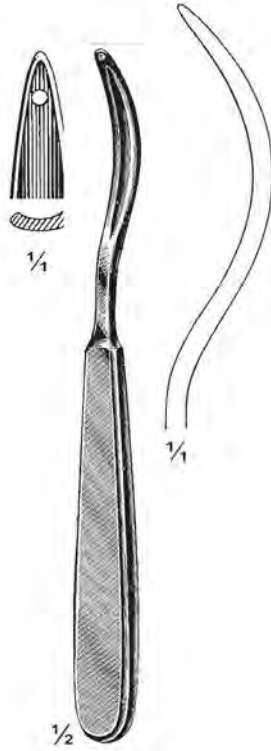

**Schmieden-Payr**  
**288-03-19**  
19 cm / 7 1/2"



**Koenig**  
**288-04-20**  
20 cm / 8"

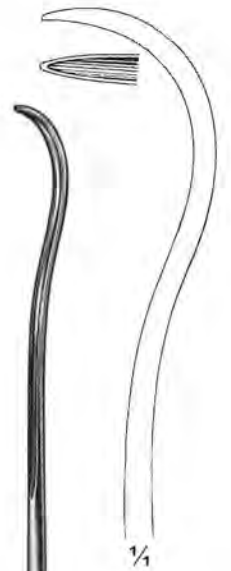

**288-09-28**  
28 cm / 11"

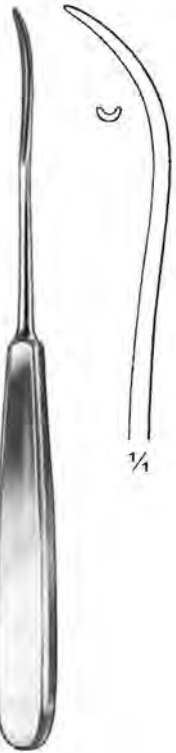

**Koenig**  
**288-05-19**  
19.5 cm / 7 3/4"

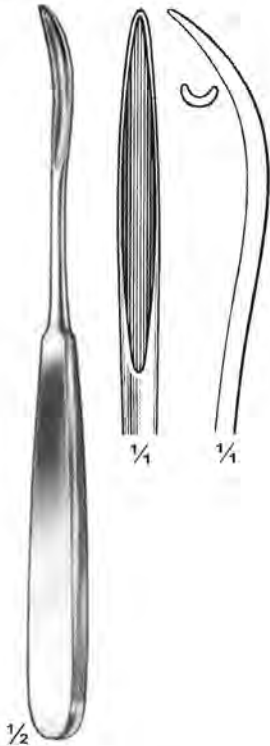

**Koenig**  
**288-06-19**  
19.5 cm / 7 3/4"

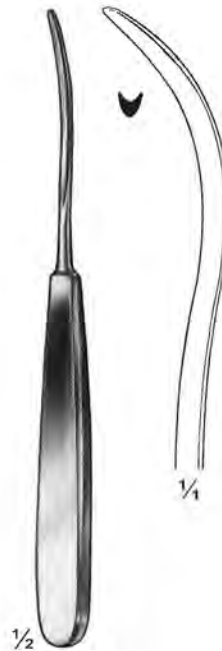

**288-07-17**  
17 cm / 6 3/4"



**Stille**  
**288-08-19**  
19 cm / 7 1/2"

Führungshohlsonden ; Sondas conductoras  
 Ligature Conductors ; Sonde conduttive  
 Sondas conductrices ; Sondas conductivas



1/2  
 Kocher  
 289-01-15  
 15 cm / 6"



1/2  
 Kocher  
 289-02-17  
 17 cm / 6 3/4"

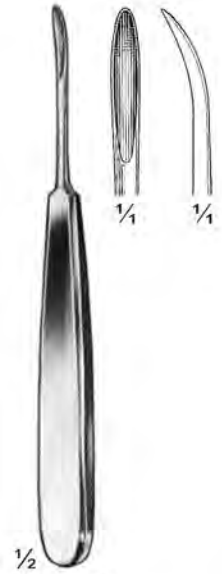

1/2  
 289-03-15  
 15 cm / 6"

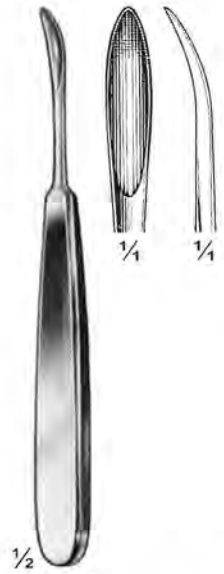

1/2  
 289-04-15  
 15 cm / 6"



1/2  
 289-05-20  
 20 cm / 8"



1/2  
 Payr  
 289-06-19  
 19.5 cm / 7 3/4"

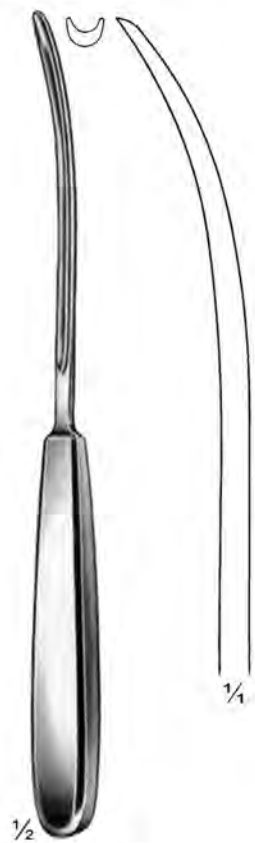

1/2  
 Payr  
 289-07-22  
 22.5 cm / 9"



1/2  
 Hofmeister  
 289-08-21  
 21 cm / 8 1/4"



1/2  
 Ferrozell  
 289-09-24  
 24 cm / 9 1/2"

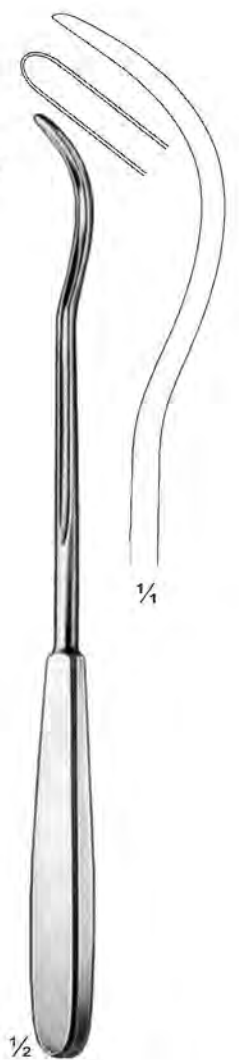

1/2  
 Kirschner  
 289-10-25  
 25.5 cm / 10 1/8"

Führungshohlsonden ; Sondas conductoras  
 Ligature Conductors ; Sonde conduttive  
 Sondas conductrices ; Sondas conductivas

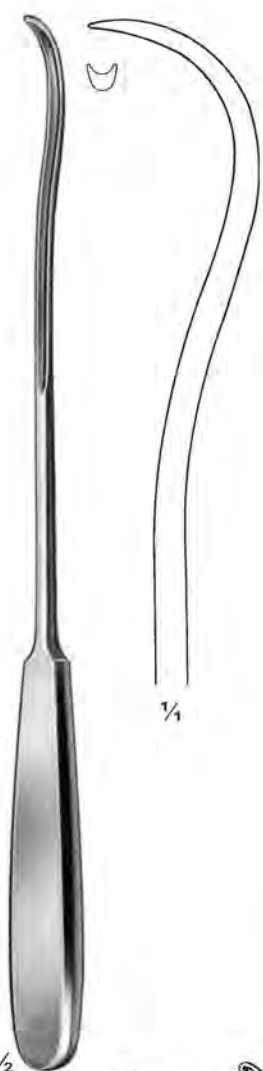

1/2  
**290-01-28**  
 28 cm / 11"

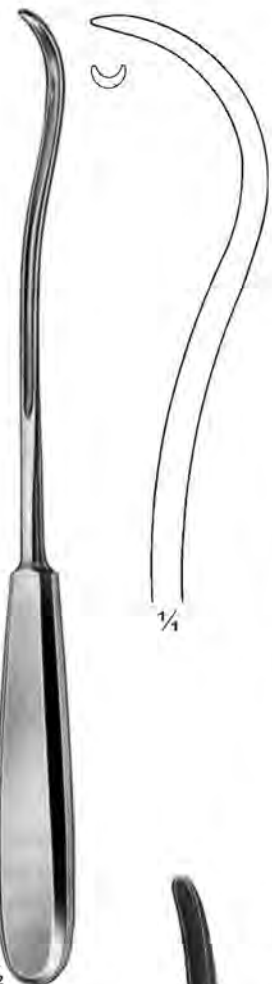

1/2  
 Kirschner  
**290-02-25**  
 25 cm / 10"

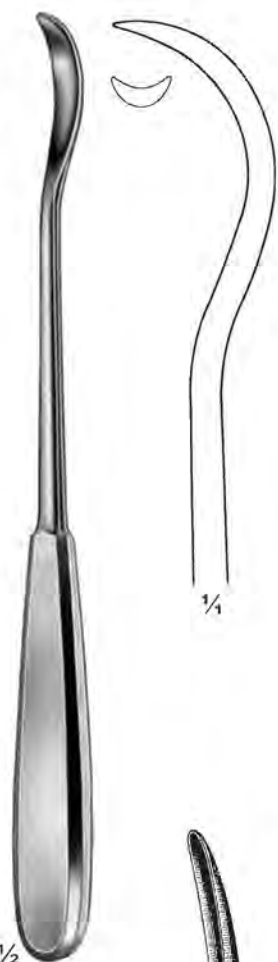

1/2  
 Brunner  
**290-03-24**  
 24.5 cm / 9 3/4"

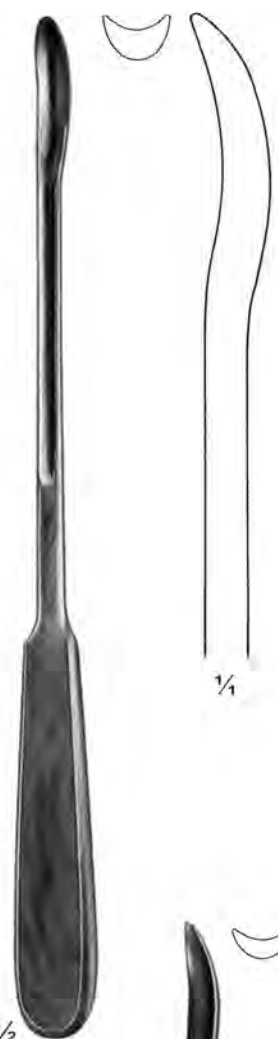

1/2  
**290-04-18**  
 18.5 cm / 7 1/4"

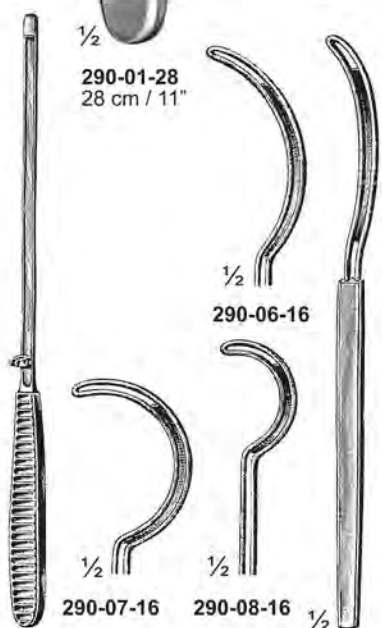

Lebsche  
**290-05-25**  
 25 cm / 10"

Braatz Krause  
**290-06-16 To 290-08-16**  
 16 cm / 6 1/4"



1/2  
**290-09-18**  
 18.5 cm / 7 1/4"



1/2  
 Ferrozel  
**290-10-18** Str  
**290-11-18** Cur  
 18 cm / 7"

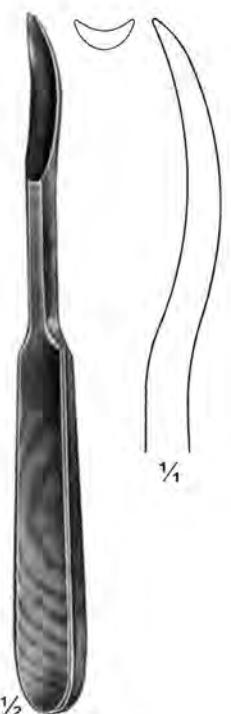

1/2  
**290-12-18**  
 18.5 cm / 7 1/4"

**Naht-Instrumente ; Instrumentos para sutura  
Suture Instruments ; Strumenti per sutura  
Instruments de suture ; Instrumentos de sutura**



$\frac{1}{2}$   
Wiener Modell  
**291-01-23**  
23.5 cm / 9 $\frac{1}{4}$ "  
Suture hook



$\frac{1}{2}$   
Henton  
**291-02-20**  
20 cm / 8"

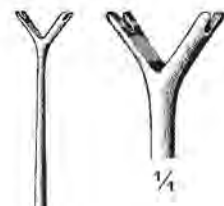

La Force  
**291-03-19**  
19 cm / 7 $\frac{1}{2}$ "



$\frac{1}{2}$   
Caspar  
**291-04-23**  
23 cm / 9"  
Knot tier and  
ligature adjuster



**291-05-23**  
23 cm / 9"



$\frac{1}{2}$   
Friedrich  
**291-06-16**  
16.5 cm / 6 $\frac{1}{2}$ "  
Ligature carrier



$\frac{1}{2}$   
Bozemann  
**291-07-22**  
22 cm / 8 $\frac{3}{4}$ "  
Suture hook and  
knot tier



Bozemann  
**291-08-22**  
22 cm / 8 $\frac{3}{4}$ "  
Suture hook and  
knot tier

**Naht-Instrumente ; Instrumentos para sutura  
Suture Instruments ; Strumenti per sutura  
Instruments de suture ; Instrumentos de sutura**



Michel  
292-01-12  
12 cm / 4¾"



Wachenfeldt  
292-02-12  
12.5 cm / 5"



Hegenbarth  
292-03-12  
12.5 cm / 5"



Ochsner  
292-04-14  
14 cm / 5½"



Child  
292-05-17  
17 cm / 6¾"

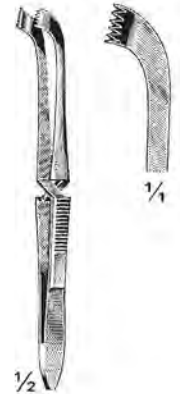

Lange  
292-06-10  
10 cm / 4"



292-07-15  
15 cm / 6"



292-08-15 15 cm / 6"  
292-09-18 18 cm / 7"



Michel  
292-10-13  
13 cm / 5¼"



Wachenfeldt  
292-11-12  
12 cm / 4¾"  
With clip holder



Child  
292-12-14  
14.5 cm / 5¾"  
With clip holder



Child  
292-13-18  
18 cm / 7"  
With clip holder

**Naht-Instrumente ; Instrumentos para sutura  
Suture Instruments ; Strumenti per sutura  
Instruments de suture ; Instrumentos de sutura**

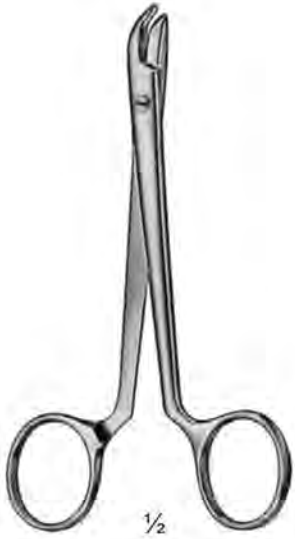

Collin  
293-01-13  
13.5 cm / 5 1/4"



Heath  
293-02-13  
13.5 cm / 5 1/4"



293-03-14  
14 cm / 5 1/2"

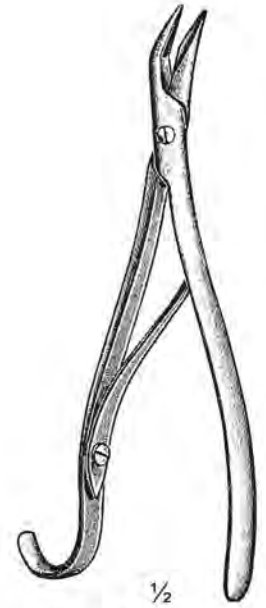

Braith-Waite  
293-04-16 16 cm / 6 1/4"  
293-05-17 17 cm / 6 3/4"



Michel  
293-06-12  
12.5 cm / 5"



Michel Modif.  
293-07-13  
13 cm / 5 1/8"  
One blade serrated

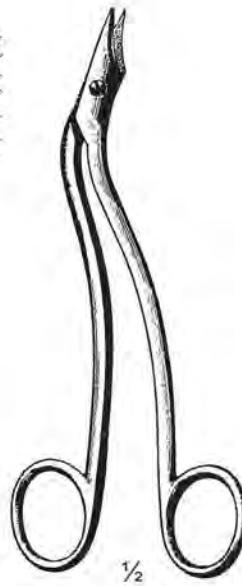
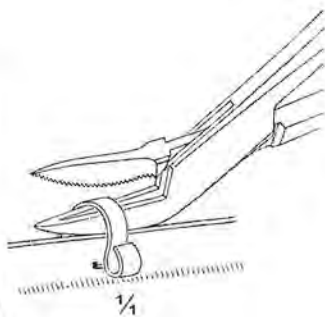

Heath  
293-08-15  
15 cm / 6"  
One blade serrated

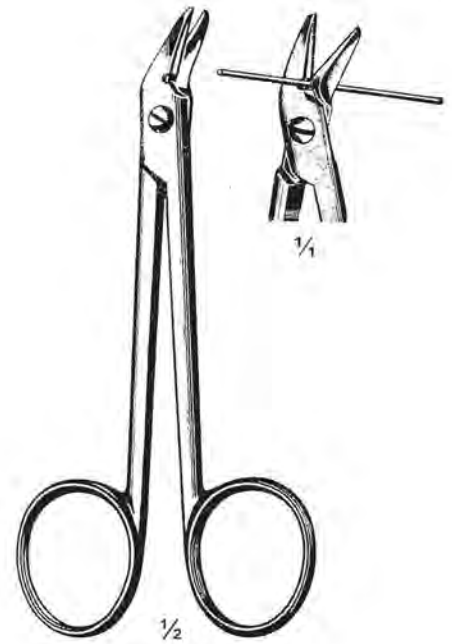

Universal  
293-09-12  
12 cm / 4 3/4"

**Naht-Instrumente ; Instrumentos para sutura  
Suture Instruments ; Strumenti per sutura  
Instruments de suture ; Instrumentos de sutura**

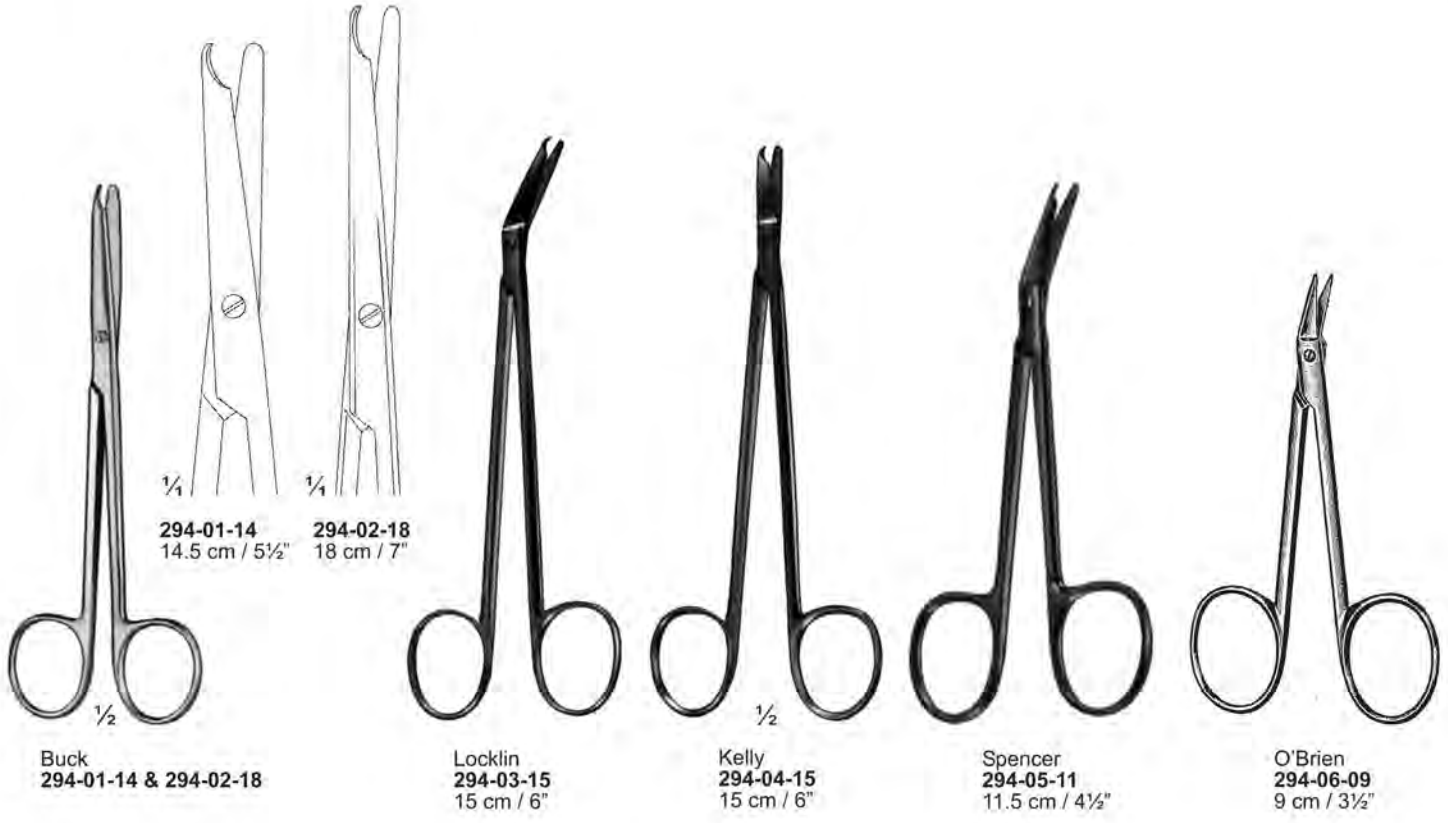

**Nahtbesteck ; Estuche de agrafes y de bolsillo  
Suture Sets ; Astucci tascabili e per sutura  
Trousse à suture ; Kit de Instrumentos de sutura**



Michel

**295-01-00**

Suture set in case consisting of :

- 1 Clip applying forceps
- 1 Clip applying and removing forceps
- 1 Clip holder
- 25 Michel clips



**295-02-00**

Suture set in case consisting of :

- 1 Scissors, cur, sh/sh, 11.5 cm
- 1 Michel clip applying and removing forceps
- 25 Michel clips, 16 X 3 mm
- 1 Delicate tissue forceps, 13 cm
- 1 Scalpel, bellied
- 1 Mathieu needle holder, 14 cm
- 1 Perforated metal case, stainless
- 1 Suture needle

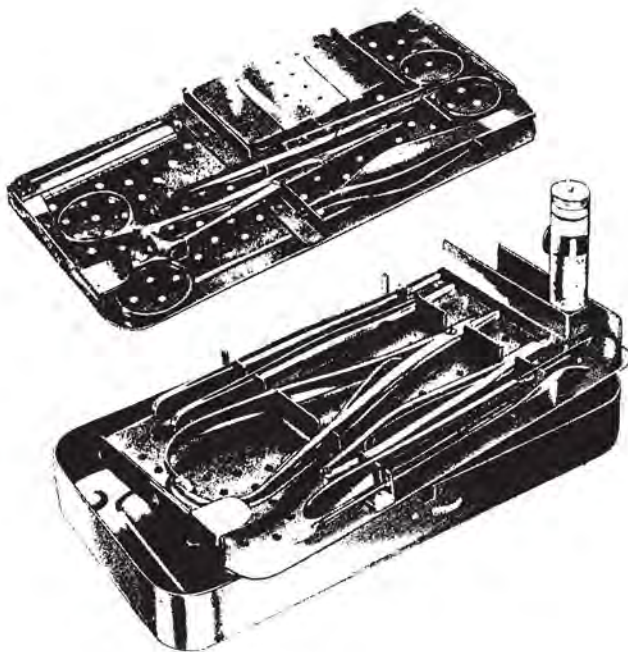

**295-03-00**

Complete in metal case with plastic pouch and 2 removable perforated trays consisting :

- 1 Mathieu needle holder, 17 cm
- 1 Flacon with sterilized silk in alcohol
- 6 Suture needles assorted
- 1 Needle case, 65 X 42 mm, perforated
- 1 Michel suture clip forceps
- 20 Michel suture clips with clip holder
- 1 Scalpel handle with blade
- 3 Scalpel blades, interchangeable
- 1 Scissor, str, bl/sh, 14.5 cm
- 1 Dressing forceps, 14.5 cm
- 1 Tissue forceps, 1 X 2 Teeth, 14.5 cm
- 1 Feilchenfeld splinter forceps, 11.5 cm
- 1 Kocher artery forceps, 14 cm
- 1 Probe with myrtle leaf, 13 cm



Assistant Standard

**295-04-00**

Complete in metal case with plastic pouch and 2 removable perforated trays consisting :

- 1 Mathieu needle holder, 14 cm
- 1 Flacon with sterilized silk in alcohol
- 6 Suture needles assorted
- 1 Needle case, 65 X 42 mm, perforated
- 1 Michel suture clip forceps
- 20 Michel suture clips with clip holder
- 1 Scalpel handle with blade
- 3 Scalpel blades, interchangeable
- 1 Scissor, str, bl/sh, 13 cm
- 1 Dressing forceps, 11.5cm
- 1 Tissue forceps, 1 X 2 Teeth, 12 cm
- 1 Hunter splinter forceps, 10.5 cm
- 1 Kocher artery forceps, str, 13 cm
- 1 Probe with myrtle leaf, 13 cm



**Nahtbesteck ; Estuche de agrafes y de bolsillo**  
**Suture Sets ; Astucci tascabili e per sutura**  
**Trousse à suture ; Kit de Instrumentos de sutura**

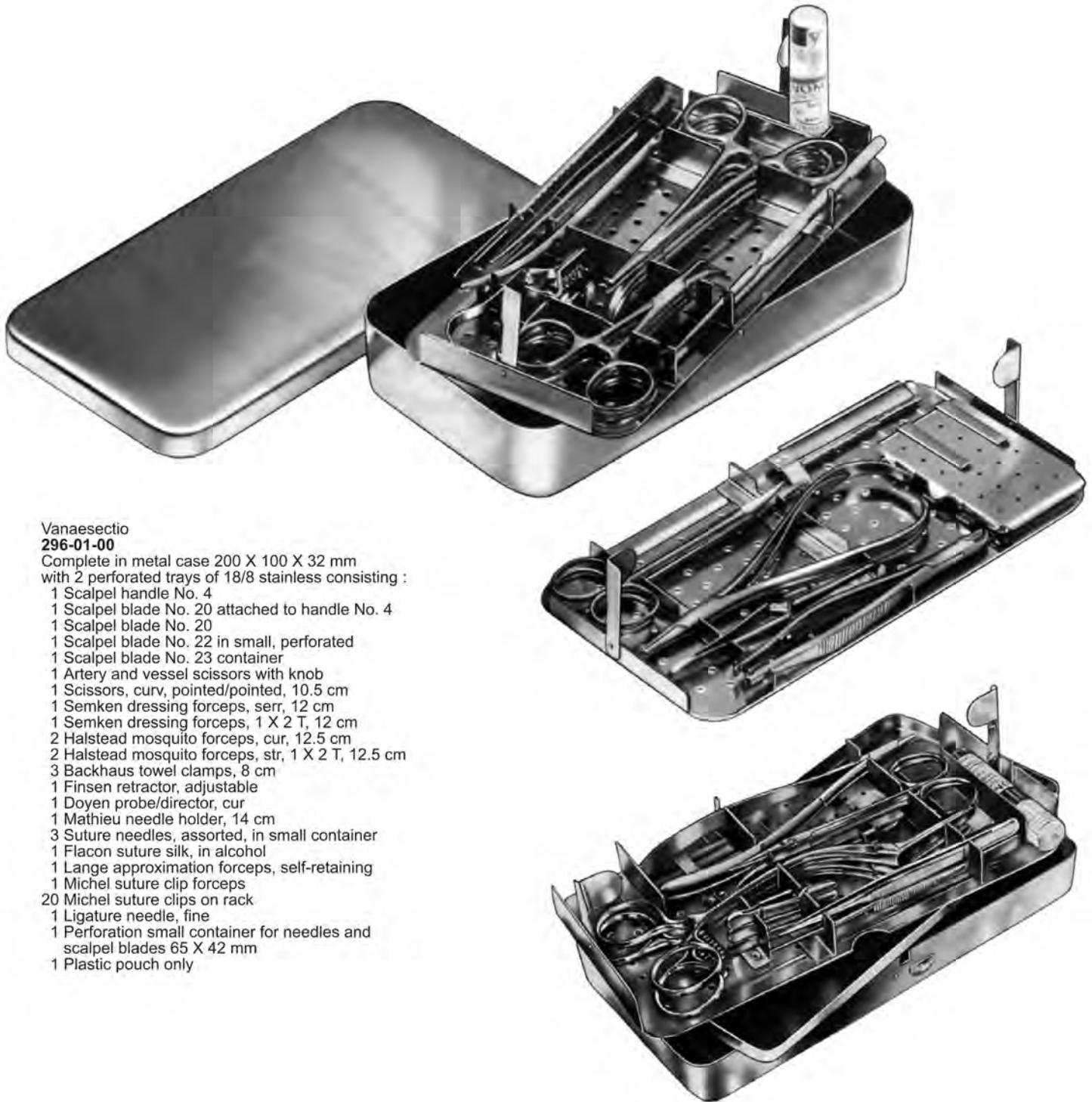

**Vanaeseccio**

**296-01-00**

Complete in metal case 200 X 100 X 32 mm  
 with 2 perforated trays of 18/8 stainless consisting :

- 1 Scalpel handle No. 4
- 1 Scalpel blade No. 20 attached to handle No. 4
- 1 Scalpel blade No. 20
- 1 Scalpel blade No. 22 in small, perforated
- 1 Scalpel blade No. 23 container
- 1 Artery and vessel scissors with knob
- 1 Scissors, curv, pointed/pointed, 10.5 cm
- 1 Semken dressing forceps, serr, 12 cm
- 1 Semken dressing forceps, 1 X 2 T, 12 cm
- 2 Halstead mosquito forceps, cur, 12.5 cm
- 2 Halstead mosquito forceps, str, 1 X 2 T, 12.5 cm
- 3 Backhaus towel clamps, 8 cm
- 1 Finsen retractor, adjustable
- 1 Doyen probe/director, cur
- 1 Mathieu needle holder, 14 cm
- 3 Suture needles, assorted, in small container
- 1 Flacon suture silk, in alcohol
- 1 Large approximation forceps, self-retaining
- 1 Michel suture clip forceps
- 20 Michel suture clips on rack
- 1 Ligature needle, fine
- 1 Perforation small container for needles and scalpel blades 65 X 42 mm
- 1 Plastic pouch only

**296-02-00**

Complete in metal case 200 X 100 X 25 mm, with 1 plastic pouch and 1 perforated trays consisting :

**Nahtbesteck ; Estuche de agrafes y de bolsillo**  
**Suture Sets ; Astucci tascabili e per sutura**  
**Trousse à suture ; Kit de Instrumentos de sutura**

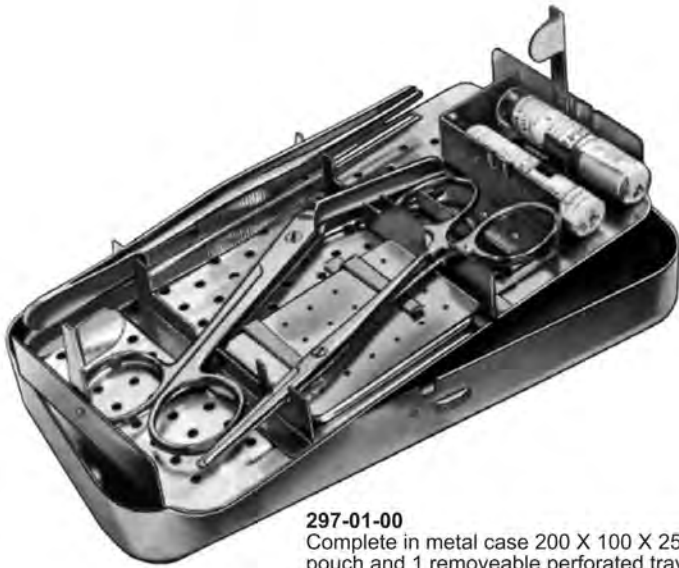

**297-01-00**

Complete in metal case 200 X 100 X 25 mm, with plastic pouch and 1 removeable perforated tray consisting :

- 1 Perineum (Episiotomy) scissors, 14.5 cm
- 1 Needle holder mathieu, 20 cm
- 1 Operating scissors, str, bl/sh, 14.5 cm
- 1 Kocher hemostatic forceps, 14.5 cm
- 1 Dressing forceps, 16 cm
- 1 Tissue forceps, 1 X 2 T, 16 cm
- 6 Suture needles, assorted
- 1 Needle case 65 X 42 mm, perforated
- 1 Flacon suture silk in alcohol
- 1 Flacon catgut in alcohol

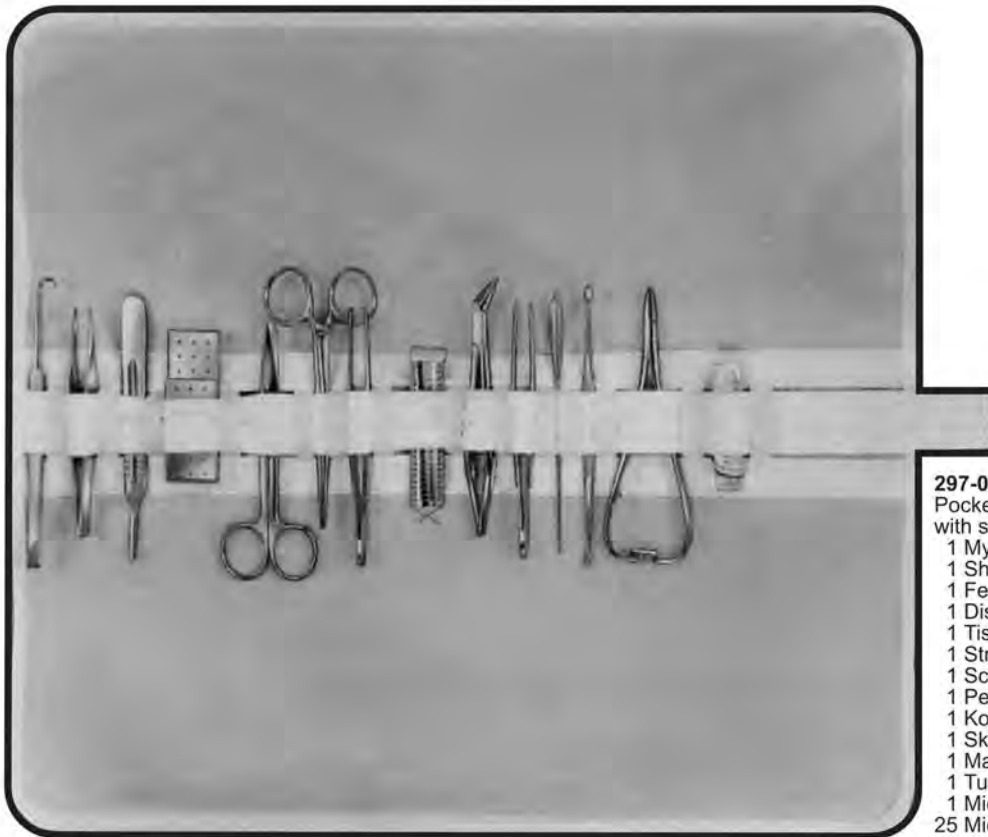

**297-02-00**

Pocket instrument set in metal case 170 X 90 mm, with sterilizable canvas roll consisting :

- 1 Myrtle leaf probe, 13 cm
- 1 Sharp double curette
- 1 Feilchenfeld splinter forceps, 11.5 cm
- 1 Dissecting forceps, 13 cm
- 1 Tissue forceps, 13 cm
- 1 Straight surgical scissors, 13 cm
- 1 Scalpel handle No. 4
- 1 Perforated metal case, containing 6 scalpel blades
- 1 Kocher hemostatic forceps, 13 cm
- 1 Skin hook
- 1 Mathieu needle holder, 14 cm
- 1 Tube of suture silk, sterile in alcohol
- 1 Michel clip forceps, 12 cm
- 25 Michel clips, 16 X 3 mm
- 1 Perforated metal case, stainless containing :
- 1 Suture needle
- 1 item
- 1 item

**Wundhaken ; Separadores  
Retractors ; Divaricatori  
Ecarteurs ; Afastadores**



1/4  
6 X 12 mm  
Masing  
298-01-14  
14 cm / 5 1/2"



298-02-20  
298-08-24  
9 X 8 mm



298-03-20  
298-09-24  
9 X 10 mm



298-04-20  
298-10-24  
9 X 12 mm



298-05-20  
298-11-24  
9 X 14 mm



298-06-20  
298-12-24  
9 X 16 mm



298-07-20  
298-13-24  
9 X 18 mm



1/2  
Cushing  
298-02-20 To 298-07-20  
20 cm / 8"



1/2  
Cushing  
298-08-24 To 298-13-24  
24 cm / 9 1/2"



1/4  
298-14-25  
11 X 14 mm

1/4  
298-15-25  
13 X 18 mm

1/4  
298-16-25  
15 X 22 mm



1/4  
298-17-23  
298-23-21  
9 x 8 mm

1/4  
298-18-23  
298-24-21  
9 x 10 mm

1/4  
298-19-23  
298-25-21  
9 x 12 mm

1/4  
298-20-23  
298-26-21  
9 x 14 mm

1/4  
298-21-23  
298-27-21  
9 x 16 mm

1/4  
298-22-23  
298-28-21  
9 x 18 mm



Cushing  
298-14-25 To 298-16-25  
25 cm / 10"

Cushing  
298-17-23 To 298-22-23  
23.5 cm / 9 1/4"

Cushing  
298-23-21 To 298-28-21  
21.5 cm / 8 1/4"

**Wundhaken ; Separadores  
Retractors ; Divaricatori  
Ecarteurs ; Afastadores**



1/4  
299-01-24  
299-07-24  
8 mm

1/4  
299-02-24  
299-08-24  
11 mm

1/4  
299-03-24  
299-09-24  
15 mm

1/4  
299-04-24  
299-10-24  
17 mm

1/4  
299-05-24  
299-11-24  
20 mm

1/4  
299-06-24  
299-12-24  
23 mm

1/2  
Gil-Vernet Type  
299-01-24 To 299-06-24  
24 cm / 9 1/2"

Cottle  
299-13-14  
14 cm / 5 1/2"

299-14-17  
17 cm / 6 3/4"

1/2  
Cushing Kocher  
299-15-18  
18 cm / 7"

1/4  
Gil-Vernet  
299-07-24 To 299-12-24  
24 cm / 9 1/2"

**Wundhaken ; Separadores  
Retractors ; Divaricatori  
Ecarteurs ; Afastadores**

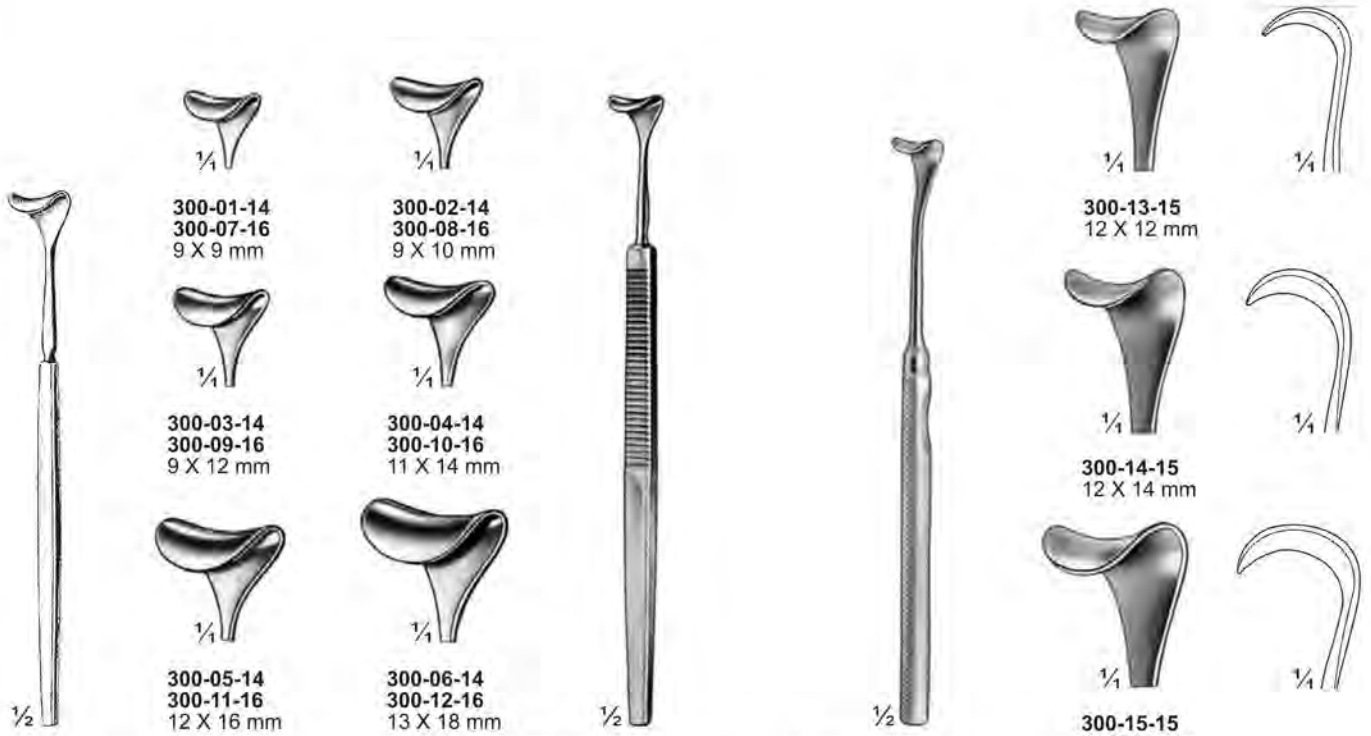

Desmarres  
300-01-14 To 300-06-14  
14 cm / 5 1/2"

Desmarres  
300-07-16 To 300-12-16  
16 cm / 6 1/4"

Mannerfelt Modif.  
300-13-15 To 300-15-15  
15 cm / 6"

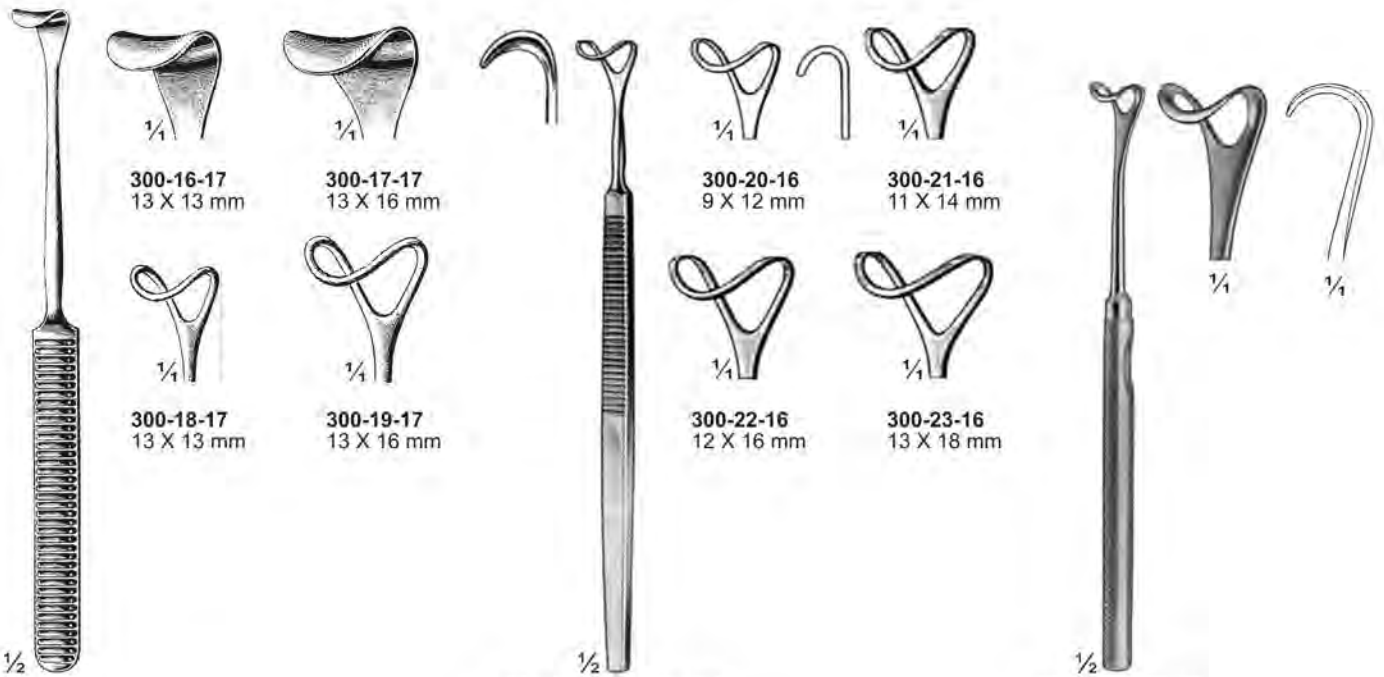

Koenig  
300-16-17 To 300-19-17  
17 cm / 6 3/4"

300-20-16 To 300-23-16  
16 cm / 6 1/4"

Mannerfelt Modif.  
300-24-15  
15 cm / 6"

**Wundhaken ; Separadores  
Retractors ; Divaricatori  
Ecarteurs ; Afastadores**



Mannerfelt Modif.  
301-01-15  
15 cm / 6"



Langenbeck-  
Mannerfelt Modif.  
301-02-15 To 301-05-15  
15 cm / 6"

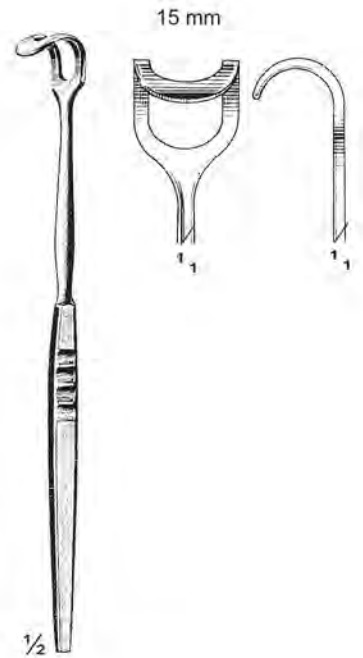

Handte  
301-06-17  
17 cm / 6 3/4"

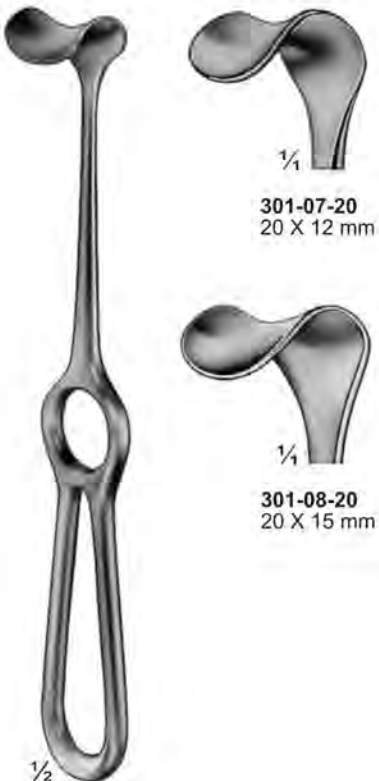

Kocher  
301-07-20 & 301-08-20  
20 cm / 8"



Little  
301-09-20  
20 cm / 8"



Schoenborn  
301-10-20  
20 cm / 8"  
13 X 6 mm



Cushing  
301-11-20  
20 cm / 8"



301-12-20  
20 cm / 8"



**Wundhaken ; Separadores  
Retractors ; Divaricatori  
Ecarteurs ; Afastadores**



**302-01-16**  
16 cm / 6 1/4"

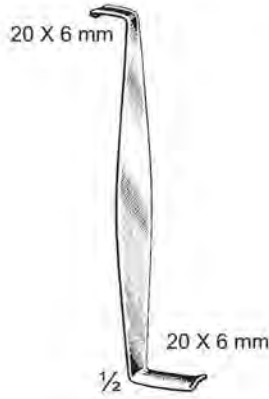

Crile  
**302-02-11**  
11 cm / 4 1/4"

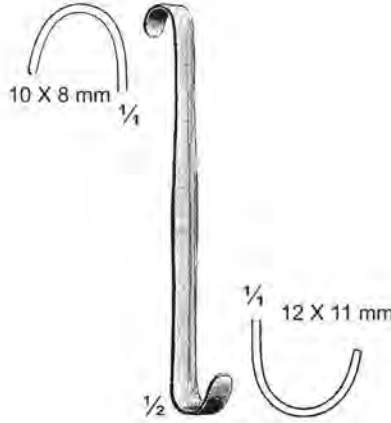

Luer  
**302-03-11**  
11 cm / 4 1/4"

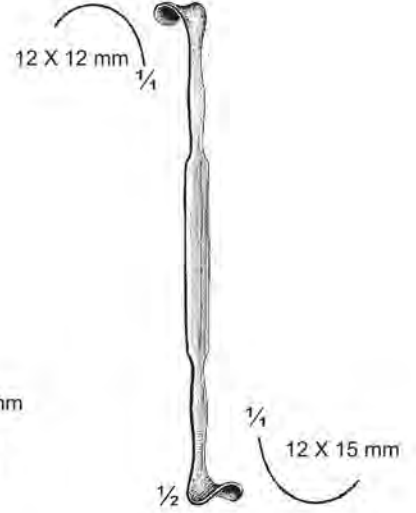

Rose  
**302-04-13**  
13 cm / 5 1/8"



Love (Morse)  
**302-05-25 To 302-10-25**  
25 cm / 10"

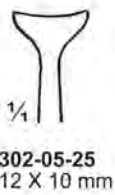

**302-05-25**  
12 X 10 mm

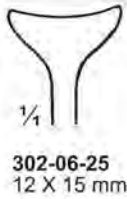

**302-06-25**  
12 X 15 mm

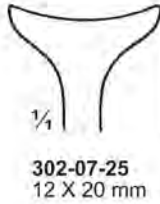

**302-07-25**  
12 X 20 mm



**302-08-25**  
12 X 30 mm



**302-09-25**  
15 X 40 mm

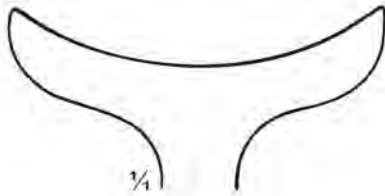

**302-10-25**  
15 X 50 mm

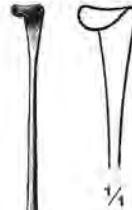

Love  
**302-11-00**  
19 cm / 7 1/2"



Love  
**302-12-45**  
19 cm / 7 1/2"  
45°



Love  
**302-90**  
19 cm / 7 1/2"  
90°

**Wundhaken ; Separadores  
Retractors ; Divaricatori  
Ecarteurs ; Afastadores**

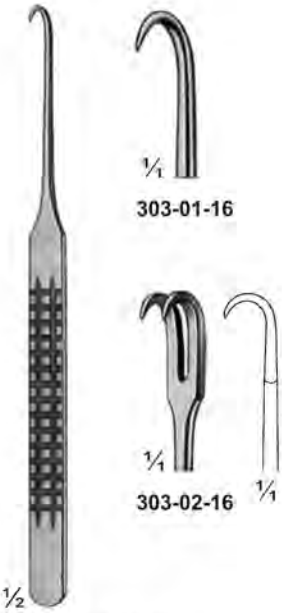

**303-01-16 & 303-02-16**  
16 cm / 6 1/4"

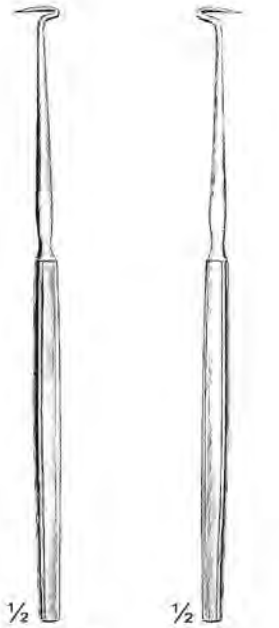

**Bose 303-03-16**  
16 cm / 6 1/4"

**Bose 303-04-16**  
16 cm / 6 1/4"



**303-05-16 To 303-08-16**  
16 cm / 6 1/4"

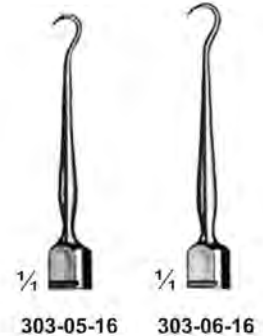

**303-05-16**

**303-06-16**

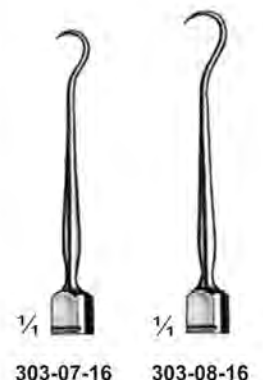

**303-07-16**

**303-08-16**



**Bergmann 303-09-14**  
14 cm / 5 1/2"



**Jackson 303-10-13**  
13 cm / 5 1/8"

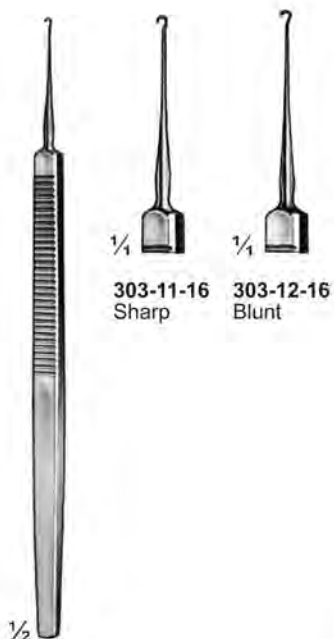

**Graefe 303-11-16 & 303-12-16**  
16 cm / 6 1/4"

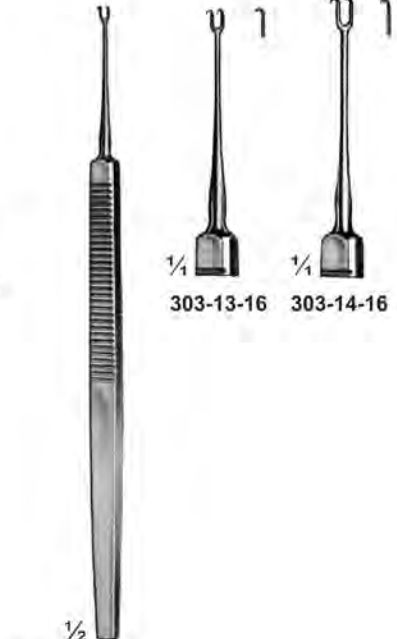

**Guthrie 303-13-16 & 303-14-16**  
16 cm / 6 1/4"



**O Conner 303-15-16**  
16 cm / 6 1/4"

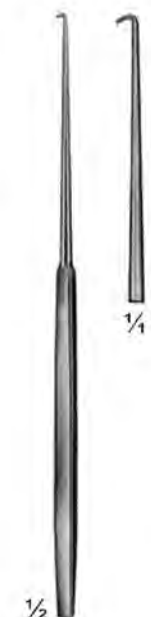

















**Cottle 303-16-16**  
16 cm / 6 1/4"



**Cottle 303-17-16**  
16 cm / 6 1/4"



**Wundhaken ; Separadores  
Retractors ; Divaricatori  
Ecarteurs ; Afastadores**

 <p style="text-align: center;"><math>\frac{1}{2}</math></p>	 <p style="text-align: center;"><math>\frac{1}{4}</math> 304-01-22</p>  <p style="text-align: center;"><math>\frac{1}{4}</math></p>  <p style="text-align: center;"><math>\frac{1}{4}</math> 304-02-22 304-03-22</p>  <p style="text-align: center;"><math>\frac{1}{4}</math></p>  <p style="text-align: center;"><math>\frac{1}{4}</math> 304-04-22 304-05-22</p>	 <p style="text-align: center;"><math>\frac{1}{2}</math></p>	 <p style="text-align: center;"><math>\frac{1}{2}</math></p>	 <p style="text-align: center;"><math>\frac{1}{2}</math></p>	 <p style="text-align: center;"><math>\frac{1}{2}</math></p>	 <p style="text-align: center;"><math>\frac{1}{2}</math> Toennis 304-15 15 cm / 6"</p>
<p>Emmet 304-01-22 To 304-05-22 22 cm / 8<math>\frac{3}{4}</math>"</p>	<p>Simon 304-06-22 22 cm / 8<math>\frac{3}{4}</math>"</p>	<p>Simon 304-07-22 22 cm / 8<math>\frac{3}{4}</math>"</p>	<p>Lange 304-08-23 23 cm / 9"</p>	<p>Moldestad 304-09-11 &amp; 304-10-11 11.5 cm / 4<math>\frac{1}{2}</math>"</p>	<p>304-09 <math>\frac{1}{4}</math></p> <p>304-10-15 <math>\frac{1}{4}</math></p>	<p>304-18-16 <math>\frac{1}{1}</math></p> <p>304-19-16 <math>\frac{1}{1}</math> 2 mm</p> <p>304-20-16 <math>\frac{1}{1}</math> 5 mm</p> <p>304-21-16 <math>\frac{1}{1}</math> 7 mm</p> <p>304-22-16 <math>\frac{1}{1}</math> 10 mm</p>
 <p style="text-align: center;"><math>\frac{1}{2}</math></p>	 <p style="text-align: center;"><math>\frac{1}{2}</math></p>	 <p style="text-align: center;"><math>\frac{1}{2}</math></p>	 <p style="text-align: center;"><math>\frac{1}{2}</math></p>	 <p style="text-align: center;"><math>\frac{1}{2}</math></p>	 <p style="text-align: center;"><math>\frac{1}{2}</math></p>	<p>304-15 <math>\frac{1}{1}</math></p> <p>304-16-18 <math>\frac{1}{1}</math></p>
<p>Fisch 304-12-18 18.5 cm / 7<math>\frac{1}{4}</math>"</p>	<p>Fisch 304-13-18 18.5 cm / 7<math>\frac{1}{4}</math>"</p>	<p>Kilner 304-14-15 15 cm / 6"</p>	<p>Gillies 304-15-18 &amp; 304-16-18 18 cm / 7"</p>	<p>Freer 304-17-15 15 cm / 6"</p>	<p>Joseph 304-18-16 To 304-22-16 16 cm / 6<math>\frac{1}{4}</math>"</p>	<p>304-16-18 <math>\frac{1}{1}</math></p>

**Wundhaken ; Separadores  
Retractors ; Divaricatori  
Ecarteurs ; Afastadores**

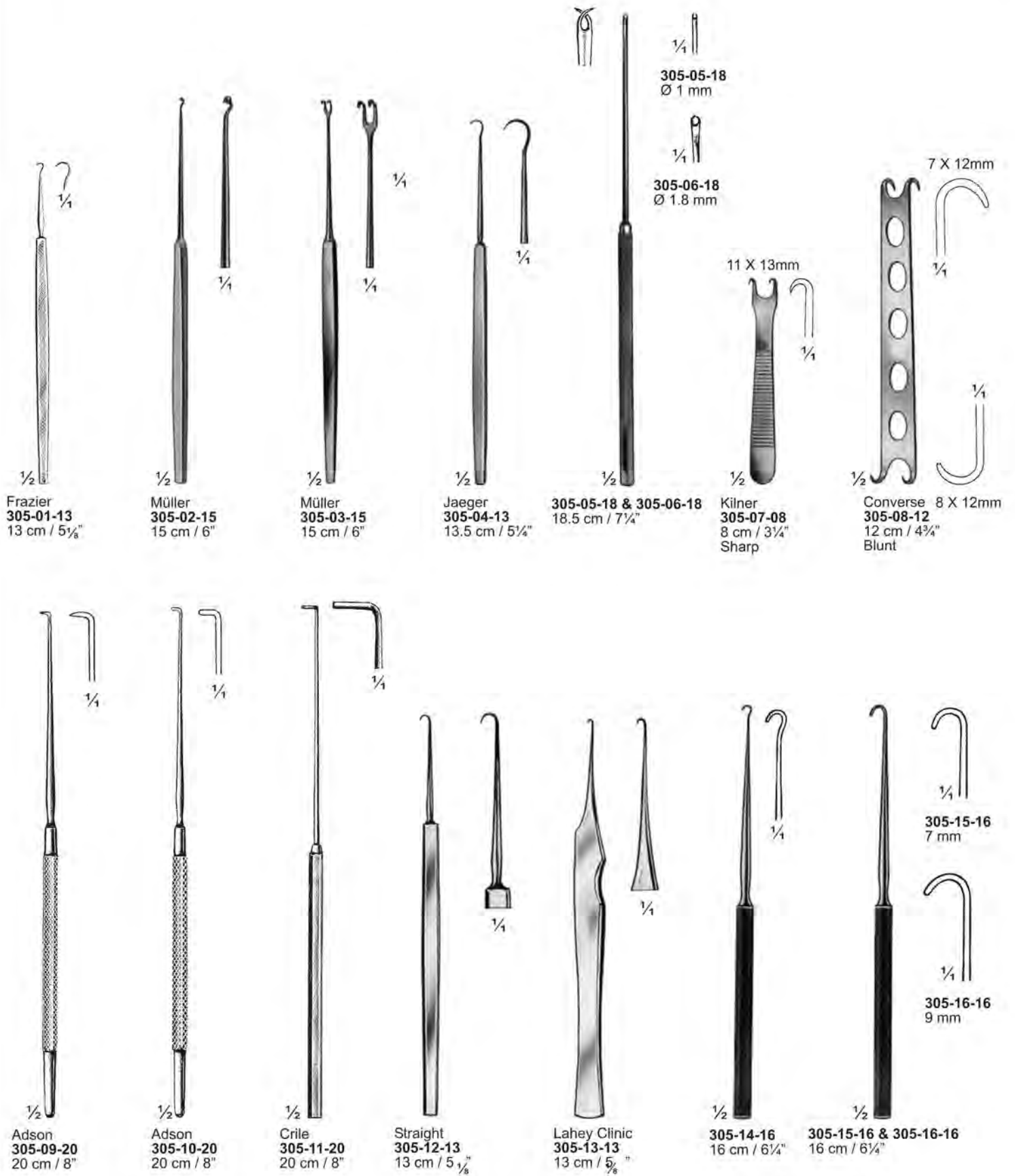

**Wundhaken ; Separadores  
Retractors ; Divaricatori  
Ecarteurs ; Afastadores**

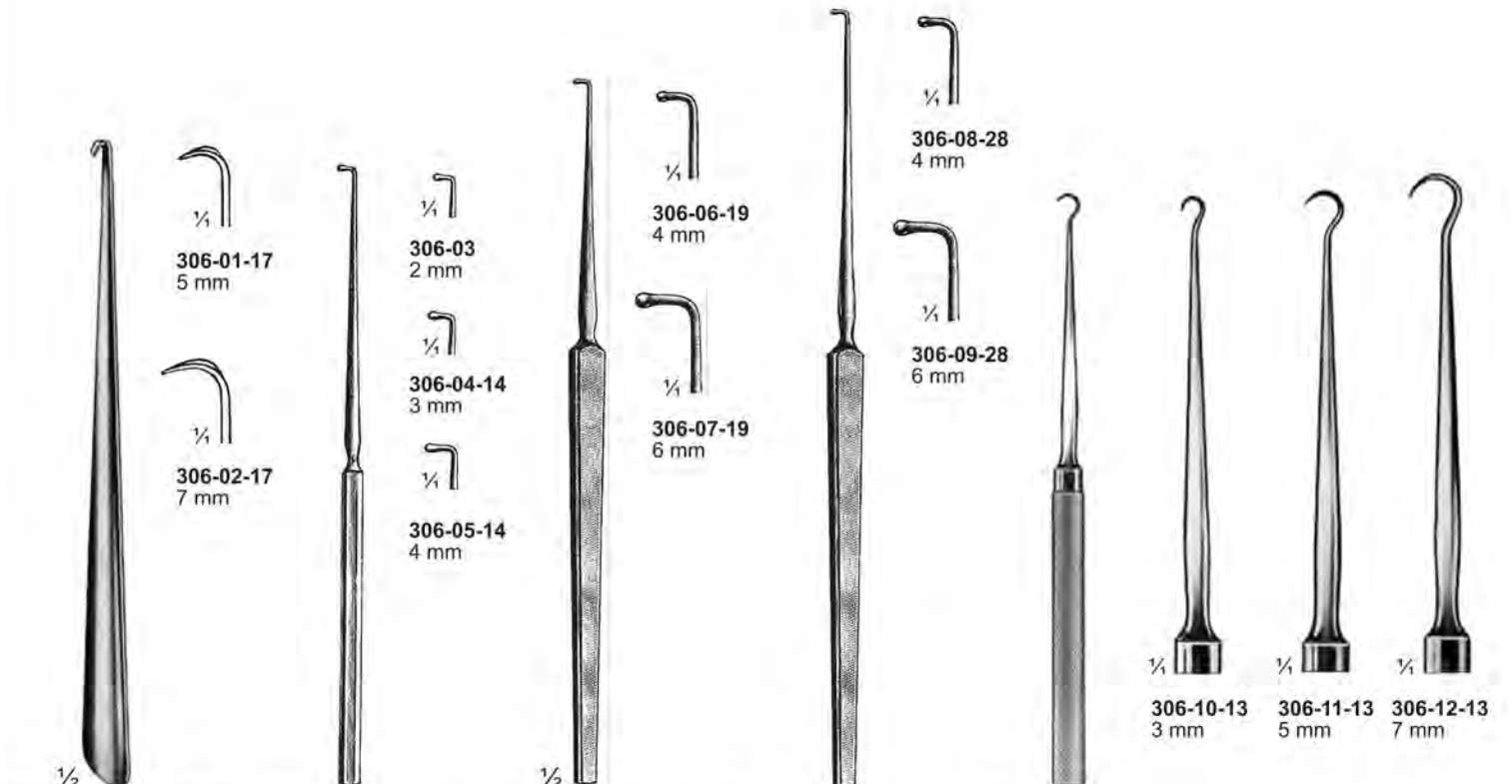

**306-01-17** 5 mm  
**306-02-17** 7 mm  
**306-03** 2 mm  
**306-04-14** 3 mm  
**306-05-14** 4 mm  
**306-06-19** 4 mm  
**306-07-19** 6 mm  
**306-08-28** 4 mm  
**306-09-28** 6 mm  
**306-10-13** 3 mm  
**306-11-13** 5 mm  
**306-12-13** 7 mm

**306-01-17 & 306-02-17** 17 cm / 6 3/4"  
**Lucae 306-03-14 To 306-05-14** 14 cm / 5 1/2"  
**Cushing 306-06-19 & 306-07-19** 19 cm / 7 1/2"  
**Cushing 306-08-28 & 306-09-28** 28 cm / 11"  
**Kleinert-Kutz 306-10-13 To 306-12-13** 13 cm / 5 1/8"



**306-13-15**  
**306-14-15**  
**306-15-11**  
**306-16-15**  
**306-17-16**  
**306-18-18** Sharp  
**306-19-18** Blunt  
**306-20-18** Blunt

**Barsky 306-13-15** 15 cm / 6"  
**Barsky 306-14-15** 15 cm / 6"  
**Humby 306-15-11** 11.5 cm / 4 1/2"  
**News 306-16-15** 15 cm / 6"  
**306-17-16** 16.5 cm / 6 1/2"  
**306-18-18 To 306-20-18** 18 cm / 7"



**Wundhaken ; Separadores  
Retractors ; Divaricatori  
Ecarteurs ; Afastadores**

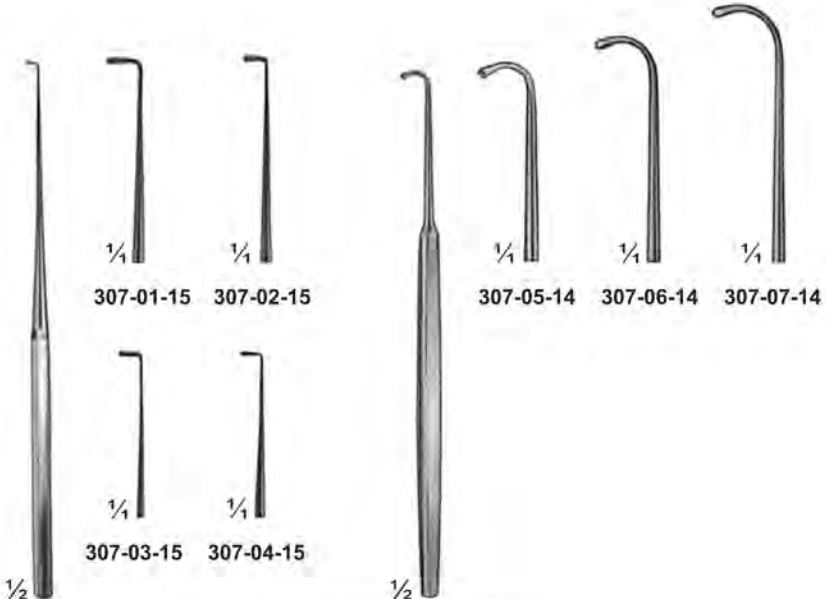

**Wagener**  
307-01-15 To 307-04-15  
15 cm / 6"

**Graefe**  
307-05-14 To 307-07-14  
14 cm / 5 1/2"

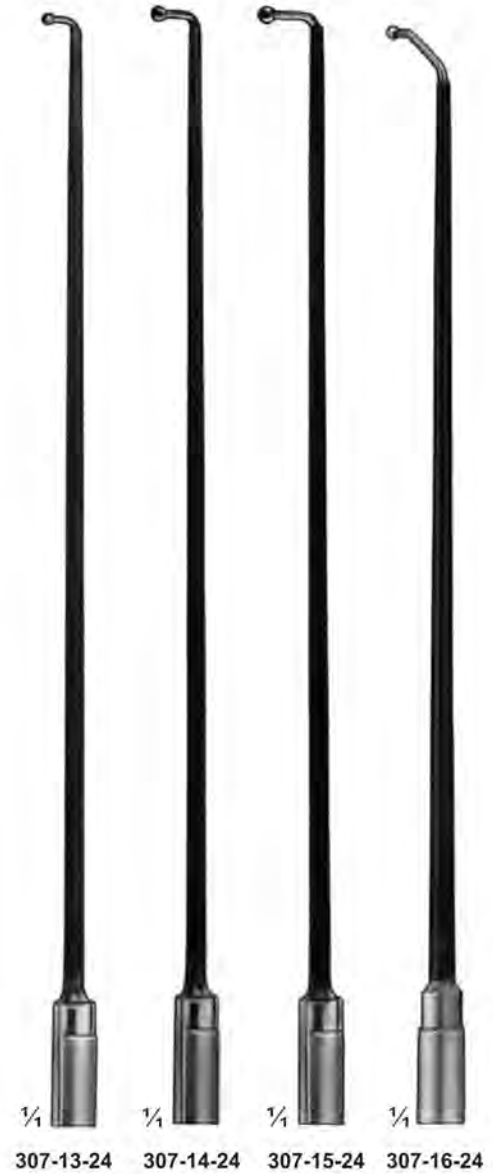

307-13-24 307-14-24 307-15-24 307-16-24

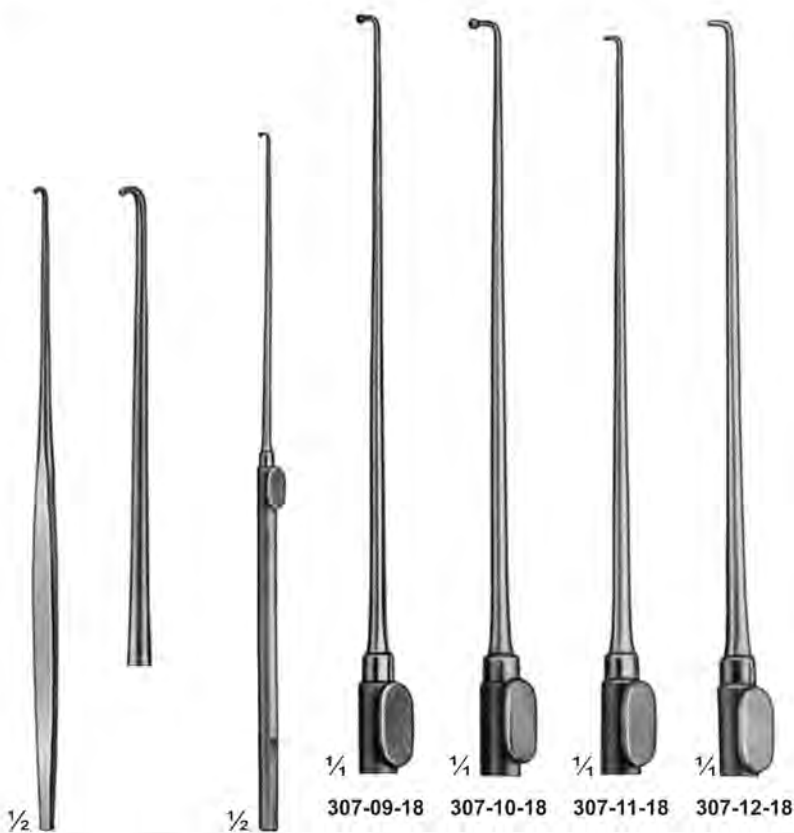

**Brom**  
307-08-17  
17 cm / 6 3/4"

**Krayenbühl**  
307-09-18 To 307-12-18  
18.5 cm / 7 1/4"

**Caspar**  
307-13-24 To 307-16-24  
24.5 cm / 9 3/4"



**Wundhaken ; Separadores  
Retractors ; Divaricatori  
Ecarteurs ; Afastadores**



Mannerfelt Modif.  
**308-01-13**  
13.5 cm / 5 1/4"  
Sharp



Mannerfelt Modif.  
**308-02-15**  
15 cm / 6"  
Sharp



Mannerfelt Modif.  
**308-03-15**  
15 cm / 6"  
Sharp



Jackson  
**308-04-17**  
17 cm / 6 3/4"



Cope  
**308-05-18**  
18 cm / 7"



Lukens  
**308-06-17**  
17 cm / 6 3/4"



Luer  
**308-07-11**  
11 cm / 4 1/4"

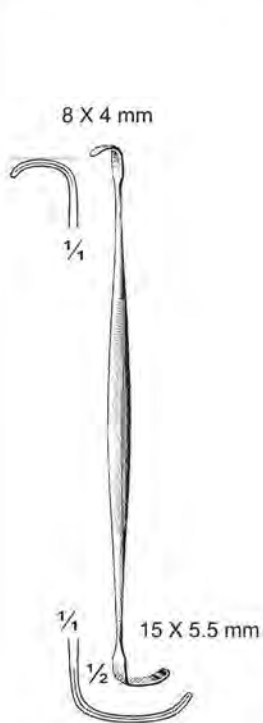

8 X 4 mm

1/4

15 X 5.5 mm

Ragnell-Davis  
**308-08-14**  
14 cm / 5 1/2"

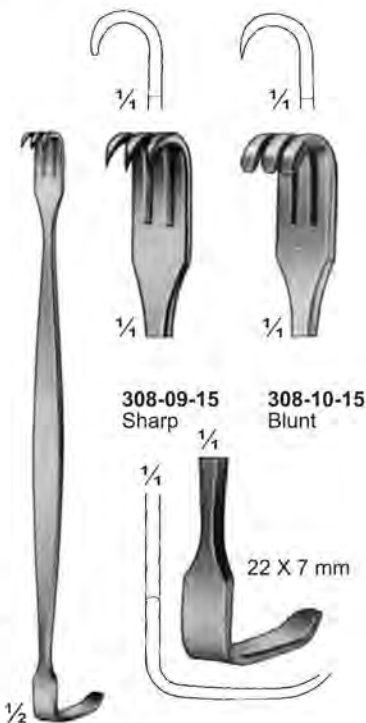

**308-09-15**  
Sharp

**308-10-15**  
Blunt

22 X 7 mm

Baby-Senn-Miller  
**308-09-15 & 308-10-15**  
15 cm / 6"

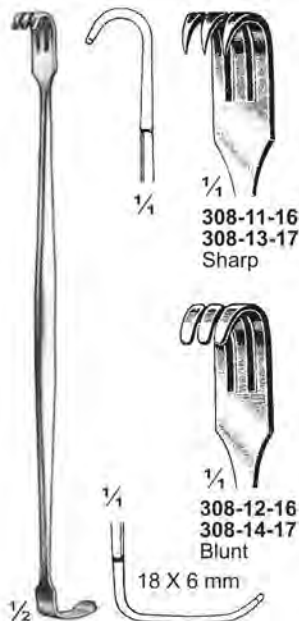

**308-11-16**  
**308-13-17**  
Sharp

**308-12-16**  
**308-14-17**  
Blunt

18 X 6 mm

Senn-Miller  
**308-11-16 & 308-12-16**  
16 cm / 6 1/4"

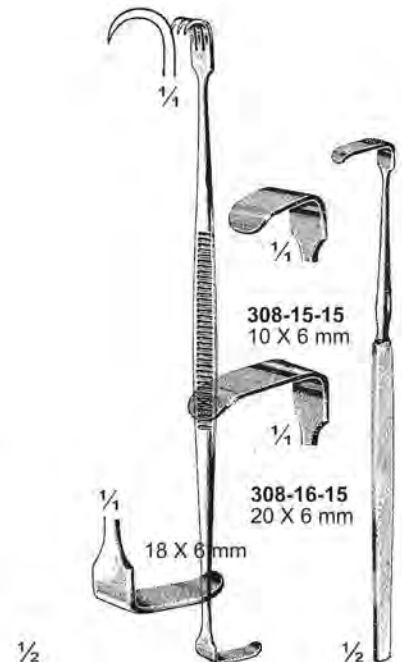

**308-15-15**  
10 X 6 mm

**308-16-15**  
20 X 6 mm

18 X 6 mm

Senn-Miller  
**308-13-17 & 308-14-17**  
17 cm / 6 3/4"

Senn-Green  
**308-15-15 & 308-16-15**  
15 cm / 6"

**Wundhaken ; Separadores  
Retractors ; Divaricatori  
Ecarteurs ; Afastadores**

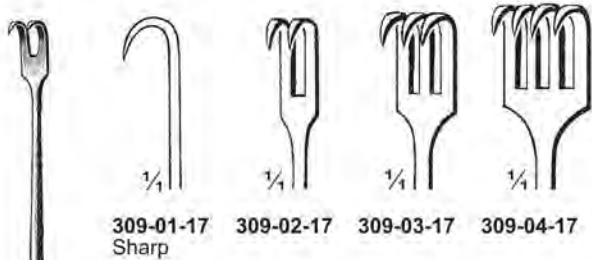

309-01-17 Sharp  
309-02-17  
309-03-17  
309-04-17

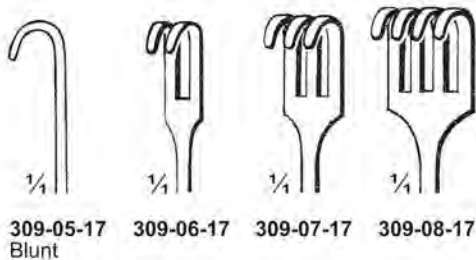

309-05-17 Blunt  
309-06-17  
309-07-17  
309-08-17

1/2  
Knapp  
309-01-17 To 309-08-17  
17 cm / 6 3/4"



1/4  
1/4  
Mannerfelt Modif.  
309-09-16  
16 cm / 6 1/4"



1/4  
1/4  
Mannerfelt Modif.  
309-10-16  
16 cm / 6 1/4"



1/4  
1/4  
Mannerfelt Modif.  
309-11-15  
15 cm / 6"  
Flexible shaft  
Sharp

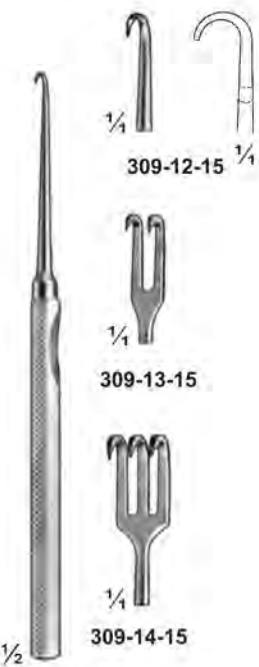

1/4  
1/4  
1/4  
Mannerfelt Modif.  
309-12-15 To 309-17-15  
15 cm / 6"  
Small cur



1/4  
1/4  
1/4  
Mannerfelt Modif.  
309-15-15 To 309-23-15  
15 cm / 6"  
Large cur

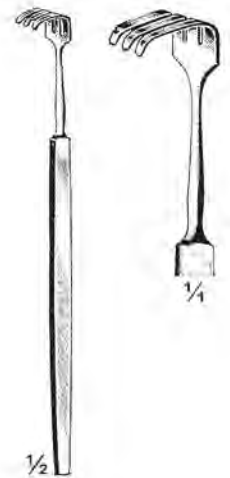

1/4  
1/4  
1/4  
Paul  
309-24-12  
12 cm / 4 3/4"



310-01-16  
16 cm / 6 1/4"



310-02-16  
16 cm / 6 1/4"



Mannerfelt Modif.  
310-03-15 & 310-04-15  
15 cm / 6"

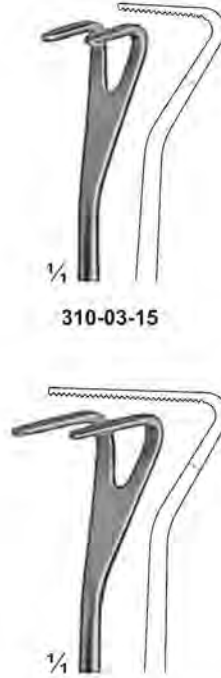

310-04-15



Rollet  
310-05-13 To 310-07-13



310-05-13  
13 cm / 5 1/8"  
Sharp



310-06-13  
13 cm / 5 1/8"  
Sharp



310-07-13  
13.5 cm / 5 1/4"  
Blunt



310-08-16  
16 cm / 6 1/4"



Machatt  
310-09-16 & 310-10-16  
16 cm / 6 1/4"



310-09-16  
Sharp



310-10-16  
Blunt



Knapp  
310-11-16 & 310-12-16  
16 cm / 6 1/4"



310-11-16  
310-13-16  
Sharp



310-12-16  
310-14-16  
Blunt



Knapp  
310-13-16 & 310-14-16  
16 cm / 6 1/4"



Knapp  
310-15-16 & 310-16-16  
16 cm / 6 1/4"  
Flexible shaft



310-15-16  
Sharp



310-16-16  
Blunt

**Wundhaken ; Separadores  
Retractors ; Divaricatori  
Ecarteurs ; Afastadores**

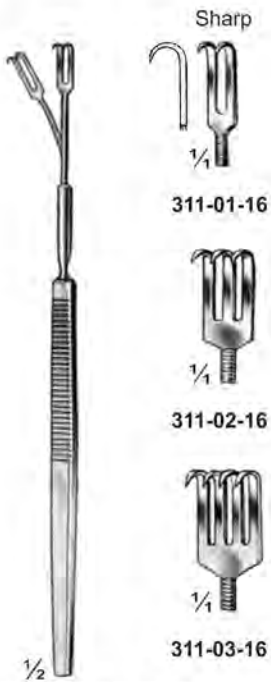

**311-01-16 To 311-06-16**  
16 cm / 6 1/4"  
Flexible shaft



**Volkmann**  
311-07-12 To 311-22-15

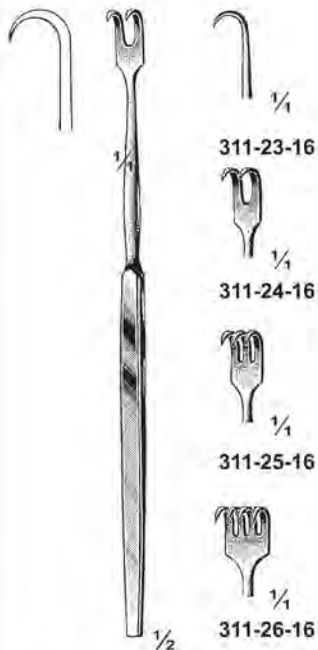

**311-23-16 To 311-26-16**  
16 cm / 6 1/4"  
Sharp

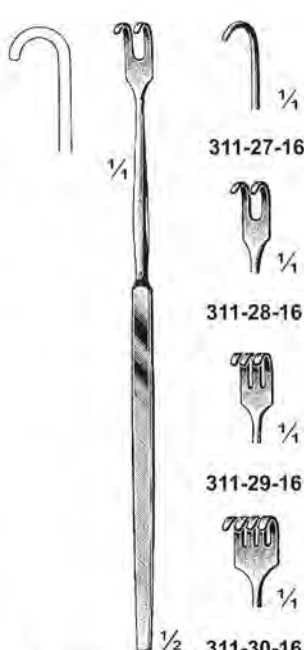
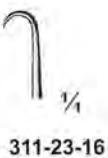

**311-27-16 To 311-30-16**  
16 cm / 6 1/4"  
Blunt

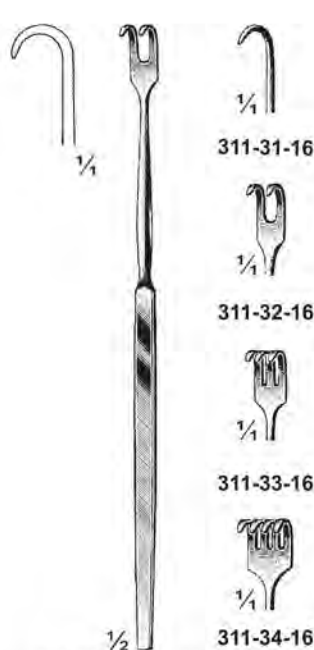

**311-31-16 To 311-34-16**  
16 cm / 6 1/4"  
Semi sharp

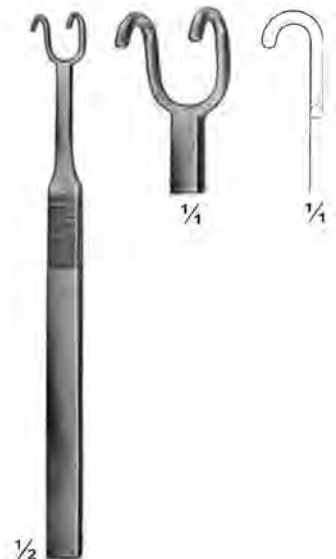

**Fomon**  
**311-35-14**  
14.5 cm / 5 3/4"



**Wundhaken ; Separadores  
Retractors ; Divaricatori  
Ecarteurs ; Afastadores**

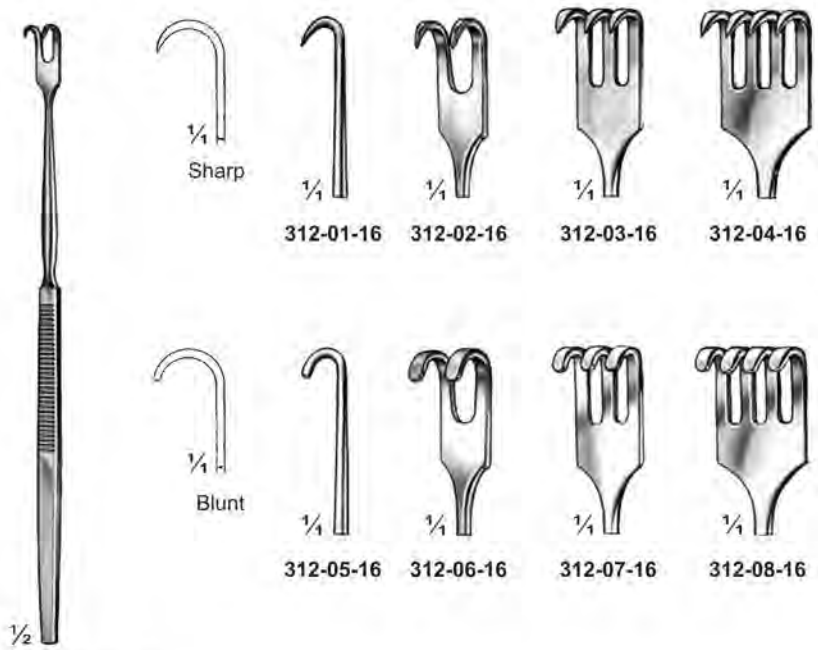

**312-01-16 To 312-08-16**  
16 cm / 6 1/4"

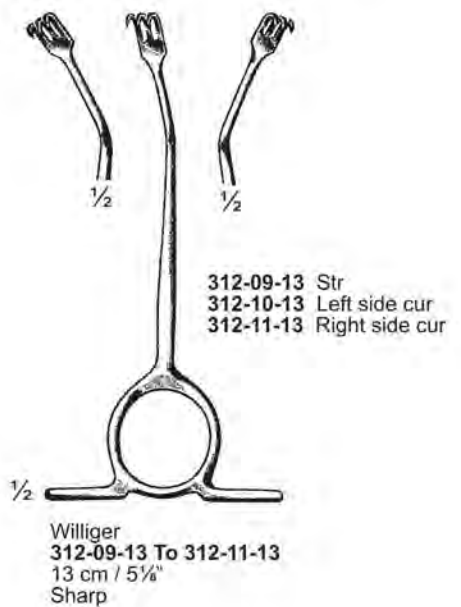

**312-09-13 Str**  
**312-10-13 Left side cur**  
**312-11-13 Right side cur**  
**Williger**  
**312-09-13 To 312-11-13**  
13 cm / 5 1/8"  
Sharp

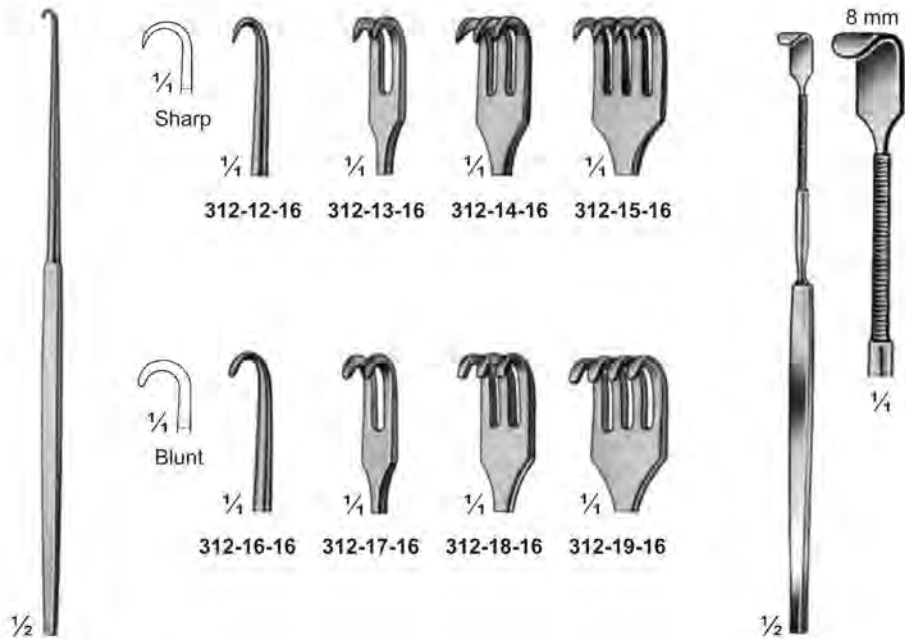

**312-12-16 To 312-19-16**  
16.5 cm / 6 1/2"  
Small cur

**312-20-16**  
16 cm / 6 1/4"  
Flexible shaft

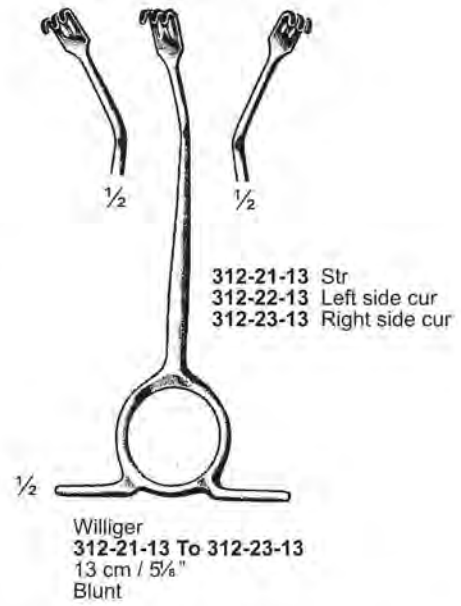

**312-21-13 Str**  
**312-22-13 Left side cur**  
**312-23-13 Right side cur**  
**Williger**  
**312-21-13 To 312-23-13**  
13 cm / 5 1/8"  
Blunt



**Wundhaken ; Separadores  
Retractors ; Divaricatori  
Ecarteurs ; Afastadores**



Meyering  
313-01-18 To 313-06-18  
18 cm / 7"



313-01-18  
18 X 7 mm



313-02-18  
16 X 5 mm



313-03-18  
7 X 4 mm



313-04-18  
5 X 10 mm



313-05-18  
11 X 4 mm



313-06-18  
6 X 4 mm



Klapp  
313-07-17  
17 cm / 6 3/4"



15 X 9 mm



Venenhaken Brom  
313-08-19 & 313-09-19  
19 cm / 7 1/2"



313-08-19



313-09-19



Klapp  
313-10-18  
18 cm / 7"



15 X 11 mm

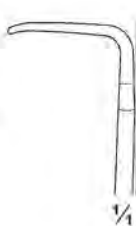

1/4



1/2



1/4

313-11-18  
12 X 6 mm



1/4

313-12-18  
12 X 11 mm

Klapp  
313-11-18 & 313-12-18  
18 cm / 7"



313-13-18  
6 X 15 mm



313-14-18  
6 X 15 mm  
Toothed



1/2

Strandell-Stille  
313-13-18 & 313-14-18  
18 cm / 7"

**Wundhaken ; Separadores  
Retractors ; Divaricatori  
Ecarteurs ; Afastadores**



1/2  
Volkmann  
314-01-20 To 314-10-20  
20 cm / 8"

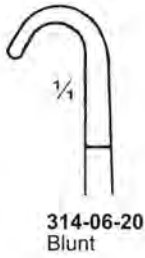
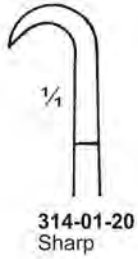

Kocher  
314-11-20  
20 cm / 8"  
Semi-Sharp



Kocher  
314-12-22  
22 cm / 8 3/4"  
Sharp



Kocher  
314-13-22  
22 cm / 8 3/4"  
Blunt



Volkmann  
314-14-22  
22 cm / 8 3/4"  
Sharp



Volkmann  
314-15-22  
22 cm / 8 3/4"  
Blunt



**Wundhaken ; Separadores  
Retractors ; Divaricatori  
Ecarteurs ; Afastadores**

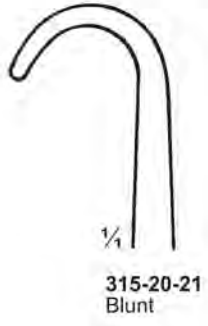
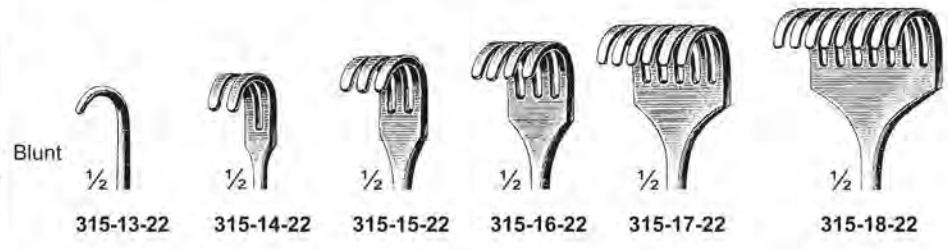
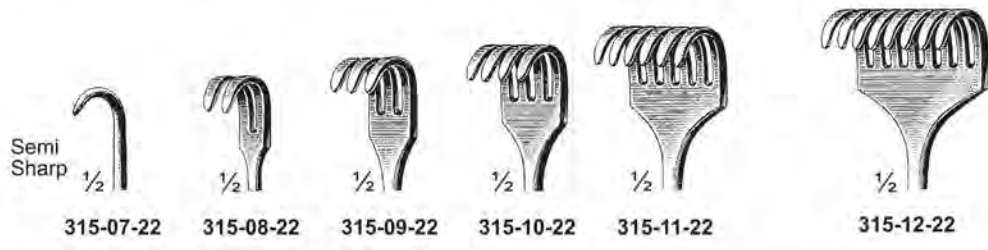
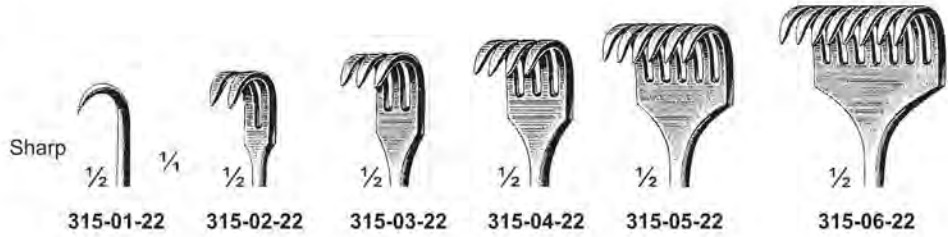

Volkman  
315-01-22 To 315-18-22  
22 cm / 8 3/4"

Volkman  
315-19-21 & 315-20-21  
21 cm / 8 1/4"

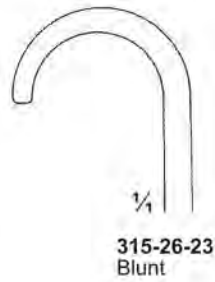
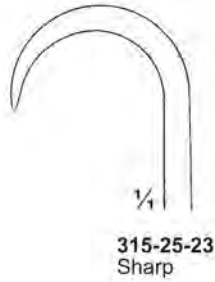
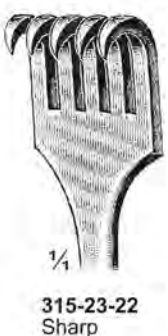

Volkman  
315-21-22 To 315-24-22  
22 cm / 8 3/4"

Volkman  
315-25-23 & 315-26-23  
23 cm / 9"

**Wundhaken ; Separadores  
Retractors ; Divaricatori  
Ecarteurs ; Afastadores**

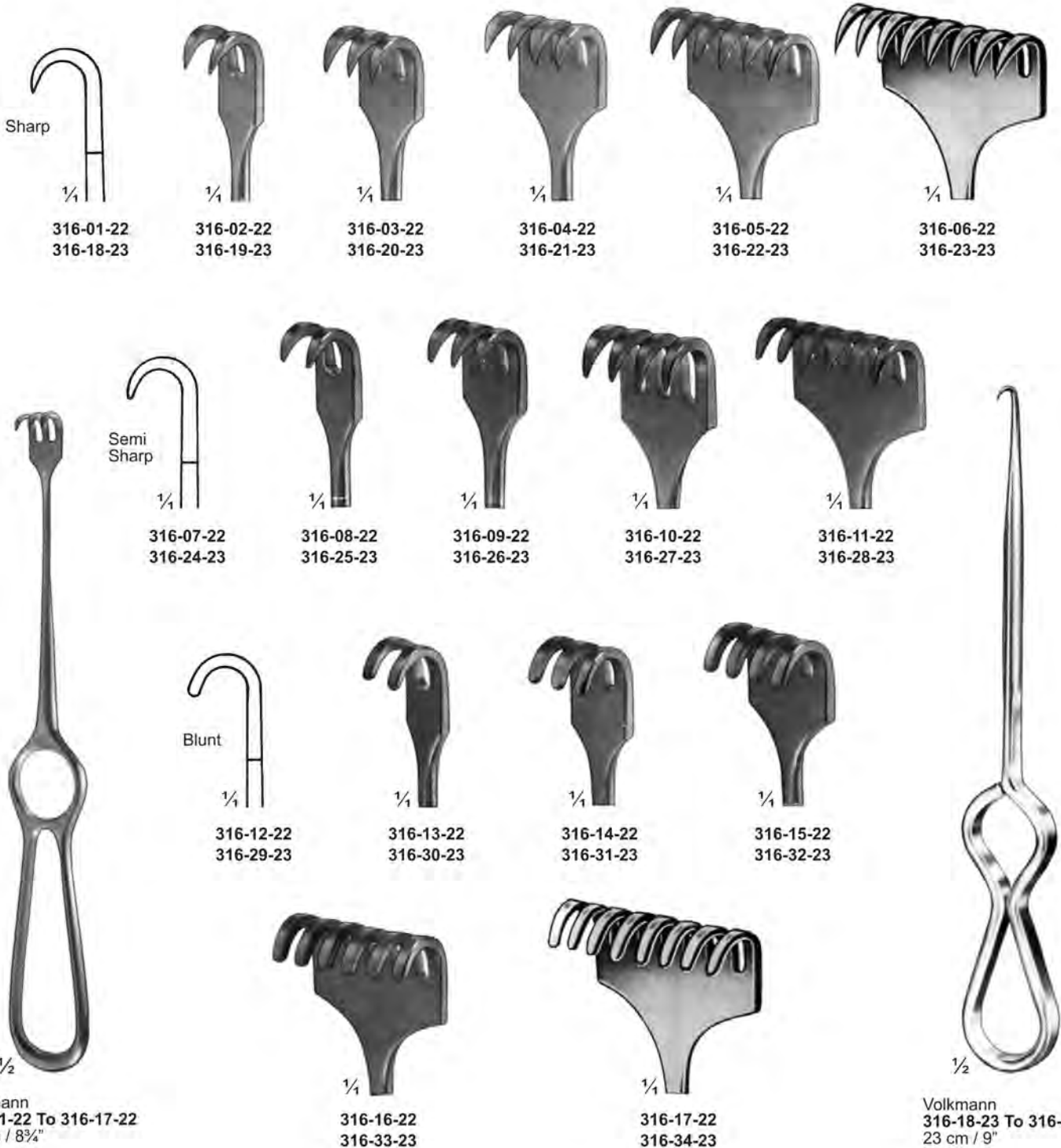

Sharp

1/4

316-01-22  
316-18-23

1/4

316-02-22  
316-19-23

1/4

316-03-22  
316-20-23

1/4

316-04-22  
316-21-23

1/4

316-05-22  
316-22-23

1/4

316-06-22  
316-23-23

Semi Sharp

1/4

316-07-22  
316-24-23

1/4

316-08-22  
316-25-23

1/4

316-09-22  
316-26-23

1/4

316-10-22  
316-27-23

1/4

316-11-22  
316-28-23

Blunt

1/4

316-12-22  
316-29-23

1/4

316-13-22  
316-30-23

1/4

316-14-22  
316-31-23

1/4

316-15-22  
316-32-23

1/2

Volkman  
316-01-22 To 316-17-22  
22 cm / 8 3/4"

1/4

316-16-22  
316-33-23

1/4

316-17-22  
316-34-23

1/2

Volkman  
316-18-23 To 316-34-23  
23 cm / 9"

**Wundhaken ; Separadores  
Retractors ; Divaricatori  
Ecarteurs ; Afastadores**



Korte  
317-01-26 & 317-02-26  
26 cm / 10 1/4"



317-01-26  
317-03-24  
26 X 40 mm  
Blunt



317-02-26  
317-04-24  
26 X 40 mm  
Sharp



Korte  
317-03-24 & 317-04-24  
24 cm / 9 1/2"  
Blunt



Korte  
317-05-23  
23 cm / 9"  
Blunt



Volkmann  
317-06-22 To 317-13-22  
22 cm / 8 3/4"

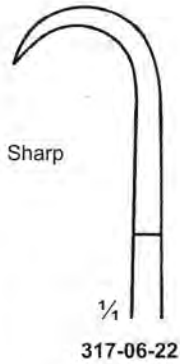

Sharp

317-06-22

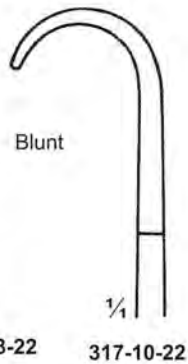

Blunt

317-10-22



317-07-22



317-11-22



317-08-22



317-12-22



317-09-22



317-13-22

**Wundhaken ; Separadores  
Retractors ; Divaricatori  
Ecarteurs ; Afastadores**



1/4  
318-01-22  
318-09-23  
Sharp



1/4  
318-02-22  
318-10-23  
Sharp



1/4



1/4  
318-03-22  
318-11-23  
Sharp



1/4  
318-04-22  
318-12-23  
Sharp



1/4



1/2

Kocher  
318-01-22 To 318-08-22  
22 cm / 8 3/4"

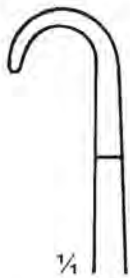

1/4  
318-05-22  
318-13-23  
Blunt



1/4  
318-06-22  
318-14-23  
Blunt



1/4  
318-07-22  
318-15-23  
Blunt



1/4  
318-08-22  
318-16-23  
Blunt



1/2

Kocher  
318-09-23 To 318-16-23  
23 cm / 9"

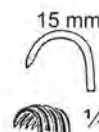

15 mm  
1/4



1/2

Lampert  
318-21-19  
19.5 cm / 7 3/4"  
318-22-22  
22 cm / 8 3/4"



1/2

318-19-23 Sharp  
318-20-23 Blunt  
23 cm / 9"



25 mm  
1/4



1/2

Lampert  
318-23-24  
24 cm / 9 1/2"  
318-24-27  
27 cm / 10 1/2"

**Wundhaken ; Separadores  
Retractors ; Divaricatori  
Ecarteurs ; Afastadores**

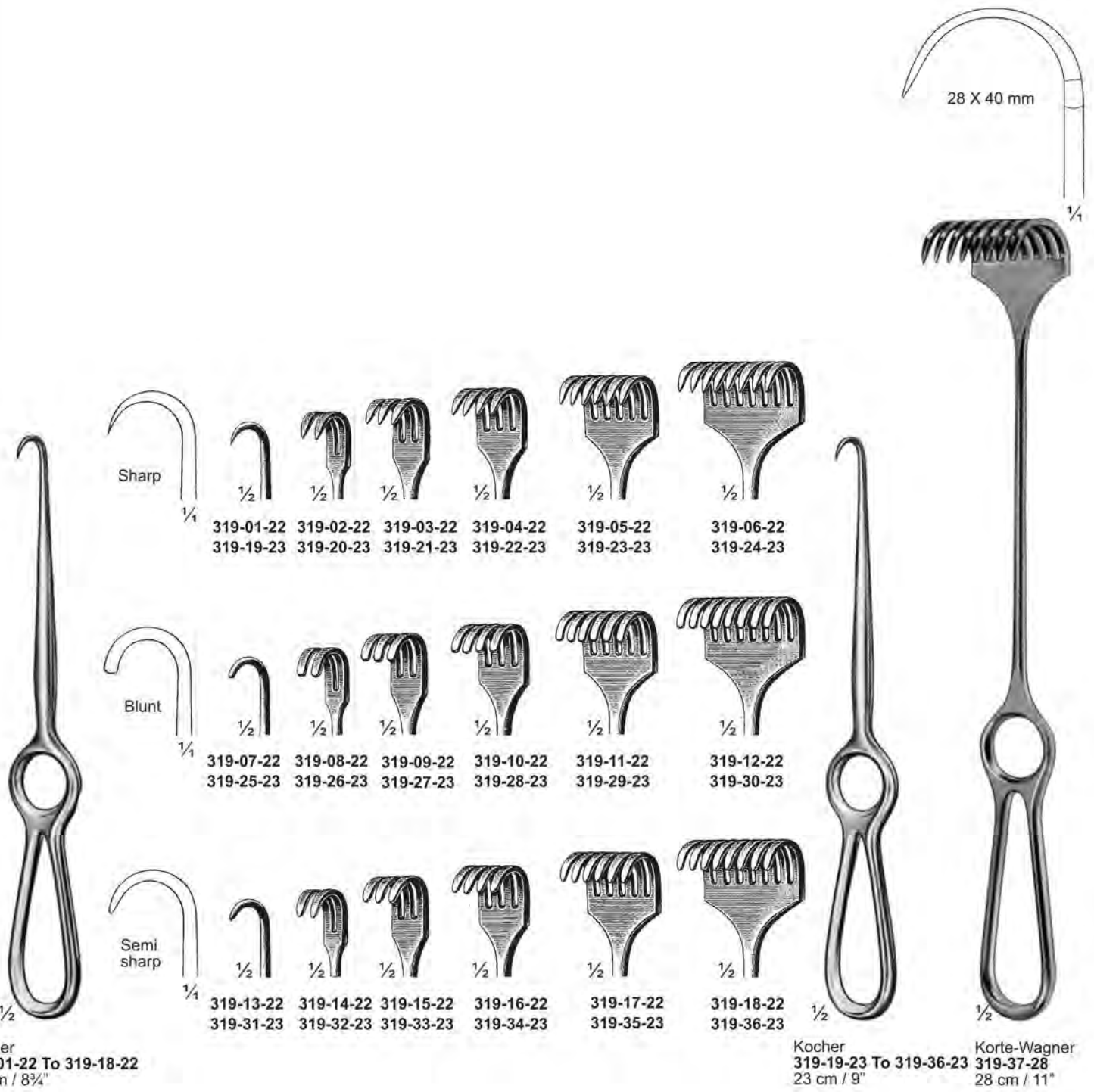

**Sharp**  $\frac{1}{4}$

$\frac{1}{2}$	$\frac{1}{2}$	$\frac{1}{2}$	$\frac{1}{2}$	$\frac{1}{2}$	$\frac{1}{2}$	$\frac{1}{2}$
319-01-22	319-02-22	319-03-22	319-04-22	319-05-22	319-06-22	
319-19-23	319-20-23	319-21-23	319-22-23	319-23-23	319-24-23	

**Blunt**  $\frac{1}{4}$

$\frac{1}{2}$	$\frac{1}{2}$	$\frac{1}{2}$	$\frac{1}{2}$	$\frac{1}{2}$	$\frac{1}{2}$	$\frac{1}{2}$
319-07-22	319-08-22	319-09-22	319-10-22	319-11-22	319-12-22	
319-25-23	319-26-23	319-27-23	319-28-23	319-29-23	319-30-23	

**Semi sharp**  $\frac{1}{4}$

$\frac{1}{2}$	$\frac{1}{2}$	$\frac{1}{2}$	$\frac{1}{2}$	$\frac{1}{2}$	$\frac{1}{2}$	$\frac{1}{2}$
319-13-22	319-14-22	319-15-22	319-16-22	319-17-22	319-18-22	
319-31-23	319-32-23	319-33-23	319-34-23	319-35-23	319-36-23	

**28 X 40 mm**  $\frac{1}{4}$

**22 cm / 8 $\frac{3}{4}$ "**

**23 cm / 9"**

**28 cm / 11"**



**Wundhaken ; Separadores  
Retractors ; Divaricatori  
Ecarteurs ; Afastadores**

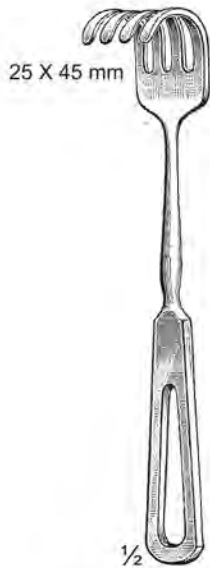

Mikulicz  
320-01-23 23 cm / 9"  
320-02-26 26 cm / 10 1/4"

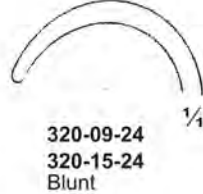
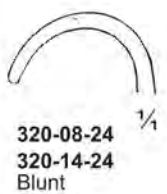
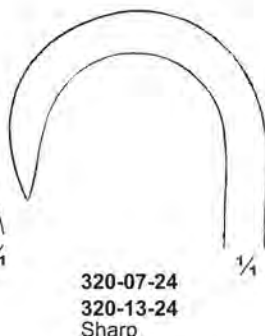
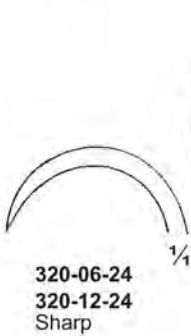
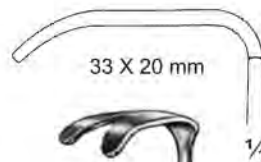

Kocher  
320-04-24 To 320-09-24  
24 cm / 9 1/2"

Ollier  
320-17-25 25 mm  
320-18-35 35 mm  
320-19-45 45 mm  
320-20-60 60 mm  
25 cm / 10"



**Wundhaken ; Separadores  
Retractors ; Divaricatori  
Ecarteurs ; Afastadores**

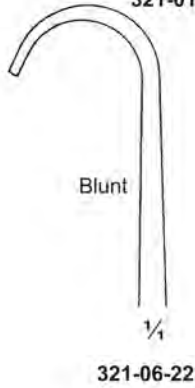
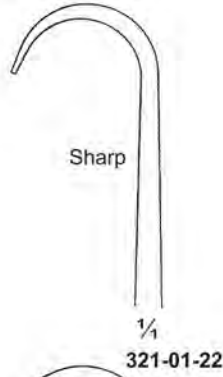

321-01-22 To 321-10-22  
22 cm / 8 3/4"

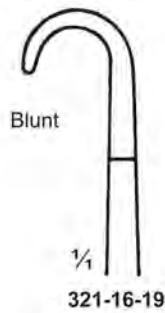
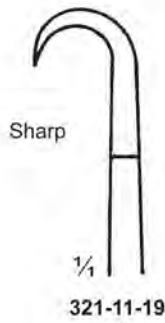

Murphy  
321-11-19 To 321-20-19  
19.5 cm / 7 3/4"

**Wundhaken ; Separadores  
Retractors ; Divaricatori  
Ecarteurs ; Afastadores**



322-01-23  
322-05-24  
322-09-23  
40 X 40 mm



322-02-23  
322-06-24  
322-10-23  
40 X 50 mm

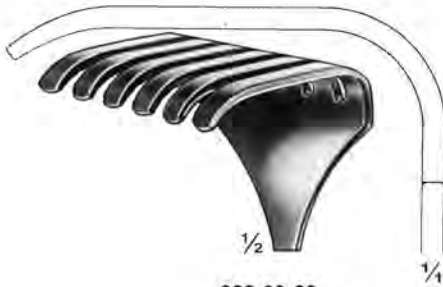

322-03-23  
322-07-24  
322-11-23  
50 X 60 mm

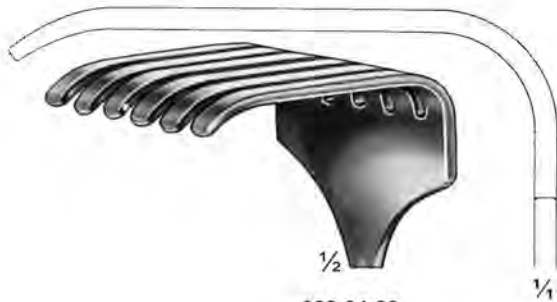

322-04-23  
322-08-24  
322-12-23  
70 X 70 mm



Ollier  
322-13-24  
24 cm / 9 1/2"

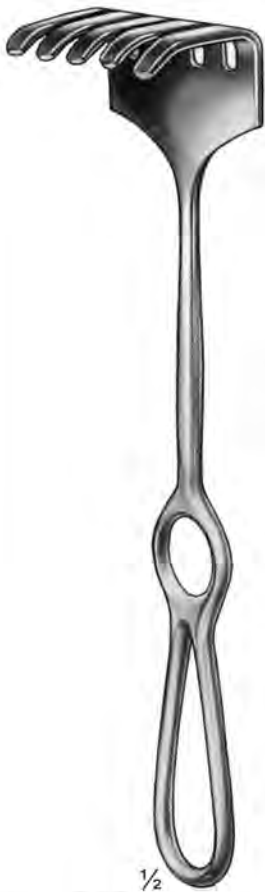

Israel  
322-01-23 To 322-04-23  
23 cm / 9"



Israel  
322-05-24 To 322-08-24  
24 cm / 9 1/2"

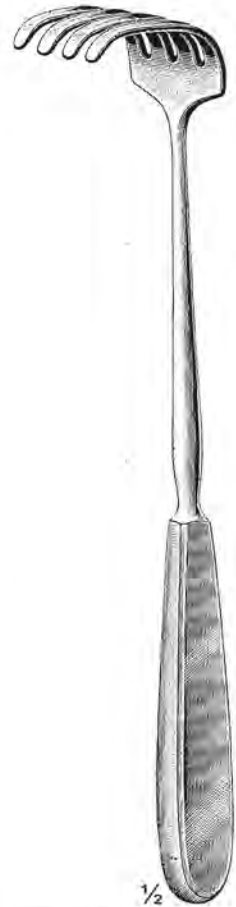

Israel  
322-09-23 To 322-12-23  
23 cm / 9"



**Wundhaken ; Separadores  
Retractors ; Divaricatori  
Ecarteurs ; Afastadores**



**323-01-27**  
38 X 58 mm



**323-02-27**  
50 X 58 mm



**323-03-27**  
68 X 58 mm



**323-04-27**  
75 X 58 mm



**323-01-27 To 323-04-27**  
27 cm / 10½"

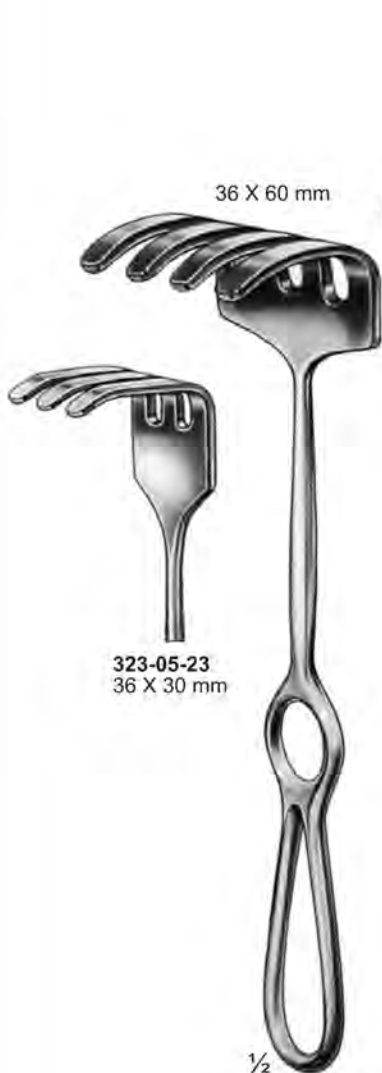

**323-05-23**  
36 X 30 mm

Ollier  
**323-05-23** 36 X 30 mm  
**323-06-23** 36 X 60 mm  
23 cm / 9"

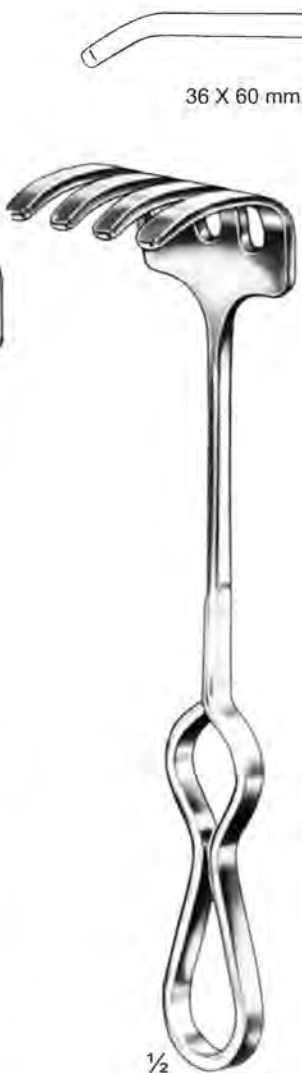

Ollier  
**323-07-23** 36 X 30 mm  
**323-08-23** 36 X 60 mm  
23 cm / 9"



Ollier  
**323-09-22 To 323-12-22**  
22 cm / 8½"



Ollier-Collin  
**323-13-24 To 323-16-24**  
24 cm / 9½"

**Wundhaken ; Separadores  
Retractors ; Divaricatori  
Ecarteurs ; Afastadores**

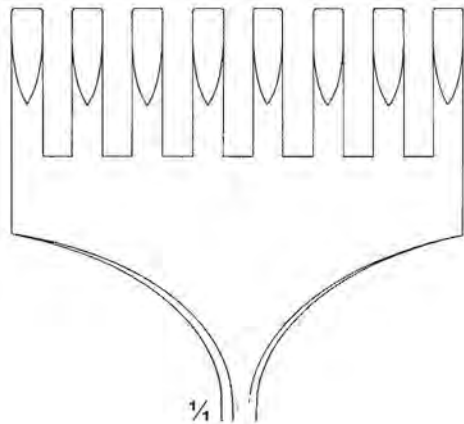

1/4  
**324-01-25**  
**324-02-25**  
26 X 60 mm

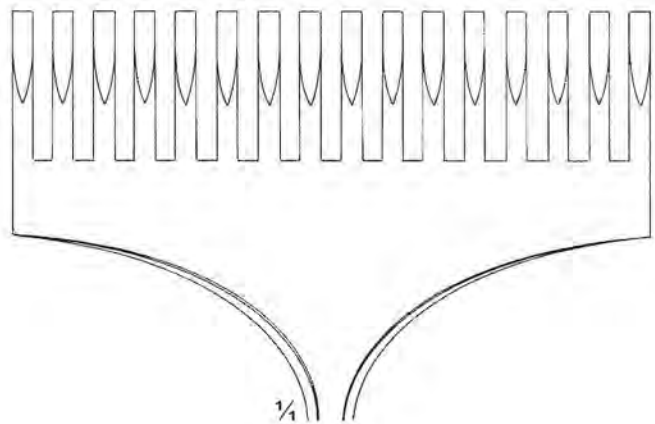

1/4  
**324-03-24**  
**324-04-24**  
25 X 85 mm



26 X 60 mm

1/2

**324-01-25**  
25 cm / 10"  
Sharp



26 X 60 mm

1/2

**324-02-25**  
25 cm / 10"  
Sharp



26 X 85 mm

1/2

**324-03-24**  
24.5 cm / 9 3/4"  
Sharp



25 X 85 mm

1/2

**324-04-24**  
24.5 cm / 9 3/4"  
Sharp



**Wundhaken ; Separadores  
Retractors ; Divaricatori  
Ecarteurs ; Afastadores**



1/2

Billroth  
325-01-25 To 325-03-25  
25 cm / 10"



1/4

1/2

325-01-25  
40 X 35 mm



1/4

1/2

325-02-25  
35 X 43 mm



1/4

1/2

325-03-25  
50 X 45 mm



50 X 80 mm

1/4

1/2

325-04-26  
26 cm / 10 1/4"



1/4

1/2

325-05-27  
27 cm / 10 1/2"

**Wundhaken ; Separadores  
Retractors ; Divaricatori  
Ecarteurs ; Afastadores**



1/4  
326-01-16  
326-05-16  
326-09-16  
326-13-17  
10 X 6 mm



1/4  
326-02-16  
326-06-16  
326-10-16  
326-14-17  
17 X 5 mm



1/3  
Howell  
326-19-21 40 X 10 mm  
326-20-21 40 X 15 mm  
326-21-21 40 X 20 mm  
326-22-21 40 X 25 mm  
21 cm / 8 1/4"



1/4  
326-03-16  
326-07-16  
326-11-16  
326-15-17  
20 X 6 mm



1/4  
326-04-16  
326-08-16  
326-12-16  
326-16-17  
22 X 8 mm

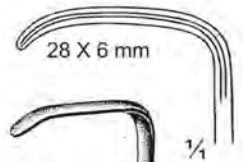

28 X 6 mm



1/2  
Mini-Langenbeck  
326-01-16 To 326-04-16  
16 cm / 6 1/4"



1/2  
Langenbeck-  
Mannerfelt Modif.  
326-05-16 To 326-08-16  
16 cm / 6 1/4"



1/2  
Langenbeck-Green  
326-09-16 To 326-12-16  
16 cm / 6 1/4"



1/2  
Langenbeck-Green  
326-13-17 To 326-16-17  
17 cm / 6 3/4"



1/2  
Lahey  
326-17-18  
18 cm / 7"



1/2  
Lahey  
326-18-18  
19 cm / 7 1/2"

**Wundhaken ; Separadores  
Retractors ; Divaricatori  
Ecarteurs ; Afastadores**

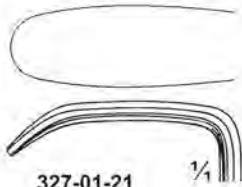

327-01-21  
327-06-23  
327-11-22  
30 X 11 mm

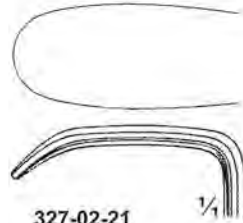

327-02-21  
327-07-23  
327-12-22  
30 X 14 mm

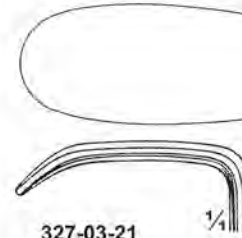

327-03-21  
327-08-23  
327-13-22  
30 X 16 mm

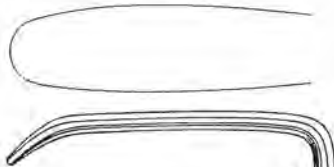

327-04-21  
327-09-23  
327-14-22  
40 X 11 mm

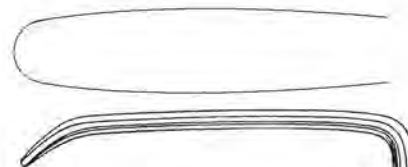

327-05-21  
327-10-23  
327-15-22  
50 X 11 mm



Langenbeck  
327-01-21 To 327-05-21  
21 cm / 8 1/4"



Langenbeck  
327-06-23 To 327-10-23  
23 cm / 9"



Langenbeck  
327-11-22 To 327-15-22  
22 cm / 8 1/2"



**Wundhaken ; Separadores  
Retractors ; Divaricatori  
Ecarteurs ; Afastadores**

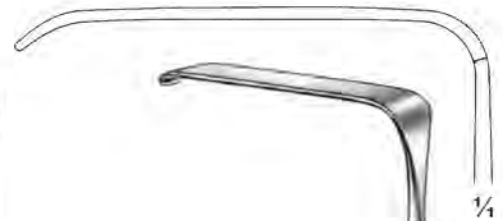

Lagenbeck  
328-04-22 To 328-07-22  
22 cm / 8 $\frac{3}{4}$ "



Lagenbeck  
328-08-22 To 328-11-22  
22 cm / 8 $\frac{3}{4}$ "

Sauerbruch  
328-01-23 To 328-03-23  
23 cm / 9"



**Wundhaken ; Separadores  
Retractors ; Divaricatori  
Ecarteurs ; Afastadores**

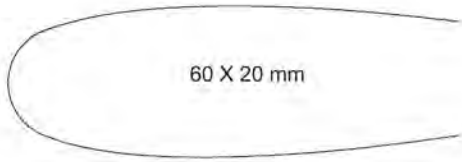

60 X 20 mm

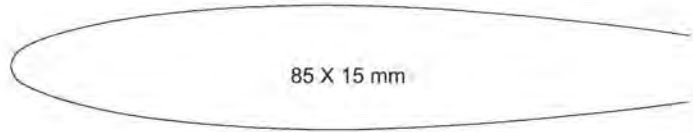

85 X 15 mm



1/4



1/4



1/2

Langenbeck  
329-01-21  
21 cm / 8 1/4"

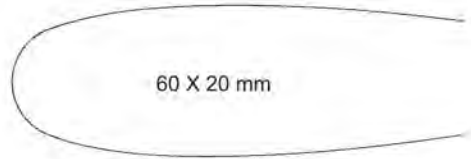

60 X 20 mm



1/4

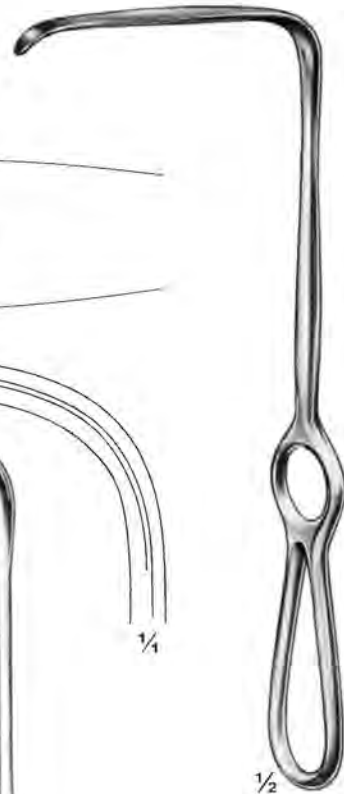

1/2

Langenbeck  
329-03-21  
21.5 cm / 8 1/2"



85 X 15 mm

1/2

Langenbeck  
329-04-23  
23 cm / 9"

1/2

Langenbeck  
329-02-23  
23 cm / 9"

**Wundhaken ; Separadores  
Retractors ; Divaricatori  
Ecarteurs ; Afastadores**



Kocher  
330-01-23 To 330-10-23  
23 cm / 9"

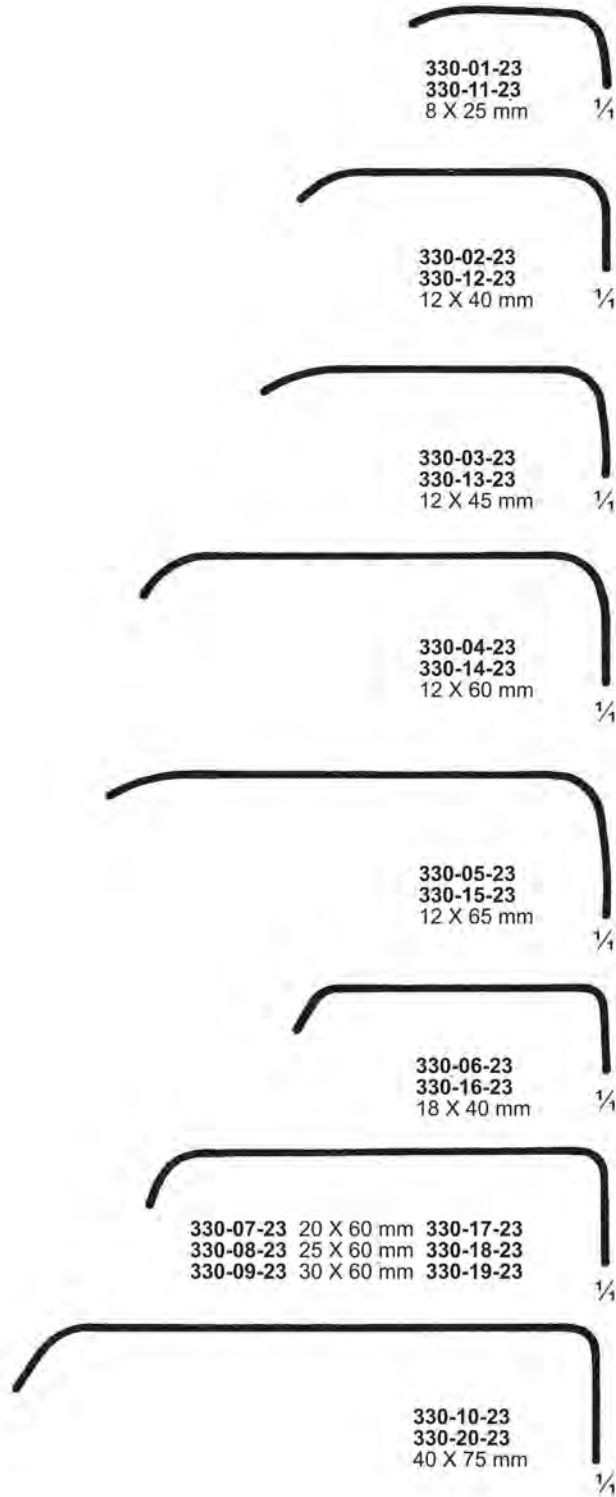

Kocher  
330-11-23 To 330-20-23  
23 cm / 9"

**Wundhaken ; Separadores  
Retractors ; Divaricatori  
Ecarteurs ; Afastadores**

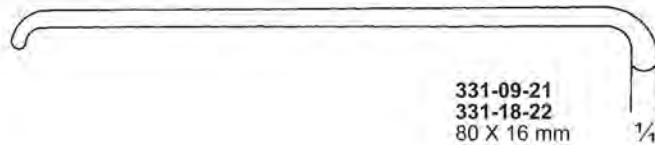
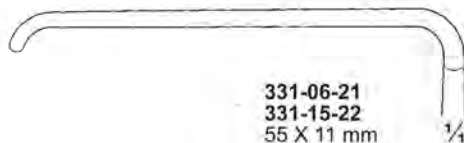
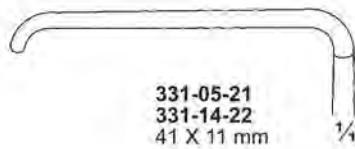
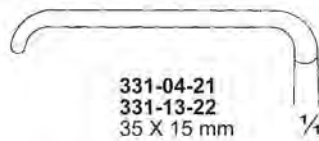
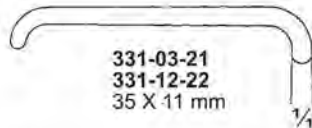
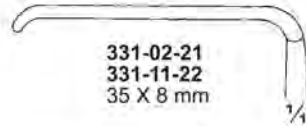
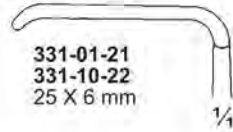

Kocher-Lagenbeck  
331-01-21 To 331-09-21  
21.5 cm / 8 1/2"



Kocher-Lagenbeck  
331-10-22 To 331-18-22  
22 cm / 8 3/4"

**Wundhaken ; Separadores  
Retractors ; Divaricatori  
Ecarteurs ; Afastadores**

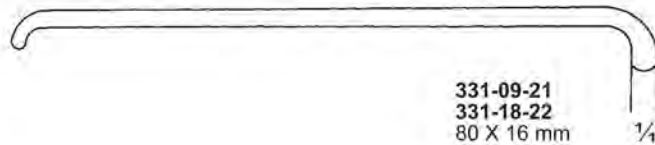
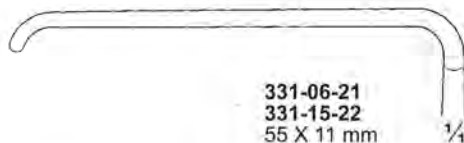
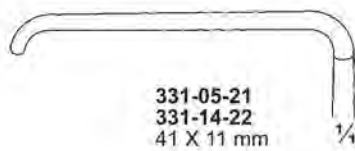
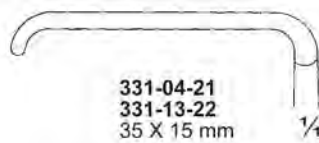
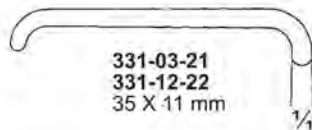
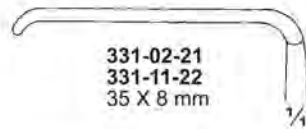
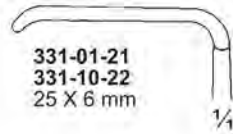

Kocher-Lagenbeck  
331-01-21 To 331-09-21  
21.5 cm / 8 1/2"



Kocher-Lagenbeck  
331-10-22 To 331-18-22  
22 cm / 8 3/4"

**Wundhaken ; Separadores  
Retractors ; Divaricatori  
Ecarteurs ; Afastadores**

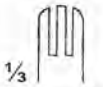

333-01-25  
32 X 20 mm



333-02-25  
48 X 24 mm



Semb  
333-01-25 & 333-02-25  
25 cm / 10"

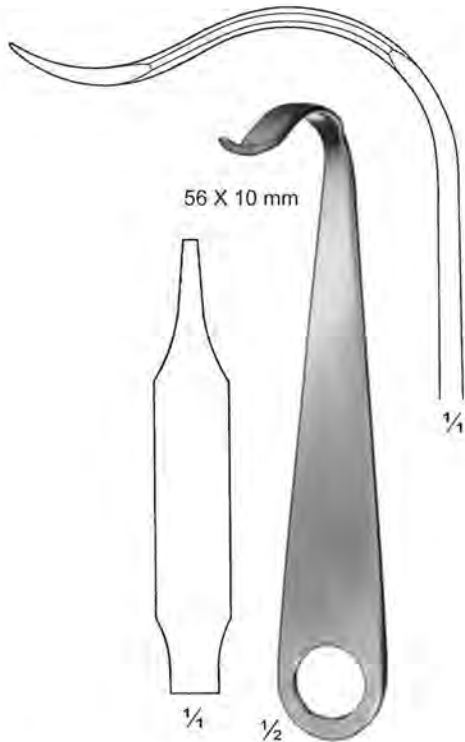

56 X 10 mm

333-03-17  
17 cm / 6 3/4"

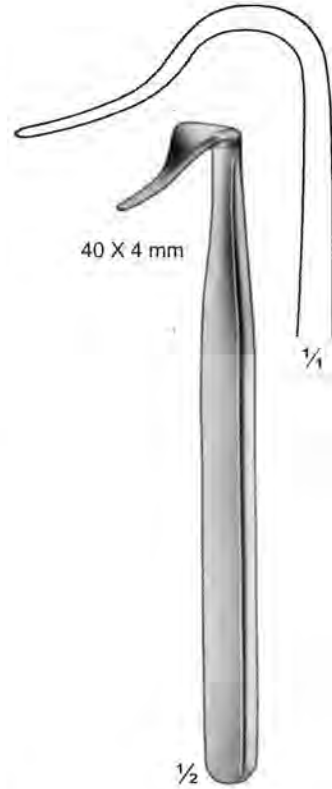

40 X 4 mm

Blount  
333-04-18  
18 cm / 7"

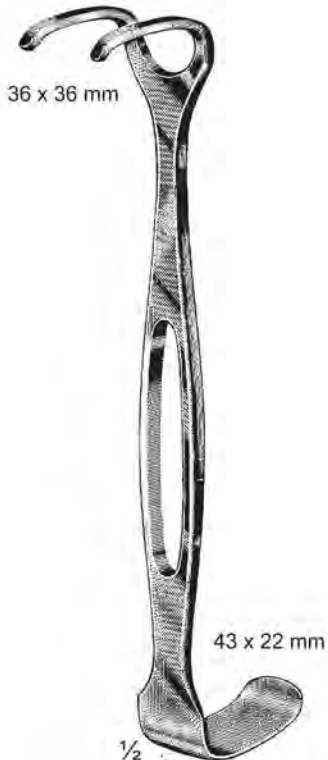

36 x 36 mm

43 x 22 mm

Czerny  
333-05-19  
19 cm / 7 1/2"

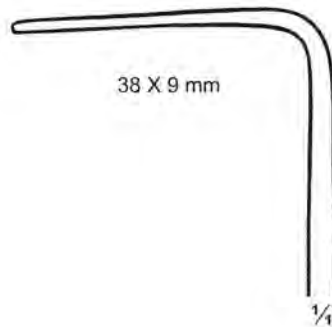

38 X 9 mm



333-06-21  
21.5 cm / 8 1/2"

- 333-07-24 26 X 6 mm
- 333-08-24 28 X 6 mm
- 333-09-24 28 X 10 mm
- 333-10-24 28 X 16 mm
- 333-11-24 32 X 14 mm
- 333-12-24 38 X 9 mm
- 333-13-24 38 X 12 mm
- 333-14-24 40 X 10 mm
- 333-15-24 40 X 15 mm
- 333-16-24 42 X 13 mm



Lahey  
333-07-24 To 337-16-24  
24 cm / 9 1/2"

**Wundhaken ; Separadores  
Retractors ; Divaricatori  
Ecarteurs ; Afastadores**

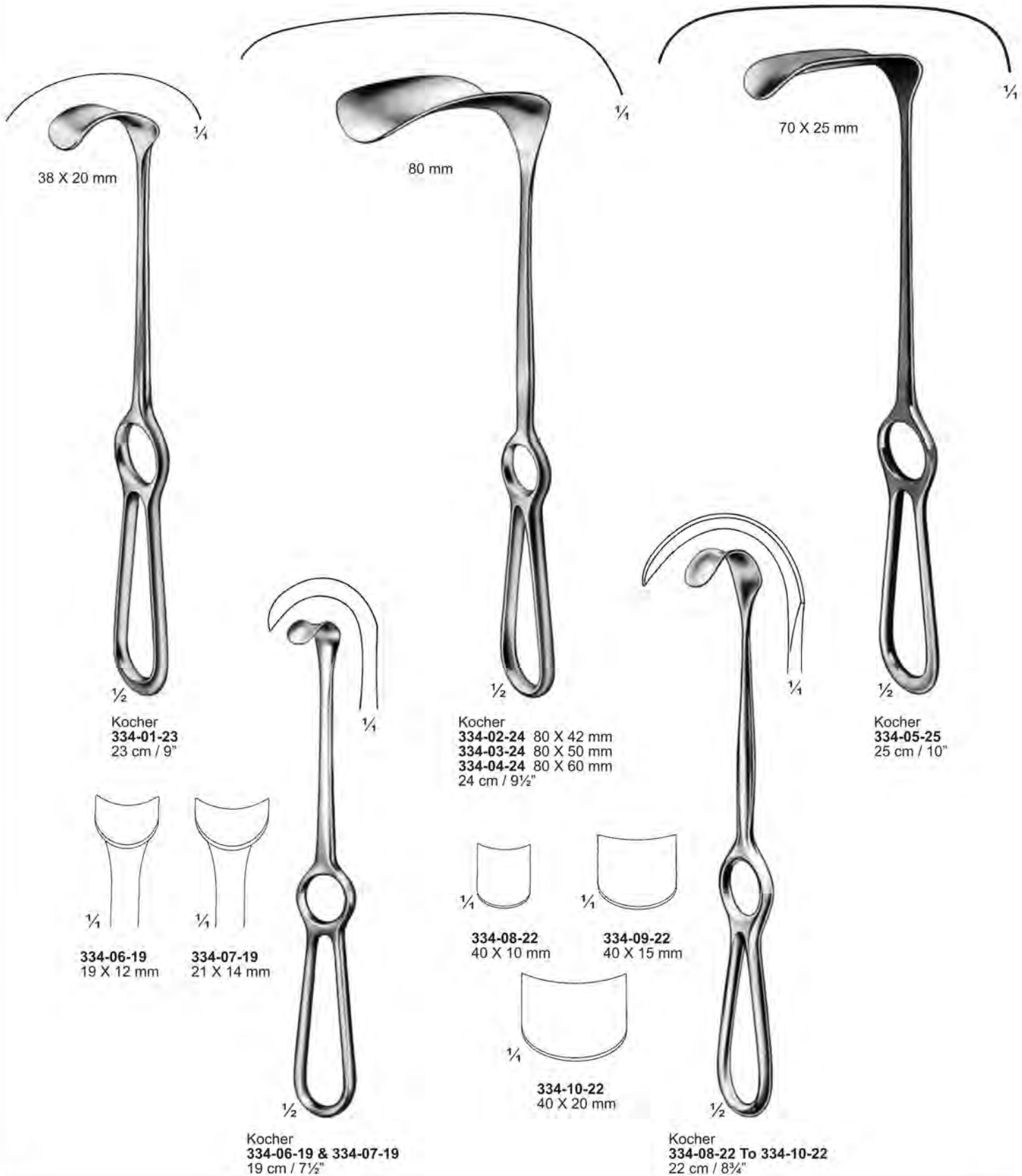

**Wundhaken ; Separadores  
Retractors ; Divaricatori  
Ecarteurs ; Afastadores**



$\frac{1}{2}$   
Simon  
335-01-28 & 335-02-28  
28 cm / 11"

$\frac{1}{2}$   
Simon  
335-03-27 & 335-04-27  
27.5 cm / 10 $\frac{3}{4}$ "

$\frac{1}{4}$   
335-01-28  
335-03-27  
115 X 22 mm

$\frac{1}{4}$   
335-02-28  
335-04-27  
115 X 26 mm  $\frac{1}{2}$

335-05-25  
25 cm / 10"

$\frac{1}{4}$   
335-05-25  
335-06-25  
105 X 27 mm

$\frac{1}{2}$   
335-06-25  
25 cm / 10"



**Wundhaken ; Separadores  
Retractors ; Divaricatori  
Ecarteurs ; Afastadores**



Hibbs  
336-01-24 & 336-02-24  
24 cm / 9½"

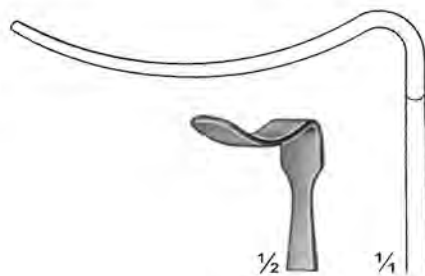
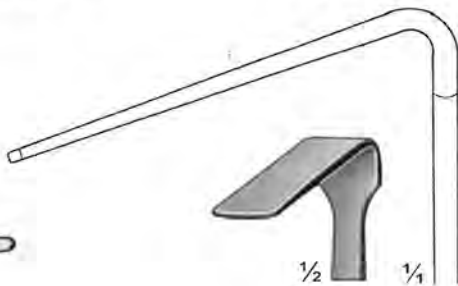
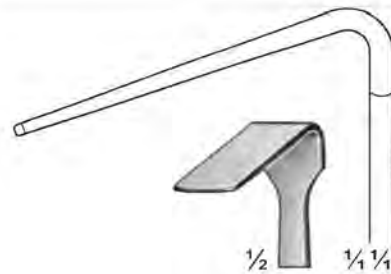
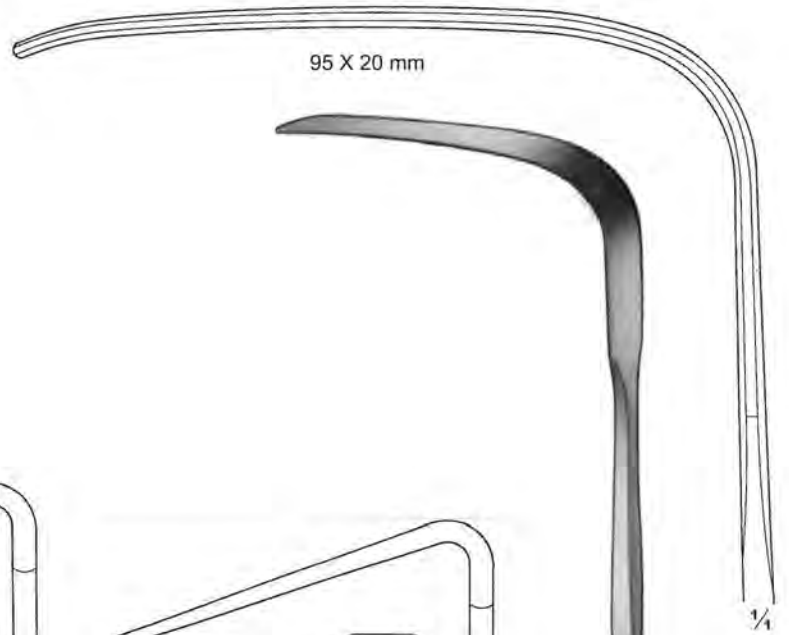
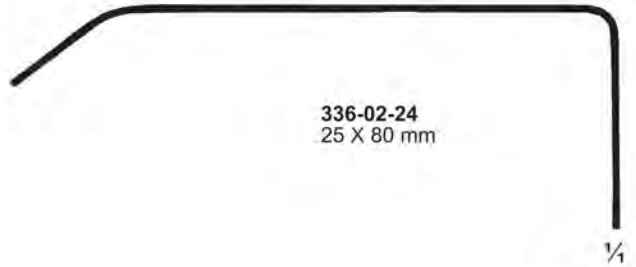
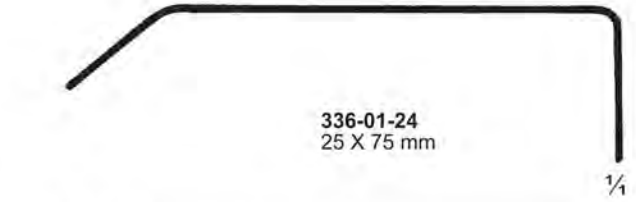
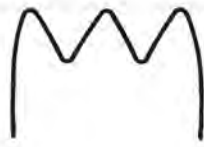

Modell Tubingen  
336-08-26  
26.5 cm / 10½"

**Wundhaken ; Separadores  
Retractors ; Divaricatori  
Ecarteurs ; Afastadores**



1/2  
**337-01-23**  
23 cm / 9"



Obwegeser  
**337-02-21 To 337-13-21**  
21.5 cm / 8 1/2"

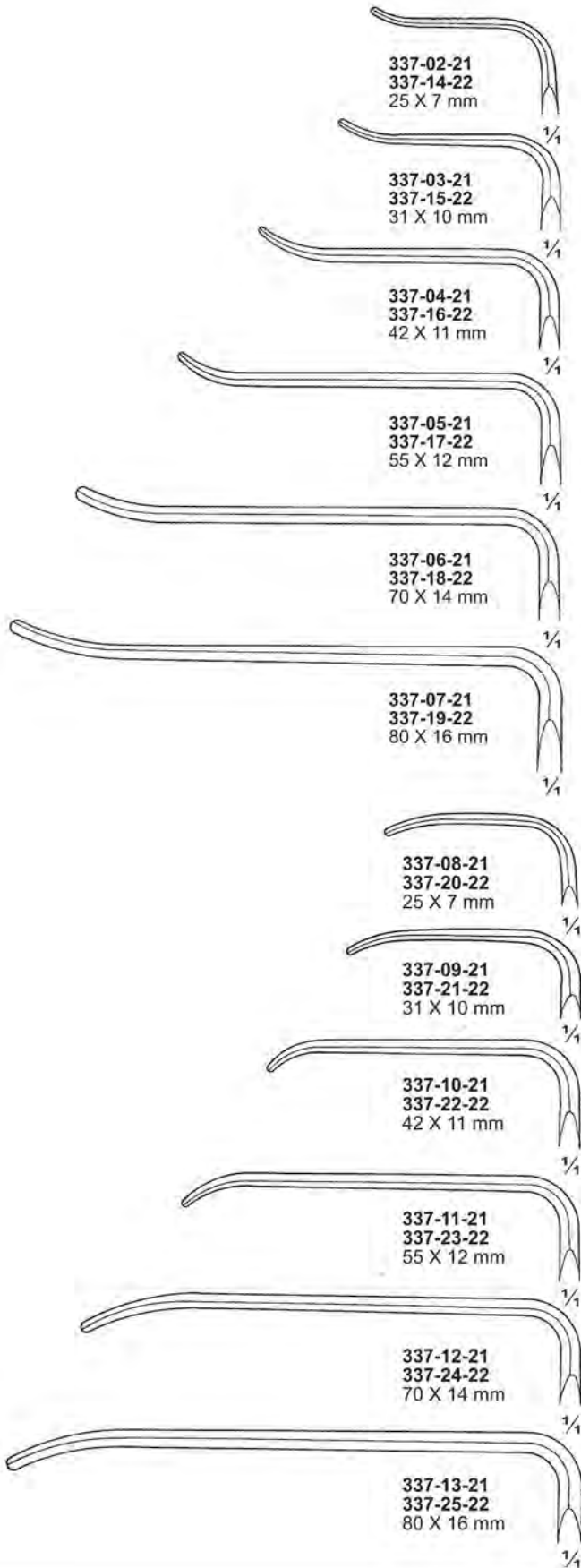

Lagenbeck  
**337-14-22 To 337-25-22**  
22 cm / 8 3/4"

**Wundhaken ; Separadores  
Retractors ; Divaricatori  
Ecarteurs ; Afastadores**



338-01-20 25 X 7 mm  
338-02-20 42 X 10 mm  
338-03-20 42 X 12 mm  
338-04-20 42 X 13 mm  
20 cm / 8"



Rasmus  
338-05-20 55 X 12 mm  
338-06-20 60 X 12 mm  
338-07-20 70 X 14 mm  
338-08-20 80 X 16 mm  
20 cm / 8"



338-09-17  
17 cm / 6 3/4"



338-10-17  
17 cm / 6 3/4"



338-16-27  
82 X 28 mm



Rowe  
338-11-20 20 cm / 8"  
338-12-23 23 cm / 9"



Rayne  
338-13-23  
23 cm / 9"



338-15-27  
73 X 28 mm

1/2



338-14-27  
45 X 25 mm

1/2

1/2

Heaney  
338-14-27 To 338-16-27  
27 cm / 10 1/2"

**Wundhaken ; Separadores  
Retractors ; Divaricatori  
Ecarteurs ; Afastadores**

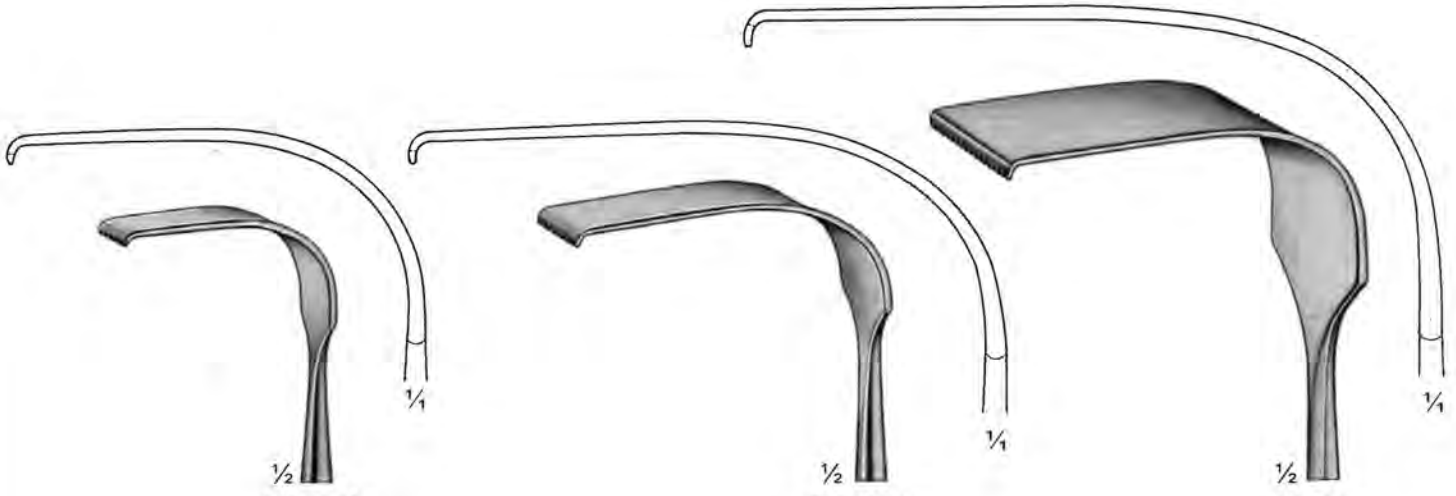

$\frac{1}{2}$   
**339-01-21**  
21 cm / 8 $\frac{1}{4}$ "  
52 X 16 mm

$\frac{1}{2}$   
**339-02-23**  
23 cm / 9"  
76 X 25 mm

$\frac{1}{2}$   
**339-03-25**  
25 cm / 10"  
89 X 50 mm



$\frac{1}{2}$   
Meyerding  
**339-01-21 To 339-03-25**



$\frac{1}{2}$   
**339-04-28 To 339-06-28**  
28 cm / 11"



$\frac{1}{4}$

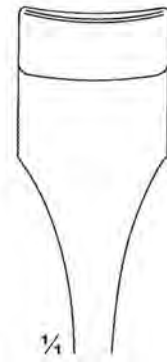

$\frac{1}{4}$

**339-04-28**

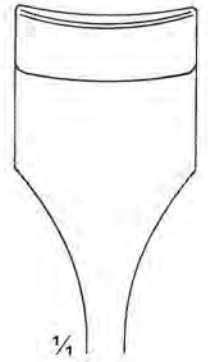

$\frac{1}{4}$

**339-05-28**

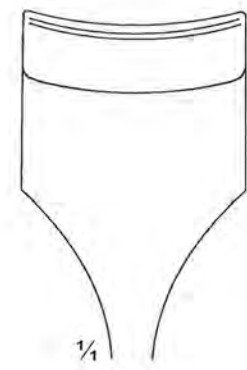

$\frac{1}{4}$

**339-06-28**

**Wundhaken ; Separadores  
Retractors ; Divaricatori  
Ecarteurs ; Afastadores**

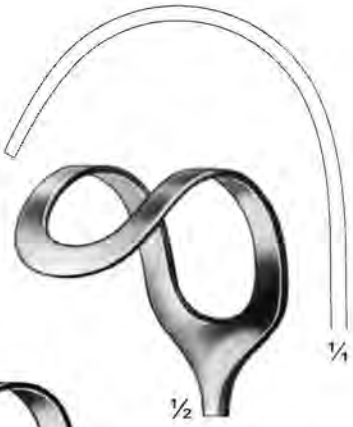

**340-01-25**  
45 X 45 mm



**340-02-25**  
45 X 50 mm

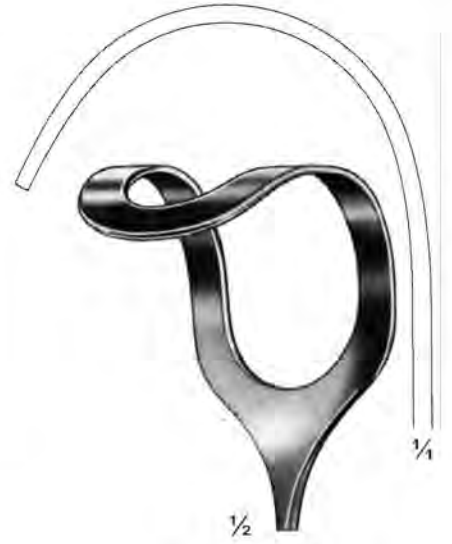

**340-03-25**  
55 X 70 mm



Middeldorpf  
**340-01-25 To 340-03-25**  
25 cm / 10"



Middeldorpf  
**340-04-21 To 340-06-23**

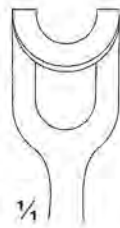

**340-04-21**  
**340-07-21**  
21.5 cm / 8 1/2"  
14 X 17 mm

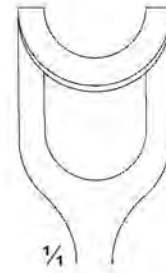

**340-05-22**  
**340-08-22**  
22 cm / 8 3/4"  
20 X 22 mm

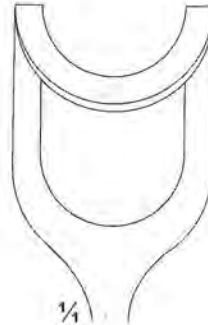

**340-06-23**  
**340-09-23**  
23.5 cm / 9 1/4"  
26 X 30 mm



Middeldorpf  
**340-07-21 To 340-09-23**

**Wundhaken ; Separadores  
Retractors ; Divaricatori  
Ecarteurs ; Afastadores**

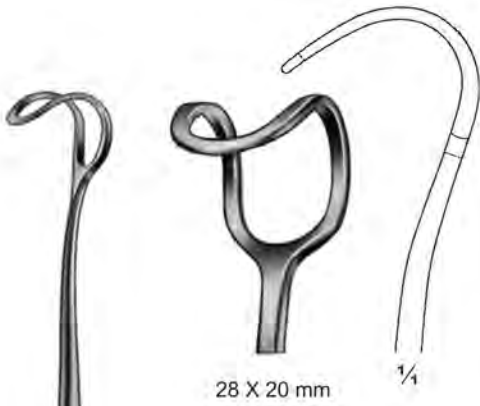

28 X 20 mm

$\frac{1}{4}$

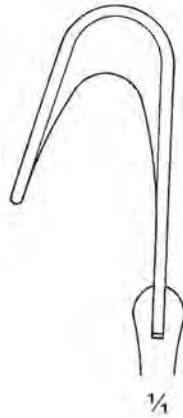

$\frac{1}{4}$



$\frac{1}{2}$

**341-02-20**  
20 cm / 8"



$\frac{1}{2}$

18 X 35 mm  
Moveable blade

$\frac{1}{2}$

Greene  
**341-01-23**  
23 cm / 9"



$\frac{1}{2}$

Büchs  
**341-03-20**  
20 cm / 8"



$\frac{1}{4}$

38 X 18 mm

$\frac{1}{4}$

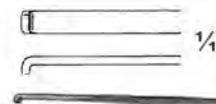

$\frac{1}{4}$



$\frac{1}{2}$

**341-04-19**  
19.5 cm / 7 $\frac{3}{4}$ "

**Wundhaken ; Separadores  
Retractors ; Divaricatori  
Ecarteurs ; Afastadores**

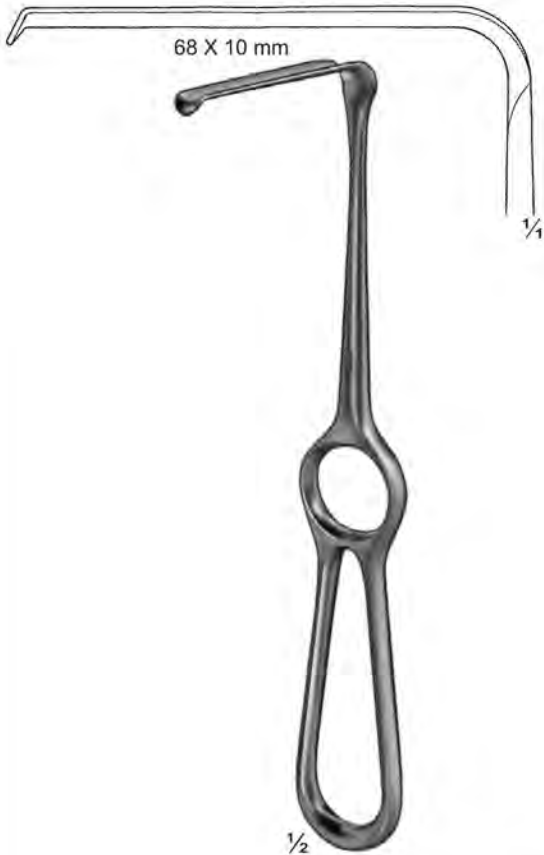

**Kramer  
342-01-21  
21 cm / 8 1/4"**

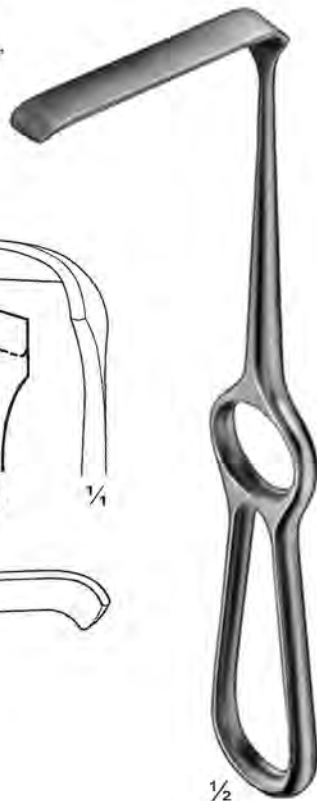
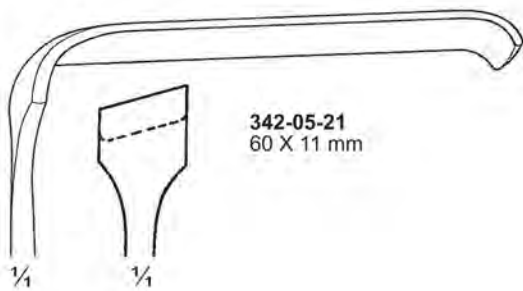
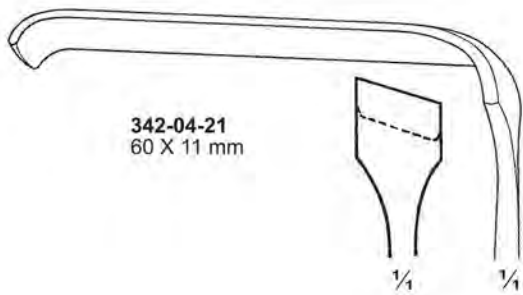

**Kirsch  
342-04-21 & 342-05-21  
21 cm / 8 1/4"**

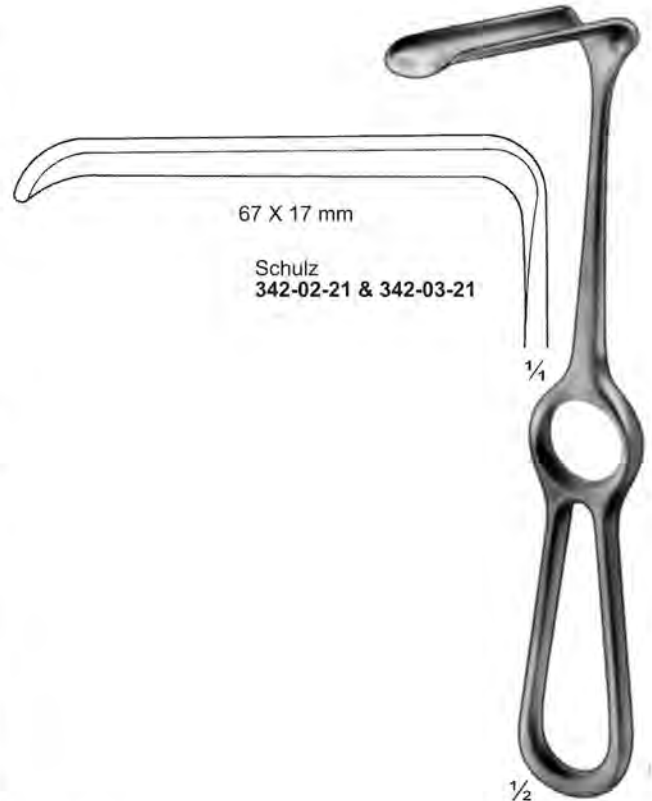

**Caspar  
342-06-21  
21 cm / 8 1/4"**



**Wundhaken ; Separadores  
Retractors ; Divaricatori  
Ecarteurs ; Afastadores**

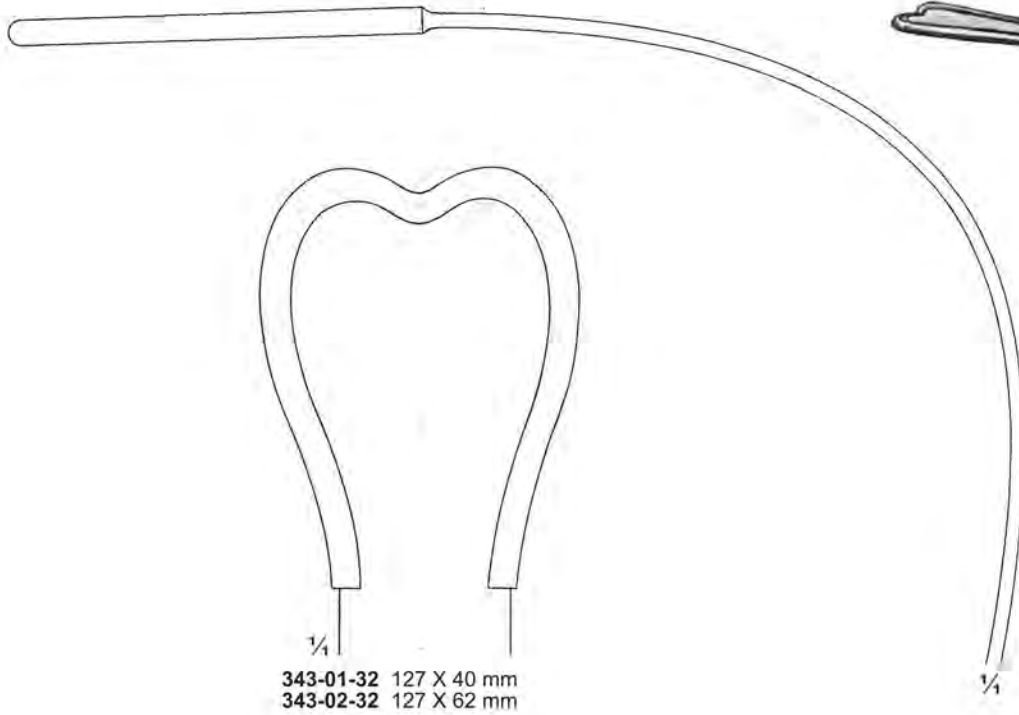

343-01-32 127 X 40 mm  
343-02-32 127 X 62 mm



1/2  
Harrington  
343-01-32 & 343-02-32  
32 cm / 12 1/2"



343-03-24 15 X 90 mm  
343-04-24 20 X 90 mm  
343-05-24 30 X 90 mm

343-06-24 35 X 110 mm  
343-07-24 40 X 110 mm

343-08-24 55 X 120 mm

Doyen-Stillé  
343-03-24 To 343-08-24  
24 cm / 9 1/2"



**Wundhaken ; Separadores  
Retractors ; Divaricatori  
Ecarteurs ; Afastadores**



**Tuffier**  
**344-01-21**  
21 cm / 8 1/4"



**Legueu**  
**344-04-27**  
27 cm / 10 1/2"



**Dockhorn**  
**344-02-21 & 344-03-21**  
21 cm / 8 1/4"

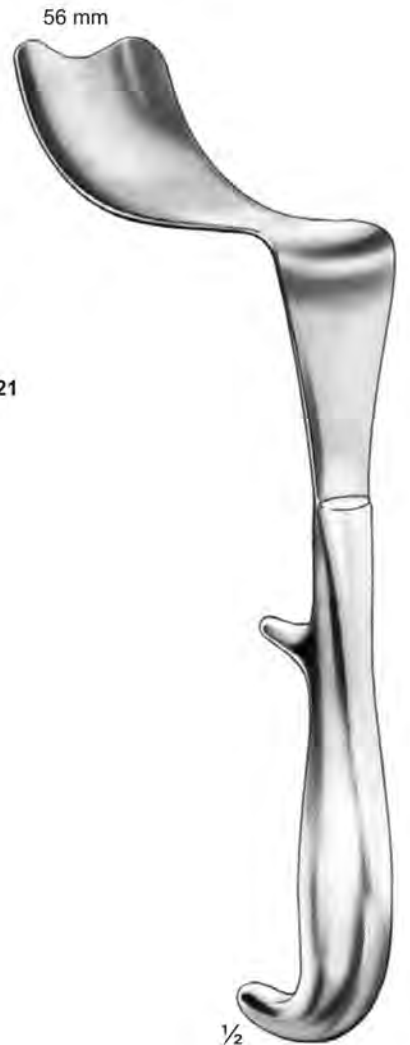
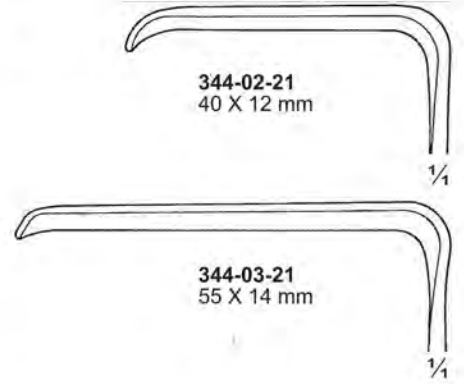

**Kocher**  
**344-05-26**  
26 cm / 10 1/4"

**Wundhaken ; Separadores  
Retractors ; Divaricatori  
Ecarteurs ; Afastadores**



$\frac{1}{2}$   
Ross  
345-01-27 To 345-06-27  
27 cm / 10 $\frac{1}{2}$ "  
(Aorta)



$\frac{1}{4}$   
345-01-27



$\frac{1}{4}$   
345-02-27



$\frac{1}{4}$   
345-03-27



$\frac{1}{4}$   
345-04-27



$\frac{1}{4}$   
345-05-27



$\frac{1}{4}$   
345-06-27



$\frac{1}{2}$   
Kocher-Wagner  
345-07-28 To 345-10-28  
28 cm / 11"



$\frac{1}{4}$   
345-07-28  
20 X 15 mm



$\frac{1}{4}$   
345-09-28  
64 X 25 mm



$\frac{1}{4}$   
345-08-28  
36 X 20 mm

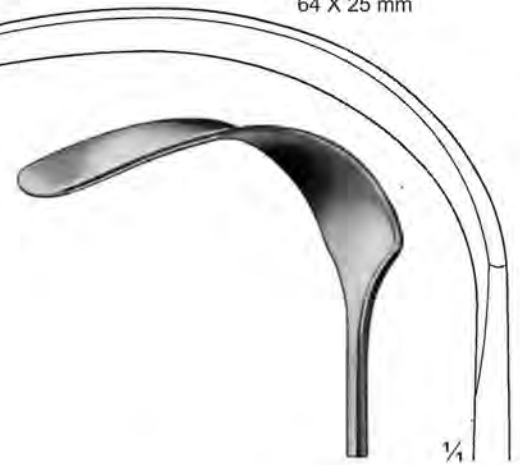

$\frac{1}{4}$   
345-10-28  
94 X 36 mm



**Wundhaken ; Separadores  
Retractors ; Divaricatori  
Ecarteurs ; Afastadores**



**346-01-19**  
15 X 15 mm

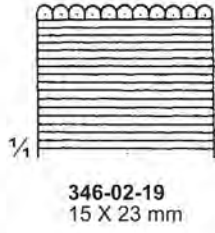

**346-02-19**  
15 X 23 mm



Crawford  
**346-01-19 & 346-02-19**  
19 cm / 7 1/2"  
(Aorta)

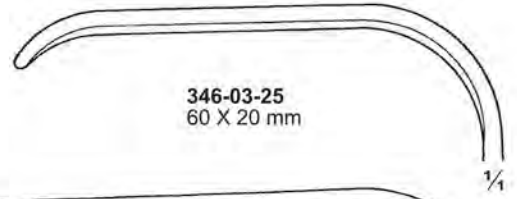

**346-03-25**  
60 X 20 mm

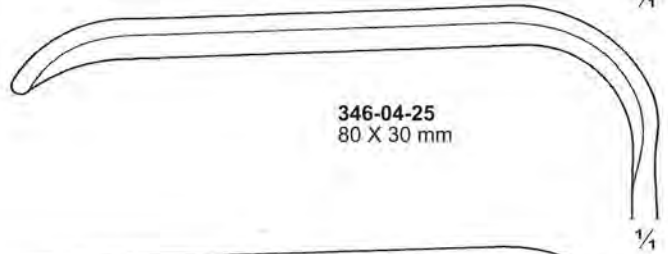

**346-04-25**  
80 X 30 mm

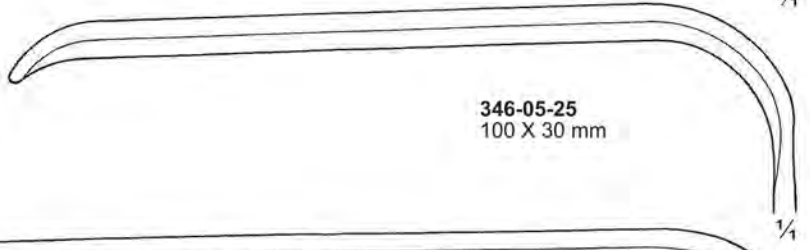

**346-05-25**  
100 X 30 mm

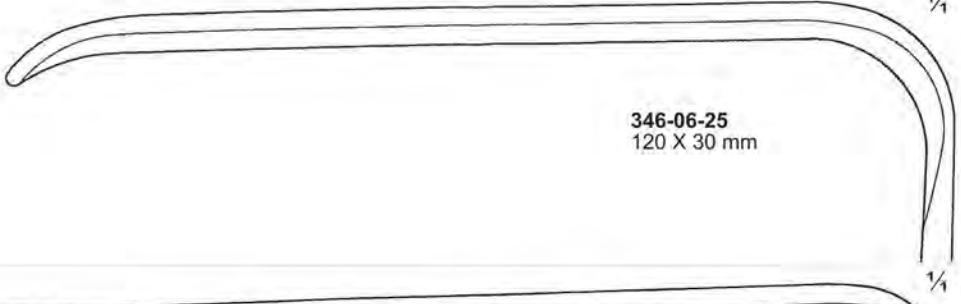

**346-06-25**  
120 X 30 mm

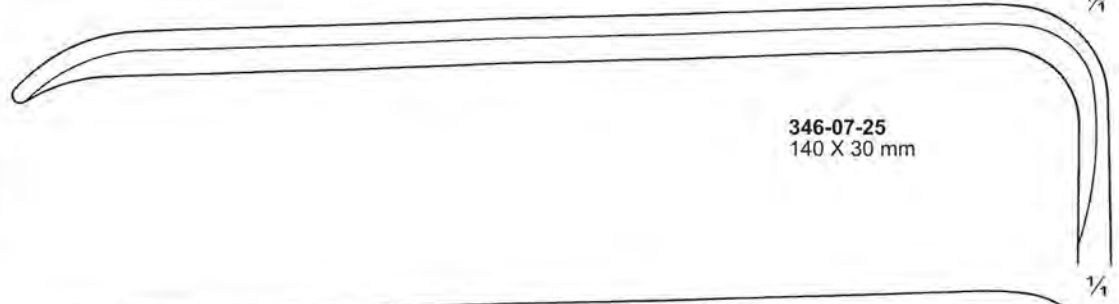

**346-07-25**  
140 X 30 mm

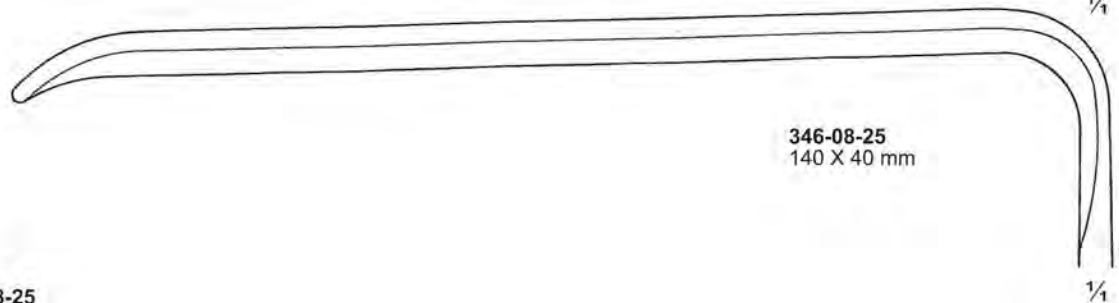

**346-08-25**  
140 X 40 mm

Hoesel  
**346-03-25 To 346-08-25**  
25 cm / 10"

**Wundhaken ; Separadores  
Retractors ; Divaricatori  
Ecarteurs ; Afastadores**



**347-01-24**  
20 X 25 mm



**347-02-24**  
25 X 32 mm



**347-03-24**  
38 X 38 mm



**347-04-24**  
20 X 50 mm

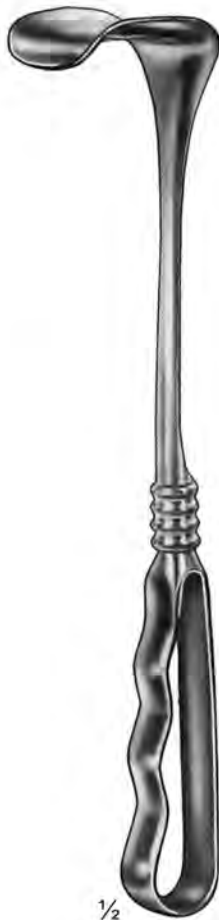

Richardson  
**347-01-24 To 347-04-24**  
24 cm / 9½"

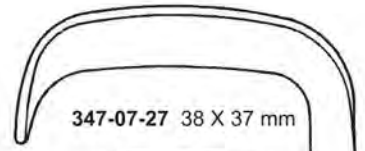

**347-07-27** 38 X 37 mm

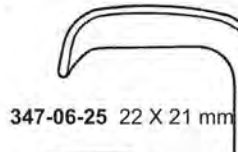

**347-06-25** 22 X 21 mm



**347-06-25** 29 X 30 mm

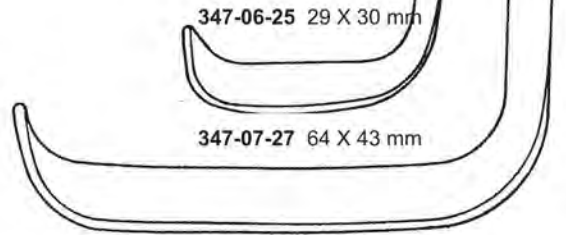

**347-07-27** 64 X 43 mm

Richardson-Eastman  
**347-05-02**  
Set of 2 consisting :  
**347-06-25** 25 cm / 10"  
**347-07-27** 27 cm / 10½"

**Wundhaken ; Separadores  
Retractors ; Divaricatori  
Ecarteurs ; Afastadores**



52 X 22 mm

1/2  
Richardson  
348-01-24  
24 cm / 9 1/2"



1/2

348-02-26  
40 X 50 mm



1/2

348-03-26  
50 X 65 mm



1/2

348-04-26  
65 X 75 mm



1/2

348-05-26  
75 X 90 mm



1/2

Kelly  
348-02-26 To 348-05-26  
26 cm / 10 1/4"

- 348-06-25 95 X 30 mm
- 348-07-25 100 X 50 mm
- 348-08-25 125 X 40 mm
- 348-09-25 130 X 50 mm
- 348-10-25 145 X 40 mm
- 348-11-25 155 X 50 mm
- 348-12-25 180 X 60 mm
- 348-13-25 210 X 70 mm

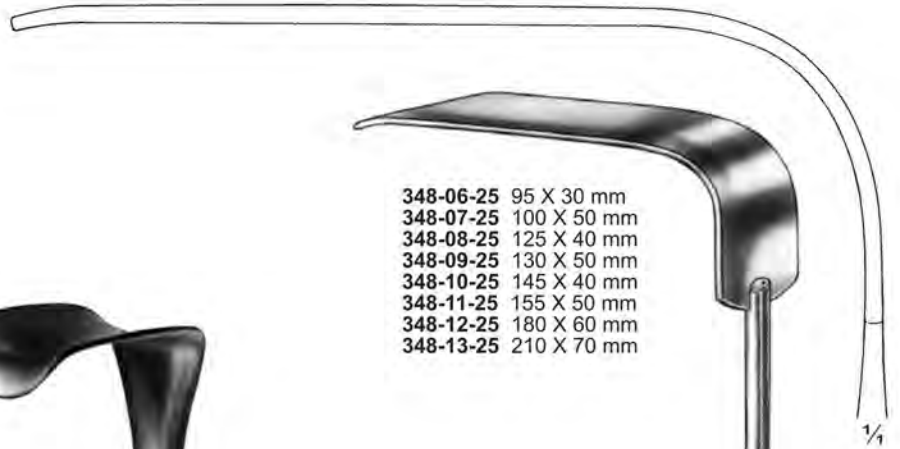

1/2

1/2  
348-06-25 To 348-13-25  
25 cm / 10"



**Wundhaken ; Separadores  
Retractors ; Divaricatori  
Ecarteurs ; Afastadores**

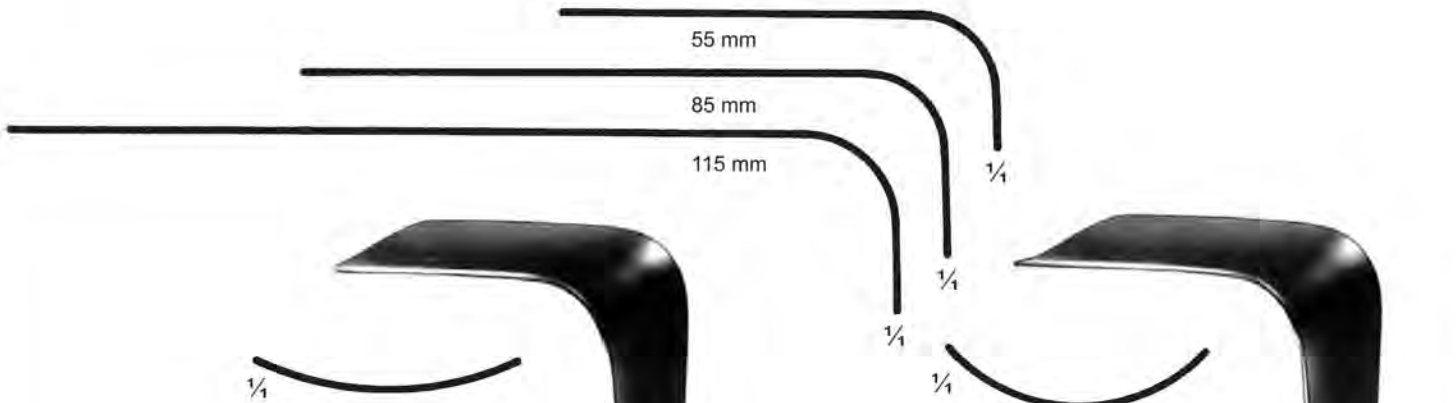

- 349-01-24 35 X 55 mm
- 349-02-24 35 X 85 mm
- 349-03-24 35 X 115 mm
- 349-04-24 45 X 55 mm
- 349-05-24 45 X 85 mm
- 349-06-24 45 X 115 mm
- 349-07-24 60 X 55 mm
- 349-08-24 60 X 85 mm
- 349-09-24 60 X 115 mm

- 349-11-24 35 X 55 mm
- 349-12-24 35 X 85 mm
- 349-13-24 35 X 115 mm
- 349-14-24 45 X 55 mm
- 349-15-24 45 X 85 mm
- 349-16-24 45 X 115 mm
- 349-17-24 60 X 55 mm
- 349-18-24 60 X 85 mm
- 349-19-24 60 X 115 mm



55 X 85 mm

Doyen  
349-10-25  
25 cm / 10"



Doyen  
349-0124 To 349-09-24  
24 cm / 9½"

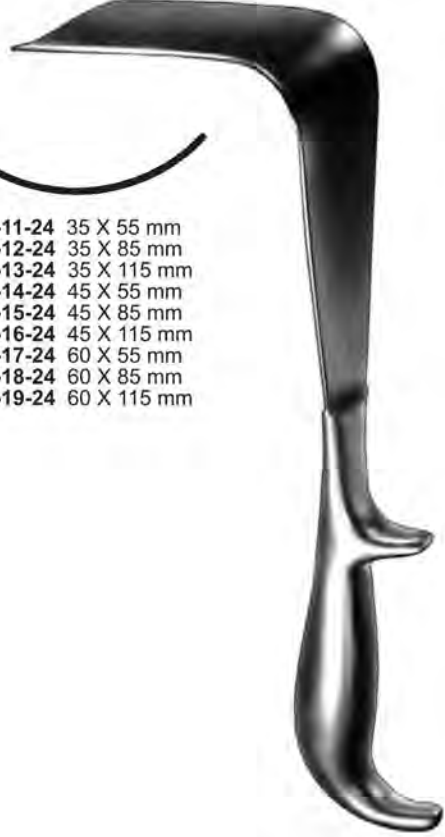

Doyen  
349-11-24 To 349-19-24  
24 cm / 9½"

**Wundhaken ; Separadores  
Retractors ; Divaricatori  
Ecarteurs ; Afastadores**

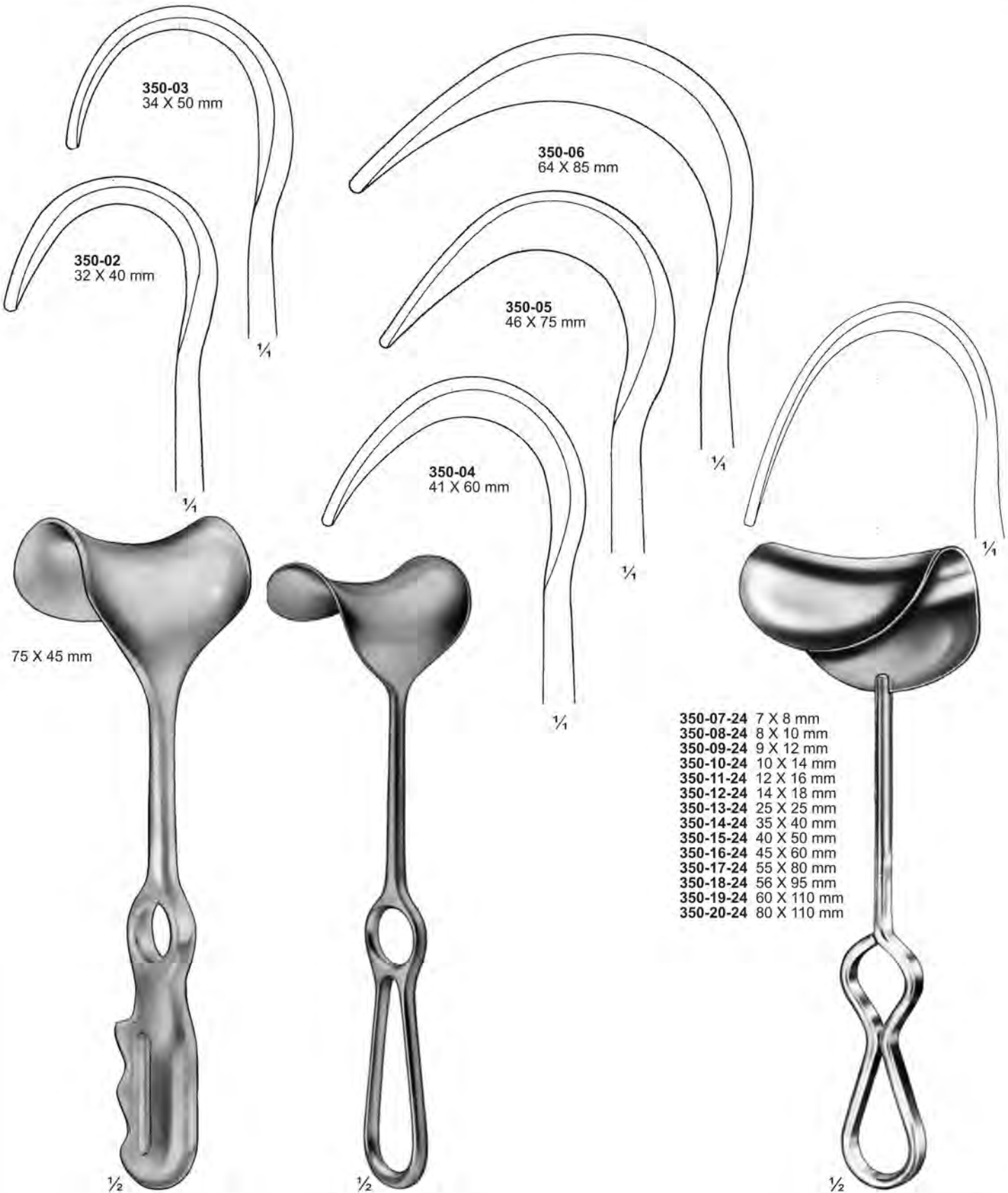

**350-03**  
34 X 50 mm

**350-02**  
32 X 40 mm

**350-06**  
64 X 85 mm

**350-05**  
46 X 75 mm

**350-04**  
41 X 60 mm

75 X 45 mm

- 350-07-24 7 X 8 mm
- 350-08-24 8 X 10 mm
- 350-09-24 9 X 12 mm
- 350-10-24 10 X 14 mm
- 350-11-24 12 X 16 mm
- 350-12-24 14 X 18 mm
- 350-13-24 25 X 25 mm
- 350-14-24 35 X 40 mm
- 350-15-24 40 X 50 mm
- 350-16-24 45 X 60 mm
- 350-17-24 55 X 80 mm
- 350-18-24 56 X 95 mm
- 350-19-24 60 X 110 mm
- 350-20-24 80 X 110 mm

**Fritsch**  
**350-01-25**  
25 cm / 10"

**Fritsch**  
**350-02-24 To 350-06-24**  
24 cm / 9½"

**Fritsch**  
**350-07-24 To 350-20-24**  
24 cm / 9½"

**Wundhaken ; Separadores  
Retractors ; Divaricatori  
Ecarteurs ; Afastadores**



**351-01**  
78 X 82 mm



$\frac{1}{2}$   
Doyen  
**351-01-26**  
26 cm / 10 $\frac{1}{4}$ "

- 351-04-32** 100 X 15 mm
- 351-05-32** 100 X 25 mm
- 351-06-32** 100 X 30 mm
- 351-07-32** 100 X 35 mm
- 351-08-32** 100 X 40 mm
- 351-09-32** 130 X 20 mm
- 351-10-32** 130 X 25 mm
- 351-11-32** 130 X 30 mm
- 351-12-32** 130 X 35 mm
- 351-13-32** 130 X 40 mm
- 351-14-32** 155 X 40 mm



**351-02-24** 50 X 40 mm  
**351-03-24** 80 X 60 mm

$\frac{1}{3}$   
Fritsch  
**351-02-24 & 351-03-24**  
24 cm / 9 $\frac{1}{2}$ "



$\frac{1}{2}$   
Breisky  
**351-04-32 To 351-14-32**  
32 cm / 12 $\frac{3}{4}$ "

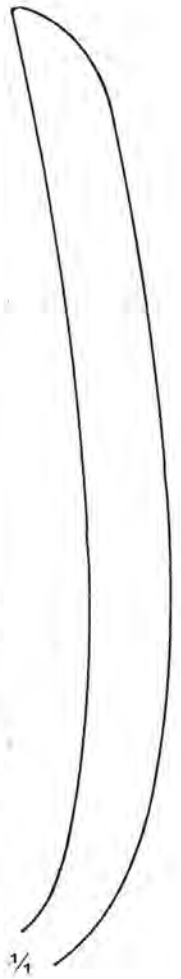



**Wundhaken ; Separadores  
Retractors ; Divaricatori  
Ecarteurs ; Afastadores**

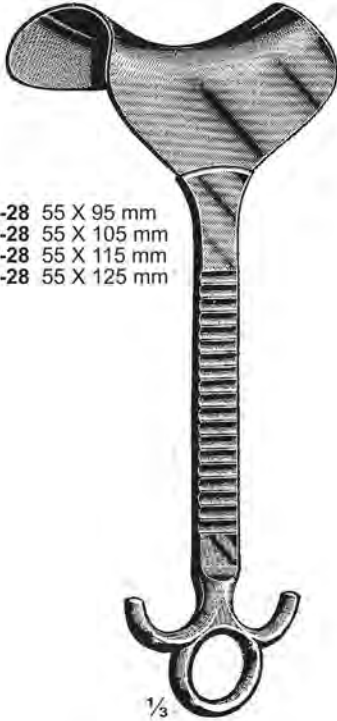

352-01-28 55 X 95 mm  
352-02-28 55 X 105 mm  
352-03-28 55 X 115 mm  
352-04-28 55 X 125 mm

Doyen  
352-01-28 To 352-04-28  
28 cm / 11"

1/3

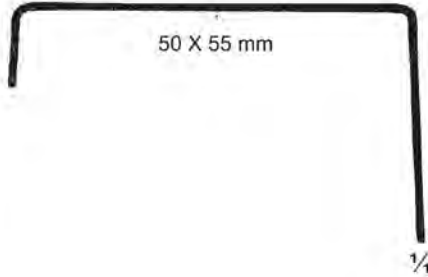

Morris  
352-05-21  
21 cm / 8 1/4"

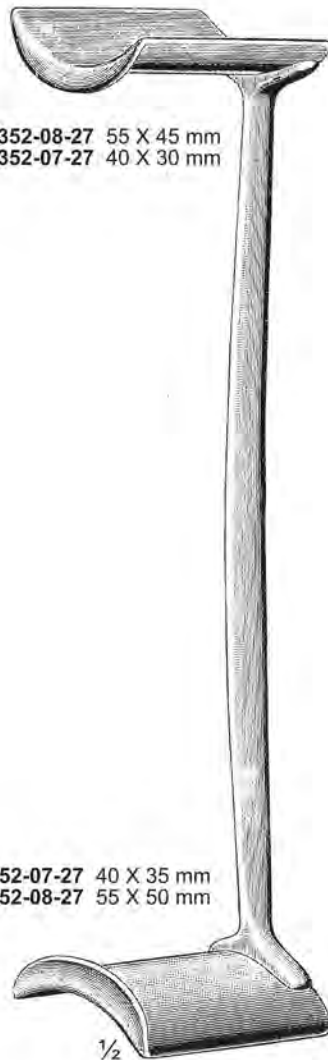

352-08-27 55 X 45 mm  
352-07-27 40 X 30 mm

352-07-27 40 X 35 mm  
352-08-27 55 X 50 mm

Morris  
352-07-27 & 352-08-27  
27 cm / 10 1/2"

1/2



32 X 40 mm

25 X 32 mm

Goelet  
352-06-19  
19 cm / 7 1/2"

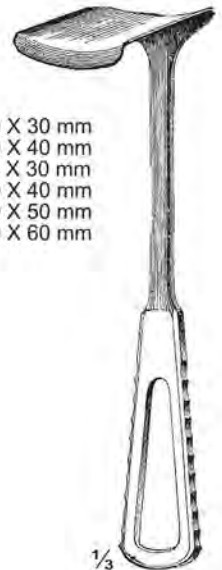

352-09-23 30 X 30 mm  
352-10-23 40 X 40 mm  
352-11-23 50 X 30 mm  
352-12-23 50 X 40 mm  
352-13-23 50 X 50 mm  
352-14-23 50 X 60 mm

Morris  
352-09-23 To 352-14-23  
23 cm / 9"

1/3

**Wundhaken ; Separadores  
Retractors ; Divaricatori  
Ecarteurs ; Afastadores**

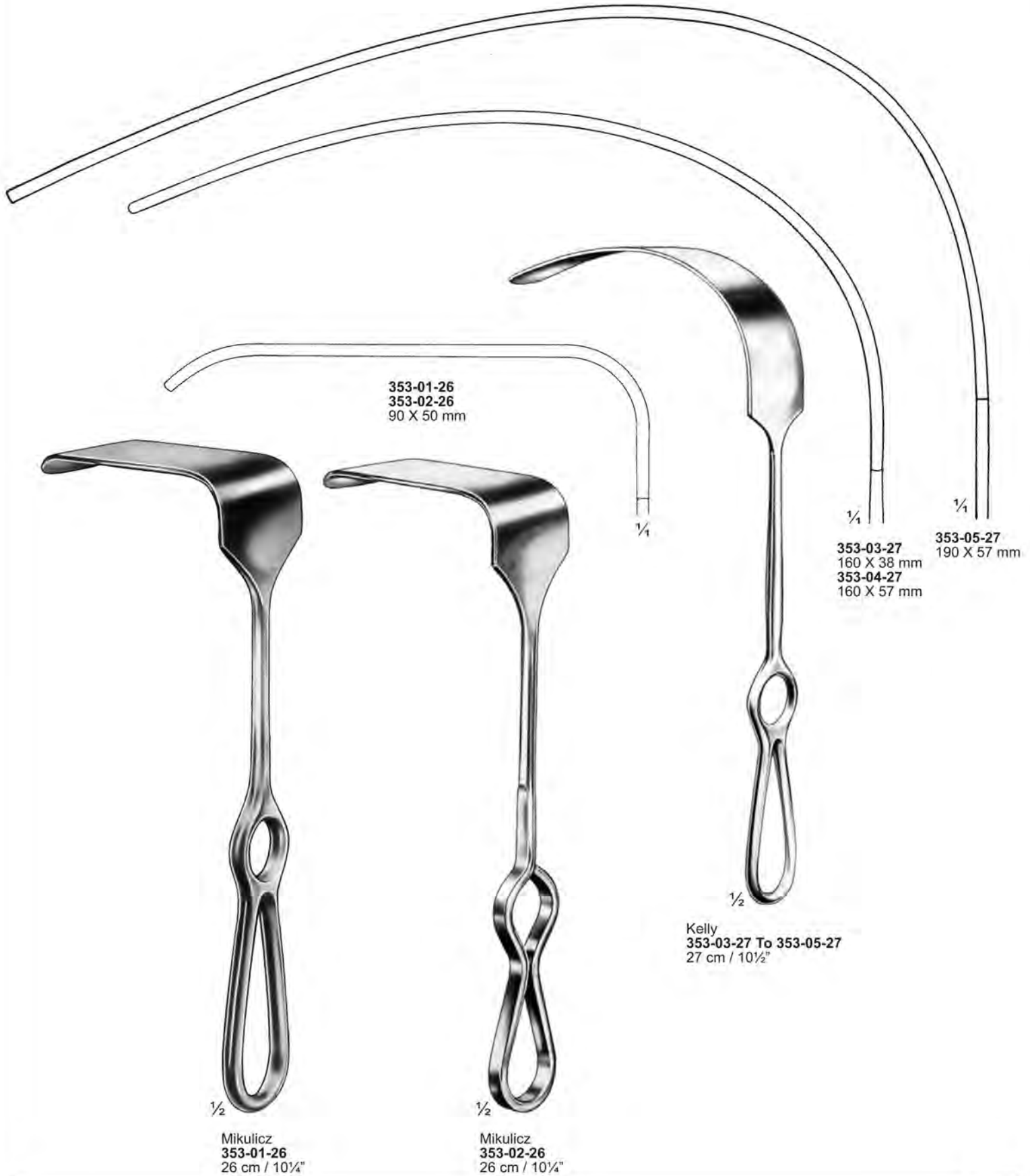

**Wundhaken ; Separadores  
Retractors ; Divaricatori  
Ecarteurs ; Afastadores**

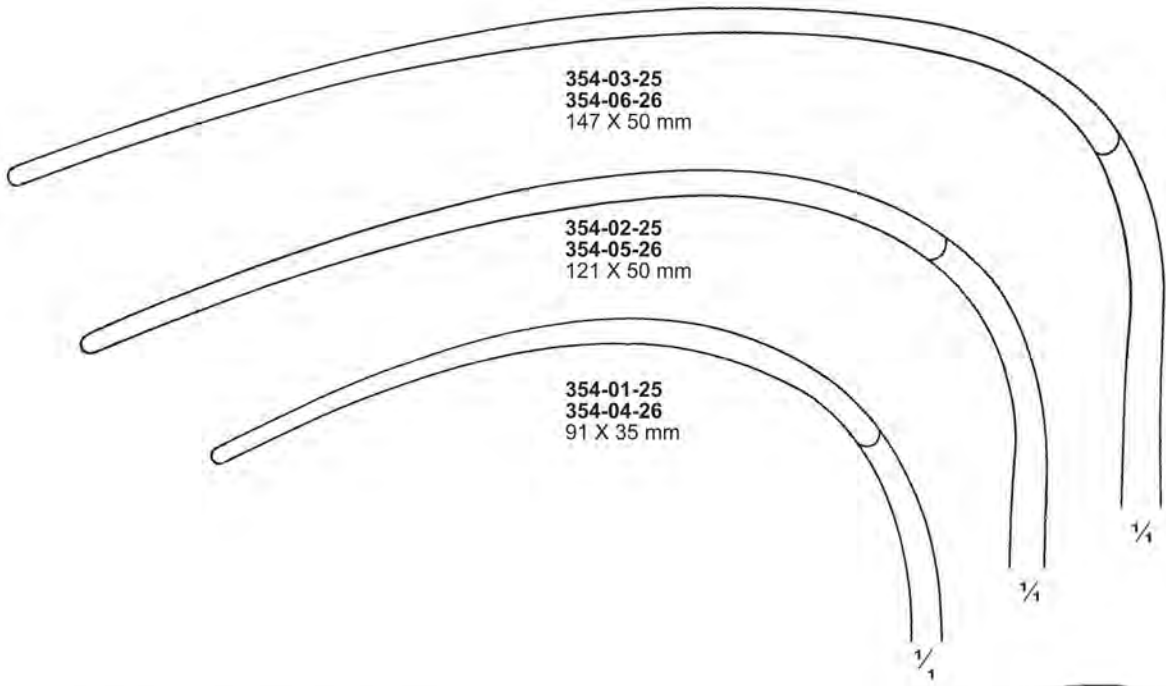

Mikulicz  
354-01-25 To 354-03-25  
25 cm / 10"



Mikulicz  
354-04-26 To 354-06-26  
26 cm / 10 1/4"

**Wundhaken ; Separadores  
Retractors ; Divaricatori  
Ecarteurs ; Afastadores**

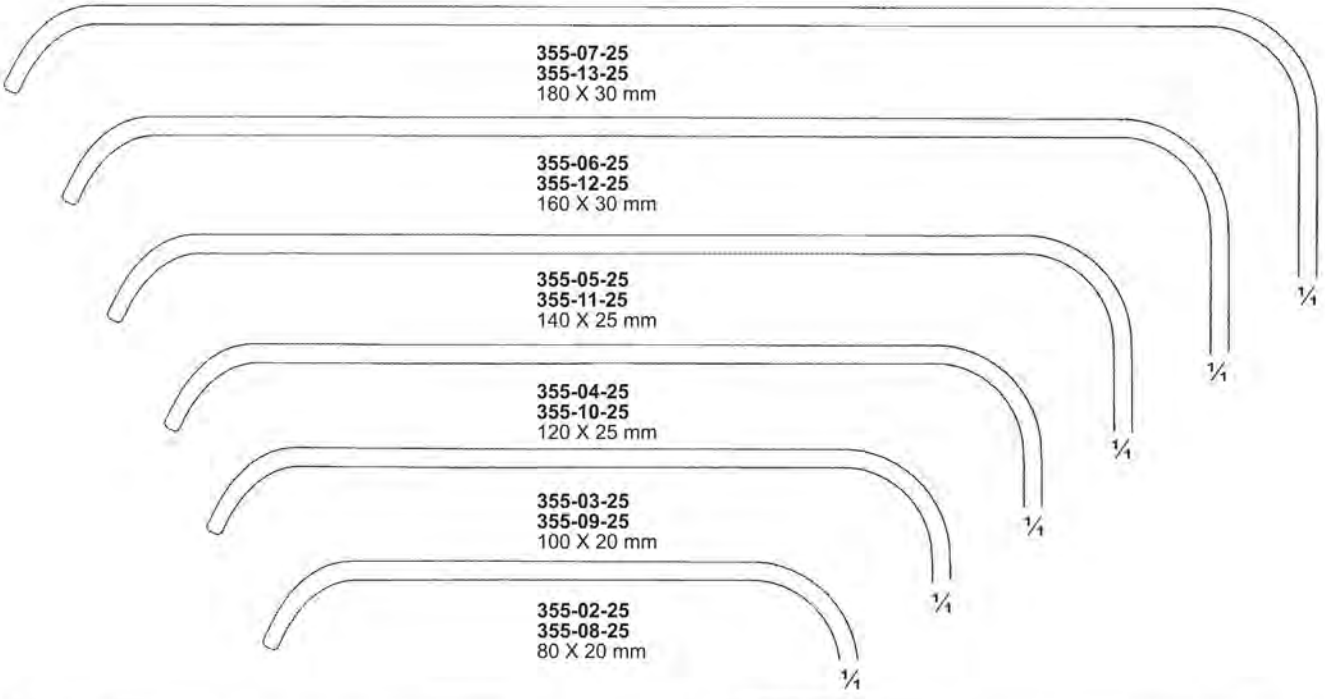

Morrison Davies  
355-01-24  
24 cm / 9½"

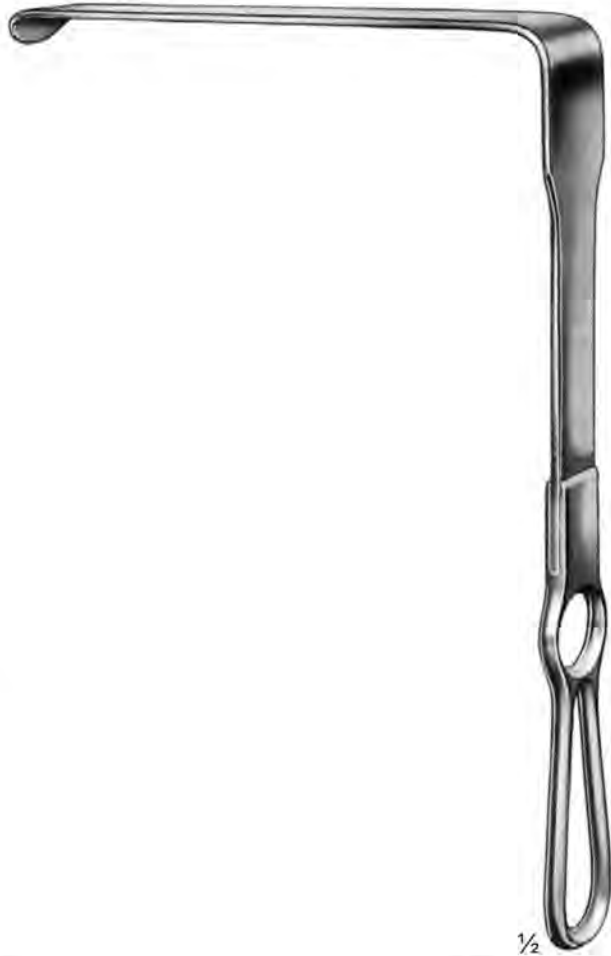

Brunner  
355-02-25 To 355-07-25  
25 cm / 10"

Brunner  
355-08-25 To 355-13-25  
25 cm / 10"



**Wundhaken ; Separadores  
Retractors ; Divaricatori  
Ecarteurs ; Afastadores**

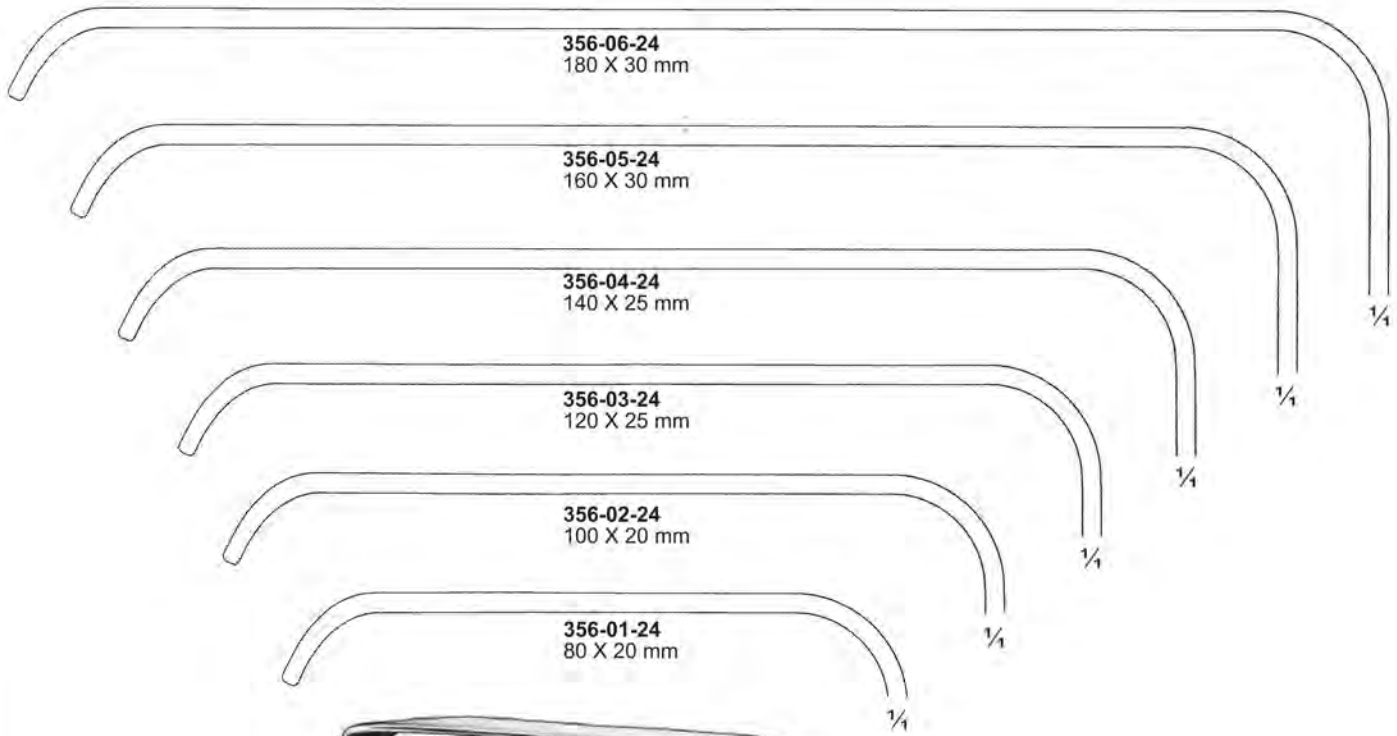

Brunner  
356-01-24 To 356-06-24  
24 cm / 9½"



**Wundhaken ; Separadores  
Retractors ; Divaricatori  
Ecarteurs ; Afastadores**

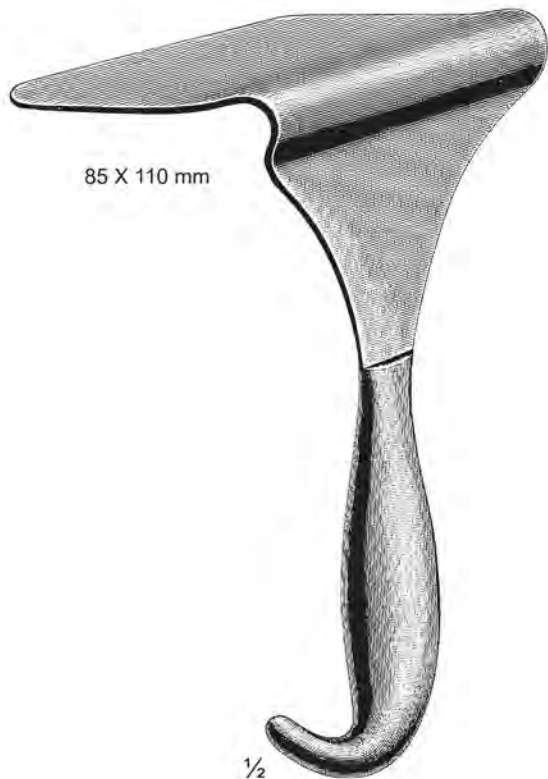
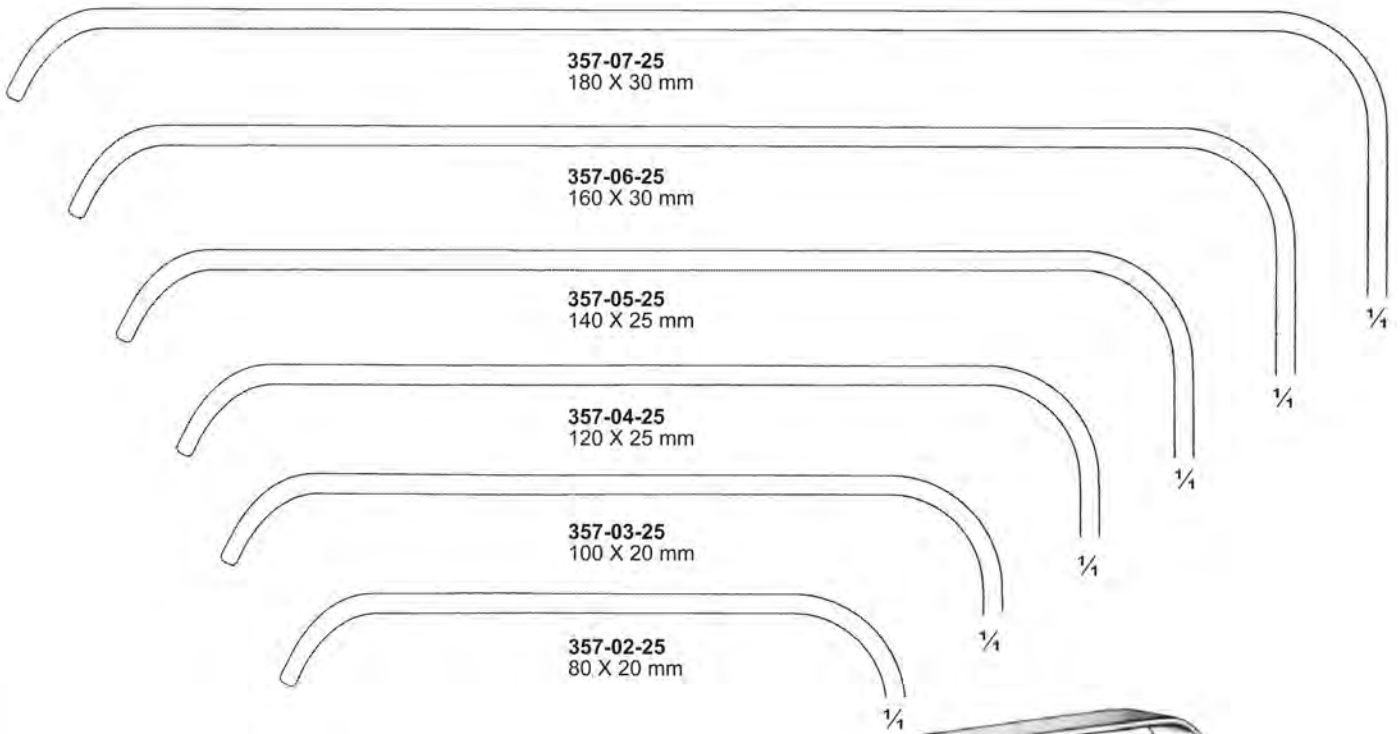

Albarran  
357-01-20  
20 cm / 8"



Brunner  
357-02-25 To 357-07-25  
25 cm / 10"



**Wundhaken ; Separadores  
Retractors ; Divaricatori  
Ecarteurs ; Afastadores**

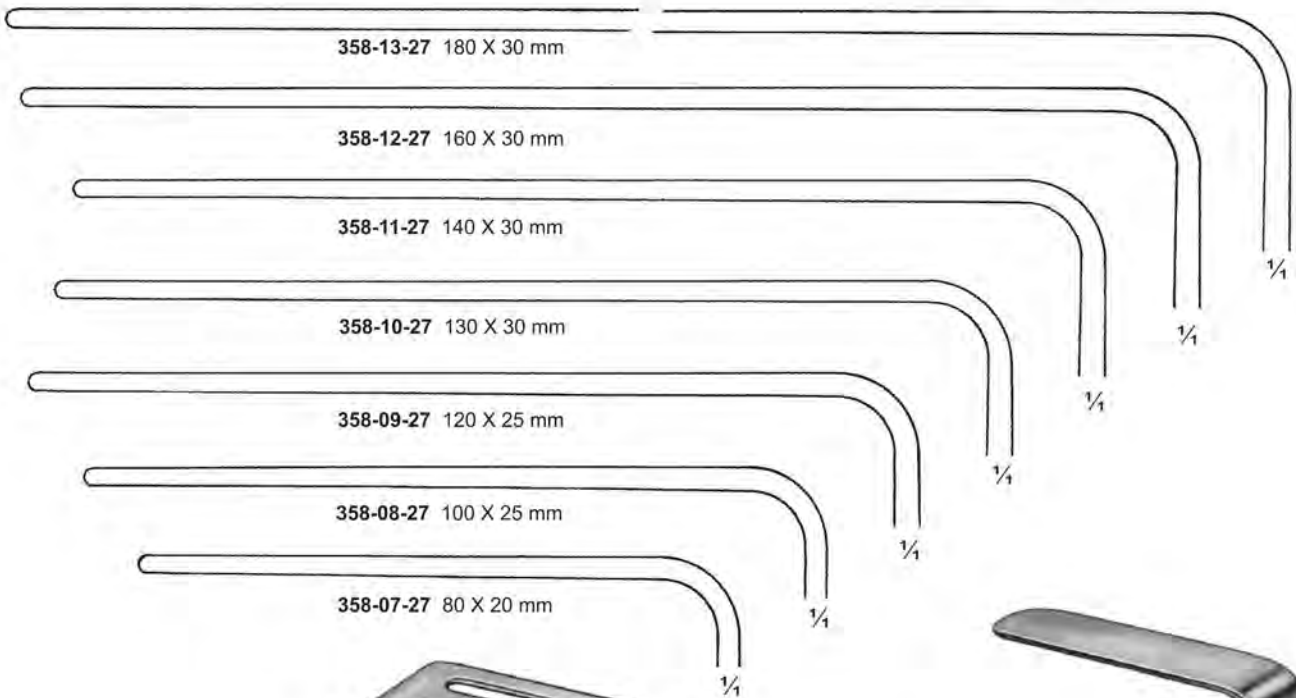

Sauerbruch  
358-01-25 To 358-03-25  
25 cm / 10"

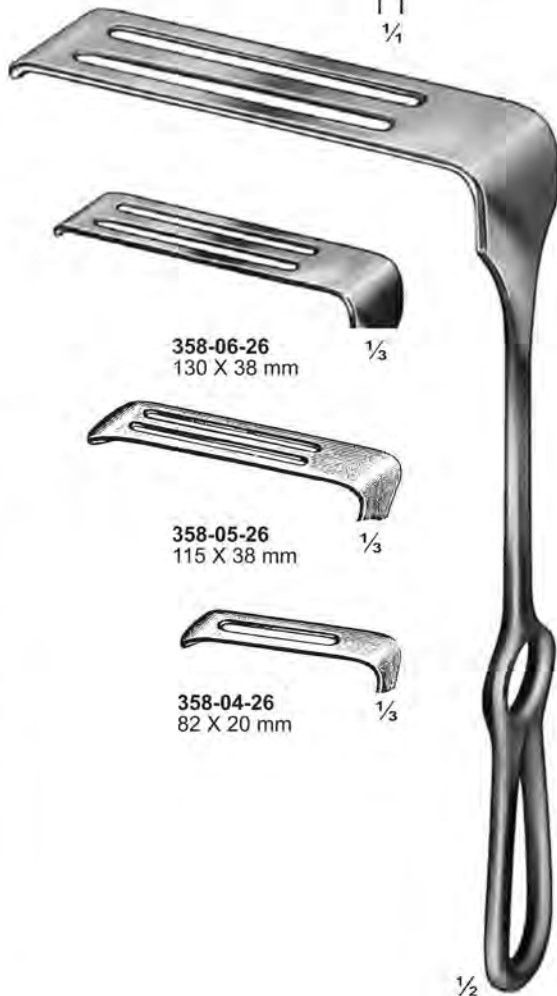

Sauerbruch  
358-04-26 To 358-06-26  
26 cm / 10 1/4"



Bruener  
358-07-27 To 358-13-27  
27.5 cm / 10 3/4"



**Wundhaken ; Separadores  
Retractors ; Divaricatori  
Ecarteurs ; Afastadores**

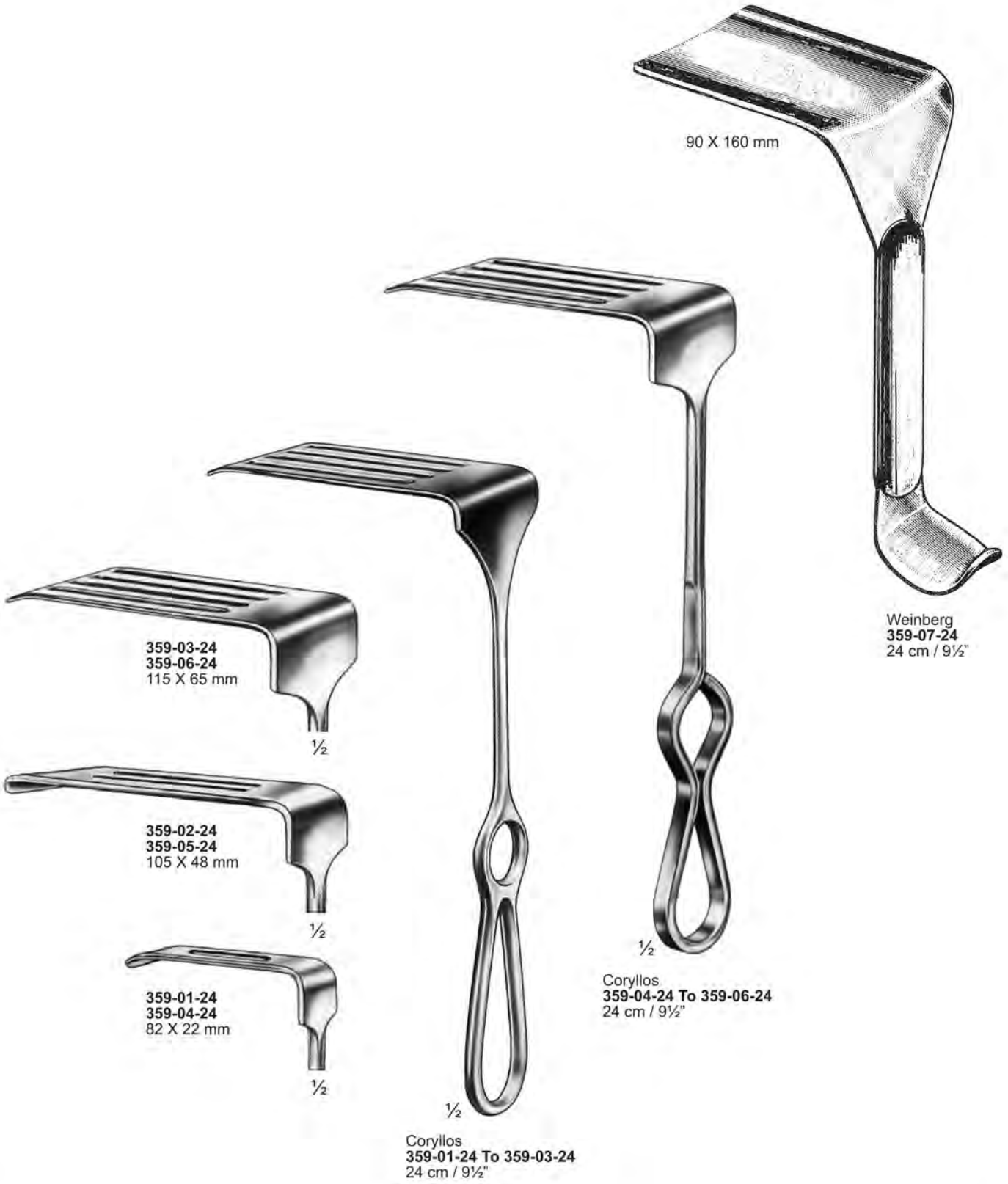

**359-03-24  
359-06-24  
115 X 65 mm**

1/2

**359-02-24  
359-05-24  
105 X 48 mm**

1/2

**359-01-24  
359-04-24  
82 X 22 mm**

1/2

90 X 160 mm

**Weinberg  
359-07-24  
24 cm / 9 1/2"**

1/2

**Coryllos  
359-04-24 To 359-06-24  
24 cm / 9 1/2"**

1/2

**Coryllos  
359-01-24 To 359-03-24  
24 cm / 9 1/2"**



**Wundhaken ; Separadores  
Retractors ; Divaricatori  
Ecarteurs ; Afastadores**



23 X 85 mm

**Coryllos  
360-01-23**  
23 cm / 9"



44 X 105 mm

**Coryllos  
360-02-23**  
23 cm / 9"



65 X 115 mm

**Coryllos  
360-03-23**  
23 cm / 9"

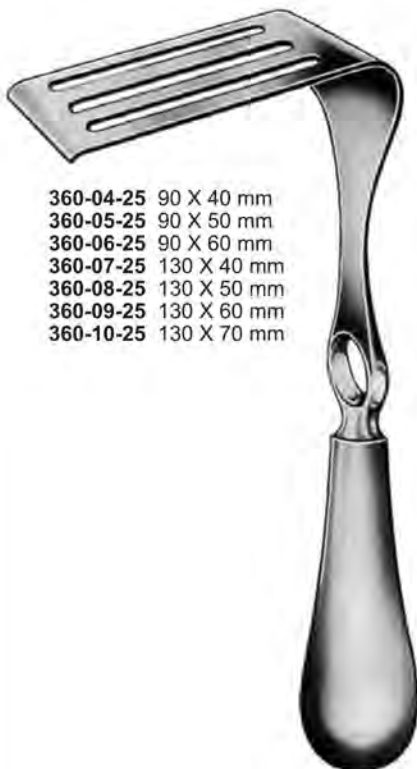

- 360-04-25 90 X 40 mm
- 360-05-25 90 X 50 mm
- 360-06-25 90 X 60 mm
- 360-07-25 130 X 40 mm
- 360-08-25 130 X 50 mm
- 360-09-25 130 X 60 mm
- 360-10-25 130 X 70 mm

**Rehn  
360-04-25 To 360-10-25**  
25 cm / 10"

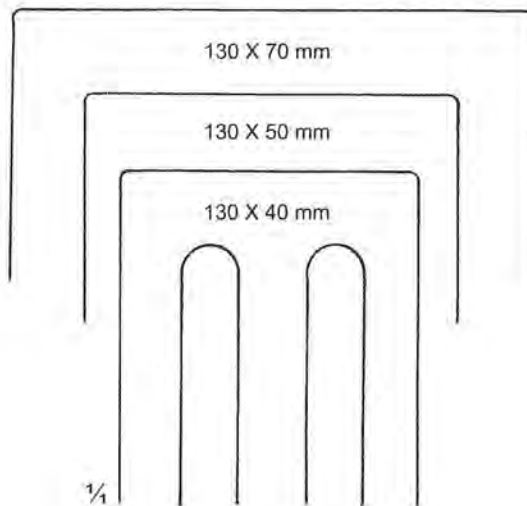

- 360-11-33 90 X 40 mm
- 360-12-33 90 X 50 mm
- 360-13-33 90 X 60 mm
- 360-14-33 130 X 40 mm
- 360-15-33 130 X 50 mm
- 360-16-33 130 X 60 mm
- 360-17-33 130 X 70 mm

**Rehn  
360-11-33 To 360-17-33**  
33 cm / 13 1/4"

**Wundhaken ; Separadores  
Retractors ; Divaricatori  
Ecarteurs ; Afastadores**

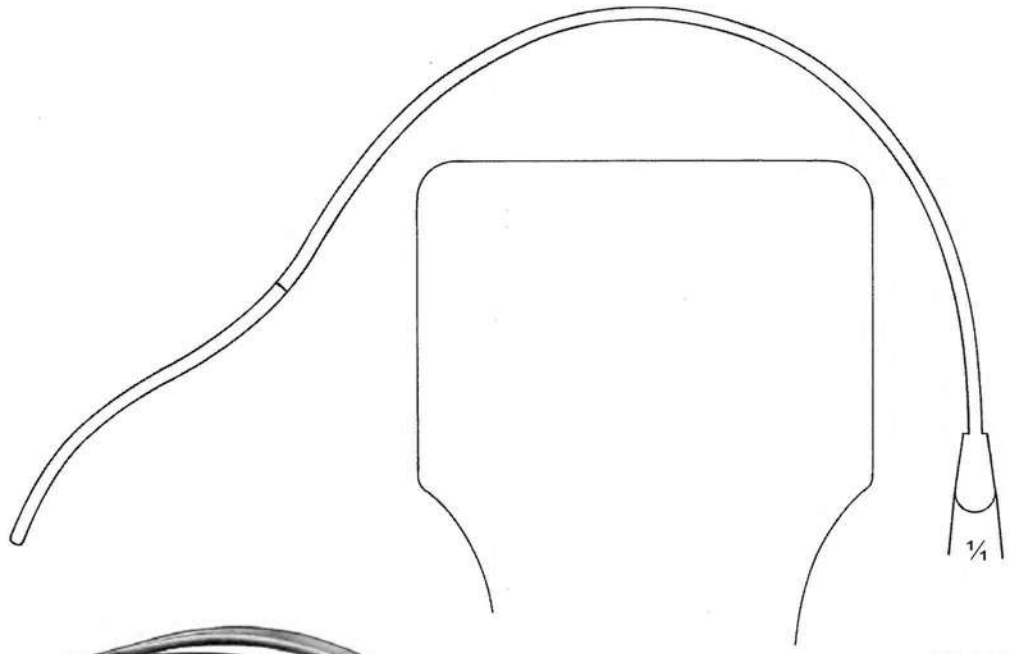

1/4

1/4

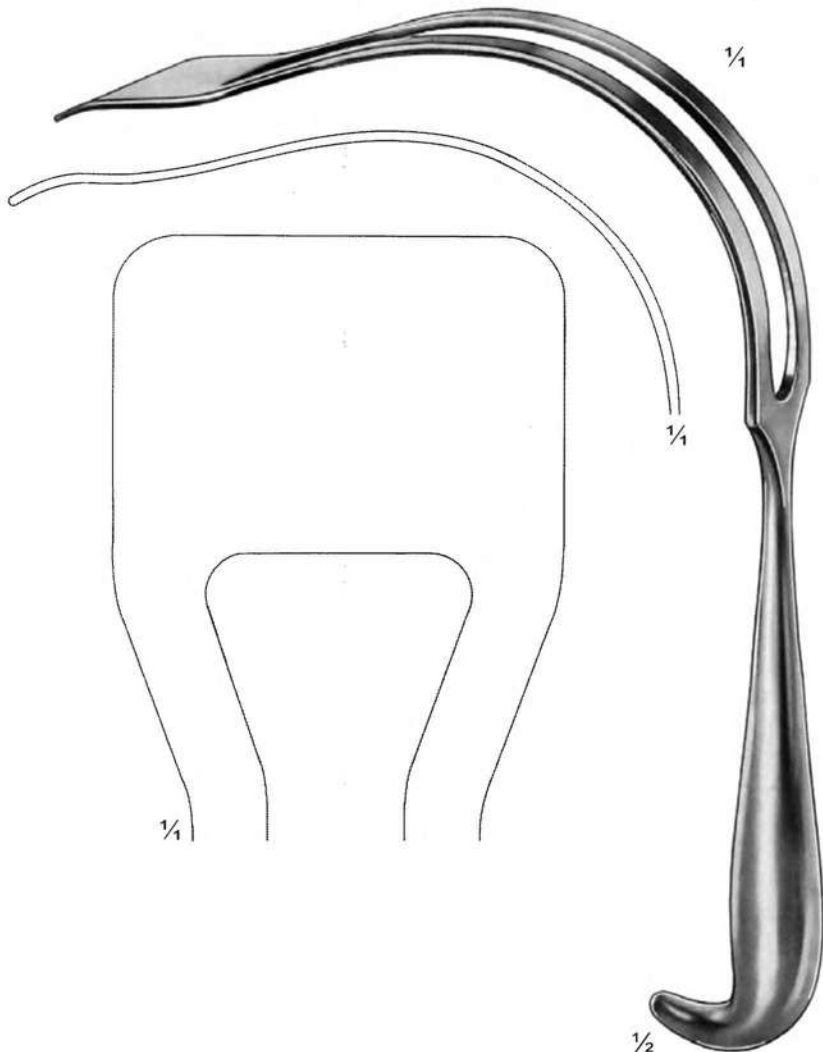

1/4

1/4

1/2

Polloson  
361-01-27  
27.5 cm / 10 3/4"



1/2

Polloson  
361-02-27  
27.5 cm / 10 3/4"

**Wundhaken ; Separadores  
Retractors ; Divaricatori  
Ecarteurs ; Afastadores**

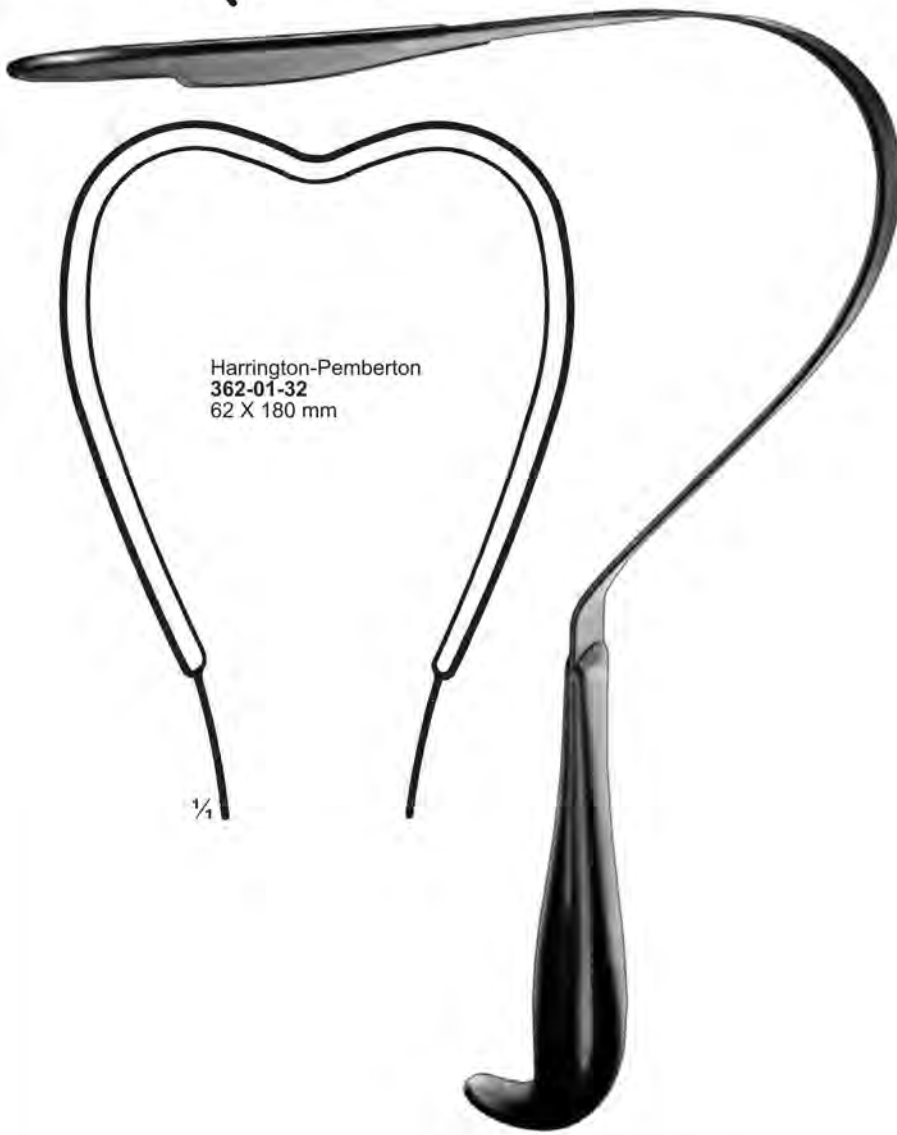
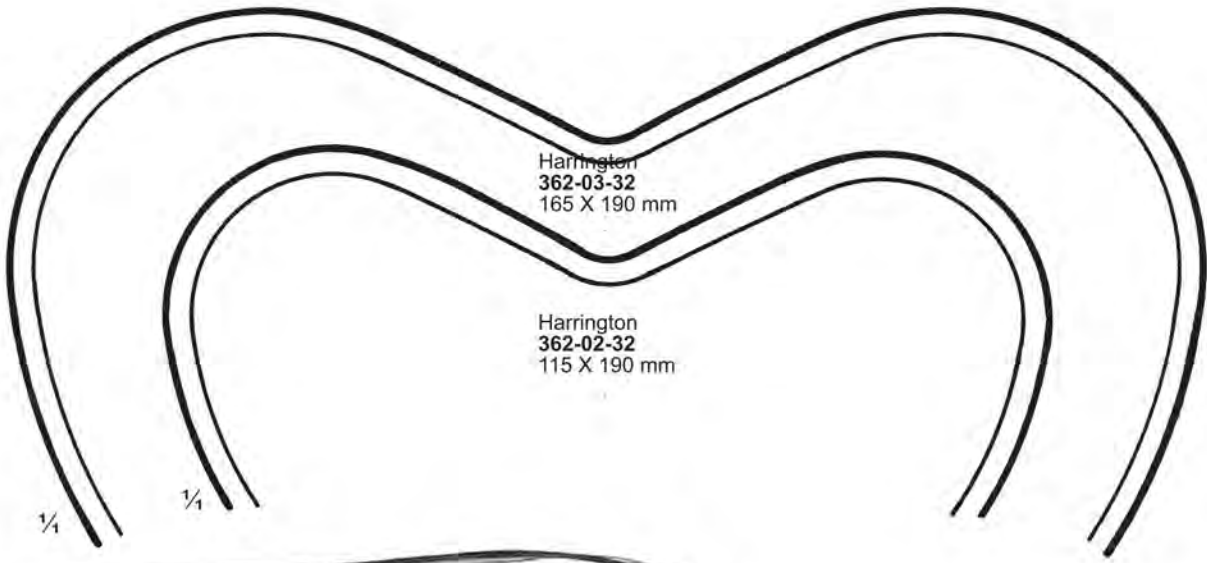

362-01-32 To 362-03-32  
32 cm / 12 1/4"

Harrington-Baby  
362-04-25  
25 cm / 10"

**Wundhaken ; Separadores  
Retractors ; Divaricatori  
Ecarteurs ; Afastadores**

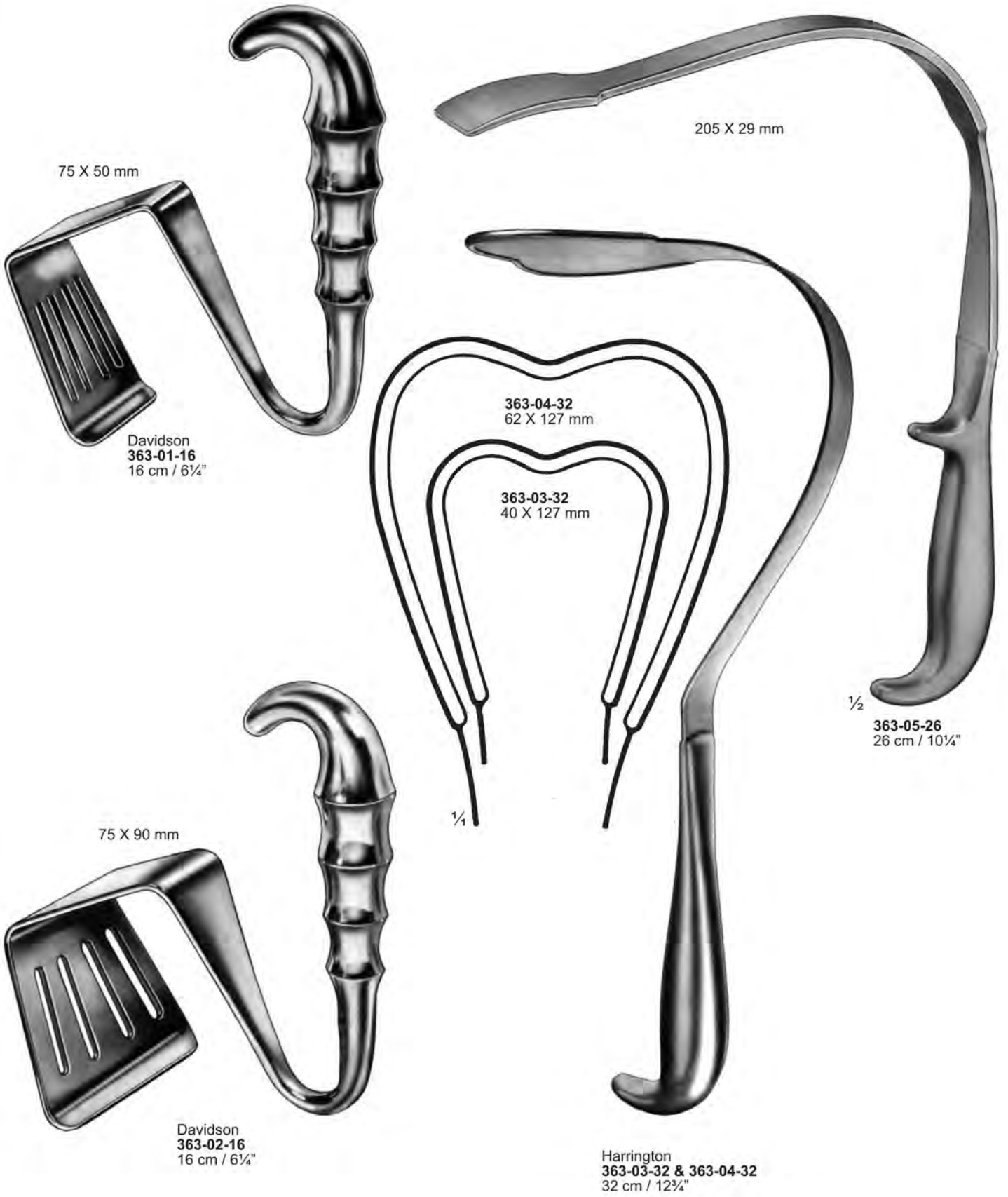

**Wundhaken ; Separadores  
Retractors ; Divaricatori  
Ecarteurs ; Afastadores**





Deaver  
365-01-30  
30 cm / 12"



Deaver  
365-02-30  
30 cm / 12"



Deaver  
365-03-30  
30 cm / 12"



Deaver  
With comfort handle

365-04-23	23 cm / 9"	25 mm
365-05-30	30 cm / 12"	25 mm
365-06-33	33 cm / 13"	25 mm
365-07-36	36 cm / 14"	25 mm
365-08-30	30 cm / 12"	38 mm
365-09-30	30 cm / 12"	50 mm
365-10-30	30 cm / 12"	75 mm
365-11-36	36 cm / 14"	100 mm

**Wundhaken ; Separadores  
Retractors ; Divaricatori  
Ecarteurs ; Afastadores**

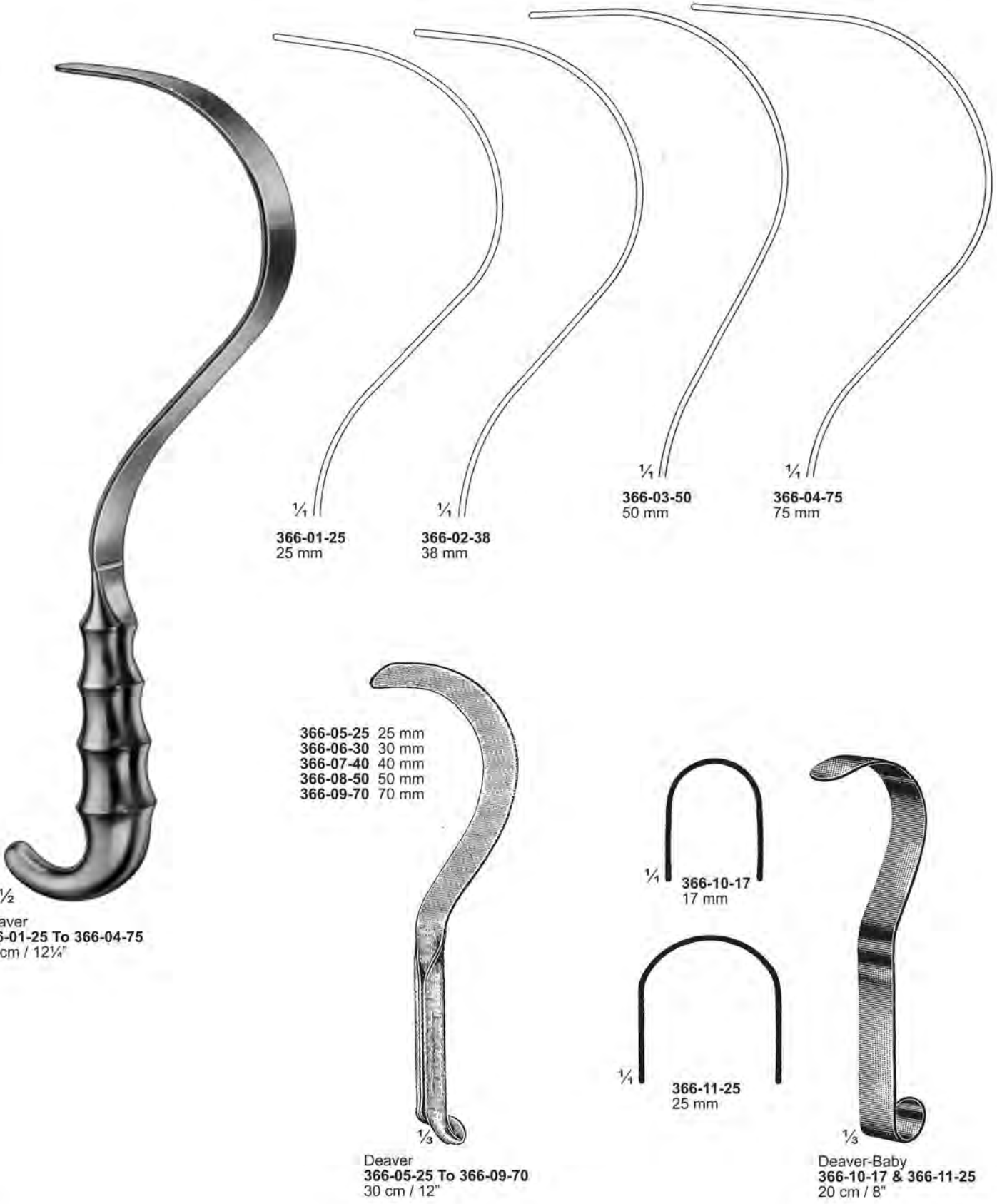

$\frac{1}{4}$   
**366-01-25**  
25 mm

$\frac{1}{4}$   
**366-02-38**  
38 mm

$\frac{1}{4}$   
**366-03-50**  
50 mm

$\frac{1}{4}$   
**366-04-75**  
75 mm

**366-05-25** 25 mm  
**366-06-30** 30 mm  
**366-07-40** 40 mm  
**366-08-50** 50 mm  
**366-09-70** 70 mm

$\frac{1}{4}$   
**366-10-17**  
17 mm

$\frac{1}{4}$   
**366-11-25**  
25 mm

$\frac{1}{2}$   
Deaver  
**366-01-25 To 366-04-75**  
31 cm / 12 $\frac{1}{4}$ "

$\frac{1}{3}$   
Deaver  
**366-05-25 To 366-09-70**  
30 cm / 12"

$\frac{1}{3}$   
Deaver-Baby  
**366-10-17 & 366-11-25**  
20 cm / 8"

**Wundhaken ; Separadores  
Retractors ; Divaricatori  
Ecarteurs ; Afastadores**

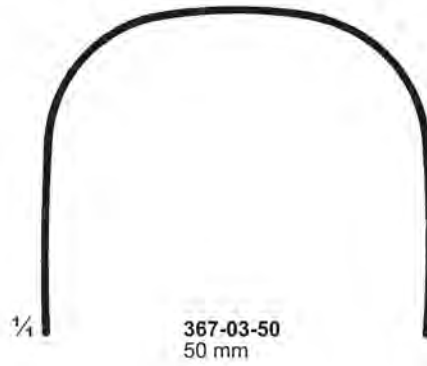
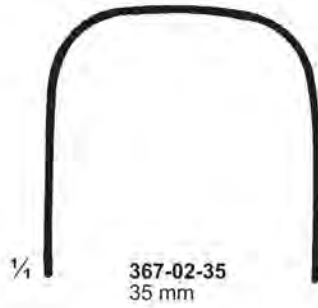
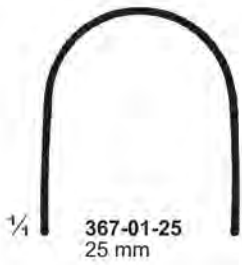

Deaver  
**367-01-25 To 367-03-50**  
32 cm / 12 $\frac{3}{4}$ "

Right  
45 mm, 1 $\frac{1}{4}$ "  
48 mm, 1 $\frac{1}{8}$ "



Cooley  
**367-04-21**  
21.5 cm / 8 $\frac{1}{2}$ "  
Atrium

Right, serrated  
45 mm, 1 $\frac{3}{4}$ "  
48 mm, 1 $\frac{1}{8}$ "



Cooley  
**367-05-21**  
21.5 cm / 8 $\frac{1}{2}$ "  
Atrium

Left  
24 mm, 1"  
48 mm, 1 $\frac{1}{8}$ "

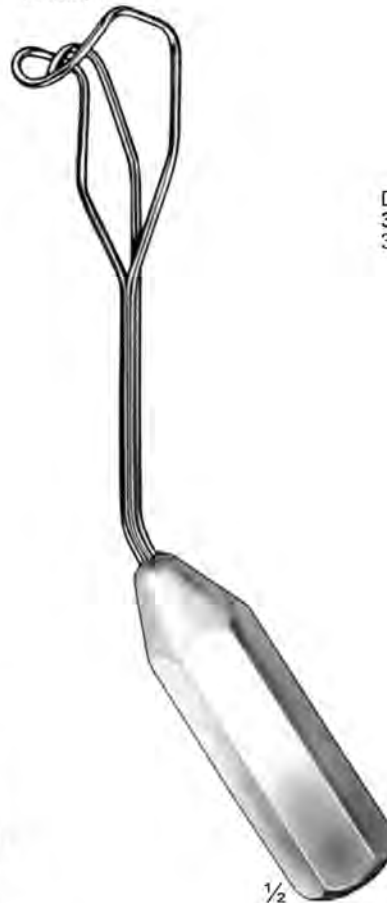

Cooley  
**367-06-23**  
23 cm / 9"  
Atrium





Holmann  
368-01-37 & 368-02-40

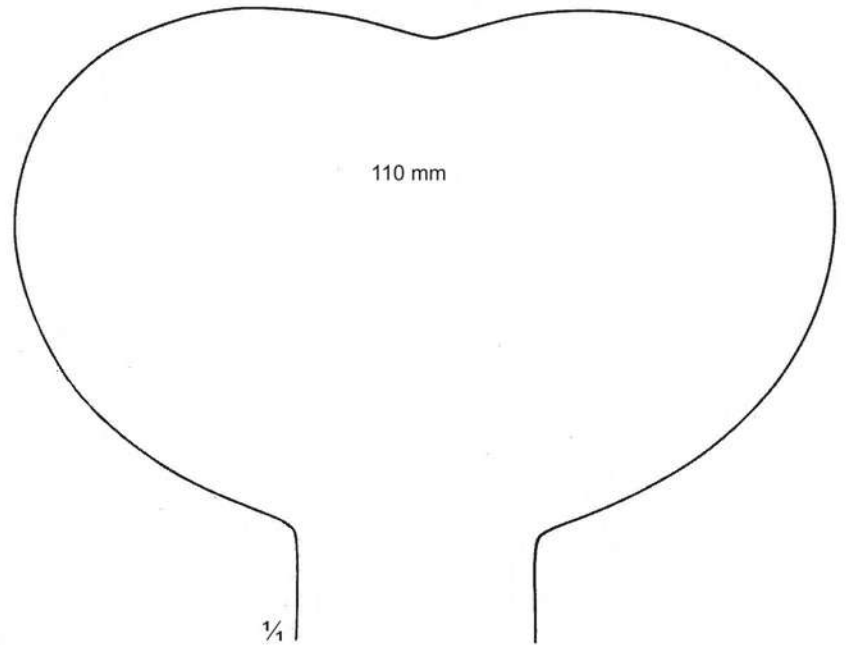

**368-02-40**  
40 cm / 16"  
Malleable,  
cooper silver-plated

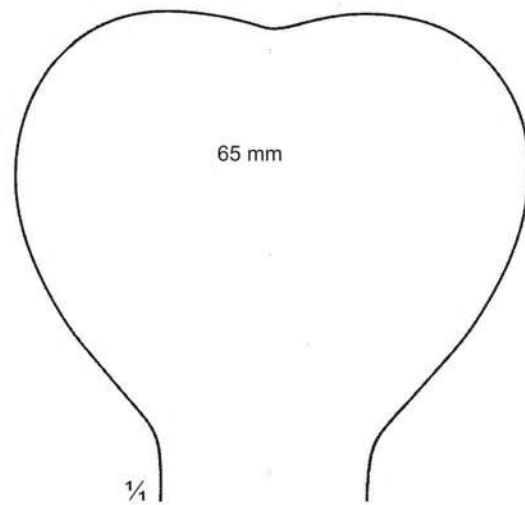

**368-01-37**  
37.5 cm / 15"  
Malleable,  
cooper silver-plated

**Wundhaken ; Separadores  
Retractors ; Divaricatori  
Ecarteurs ; Afastadores**

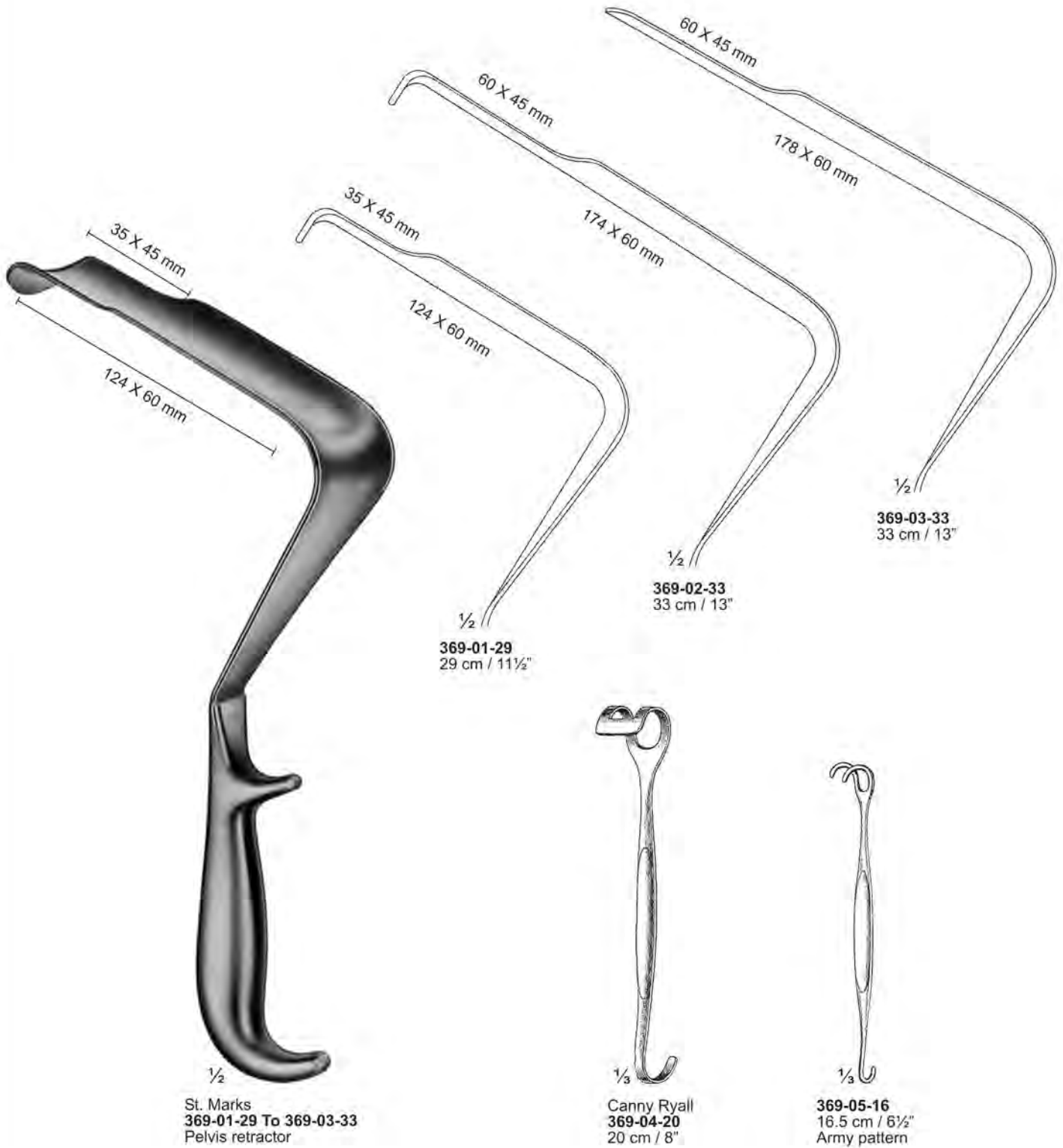

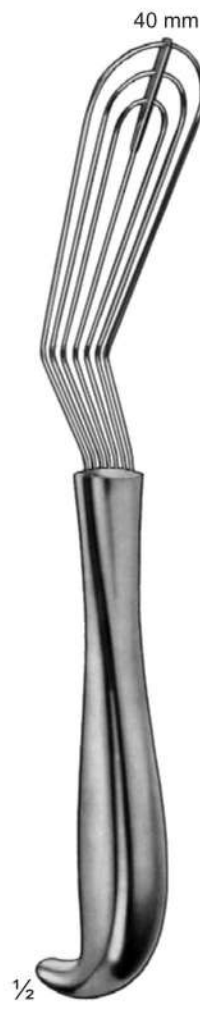
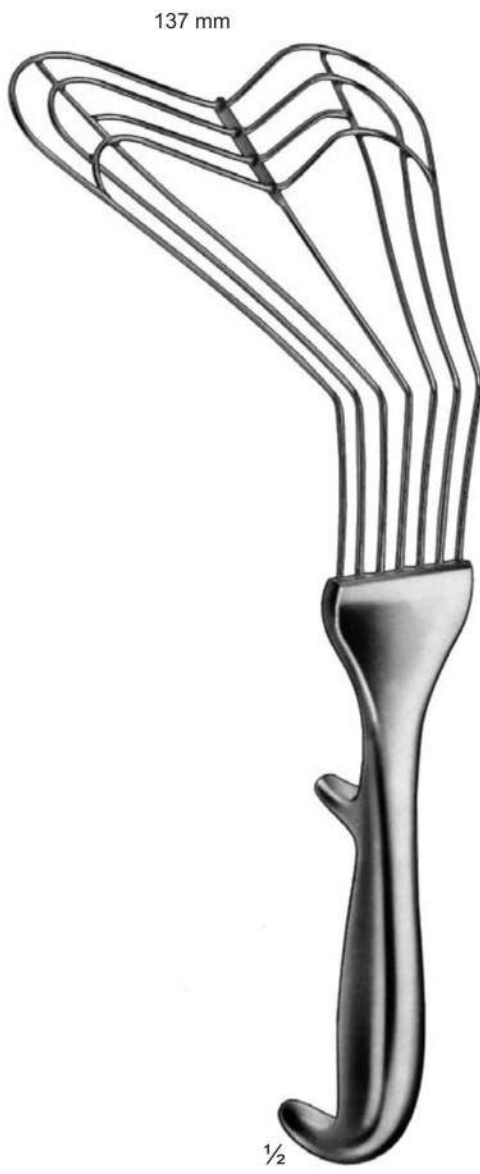

**Wundhaken ; Separadores  
Retractors ; Divaricatori  
Ecarteurs ; Afastadores**



**Koerte**  
**371-01-28**  
28 cm / 11"

**Kuettel**  
**371-02-28**  
28 cm / 11"

**Kuettel**  
**371-03-33**  
33 cm / 13"

**Kuettel**  
**371-04-28**  
28.5 cm / 11 1/4"  
Malleable



**Wundhaken ; Separadores  
Retractors ; Divaricatori  
Ecarteurs ; Afastadores**

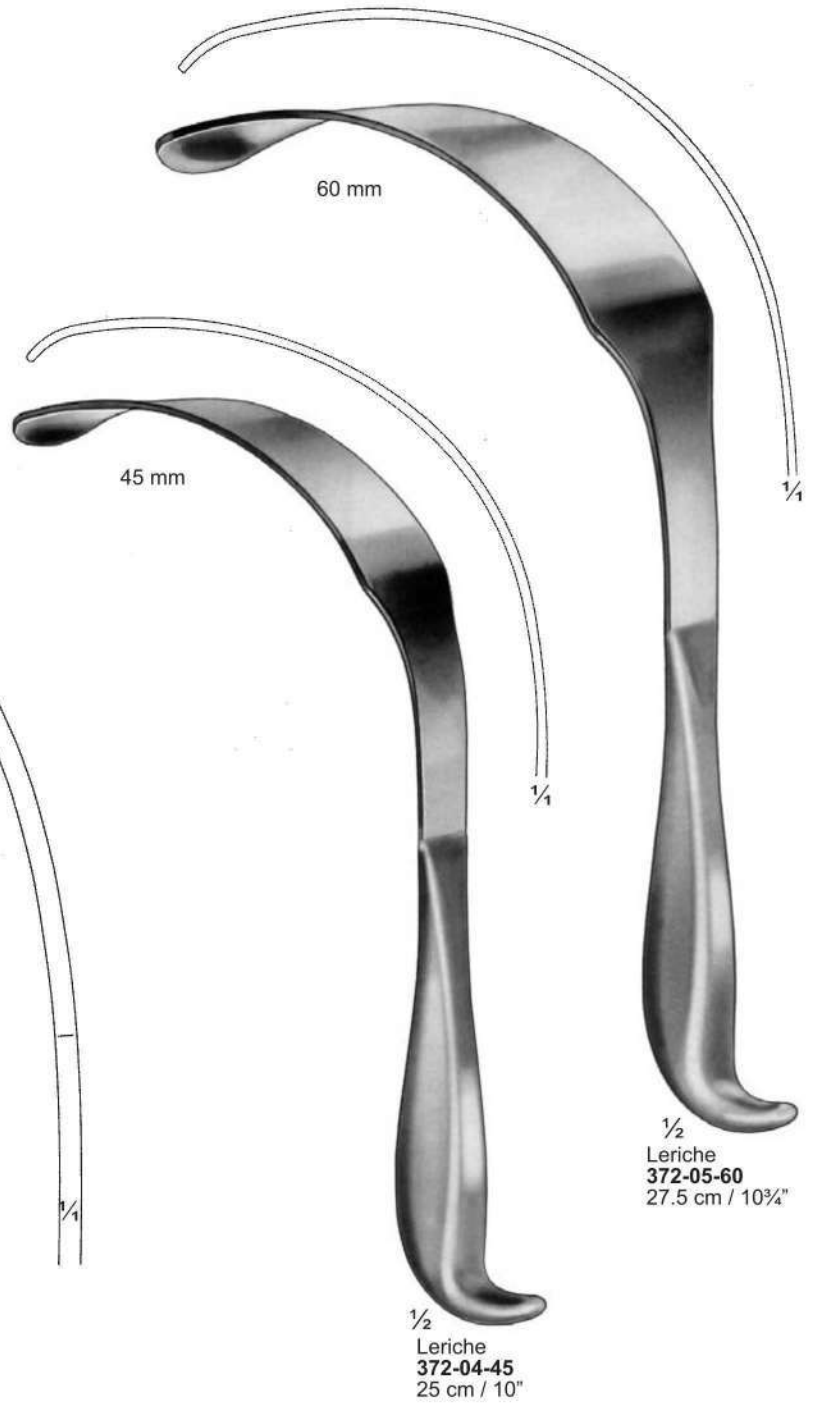
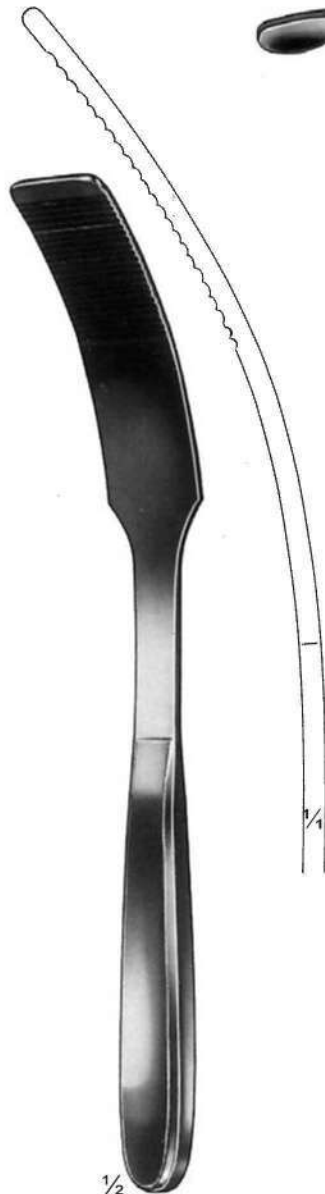
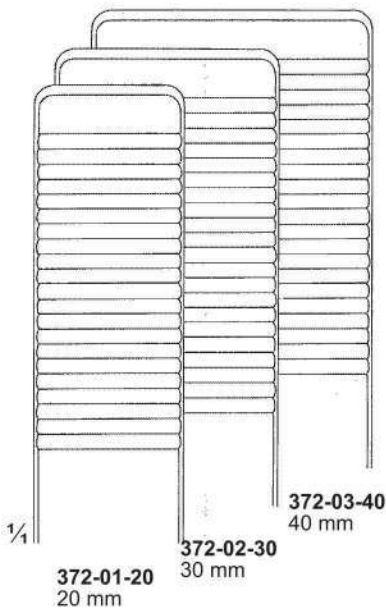

**Wundhaken ; Separadores  
Retractors ; Divaricatori  
Ecarteurs ; Afastadores**



$\frac{1}{2}$   
Mikulicz  
373-01-29  
25 cm / 10"

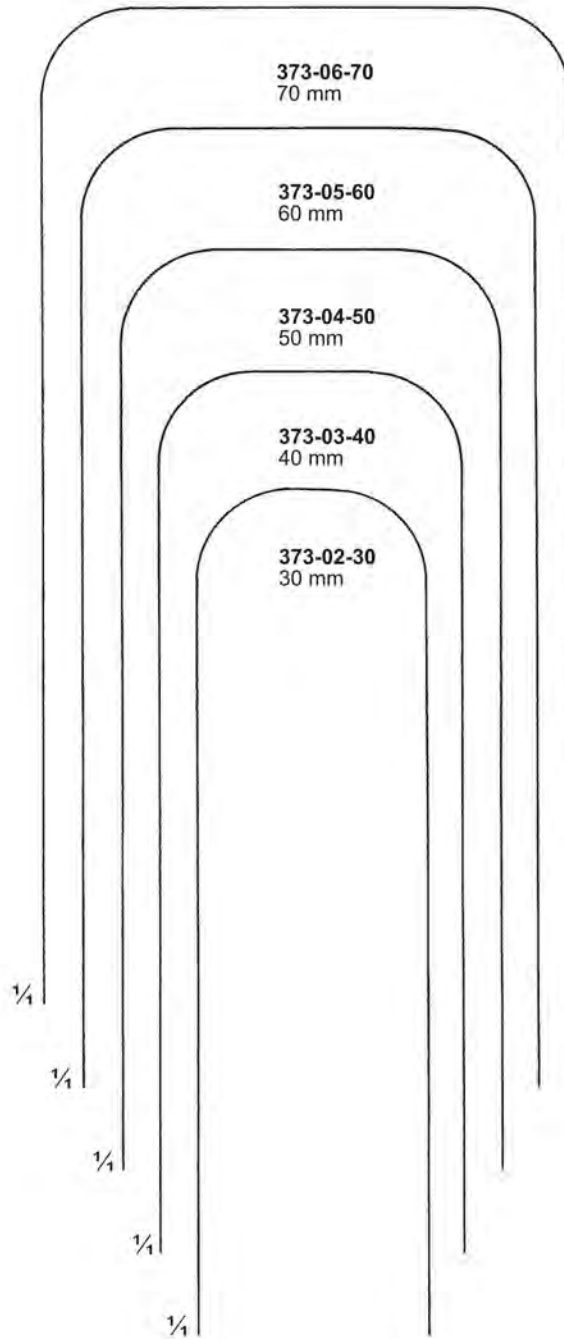

$\frac{1}{2}$   
373-02-30 To 373-06-70  
40 cm / 16"  
Malleable of cooper



**Wundhaken ; Separadores  
Retractors ; Divaricatori  
Ecarteurs ; Afastadores**

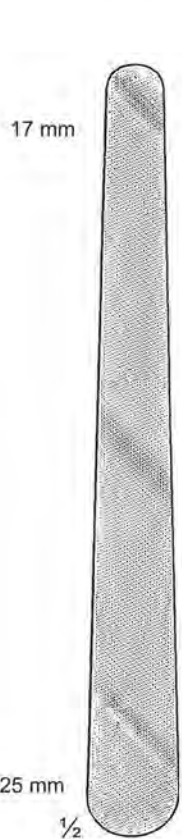

17 mm

25 mm

1/2

**Tuffier**  
**374-01-20**  
20 cm / 8"



25 mm

1/4

1/3

**374-02-33** 25 X 330 mm  
**374-03-33** 50 X 330 mm  
33 cm / 13"



28 mm

1/3

**Kocher Depressor**  
**Spoon shaped**  
**374-04-22**  
22 cm / 8 3/4"

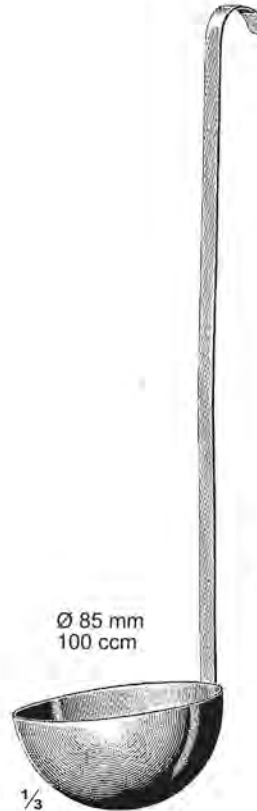

Ø 85 mm  
100 ccm

1/3

**374-05-33**  
33 cm / 13"



50 X 45 mm

1/3

**374-06-28**  
28 cm / 11"



1/3

**374-07-50**  
50 ccm

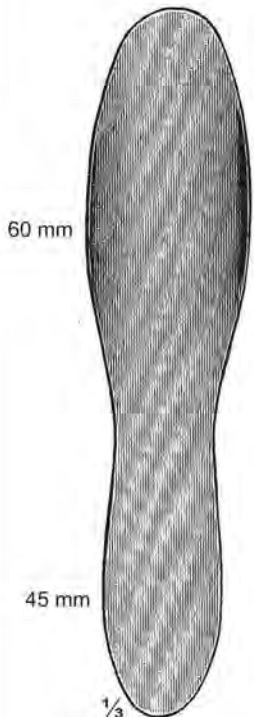

60 mm

45 mm

1/3

**Reverdin**  
**374-08-29**  
29 cm / 11 1/2"



60 mm

45 mm

1/3

**Reverdin**  
**374-09-28**  
28 cm / 11"



1/3

**374-10-12** 20 cm / 8" 12 mm  
**374-11-17** 20 cm / 8" 17 mm  
**374-12-25** 25 cm / 10" 25 mm  
Flexible



1/3

**Haberer**  
**374-13-20** 20 cm / 8" 17 X 25 mm  
**374-14-28** 28 cm / 11" 25 X 30 mm  
**374-15-30** 30 cm / 12" 37 X 45 mm



1/3

**374-16-30** 30 mm  
**374-17-40** 40 mm  
**374-18-50** 50 mm  
33 cm / 13"

**Wundhaken ; Separadores  
Retractors ; Divaricatori  
Ecarteurs ; Afastadores**



- 375-01-13 15 X 15 mm  
21 X 18 mm
- 375-02-14 22 X 20 mm  
28 X 25 mm
- 375-03-15 26 X 23 mm  
38 X 29 mm
- 375-04-16 29 X 29 mm  
44 X 34 mm

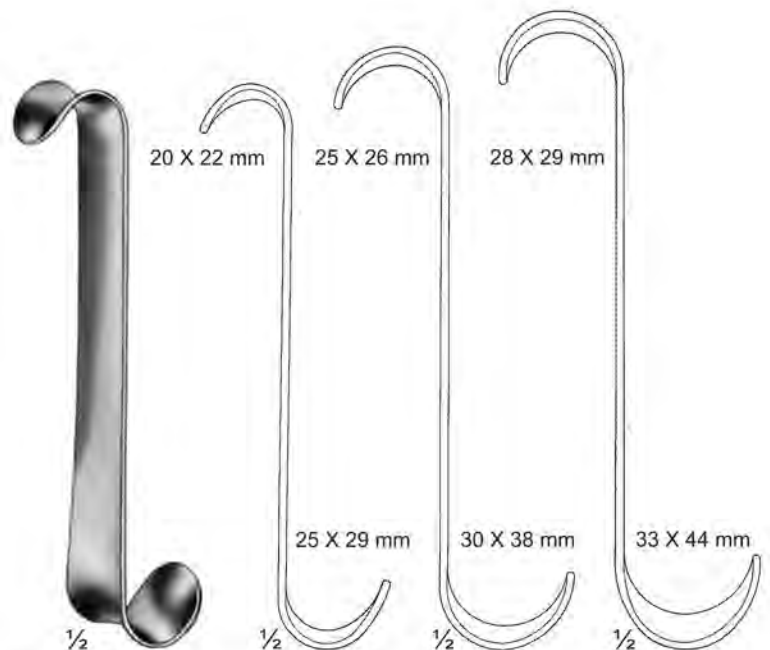

- Roux  
375-05-15 To 375-07-17
- 375-05-15 15 cm / 6"
- 375-06-16 16 cm / 6 1/4"
- 375-07-17 17 cm / 6 3/4"

- Baby-Roux**  
 375-01-13 13 cm / 5 1/8"  
 375-02-14 14 cm / 5 1/2"  
 375-03-15 15 cm / 5"  
 375-04-16 16.5 cm / 6 1/2"

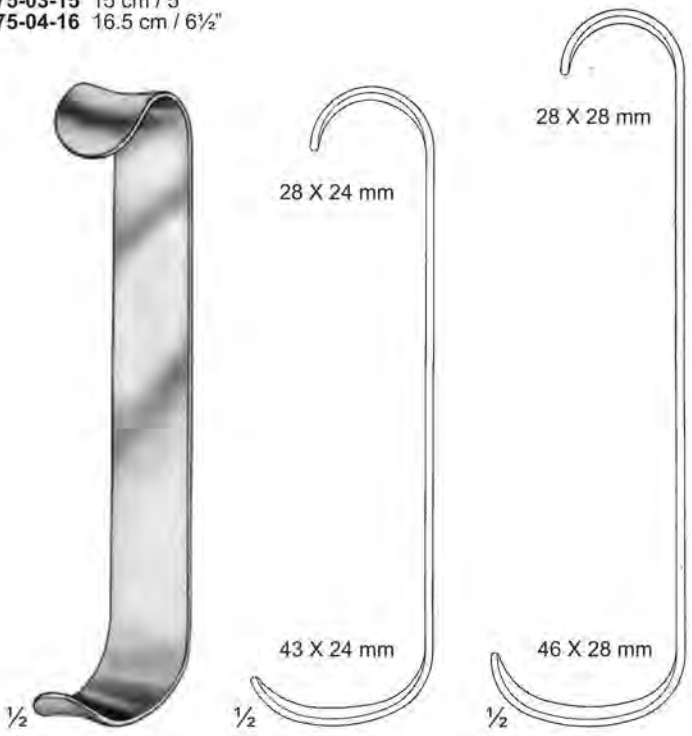

- Roux  
375-08-17 & 375-09-19
- 375-08-17 17 cm / 6 3/4"
- 375-09-19 19 cm / 7 1/2"

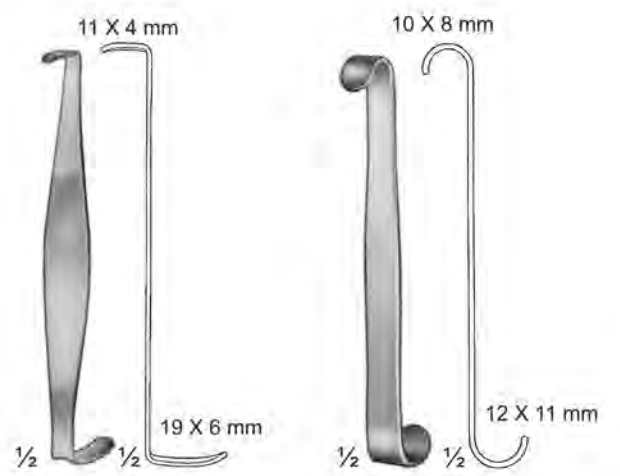

- Crile  
375-10-11 11 cm / 4 1/4"
- Luer  
375-11-11 11 cm / 4 1/4"



**Wundhaken ; Separadores  
Retractors ; Divaricatori  
Ecarteurs ; Afastadores**

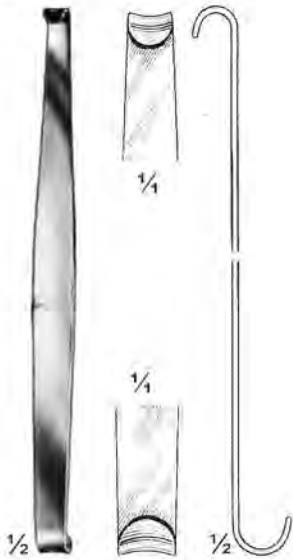

Mini Roux  
376-01-14  
14 cm / 5½"

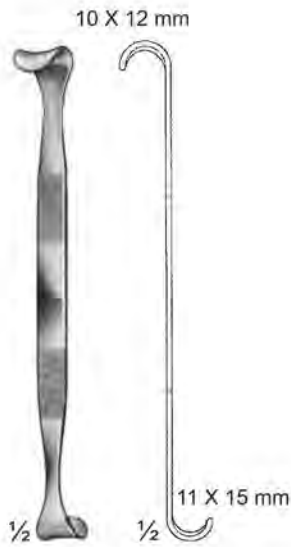

Rose  
376-02-13  
13 cm / 5½"

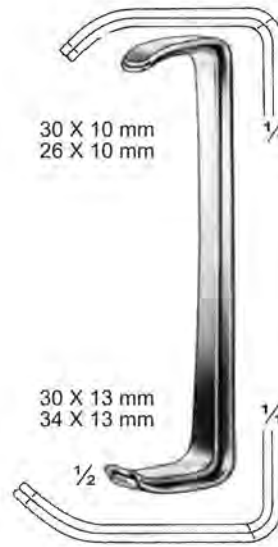

Farabeuf  
376-03-02 Set of 2  
12 cm / 4¾"

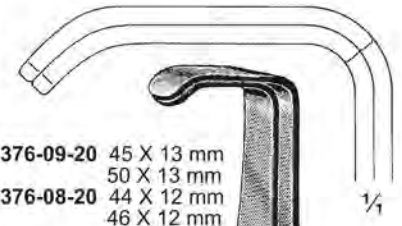

376-09-20 45 X 13 mm  
376-08-20 44 X 12 mm  
46 X 12 mm

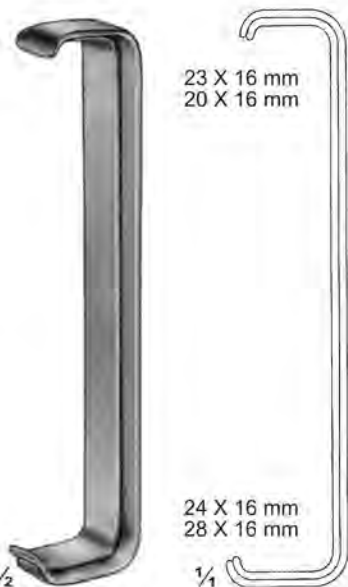

Farabeuf  
376-04-02 Set of 2  
15 cm / 6"



Both sides  
same size  
376-05-23  
15 X 20 mm  
376-06-24  
28 X 40 mm

Lane  
376-05-23 23 cm / 9"  
376-06-24 24 cm / 9½"

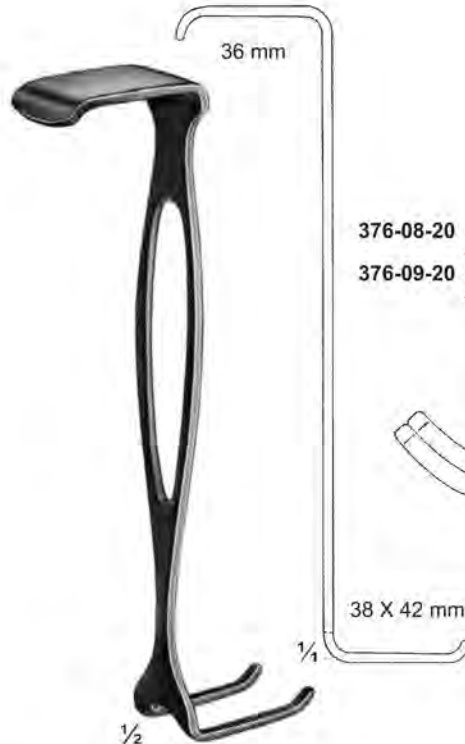

Czerny  
376-07-18  
18 cm / 7"

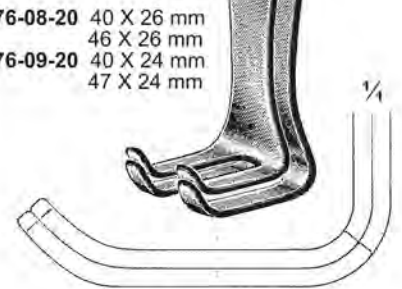

Mathieu  
376-08-20 Set of 2  
376-09-20 Set of 2  
20 cm / 8"

**Wundhaken ; Separadores  
Retractors ; Divaricatori  
Ecarteurs ; Afastadores**

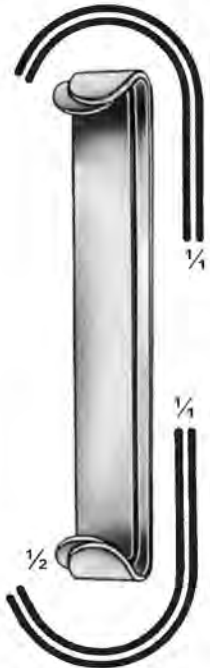

Parker  
377-01-13 Set of 2  
13 cm / 5 $\frac{1}{8}$ "



Parker  
377-02-18 Set of 2  
18 cm / 7"

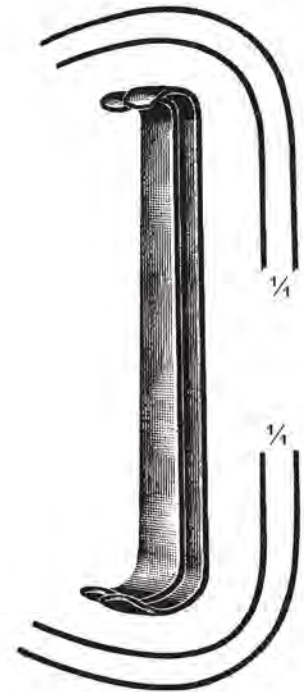

Collin  
377-03-16 Set of 2  
16.5 cm / 6 $\frac{1}{2}$ "

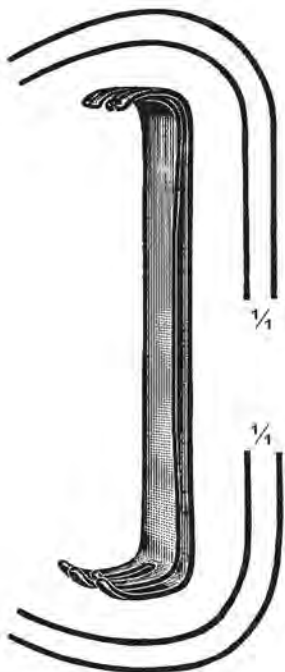

Mayo-Collin  
377-04-15 Set of 2  
15 cm / 6"

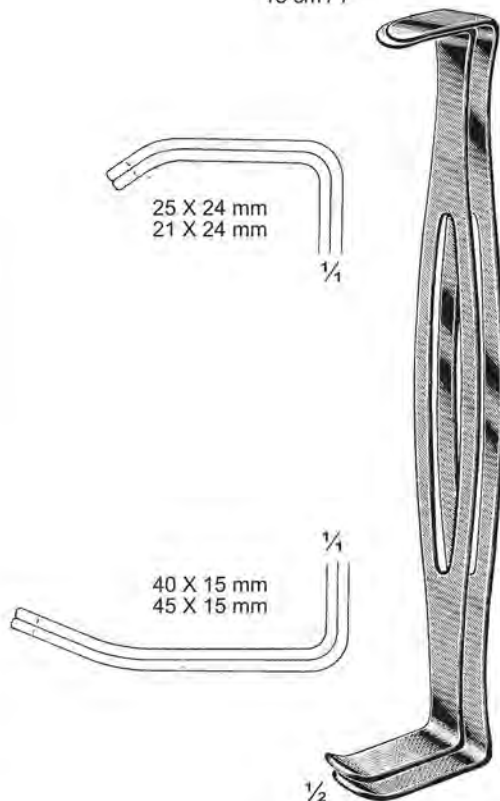

Parker-Langenbeck  
377-05-21 Set of 2  
21 cm / 8 $\frac{1}{4}$ "

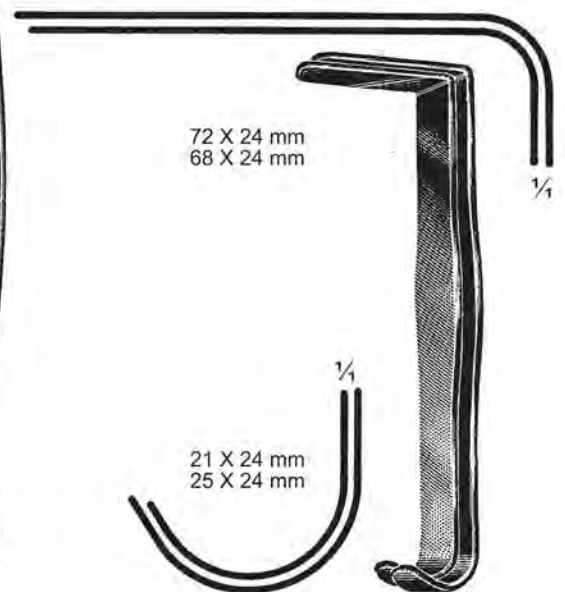

Parker-Mott  
377-06-16 Set of 2  
16.5 cm / 6 $\frac{1}{2}$ "



**Wundhaken ; Separadores  
Retractors ; Divaricatori  
Ecarteurs ; Afastadores**

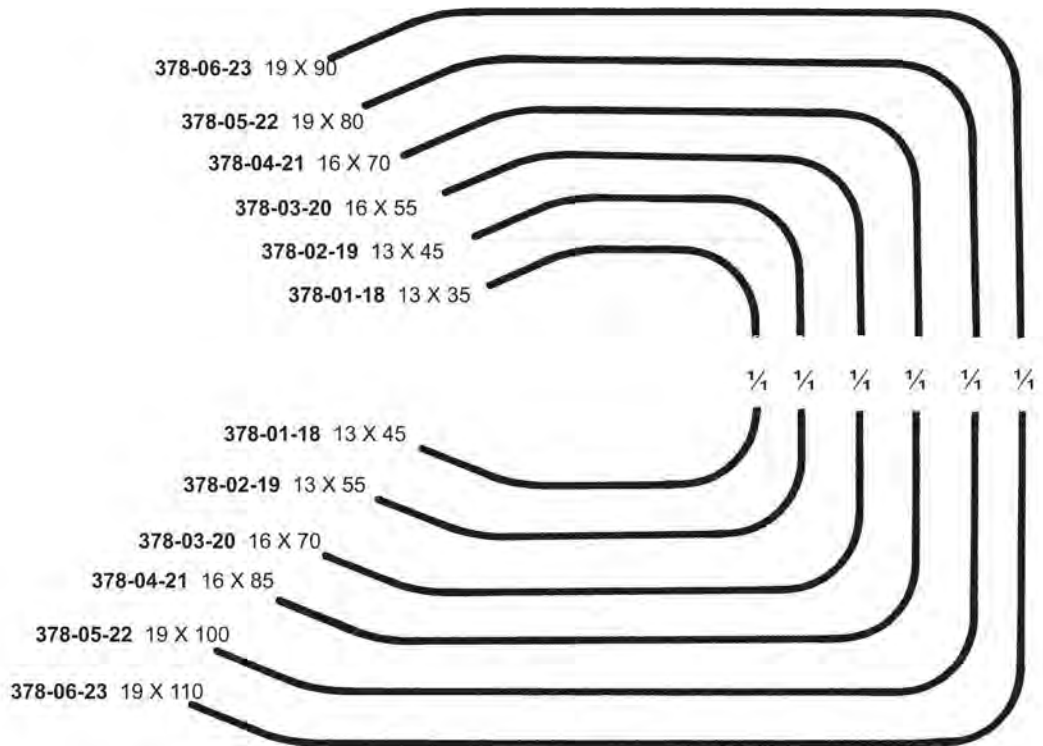

Sofield  
 378-01-18 18 cm / 7"  
 378-02-19 19 cm / 7½"  
 378-03-20 20 cm / 8"  
 378-04-21 21 cm / 8¼"  
 378-05-22 22 cm / 8¾"  
 378-06-23 23 cm / 9"

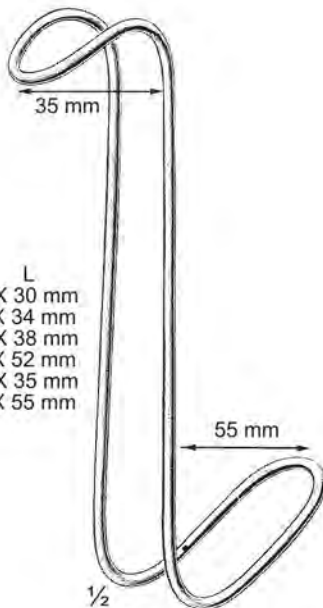

	W	L
378-07-14	21 X 30 mm	
	26 X 34 mm	
378-08-16	30 X 38 mm	
	33 X 52 mm	
378-09-16	25 X 35 mm	
	38 X 55 mm	

Collin-Hartmann  
 378-07-14 14 cm / 5½"  
 378-08-16 16 cm / 6¼"  
 378-09-16 16 cm / 6¼"

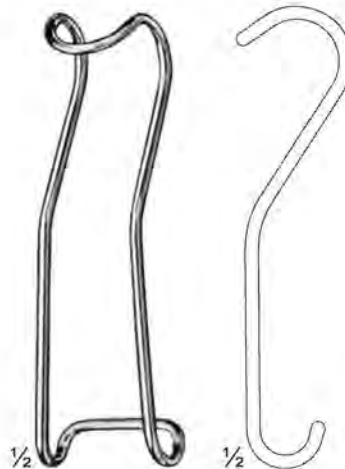

Sternberg  
 378-10-12 12 cm / 4¾"  
 378-11-13 13 cm / 5⅛"  
 378-12-13 13.5 cm / 5¼"



Sofield  
 378-13-06  
 Set of 6 (378-01 To 378-06)

**Wundhaken ; Separadores  
Retractors ; Divaricatori  
Ecarteurs ; Afastadores**

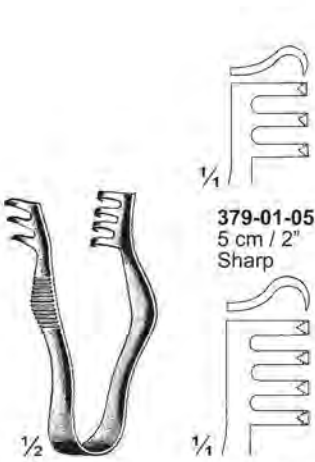

**379-01-05**  
5 cm / 2"  
Sharp



**379-02-05**  
5 cm / 2"  
Blunt

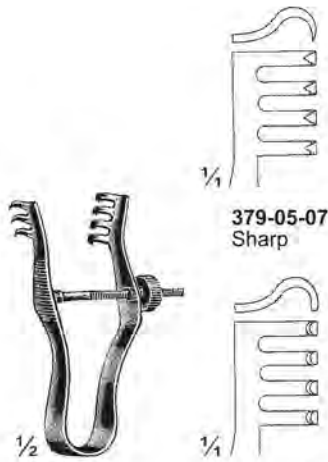

**379-05-07**  
Sharp



Finsen  
**379-07-07**  
7.5 cm / 3"  
Blunt



Agricola  
**379-08-04**  
4 cm / 1 1/2"  
Sharp

Finsen  
**379-01-05 To 379-04-07**

**379-03-07**  
7 cm / 2 3/4"  
Sharp

**379-04-07**  
7 cm / 2 3/4"  
Blunt

Finsen  
**379-05-07 & 379-06-07**  
7 cm / 2 3/4"

**379-06-07**  
Blunt

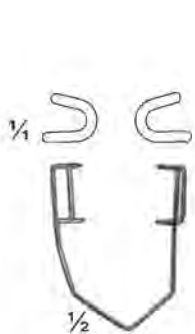

Barraquer  
**379-09-04**  
4.5 cm / 1 3/4"  
Blunt



**379-10-04**  
4.5 cm / 1 3/4"  
Blunt



**379-11-05**  
5.5 cm / 2 1/8"  
Blunt



Bosc  
**379-12-06**  
6 cm / 2 1/4"  
Blunt

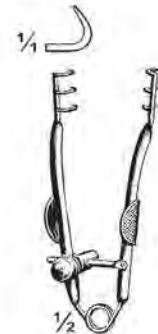

Buckley  
**379-13-07**  
7 cm / 2 3/4"  
Sharp

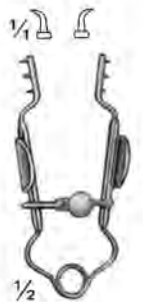

Mueller  
**379-14-06**  
6.5 cm / 2 1/2"  
Sharp

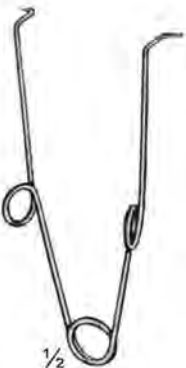

**379-15-08** 8 cm / 3 1/4"  
**379-16-11** 11.5 cm / 4 1/2"  
Sharp

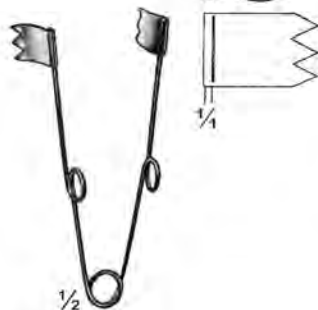

**379-17-08**  
8 cm / 3 1/4"  
Sharp



**379-18-10**  
10.5 cm / 4 1/8"  
Sharp

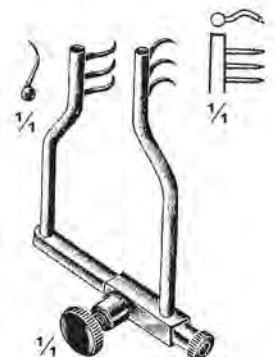

Logan  
**379-19-04**  
4 cm Opening  
Sharp

**Wundhaken ; Separadores  
Retractors ; Divaricatori  
Ecarteurs ; Afastadores**



Sauer  
380-01-03  
3.5 cm / 1 1/8"



Lancaster  
380-02-08  
8 cm / 3 1/4"

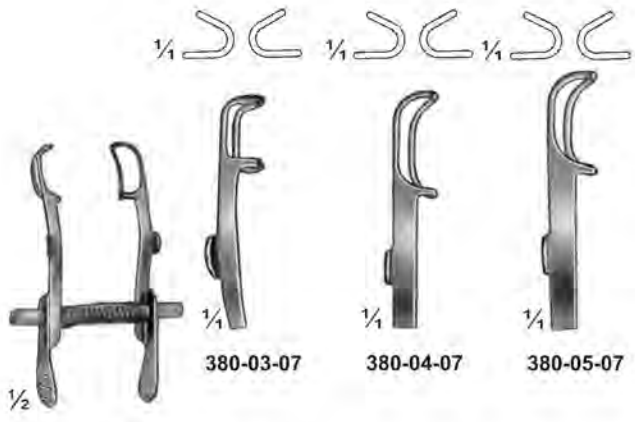

Mellinger  
380-03-07 To 380-05-07  
7 cm / 2 3/4"



Allport  
380-06-09  
9.5 cm / 3 3/4"



Aim  
380-07-07 To 380-11-10

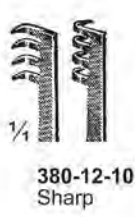
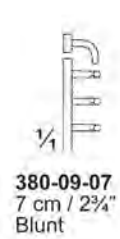
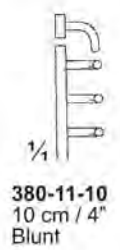
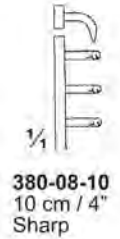
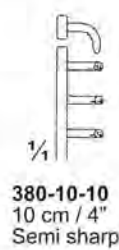
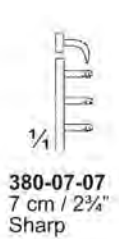

380-12-10 & 380-13-10  
10 cm / 4"



Kuttner  
380-14-24  
24 cm / 9 1/2"  
Wound stretcher

**Wundhaken ; Separadores  
Retractors ; Divaricatori  
Ecarteurs ; Afastadores**



**Stevenson**  
**381-01-07**  
7.5 cm / 3"  
Sharp



**Jansen**  
**381-02-10 To 381-04-10**  
10 cm / 4"

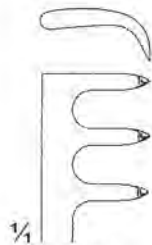

$\frac{1}{4}$   
**381-02-10**  
Sharp

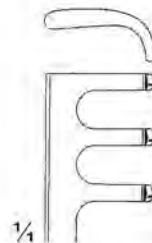

$\frac{1}{4}$   
**381-04-10**  
Blunt

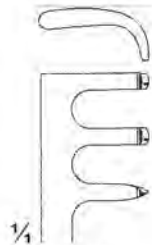

$\frac{1}{4}$   
**381-03-10**  
1 Sharp and  
2 blunt prongs



$\frac{1}{2}$   
**Wagner-Jansen**  
**381-05-11**  
11 cm / 4 $\frac{1}{4}$ "



$\frac{1}{2}$   
**Jansen**  
**381-06-10**  
10 cm / 4"



**Gifford-Jansen**  
**381-07-10**  
10 cm / 4"  
Sharp



**381-08-11**  
11 cm / 4 $\frac{1}{4}$ "



**Shambaugh**  
**381-09-11**  
11 cm / 4 $\frac{1}{4}$ "

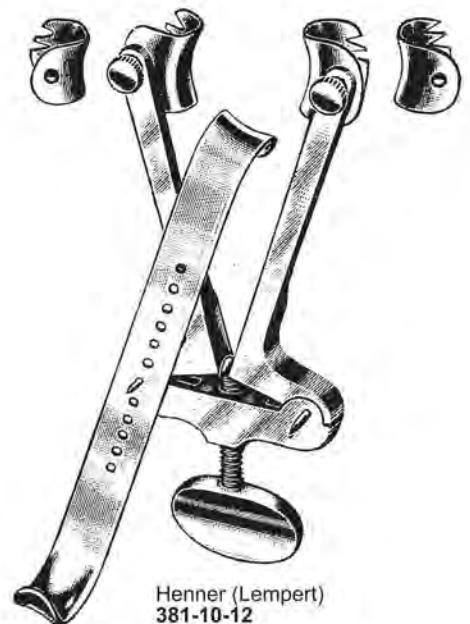

**Henner (Lempert)**  
**381-10-12**  
12 cm / 4 $\frac{3}{4}$ "

**Wundhaken ; Separadores  
Retractors ; Divaricatori  
Ecarteurs ; Afastadores**

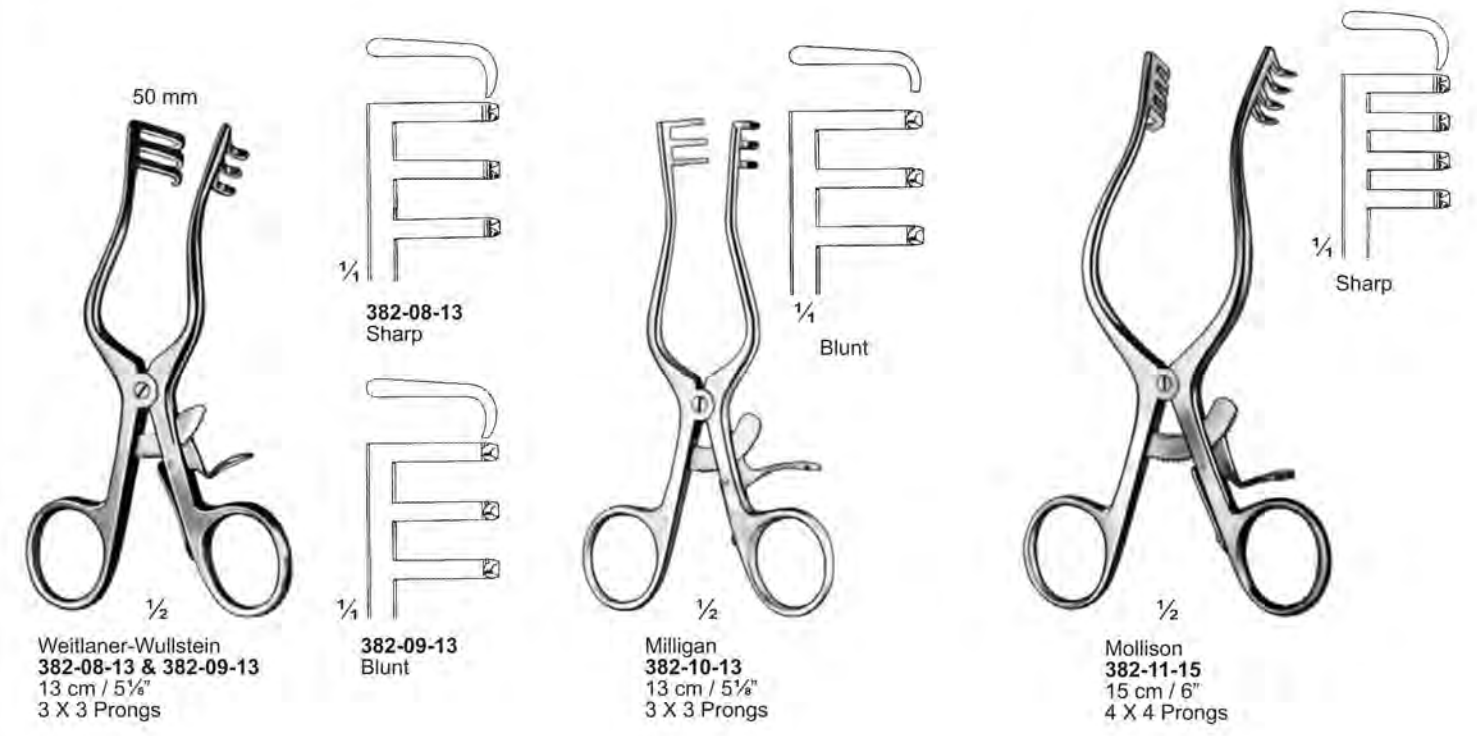
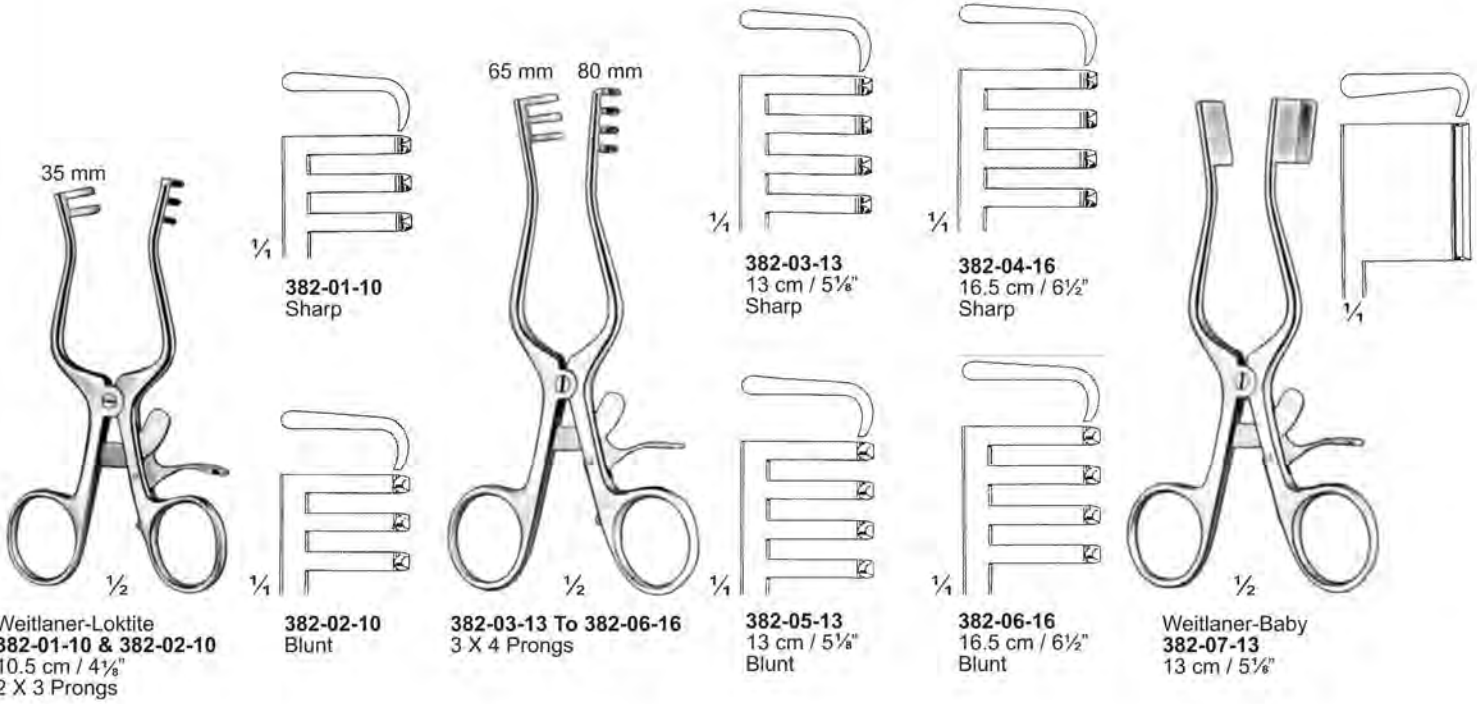

**Wundhaken ; Separadores  
Retractors ; Divaricatori  
Ecarteurs ; Afastadores**



Weitlaner  
**383-01-13** 13 cm / 5 1/8"  
**383-02-16** 16.5 cm / 6 1/2"  
3 X 4 Prongs  
Semi sharp



Weitlaner-Original  
**383-03-10** Sharp  
**383-04-10** Blunt  
10.5 cm / 4 1/8"  
2 X 3 Prongs



Weitlaner-Original  
**383-05-13** 13 cm / 5 1/8" Sharp  
**383-06-13** 13 cm / 5 1/8" Blunt  
**383-07-16** 16.5 cm / 6 1/2" Sharp  
**383-08-16** 16.5 cm / 6 1/2" Blunt  
3 X 4 Prongs

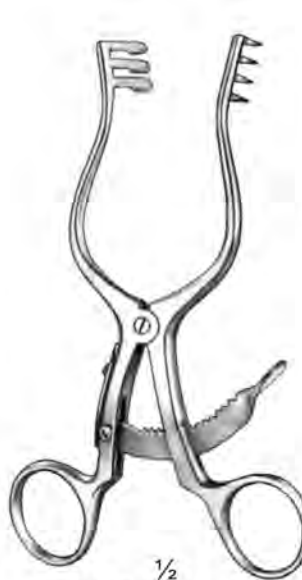

Scalp Contour  
**383-09-14 & 383-10-14**  
14 cm / 5 1/2"  
3 X 4 Prongs

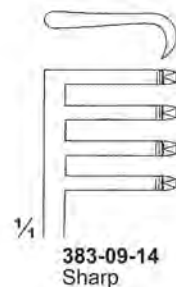

**383-09-14**  
Sharp

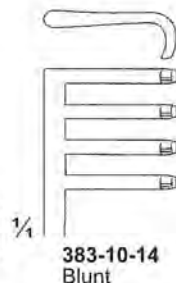

**383-10-14**  
Blunt



Plester  
**383-11-11**  
11 cm / 4 1/4"  
Blunt



Plester  
**383-12-11**  
11 cm / 4 1/4"  
Blunt



Plester  
**383-13-13**  
13 cm / 5 1/8"  
2 X 2 Prongs  
Sharp

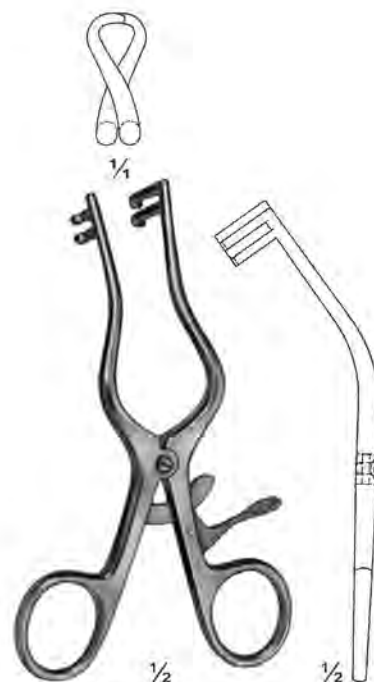

Plester  
**383-14-13**  
13 cm / 5 1/8"  
2 X 2 Prongs  
Blunt



**Wundhaken ; Separadores  
Retractors ; Divaricatori  
Ecarteurs ; Afastadores**



Perkins  
**384-01-13**  
13 cm / 5 1/8"



Perkins  
**384-02-13**  
13 cm / 5 1/8"



Bellucci  
**384-03-13**  
13 cm / 5 1/8"  
3 X 3 Prongs  
Sharp

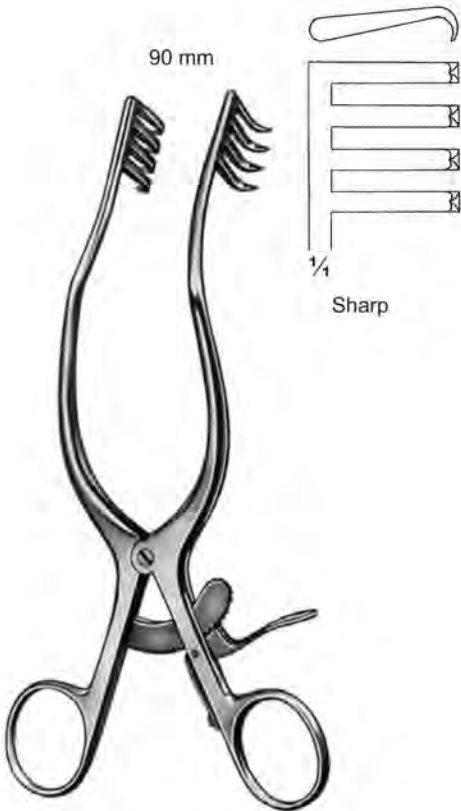

Anderson-Adson  
**384-04-20**  
20 cm / 8"  
4 X 4 Prongs



Weitlaner  
**384-05-20 & 384-06-20**  
20 cm / 8"  
3 X 4 Prongs

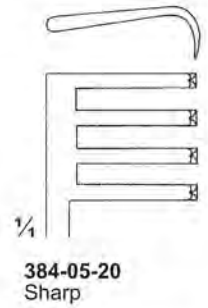

**384-05-20**  
Sharp

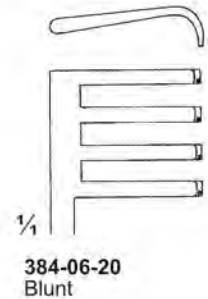

**384-06-20**  
Blunt

**Wundhaken ; Separadores  
Retractors ; Divaricatori  
Ecarteurs ; Afastadores**



Cloward  
**385-01-16**  
16.5 cm / 6½"  
Blunt



Cloward  
**385-02-16**  
16.5 cm / 6½"  
3 X 3 Prongs  
Blunt

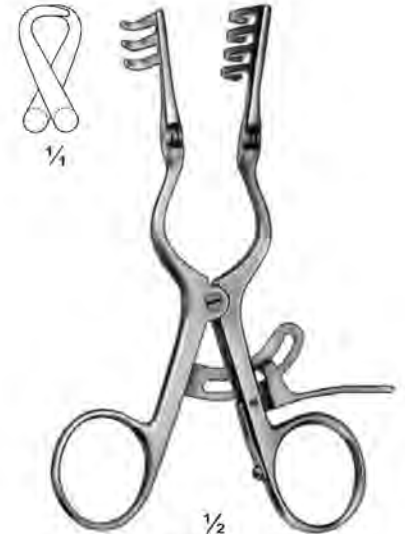

Adson-Baby  
**385-03-14**  
14 cm / 5½"  
3 X 4 Prongs  
Blunt

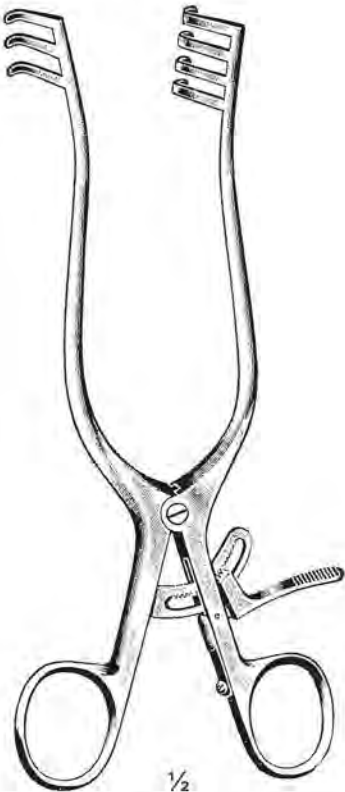

Weitlaner  
**385-04-20 To 385-09-25**

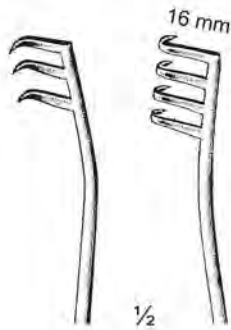

**385-04-20**  
20 cm / 8"  
3 X 4 Prongs  
Sharp

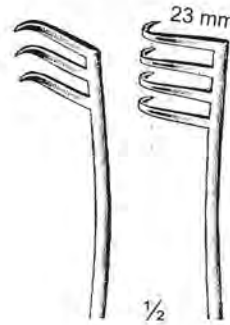

**385-05-25**  
25 cm / 10"  
3 X 4 Prongs  
Sharp

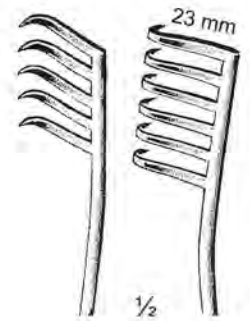

**385-06-25**  
25 cm / 10"  
5 X 6 Prongs  
Sharp



**385-07-20**  
20 cm / 8"  
3 X 4 Prongs  
Blunt



**385-08-25**  
25 cm / 10"  
3 X 4 Prongs  
Blunt

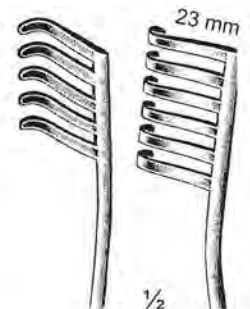

**385-09-25**  
25 cm / 10"  
5 X 6 Prongs  
Blunt

**Wundhaken ; Separadores  
Retractors ; Divaricatori  
Ecarteurs ; Afastadores**

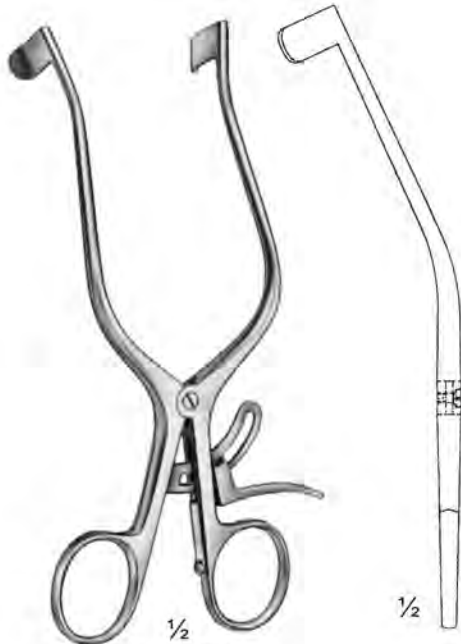
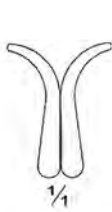

Tübinger Mod.  
**386-01-16**  
16.5 cm / 6½"

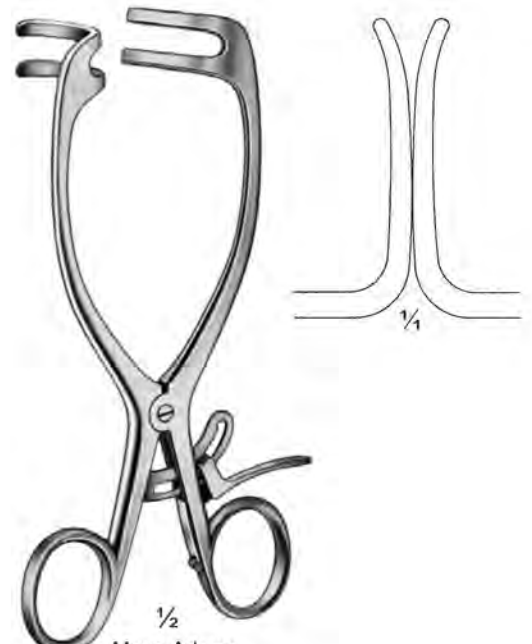

Mayo-Adams  
**386-02-16**  
16.5 cm / 6½"



Adson  
**386-03-26 To 386-06-26**  
26.5 cm / 10½"

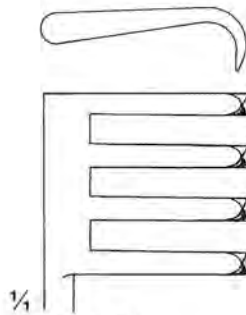

**386-03-26**  
3 X 4 Prongs  
Sharp

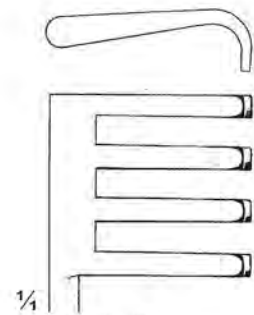

**386-04-26**  
3 X 4 Prongs  
Blunt

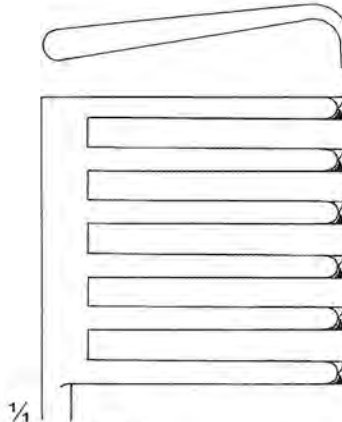

**386-05-26**  
6 X 6 Prongs  
Sharp

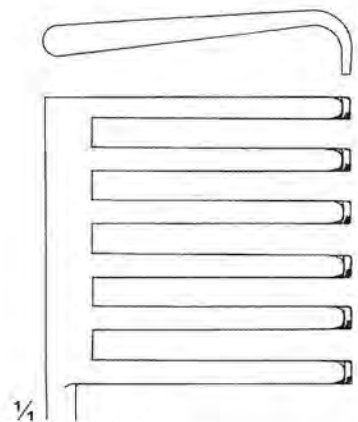

**386-06-26**  
6 X 6 Prongs  
Blunt



**Wundhaken ; Separadores  
Retractors ; Divaricatori  
Ecarteurs ; Afastadores**

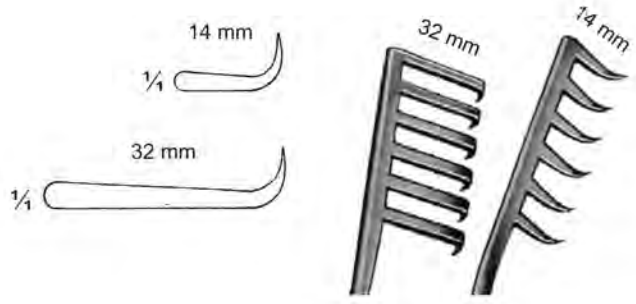

Adson  
**387-07-26**  
26.5 cm / 10½"  
6 X 6 Prongs  
Sharp

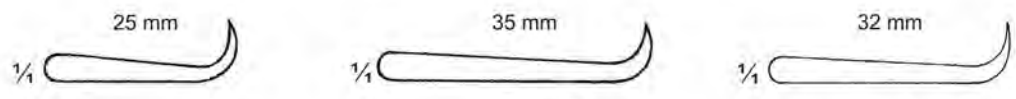

Adson  
**387-01-26 Sharp**  
**387-02-26 Blunt**  
26.5 cm / 10½"  
3 X 4 Prongs

Adson  
**387-03-26 Sharp**  
**387-04-26 Blunt**  
26.5 cm / 10½"  
5 X 6 Prongs

Adson  
**387-05-26**  
26.5 cm / 10½"  
6 X 6 Prongs  
Sharp

Adson  
**387-06-26**  
26.5 cm / 10½"  
6 X 6 Prongs  
Sharp

**Wundhaken ; Separadores  
Retractors ; Divaricatori  
Ecarteurs ; Afastadores**



1/2  
Miskimon  
388-01-22 Sharp  
388-02-22 Blunt  
22 cm / 8 3/4"  
7 X 7 Prongs



1/2  
Henley  
388-03-16 & 388-04-16  
16.5 cm / 6 1/2"  
With central blade

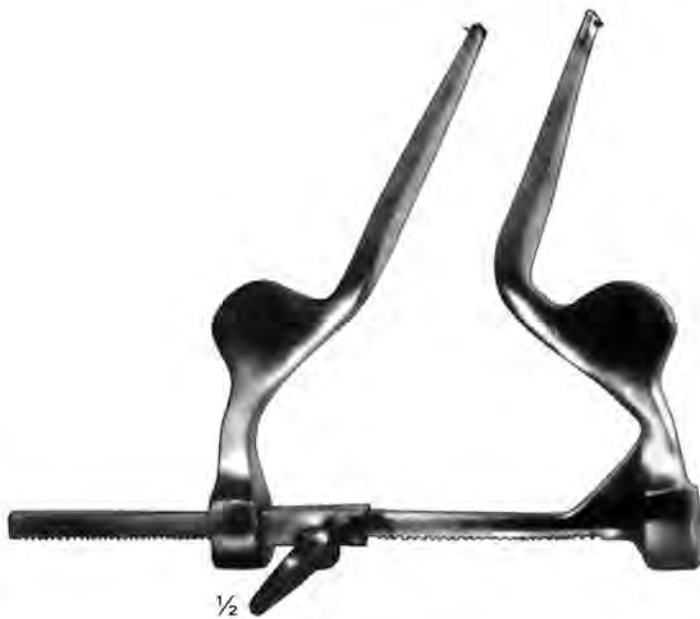
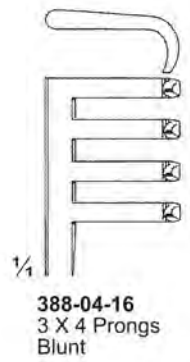
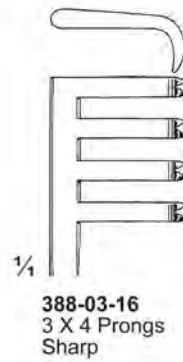

1/2  
Cloward  
388-05-18  
18 cm / 7" Opening



1/2  
Cloward  
388-06-16 16 cm / 6 1/4"  
388-07-18 18 cm / 7"  
388-08-23 23 cm / 9"

**Wundhaken ; Separadores  
Retractors ; Divaricatori  
Ecarteurs ; Afastadores**



Adson  
389-01-13 To 389-08-26  
3 X 4 Prongs

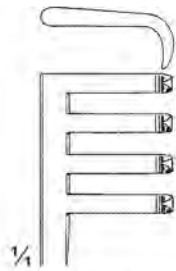

**389-01-13**  
13 cm / 5 1/8"  
Sharp

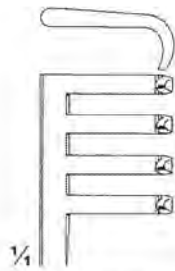

**389-02-13**  
13 cm / 5 1/8"  
Blunt

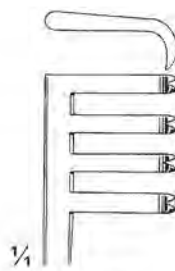

**389-03-16**  
16 cm / 6 1/4"  
Sharp

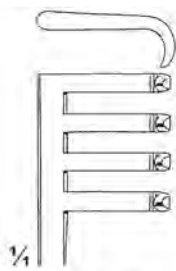

**389-04-16**  
16 cm / 6 1/4"  
Blunt

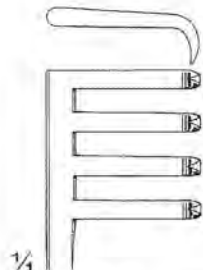

**389-05-20**  
20 cm / 8"  
Sharp

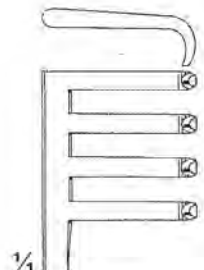

**389-06-20**  
20 cm / 8"  
Blunt

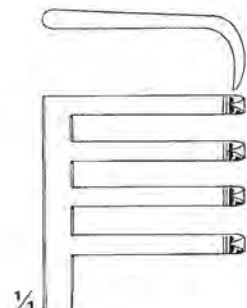

**389-07-26**  
26 cm / 10 1/4"  
Sharp

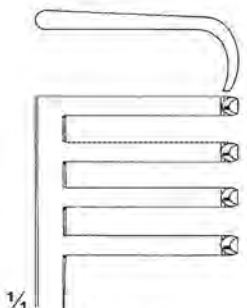

**389-08-26**  
26 cm / 10 1/4"  
Blunt

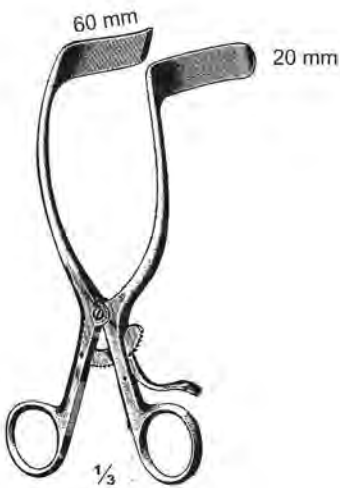

Rugby  
**389-09-18**  
18 cm / 7"

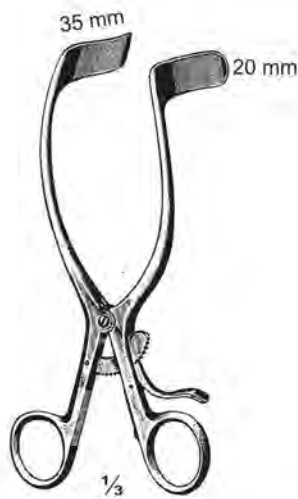

**389-10-18**  
18 cm / 7"

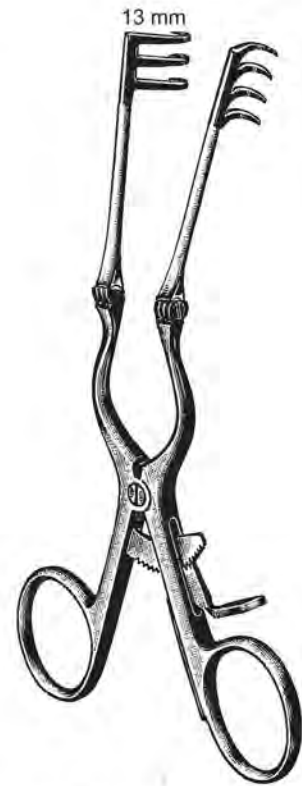

Weitlaner-Beckmann  
**389-11-16** 16.5 cm / 6 1/2" Sharp  
**389-12-16** 16.5 cm / 6 1/2" Blunt  
**389-13-20** 20 cm / 8" Sharp  
**389-14-20** 20 cm / 8" Blunt  
3 X 4 Prongs

**Wundhaken ; Separadores  
Retractors ; Divaricatori  
Ecarteurs ; Afastadores**



1/2  
Beckmann  
390-01-31  
31 cm / 12 1/4"  
4 X 4 Prongs  
Sharp



1/2  
Beckmann-Eaton  
390-02-32  
32 cm / 12 1/2"  
7 X 7 Prongs  
Semi-Sharp



1/2  
Adson  
390-03-32  
32 cm / 12 1/2"  
4 X 5 Prongs  
Blunt

**Wundhaken ; Separadores  
Retractors ; Divaricatori  
Ecarteurs ; Afastadores**

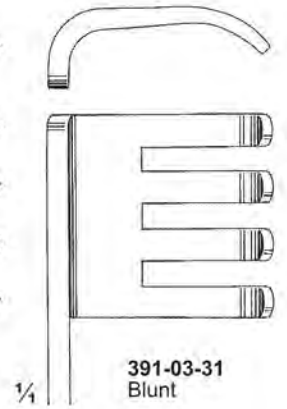
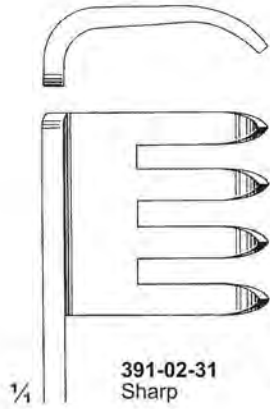
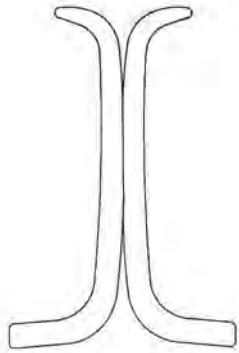

**Harvey Jackson**  
391-01-28  
28 cm / 11"  
3 X 3 Prongs  
Sharp



**Beckmann-Adson**  
391-02-31 To 391-05-31  
31 cm / 12¼"  
4 X 4 Prongs

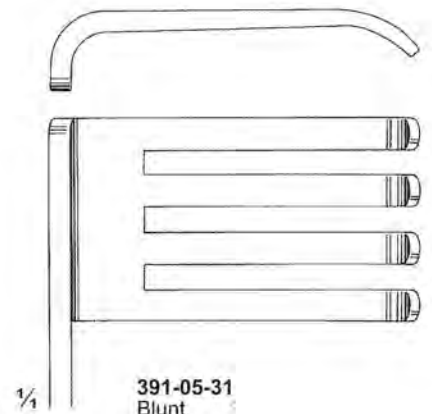
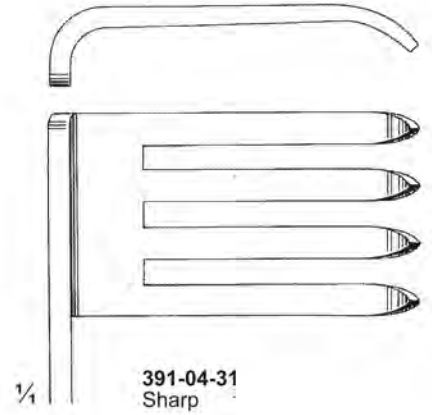



Wundhaken ; Separadores  
 Retractors ; Divaricatori  
 Ecarteurs ; Afastadores



392-03-16



Beckmann-Bayonet  
 392-01-26 Sharp  
 392-02-26 Blunt  
 26 cm / 10¼"  
 4 X 4 Prongs

¼  
 Courty-Fontaine  
 392-03-16  
 16 cm / 6¼"  
 3 X 4 Prongs  
 392-04-16  
 16.5 cm / 6½"  
 4 X 5 Prongs

¼  
 Courty  
 392-05-11  
 11.5 cm / 4½"

**Wundhaken ; Separadores  
Retractors ; Divaricatori  
Ecarteurs ; Afastadores**



Sexton  
393-03-32  
32 cm / 12½"  
Horizontal retractor  
2 X 4 Prongs

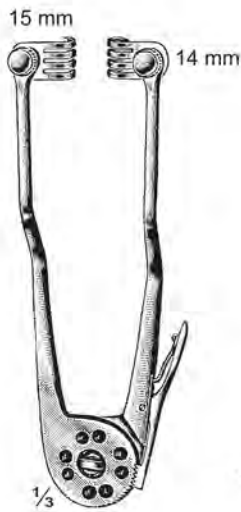

Crotti  
393-01-18  
18.5 cm / 7¼"  
4 X 4 Prongs



1/2  
Charnley  
393-04-28  
28 cm / 11"  
Horizontal retractor



Kocher  
393-02-16  
16 cm / 6¼"  
4 X 4 Prongs

**Wundhaken ; Separadores  
Retractors ; Divaricatori  
Ecarteurs ; Afastadores**



Markham-Meyerding  
394-01-18  
18 cm / 7"



Markham-Meyerding  
394-02-18  
18 cm / 7"



Meyerding  
394-03-19 44 X 25 mm  
394-04-19 54 X 25 mm  
394-05-19 60 X 19 mm  
394-06-19 60 X 25 mm  
19 cm / 7½"



Knighton  
394-07-18  
18 cm / 7"



Knighton  
394-08-18  
18 cm / 7"

**Wundhaken ; Separadores  
Retractors ; Divaricatori  
Ecarteurs ; Afastadores**



**Darling**  
**395-01-18**  
18 cm / 7"



**Darling**  
**395-02-18**  
18 cm / 7"

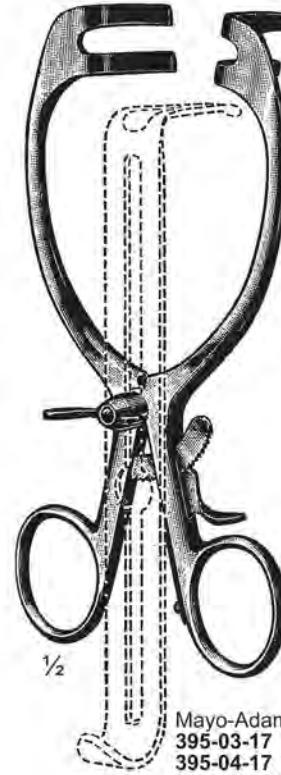

**Mayo-Adams**  
**395-03-17** With central blade  
**395-04-17** Without central blade  
17 cm / 6 3/4"

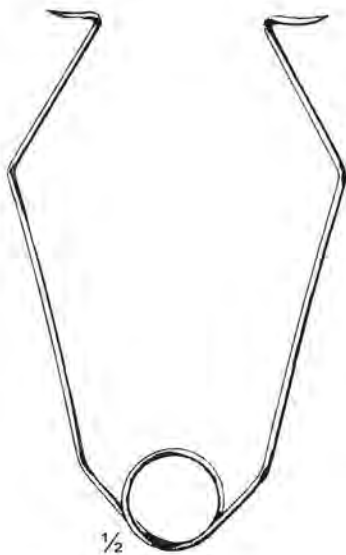

**Mayo-Adams**  
**395-05-16**  
16.5 cm / 6 1/2"

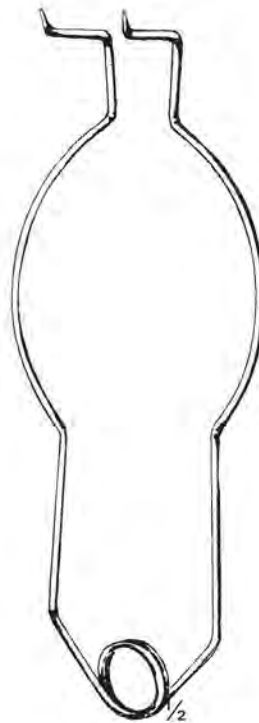

**Farr**  
**395-06-14** 19 mm  
**395-07-14** 28 mm  
14 cm / 5 1/2"



**Farr**  
**395-08-23** 22 mm  
23 cm / 9"

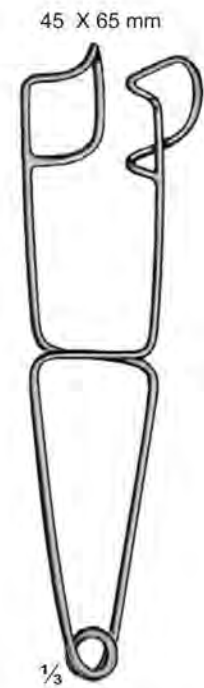

**Dartigues**  
**395-09-24**  
24 cm / 9 1/2"

**Wundhaken ; Separadores  
Retractors ; Divaricatori  
Ecarteurs ; Afastadores**

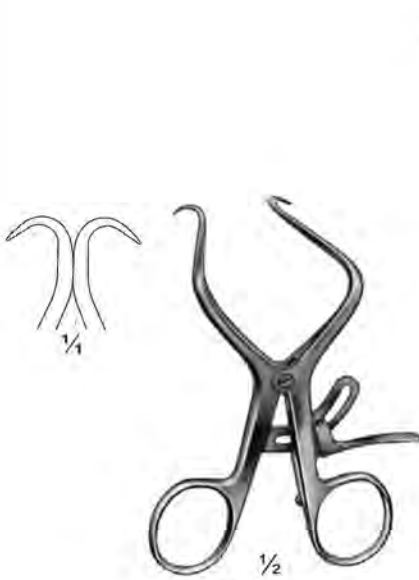

De Bakey  
396-01-10  
10 cm / 4"



De Bakey  
396-02-14  
14.5 cm / 5 3/4"



Gelpi-Baby  
396-03-13  
13 cm / 5 1/8"

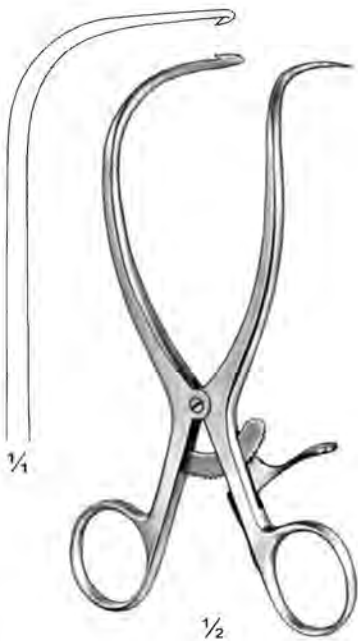

Gelpi-Seiletz  
396-04-15  
15 cm / 6"

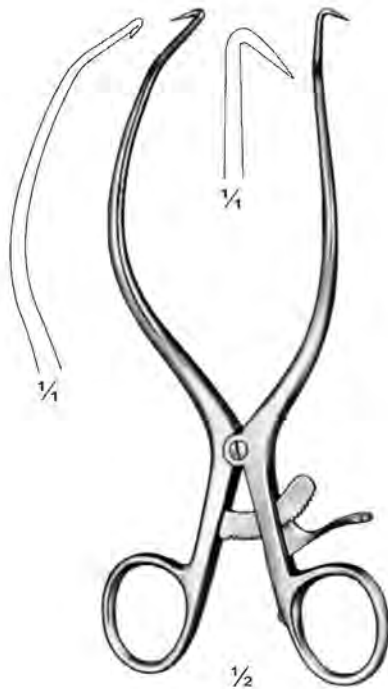

Gelpi-Loktite  
396-05-18  
18 cm / 7"

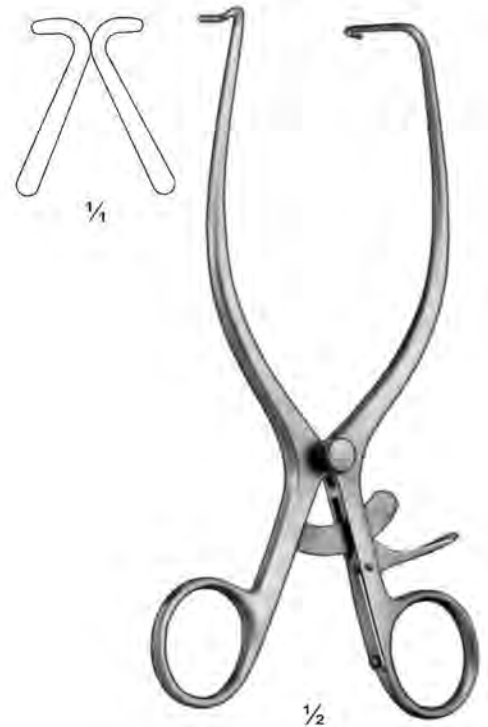

Jackson Burrows  
396-06-18  
18.5 cm / 7 1/4"

**Wundhaken ; Separadores  
Retractors ; Divaricatori  
Ecarteurs ; Afastadores**



Gelpi  
397-01-18  
18 cm / 7"

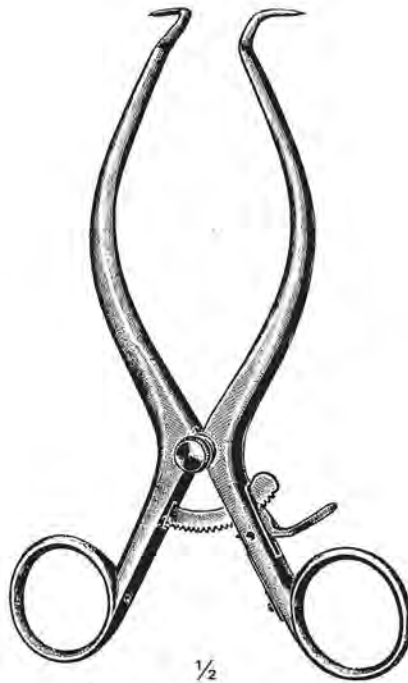

Gelpi  
397-02-16 16.5 cm / 6½"  
397-03-18 18 cm / 7"  
397-04-19 19 cm / 7½"  
Strong model

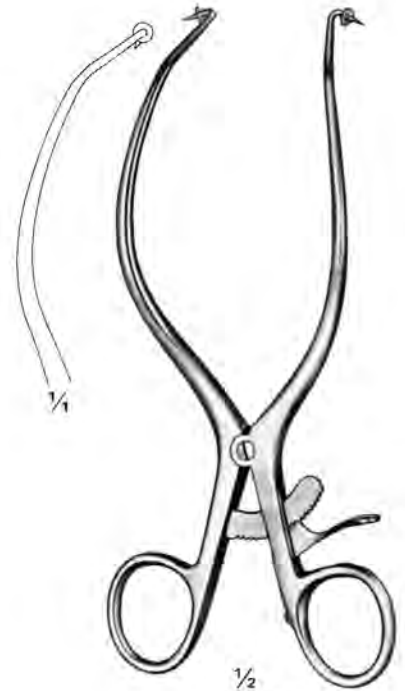

Gelpi-Loktite  
397-05-18  
18 cm / 7"

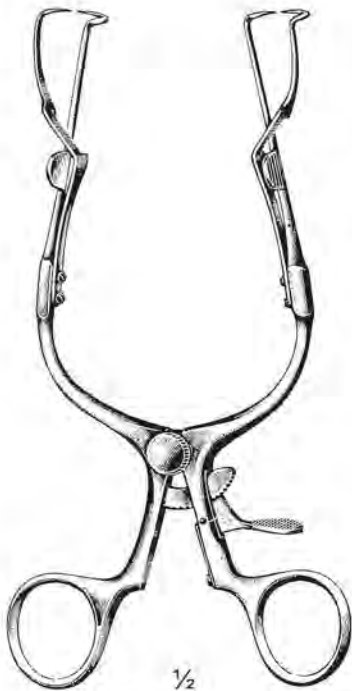

Richter  
397-06-16 16.5 cm / 6½"  
397-07-18 18 cm / 7"  
397-08-20 20 cm / 8"



Joll (Friedman)  
397-09-15  
15 cm / 6"

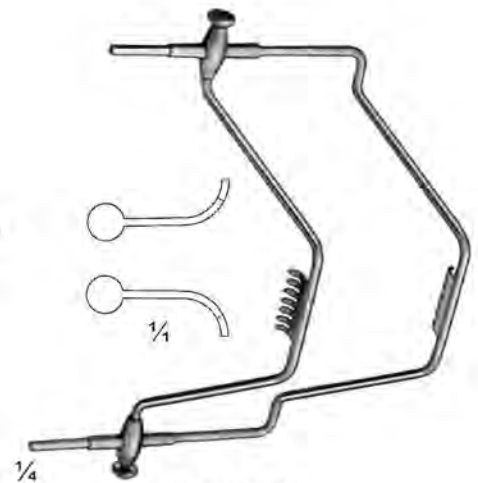

397-10-00

**Wundhaken ; Separadores  
Retractors ; Divaricatori  
Ecarteurs ; Afastadores**



110 mm  
1/2  
Cloward modif.  
398-01-25 To 398-10-25  
25 cm / 10"



1/2  
398-01-25  
16 X 40 mm



1/2  
398-02-25  
16 X 45 mm



1/2  
398-03-25  
16 X 50 mm



1/2  
398-04-25  
16 X 55 mm



1/2  
398-05-25  
16 X 60 mm



1/2  
398-06-25  
16 X 40 mm



1/2  
398-07-25  
16 X 45 mm



1/2  
398-08-25  
16 X 50 mm



1/2  
398-09-25  
16 X 55 mm



1/2  
398-10-25  
16 X 60 mm



398-11-17  
40 X 14 mm



398-12-17  
46 X 14 mm



398-13-17  
50 X 14 mm



398-14-17  
55 X 14 mm



398-15-17  
60 X 14 mm



Cloward  
398-11-17 To 398-15-17  
17 cm / 6 1/4"

**Wundhaken ; Separadores  
Retractors ; Divaricatori  
Ecarteurs ; Afastadores**



$\frac{1}{2}$   
**399-01-13**  
13 cm / 5 $\frac{1}{4}$ "



$\frac{1}{2}$   
Knighton  
**399-02-19**  
19 cm / 7 $\frac{1}{2}$ "



$\frac{1}{2}$   
Knighton  
**399-03-19**  
19 cm / 7 $\frac{1}{2}$ "



$\frac{1}{2}$   
Cloward  
**399-04-16**  
16 cm / 6 $\frac{1}{4}$ "

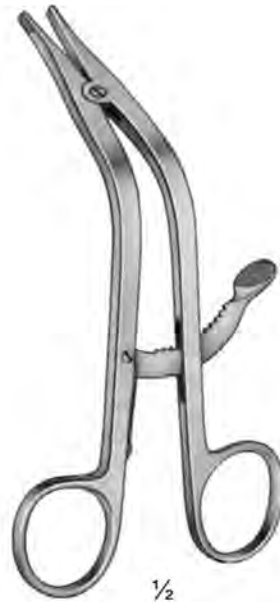

$\frac{1}{2}$   
Cloward  
**399-05-15**  
15 cm / 6"



$\frac{1}{2}$   
Cloward  
**399-06-13**  
13.5 cm / 5 $\frac{1}{4}$ "



**Wundhaken ; Separadores  
Retractors ; Divaricatori  
Ecarteurs ; Afastadores**

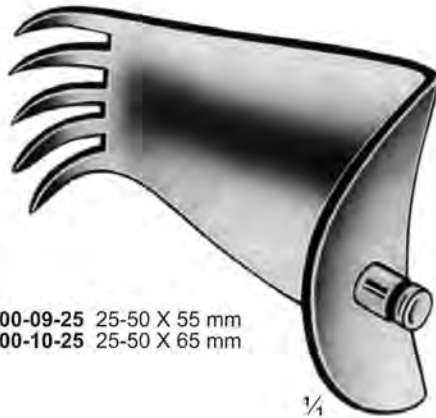

400-09-25 25-50 X 55 mm  
400-10-25 25-50 X 65 mm

1/4



Cloward-Hoehn  
400-09-25 & 400-10  
25 cm / 10"

1/2



Hoehn  
400-01-27 To 400-04-27  
27 cm / 10 3/4"



400-01-27 45 X 35 mm 400-05-23  
400-02-27 45 X 45 mm 400-06-23

1/4



400-03-27 25 X 35 mm 400-07-23  
400-04-27 25 X 45 mm 400-08-23

1/4



Cloward-Lumber  
400-05-23 To 400-08-23  
23 cm / 9"

1/2

**Wundhaken ; Separadores  
Retractors ; Divaricatori  
Ecarteurs ; Afastadores**

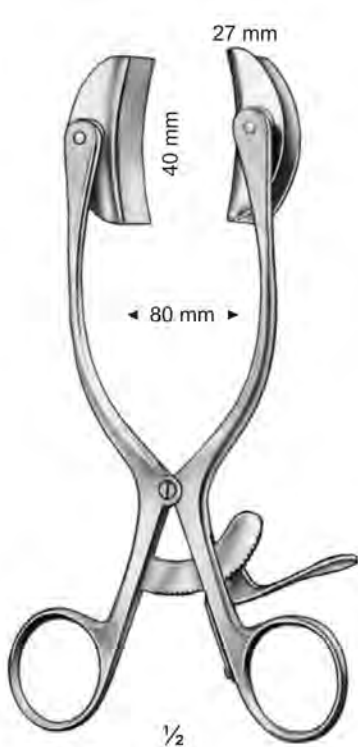

Baby-Collin  
401-01-17  
17 cm / 6 3/4"  
Abdominal retractor complete  
with 2 pairs of blades

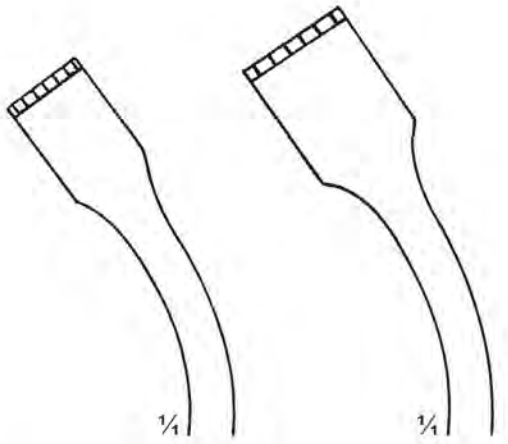
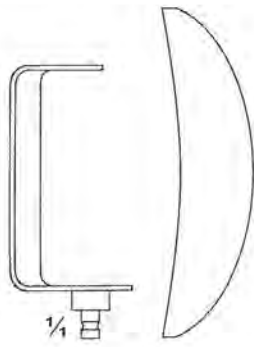

401-03-26  
5 mm

401-04-26  
10 mm

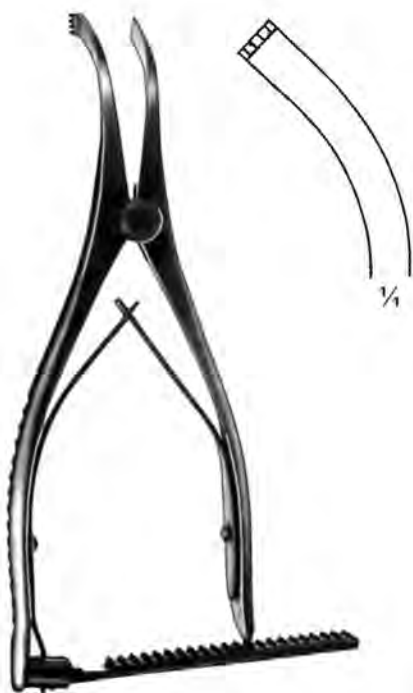

Inge  
401-02-16  
16 cm / 6 1/4"



Inge  
401-03-26 & 401-04-26  
26 cm / 10 1/4"

**Wundhaken ; Separadores  
Retractors ; Divaricatori  
Ecarteurs ; Afastadores**



Collin  
**402-01-13**  
22 cm / 8<sup>3</sup>/<sub>4</sub>"



Collin	Opening	Lateral Blades	Central Blade
<b>402-02-13</b>	135 mm	37 X 62 mm	54 X 55 mm
<b>402-03-16</b>	160 mm	37 X 80 mm	54 X 67 mm
<b>402-04-16</b>	160 mm	37 X 98 mm	52 X 76 mm

22 cm / 8<sup>3</sup>/<sub>4</sub>"



Collin-Loktite  
**402-05-16**  
26 cm / 10<sup>1</sup>/<sub>4</sub>"

**Wundhaken ; Separadores  
Retractors ; Divaricatori  
Ecarteurs ; Afastadores**

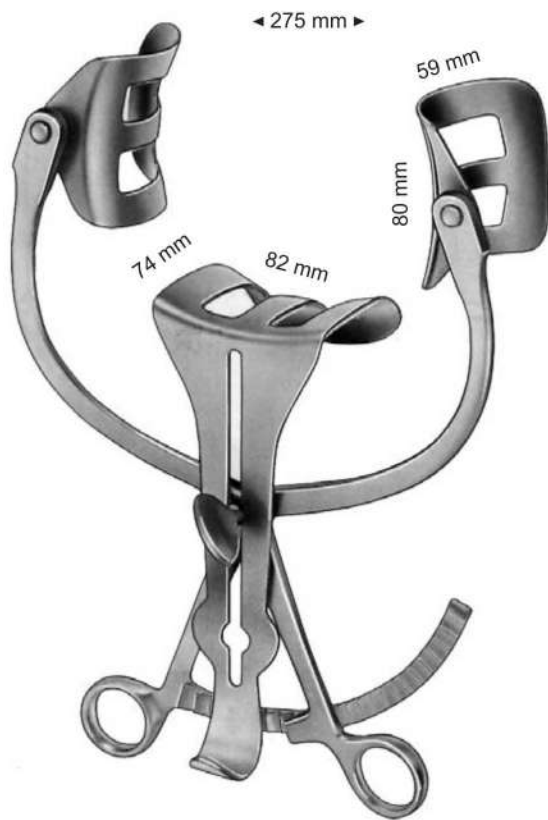

Holzbach  
403-01-27

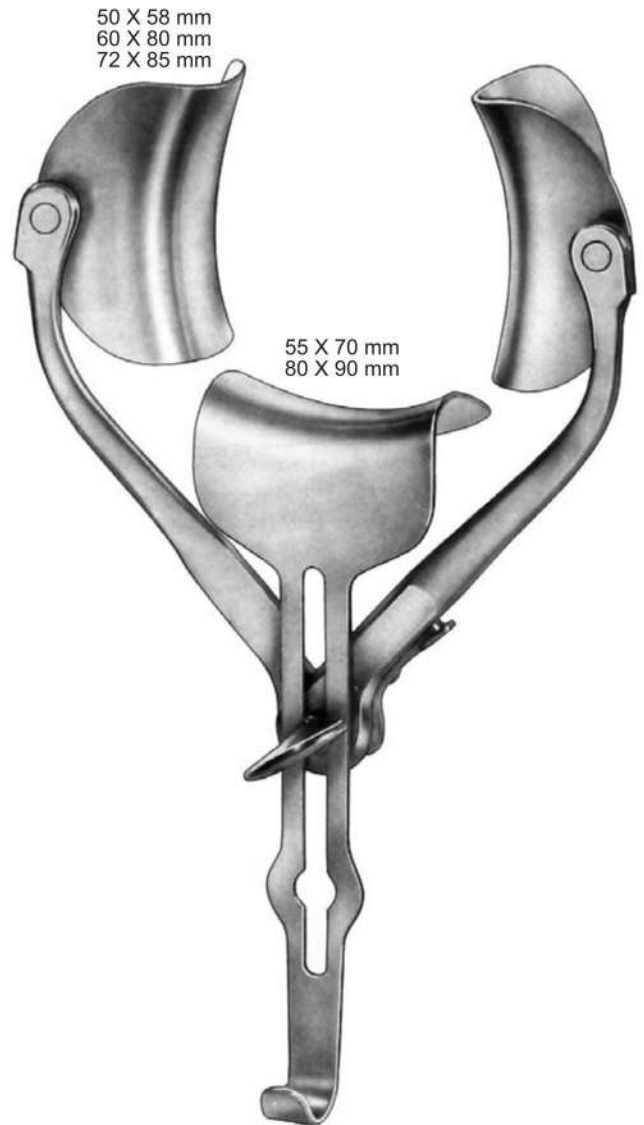

Ricard  
403-02-28 28 cm / 11"  
403-03-30 30 cm / 12"

**Wundhaken ; Separadores  
Retractors ; Divaricatori  
Ecarteurs ; Afastadores**



Oettingen  
404-01-16  
27 cm / 10½"  
Central blade 50 X 65 mm



Houzel  
404-02-16  
16 cm / 6¼"



Robin-Masse  
404-03-26

**Wundhaken ; Separadores  
Retractors ; Divaricatori  
Ecarteurs ; Afastadores**

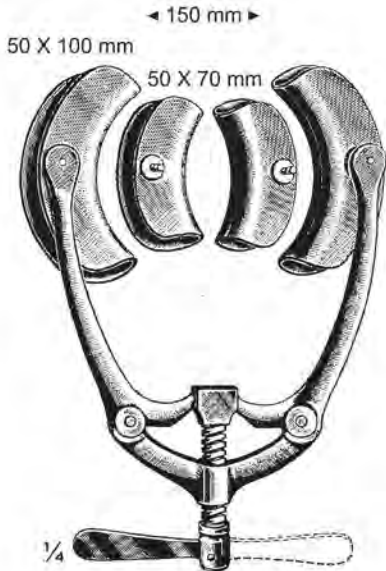

**Quervain**  
**405-01-15**  
24 cm / 9½"  
With 2 pairs of blades



<b>Perman</b>	Opening	Lateral Blades
<b>405-02-18</b>	18 cm / 7"	60 X 60 mm
<b>405-03-20</b>	20 cm / 8"	60 X 60 mm
<b>405-04-25</b>	25 cm / 10"	70 X 70 mm

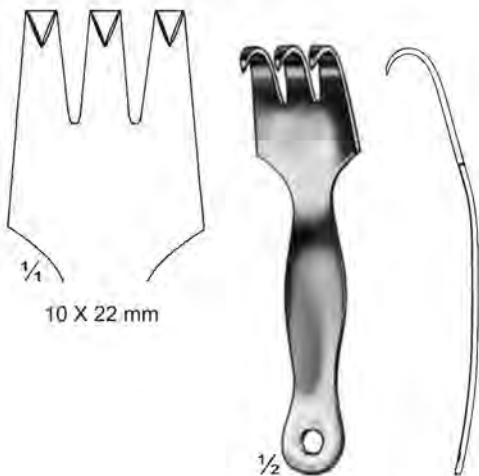

**405-05-10**  
10.5 cm / 4¼"

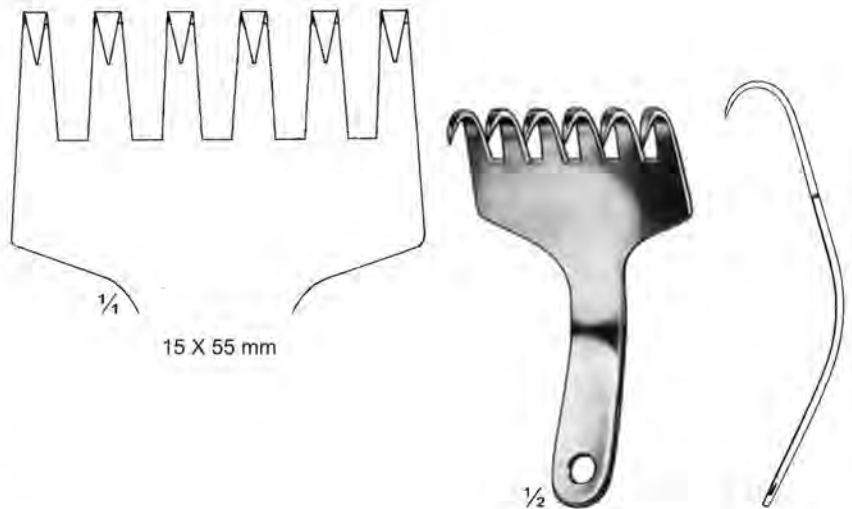

**405-06-10**  
10.5 cm / 4¼"

**Bauchdeckenhalter ; Separadores abdominales  
Abdominal Retractors ; Spatole addomiale  
E carteurs abdominaux ; Espátulas abdominais**

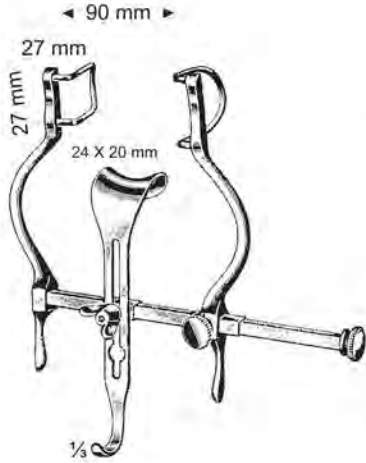

Balfour-Baby  
406-01-09



Hertzler  
406-02-10

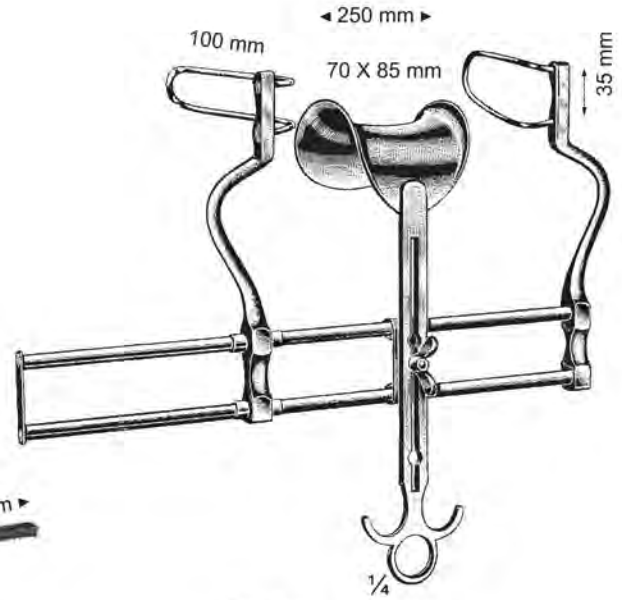

Balfour  
Opening Wire blades  
406-03-25 250 mm 35 X 100 mm  
406-04-28 280 mm 40 X 105 mm  
406-05-30 300 mm 40 X 110 mm

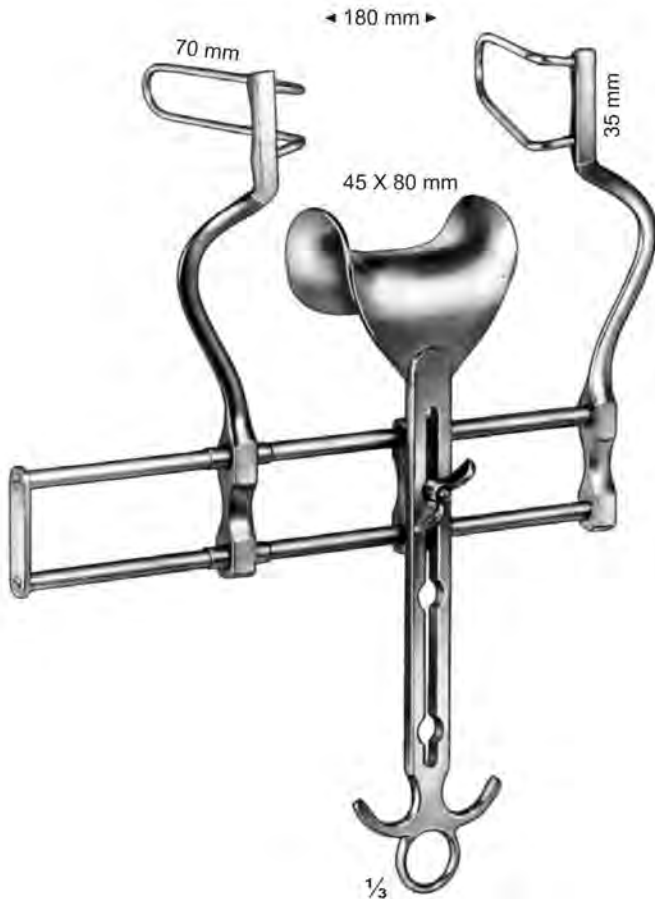

Balfour  
406-06-18 Opening 180 mm  
406-07-20 Opening 200 mm

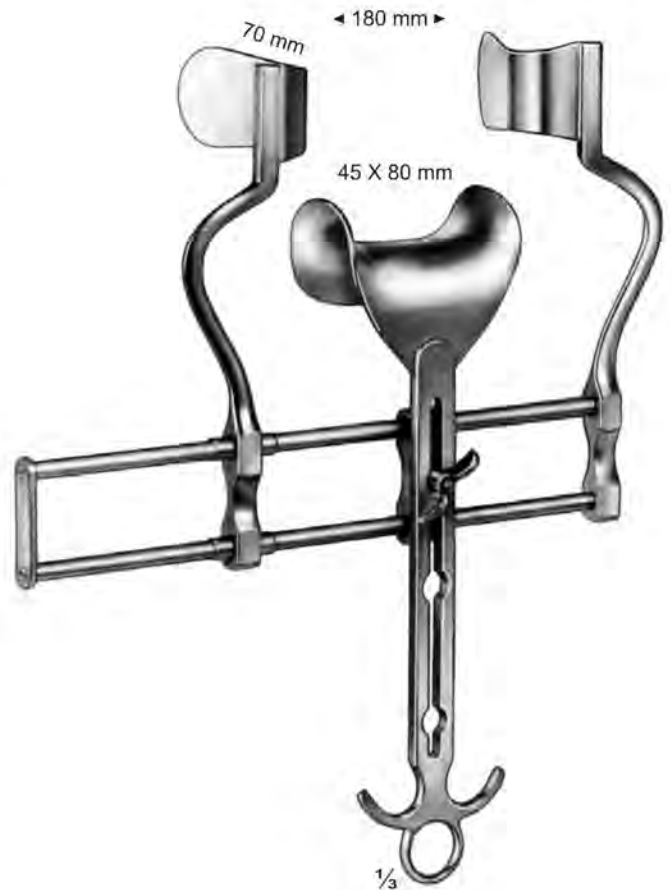

Balfour  
406-08-18 Opening 180 mm  
406-09-20 Opening 200 mm



**Bauchdeckenhalter ; Separadores abdominales  
Abdominal Retractors ; Spatole addominale  
E carteurs abdominaux ; Espátulas abdominais**

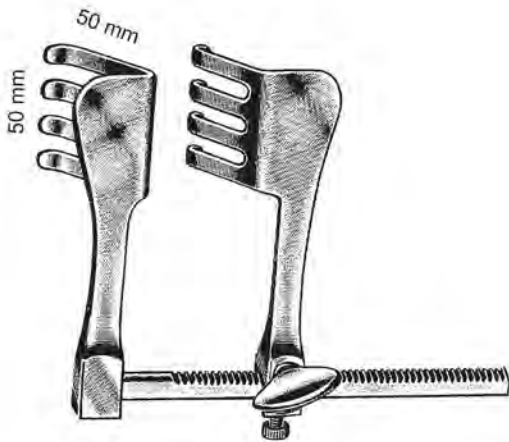

**Badgley**  
**407-01-15** Opening 15 cm / 6"  
**407-02-18** Opening 18 cm / 7"  
**407-03-20** Opening 20 cm / 8"

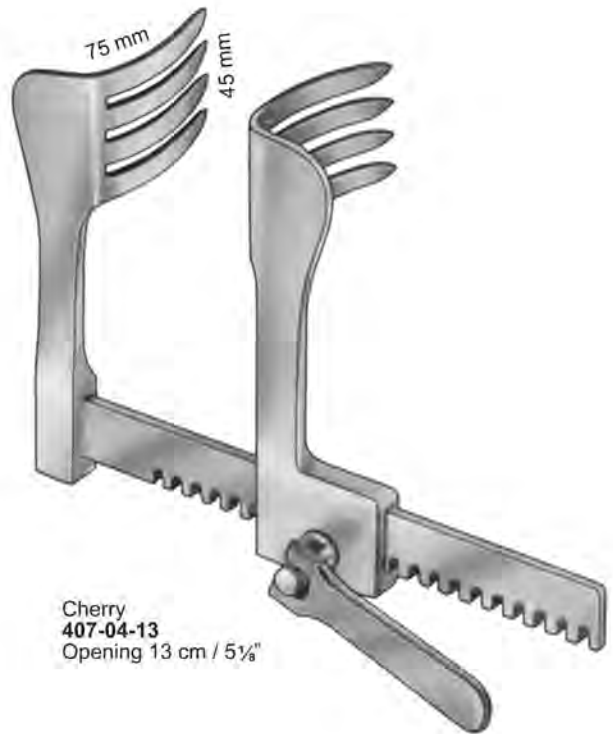

**Cherry**  
**407-04-13**  
 Opening 13 cm / 5 1/8"

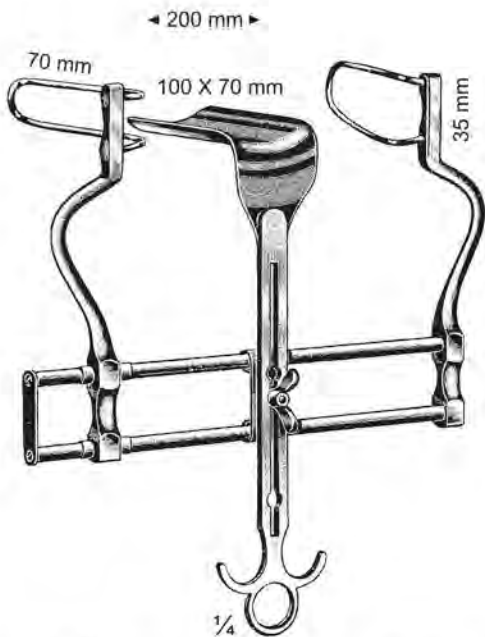

**Balfour**

	Opening	Lateral Blades	Central Blade
<b>407-05-18</b>	180 mm	70 X 35 mm	45 X 80 mm
<b>407-06-20</b>	200 mm	100 X 35 mm	100 X 70 mm
<b>407-07-25</b>	250 mm	100 X 35 mm	70 X 85 mm

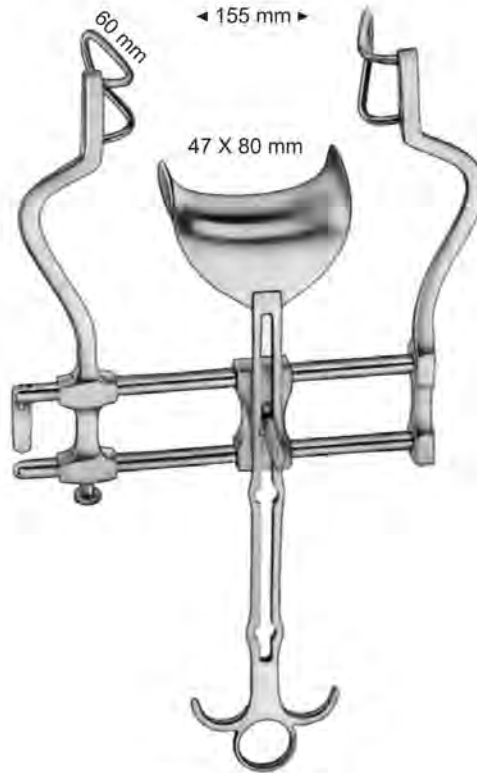

**Balfour**  
**407-08-12** Opening 125 mm  
**407-09-15** Opening 155 mm



**407-10-45** 45 X 80 mm  
**407-11-70** 70 X 85 mm  
**407-12-80** 80 X 90 mm  
 28 cm / 11"  
 Center blade



**Bauchdeckenhalter ; Separadores abdominales  
Abdominal Retractors ; Spatole addominale  
E carteurs abdominaux ; Espátulas abdominais**

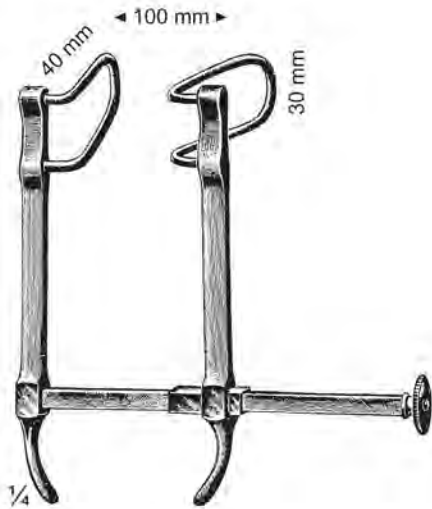

Gosset  
**408-01-10** Opening 10 cm / 4"  
**408-02-12** Opening 12 cm / 4¾"  
**408-03-13** Opening 13.5 cm / 5¼"

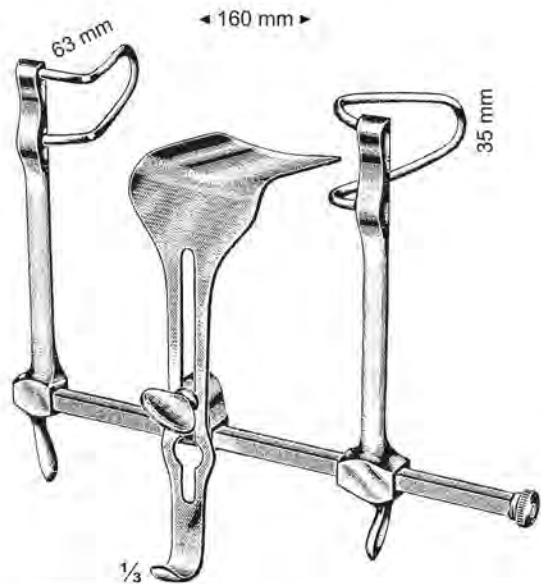

Gosset  
**408-04-16** Opening 16 cm / 6¼"  
**408-05-18** Opening 18.5 cm / 7¼"  
**408-06-22** Opening 22 cm / 8¾"

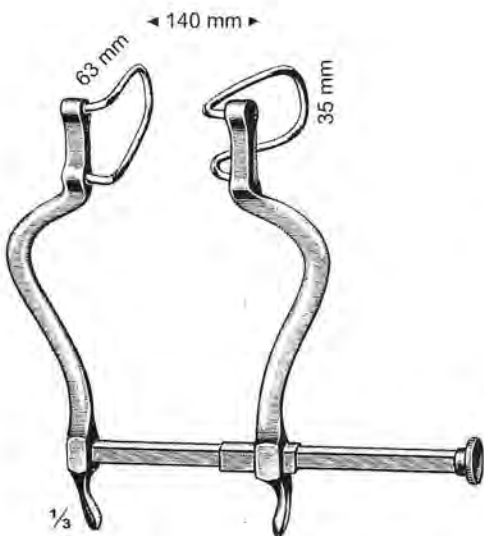

Gosset  
**408-07-14** Opening 14 cm / 5½"  
**408-08-15** Opening 15 cm / 6"  
**408-09-18** Opening 18 cm / 7"

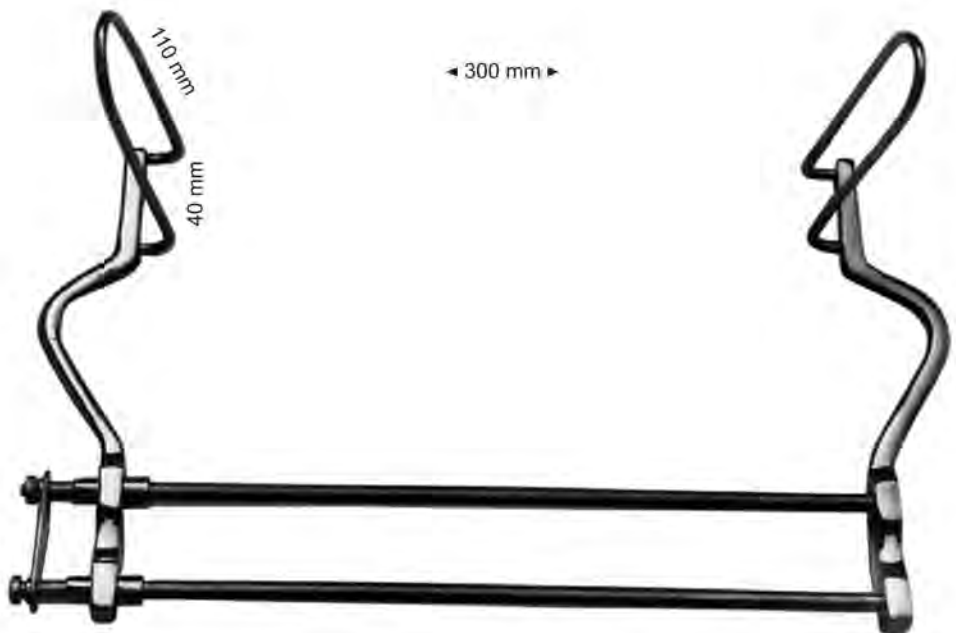

Gosset

	Opening	Lateral Blades
<b>408-10-12</b>	12 cm / 4¾"	55 X 30 mmm
<b>408-11-16</b>	16 cm / 6¼"	60 X 30 mmm
<b>408-12-18</b>	18 cm / 7"	100 X 35 mmm
<b>408-13-20</b>	20 cm / 8"	100 X 35 mmm
<b>408-14-24</b>	24 cm / 9½"	105 X 40 mmm
<b>408-15-30</b>	30 cm / 12"	110 X 40 mmm

Double shaft

**Bauchdeckenhalter ; Separadores abdominales  
 Abdominal Retractors ; Spatole addominali  
 E carteurs abdominaux ; Espátulas abdominais**



Scoville-Richter  
 409-01-17 Opening 17 cm / 6¾"  
 409-02-21 Opening 21 cm / 8¼"  
 409-03-23 Opening 23 cm / 9"  
 409-04-26 Opening 26 cm / 10¼"  
 With lateral blades 409-05-35 to 409-09-62

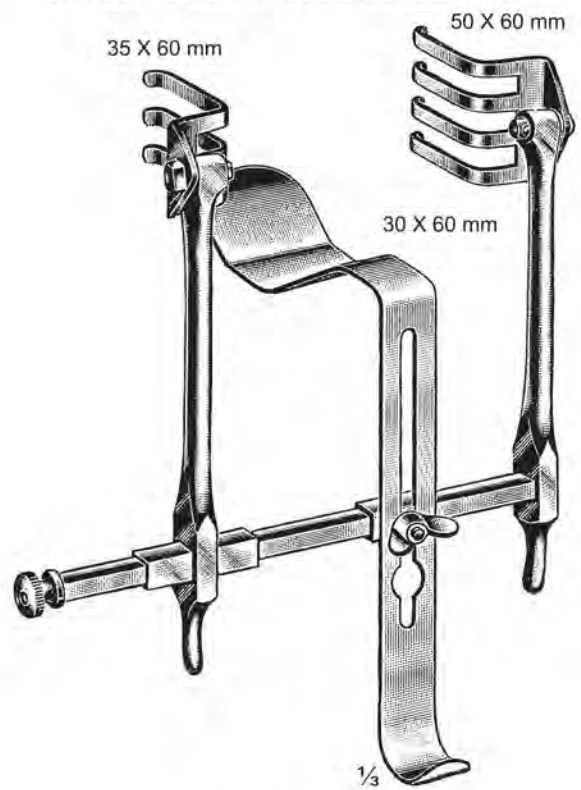

Ulrich-St. Gallen  
 409-10-16 Opening 16 cm / 6¼"  
 409-11-18 Opening 18 cm / 7"  
 409-12-21 Opening 21 cm / 8¼"



O'Sullivan-O'Conner  
 409-13-03  
 With three blades



**Bauchdeckenhalter ; Separadores abdominales  
Abdominal Retractors ; Spatole addominale  
E carteurs abdominaux ; Espátulas abdominais**

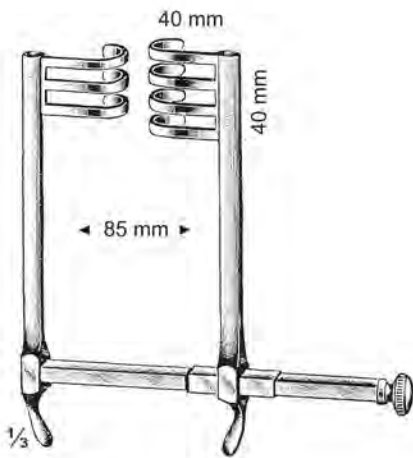

Frazier  
410-01-08  
Opening 8.5 cm / 3 1/4"

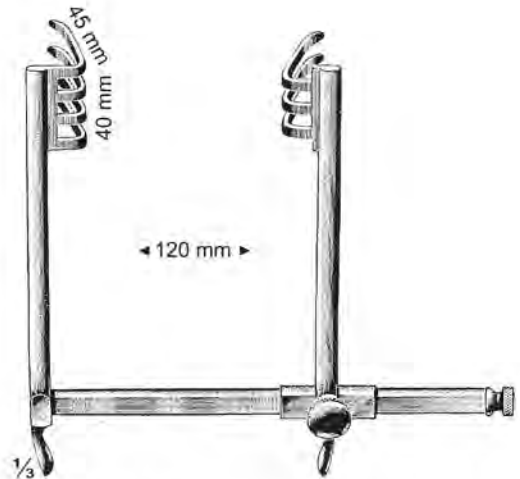

Temple Fay  
410-02-12  
Opening 12 cm / 4 3/4"

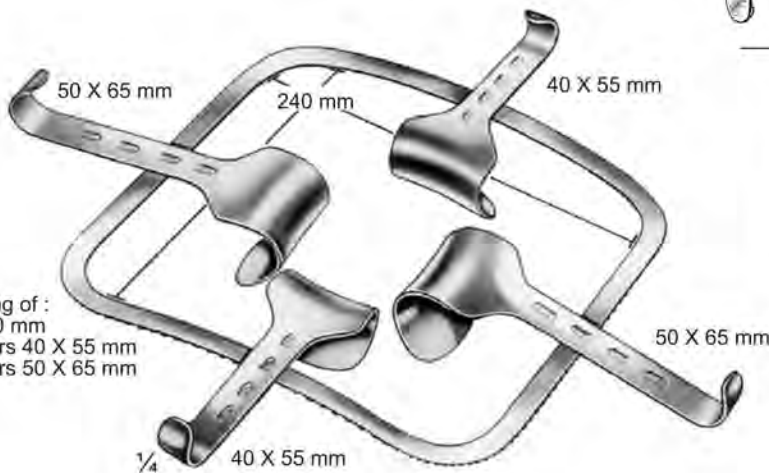

Kirschner  
410-03-05  
Complete consisting of :  
1 Frame 240 X 240 mm  
2 Hook-on retractors 40 X 55 mm  
2 Hook-on retractors 50 X 65 mm

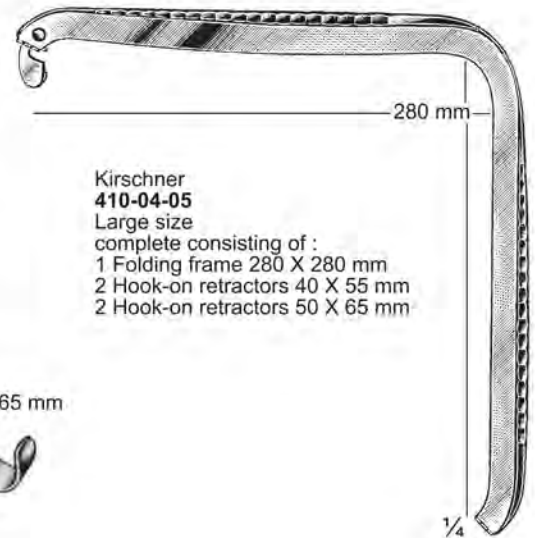

Kirschner  
410-04-05  
Large size  
complete consisting of :  
1 Folding frame 280 X 280 mm  
2 Hook-on retractors 40 X 55 mm  
2 Hook-on retractors 50 X 65 mm



410-05-40  
40 X 55 mm



410-06-50  
50 X 65 mm



410-07-60  
60 X 85 mm



410-08-78  
78 X 65 mm



410-09-80  
80 X 90 mm

**Bauchdeckenhalter ; Separadores abdominales  
Abdominal Retractors ; Spatole addominale  
E carteurs abdominaux ; Espátulas abdominais**

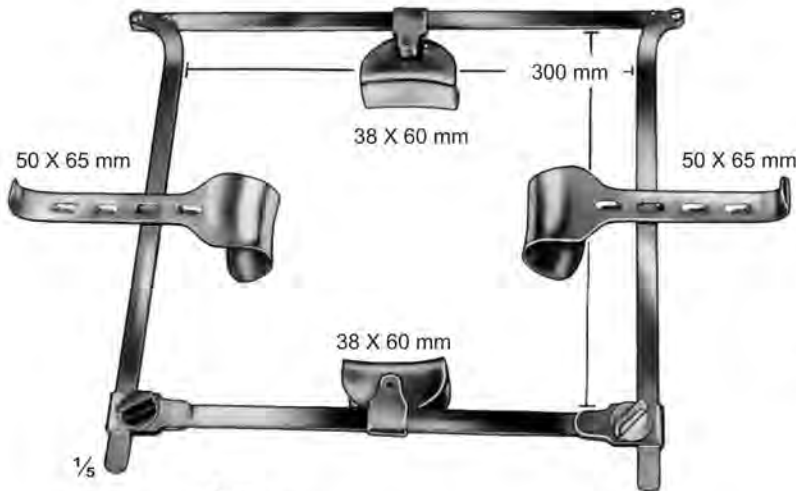

- Franz**  
**411-01-05**  
Complete consisting of :  
1 Folding frame 300 X 300 mm  
2 Hook-on retractors 50 X 65 mm  
2 Exchangeable blades 38 X 60 mm  
**411-02-09**  
Complete consisting of :  
1 Folding frame 300 X 300 mm  
2 Hook-on retractors 50 X 65 mm  
2 Hook-on retractors 60 X 85 mm  
2 Exchangeable blades 38 X 60 mm  
2 Exchangeable blades 45 X 80 mm



**411-03-30**  
Folding frame 300 X 300 mm

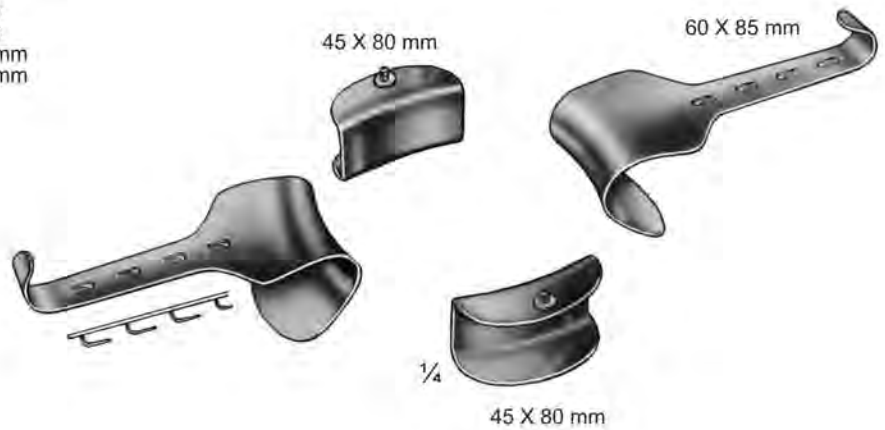

Hook-on retractors for 411-01-05 & 411-02-09



**411-05-98**  
98 X 35 mm

**411-06-105**  
105 X 35 mm

Exchangeable blades for 411-01-05 & 411-02-09



**411-07-38**  
38 X 60 mm

**411-08-45**  
45 X 80 mm

**Bauchdeckenhalter ; Separadores abdominales**  
**Abdominal Retractors ; Spatole addominale**  
**E carteurs abdominaux ; Espátulas abdominais**

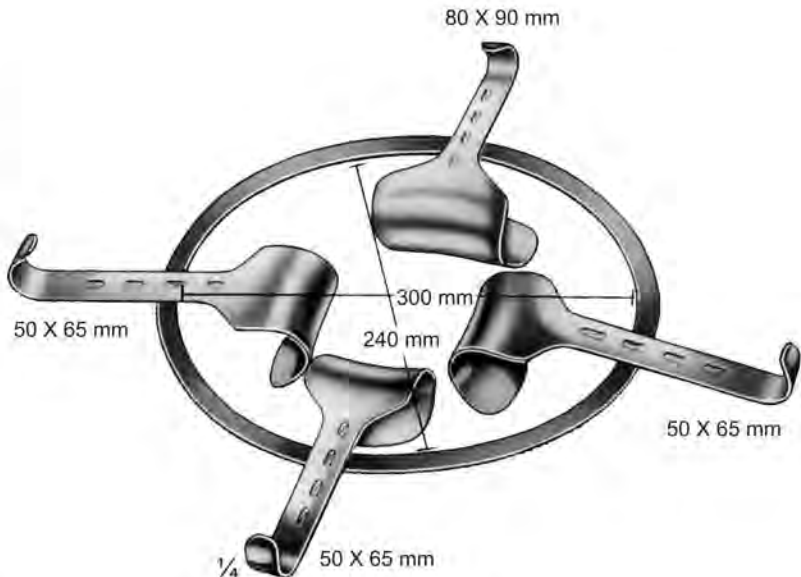

Kirschner (Semm), oval  
**412-01-07**  
 Complete consisting of :  
 1 Frame 300 X 240 mm  
 3 Hook-on retractors 50 X 65 mm  
 1 Hook-on retractor 80 X 90 mm  
 1 Hook-on retractor 98 X 50 mm  
 1 Hook-on retractor 105 X 35 mm

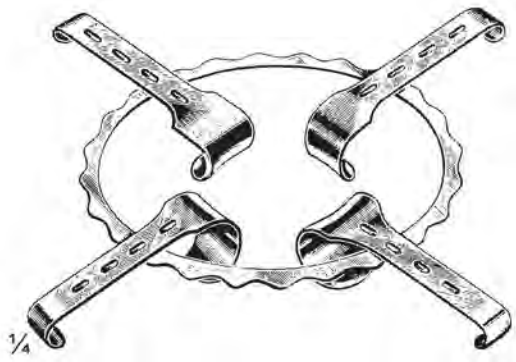

Denis-Browne  
**412-02-05**  
 Complete consisting of :  
 1 Frame 175 X 150 mm  
 2 Hook-on retractors 40 X 30 mm  
 2 Hook-on retractor 40 X 40 mm

Hook-on retractors for 412-01-07

Hook-on retractors for 412-01-07,  
 Intestinal and bladder





**Bauchdeckenhalter ; Separadores abdominales  
Abdominal Retractors ; Spatole addominale  
E carteurs abdominaux ; Espátulas abdominais**



1/2

**413-01-85**  
85 cm / 34"  
Chain only  
**413-02-250** 250 grs Weight only  
**413-03-400** 400 grs Weight only

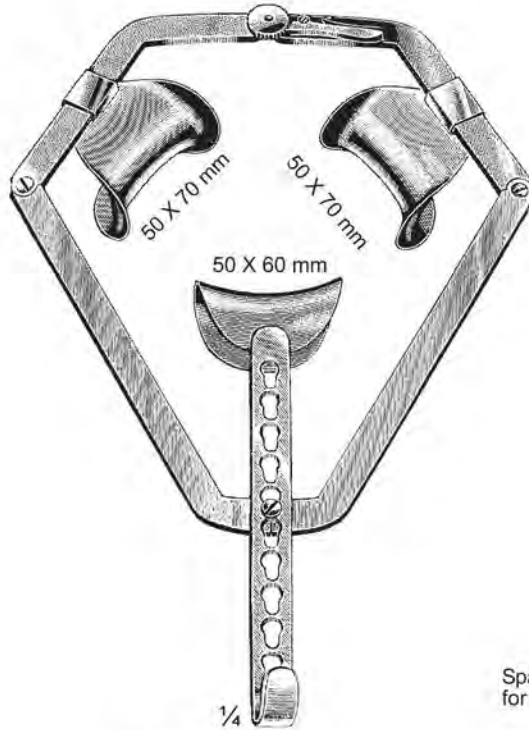

1/4

**413-04-04**  
Complete consisting of :  
1 Frame 240 X 240 mm  
1 Hook-on retractor 50 X 60 mm  
2 Blades 50 X 70 mm



1/4

**413-08-00**  
Spare button  
for 413-05-17

Spare blades  
for 413-05-17



1/2

**413-07-75**  
75 X 65 mm



255 mm

**413-05-17**  
Complete consisting of :  
1 Frame 255 X 255 mm  
4 Blades 50 X 65 mm  
12 Buttons



1/2

**413-06-50**  
50 X 65 mm

Bauchdeckenhalter ; Separadores abdominales  
 Abdominal Retractors ; Spatole addominale  
 E carteurs abdominaux ; Espátulas abdominais

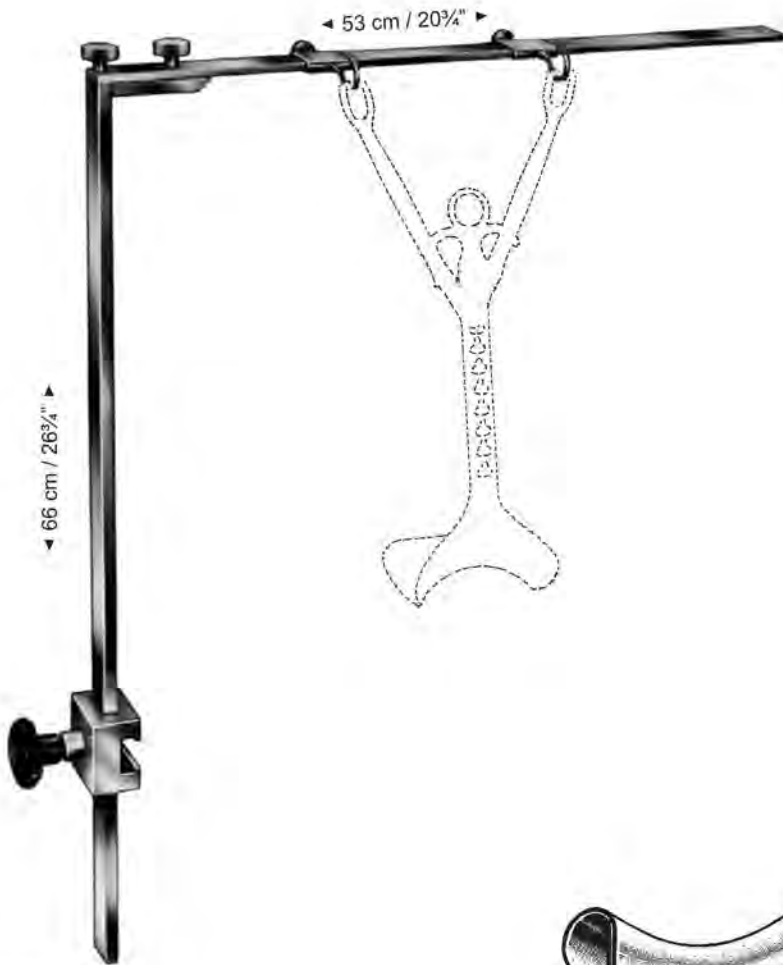

**414-01-66**  
 Mounting frame for fastening of 414-02-19 & 414-03-95 to the lateral bars of the operating tables, can be dismantled for sterilization.

- 414-03-95 95 mm
- 414-04-105 105 mm
- 414-05-120 120 mm
- 414-06-135 135 mm
- 414-07-155 155 mm

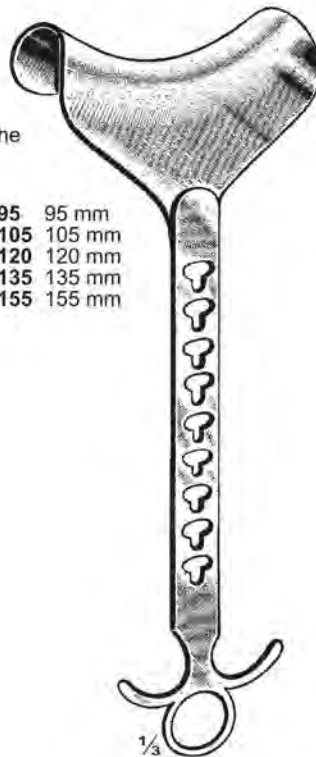

Rochard  
**414-03-95 To 414-07-155**  
 27 cm / 10 1/2"



Rochard  
**414-02-19**  
 Fixation device for  
 414-03 to 414-07

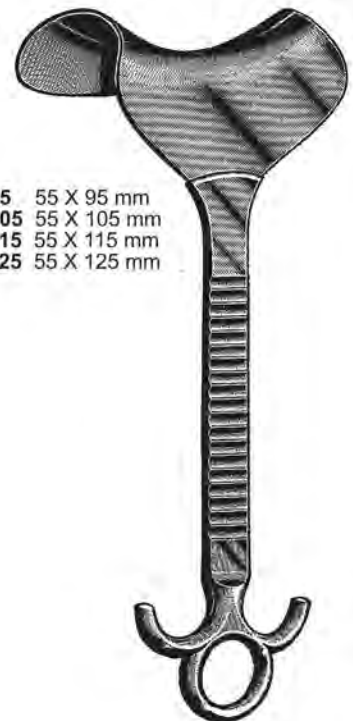

Doyen  
**414-08-95 To 414-11-125**  
 28 cm / 11"

Laminectomy-Wundspreizer ; Separadores para laminectomía  
Laminectomy Spreaders ; Divaricatori per laminectomia  
Ecarteurs pour laminectomie ; Separadores laminectomia

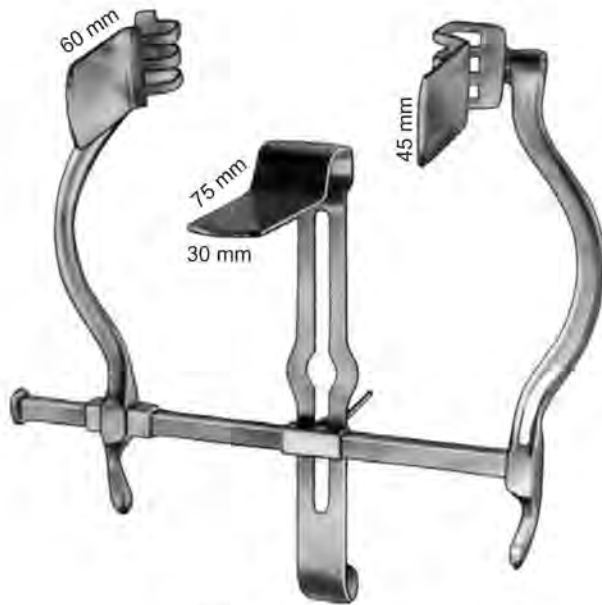

Judd-Masson  
415-01-11 Opening 11 cm / 4 1/4"  
415-02-16 Opening 16.5 cm / 6 1/2"  
415-03-18 Opening 18 cm / 7"  
415-04-21 Opening 21 cm / 8 1/4"

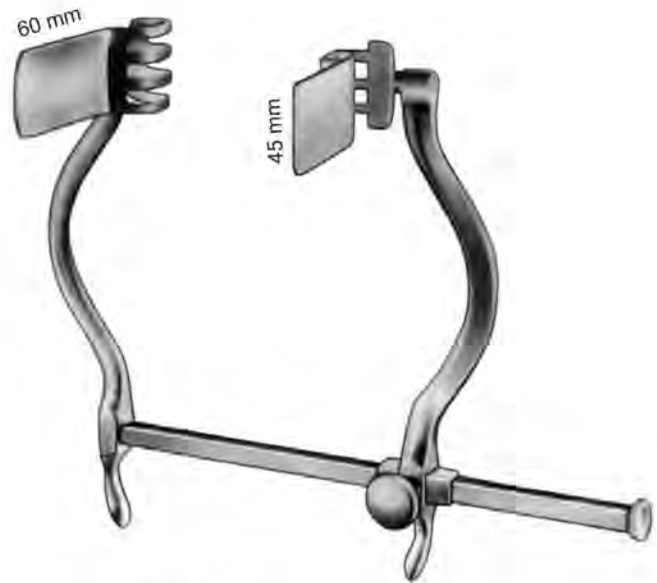

Judd-Masson  
415-05-11 Opening 11 cm / 4 1/4"  
415-06-16 Opening 16.5 cm / 6 1/2"  
415-07-18 Opening 18 cm / 7"  
415-08-21 Opening 21 cm / 8 1/4"

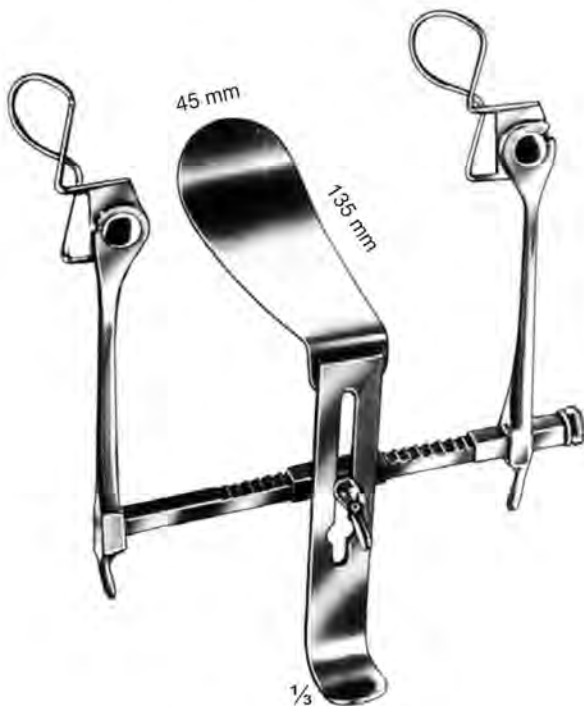

Jacobson  
415-09-03  
2 Lateral blades 30 X 75 mm  
1 Central blade 45 X 90 mm  
415-10-03  
2 Lateral blades 45 X 130 mm  
1 Central blade 45 X 135 mm

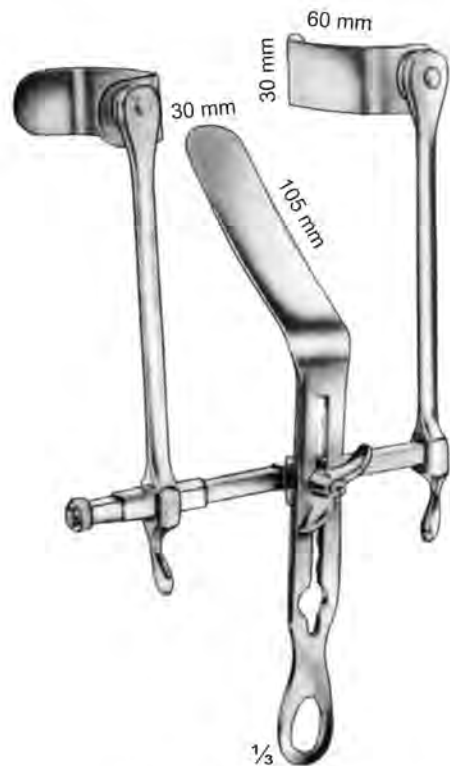

Thomsan-Walker  
415-11-12 Opening 12 cm / 4 3/4"  
415-12-14 Opening 14.5 cm / 5 3/4"



**Laminectomy-Wundspreizer ; Separadores para laminectomía  
Laminectomy Spreaders ; Divaricatori per laminectomia  
Ecarteurs pour laminectomie ; Separadores laminectomia**

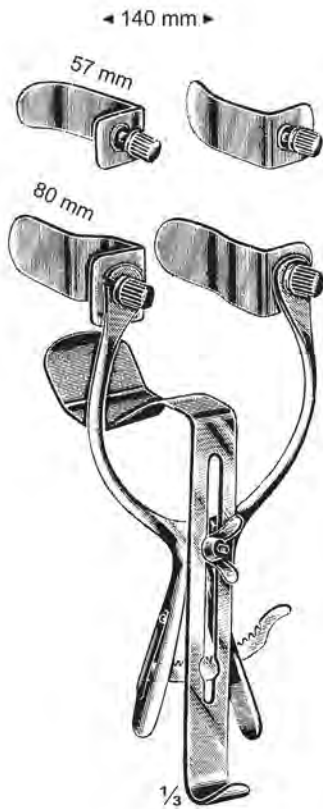

Millin  
**416-01-14**  
19.5 cm / 7<sup>3</sup>/<sub>4</sub>"  
2 pairs of lateral blades  
and 1 central blade



Millin  
**416-02-18**  
18 cm / 7"  
2 Lateral blades 57 X 25 mm  
2 Lateral blades 80 X 25 mm  
1 Central blade 110 X 45 mm

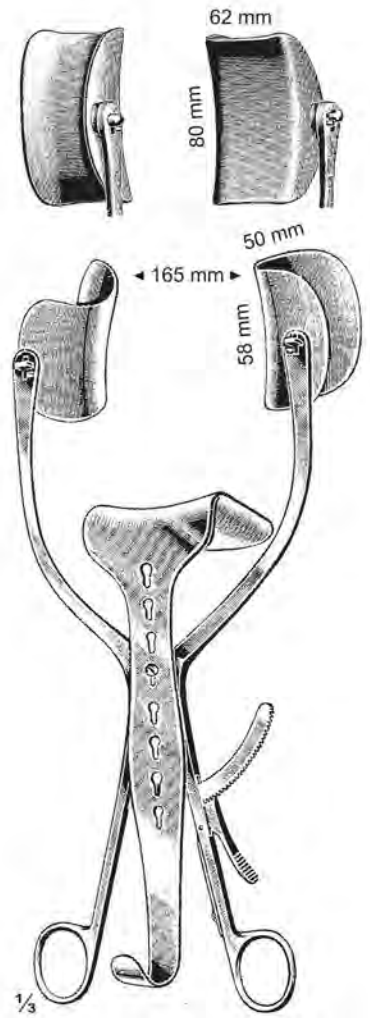

Collin  
**416-03-16** Lateral blades 50 X 58 mm Central blade 62 X 67 mm  
**416-04-16** Lateral blades 62 X 80 mm Central blade 62 X 80 mm  
30 cm / 12"

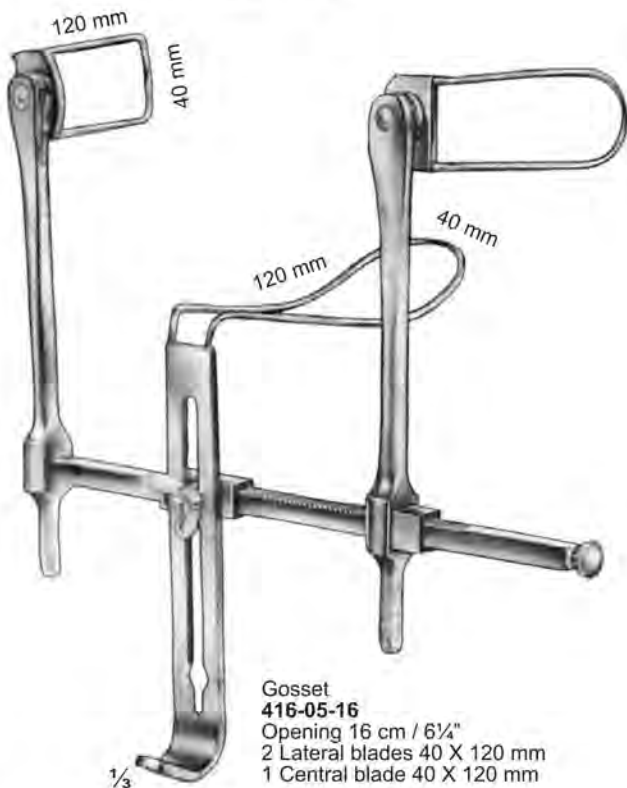

Gosset  
**416-05-16**  
Opening 16 cm / 6<sup>1</sup>/<sub>4</sub>"  
2 Lateral blades 40 X 120 mm  
1 Central blade 40 X 120 mm

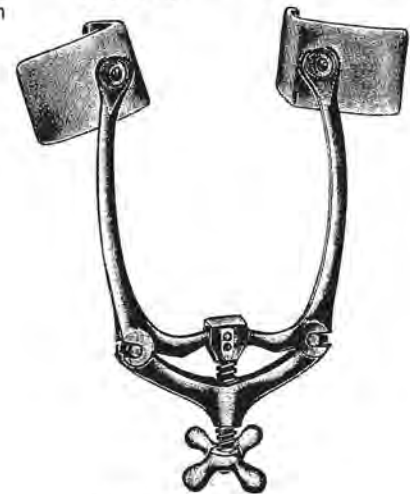

Quervain  
**416-06-24**  
24 cm / 9<sup>1</sup>/<sub>2</sub>"  
Lateral blades 50 X 50 mm

Laminectomy-Wundspreizer ; Separadores para laminectomía  
 Laminectomy Spreaders ; Divaricatori per laminectomia  
 Ecarteurs pour laminectomie ; Separadores laminectomia



Legueu  
 417-01-18  
 18 cm / 7"



Millan  
 417-03-26  
 26 cm / 10 1/4"  
 Meatus clamp  
 (Bladder neck spreader)



Millan-Bacon  
 417-02-15  
 Opening 15 cm / 6"  
 2 Lateral blades 45 X 25 mm  
 2 Lateral blades 60 X 30 mm  
 1 Central blade 135 X 45 mm



Laminectomy-Wundspreizer ; Separadores para laminectomía  
Laminectomy Spreaders ; Divaricatori per laminectomia  
Ecarteurs pour laminectomie ; Separadores laminectomia



**Laminectomy-Wundspreizer ; Separadores para laminectomía  
Laminectomy Spreaders ; Divaricatori per laminectomia  
Ecarteurs pour laminectomie ; Separadores laminectomia**



Scoville-Haverfield  
**419-01-15**  
Opening 15 cm / 6"



Scoville  
**419-02-15**  
Opening 15 cm / 6"



Scoville  
**419-03-50** 50 mm  
**419-04-75** 75 mm



419-05-38 To 419-35-100 accessories  
for 419-01-15 & 419-02-15

Scoville  
**419-05-38** 38 mm  
**419-06-50** 50 mm  
**419-07-70** 70 mm



Scoville  
**419-08-40** 40 X 38 mm  
**419-09-67** 67 X 44 mm



Taylor  
**419-10-44** 44 X 38 mm



Taylor  
**419-11-48** 48 X 50 mm  
**419-12-64** 64 X 64 mm  
**419-13-80** 80 X 57 mm



Scoville  
**419-14-64** 64 X 25 mm  
**419-15-64** 64 X 50 mm  
**419-16-67** 67 X 28 mm  
**419-17-88** 88 X 25 mm



Hibbs  
**419-18-50** 50 X 19 mm  
**419-19-50** 50 X 25 mm  
**419-20-50** 50 X 50 mm  
**419-21-64** 64 X 25 mm  
**419-22-64** 64 X 38 mm  
**419-23-75** 75 X 25 mm  
**419-24-75** 75 X 38 mm  
**419-25-75** 75 X 50 mm  
**419-26-100** 100 X 25 mm  
**419-27-100** 100 X 50 mm



Meyerding  
**419-28-50** 50 X 25 mm  
**419-29-57** 57 X 25 mm  
**419-30-70** 70 X 25 mm  
**419-31-75** 75 X 25 mm  
**419-32-83** 83 X 25 mm  
**419-33-88** 88 X 50 mm



Taylor  
**419-34-75** 75 X 32 mm  
**419-35-100** 100 X 42 mm

**Hämmer ; Martillos y massos  
Mallets ; Martelli  
Maillets et masses ; Martelos**



**420-01-140**  
16.5 cm / 6 1/2"



Mead  
**420-02-320**  
17 cm / 6 3/4"



Lucae  
**420-03-230 & 420-04-260**  
19 cm / 7 1/2"

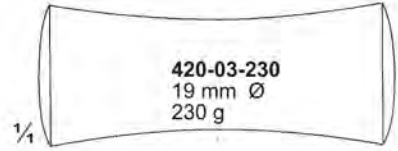

Doyen  
**420-05-120 To 420-07-260**  
21 cm / 8 1/4"

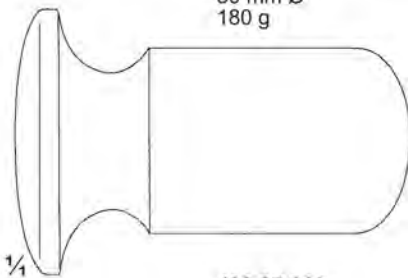
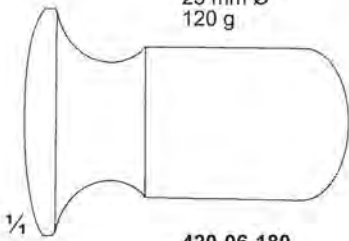
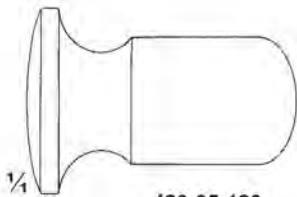

**420-07-260**  
35 mm Ø  
260 g



Hajek  
**420-08-140**  
21.5 cm / 8 1/2"



**420-11-400**  
30 mm Ø  
400 g



Williger  
**420-09-300 To 420-11-400**  
24 cm / 9 1/2"

Hämmer ; Martillos y massos  
Mallets ; Martelli  
Maillets et masses ; Martelos

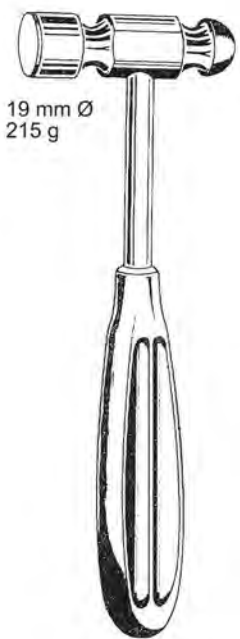

19 mm Ø  
215 g

421-01-215  
19 cm / 7½"



30 mm Ø  
400 g

Gerzog  
421-02-400  
18 cm / 7"



40 mm Ø  
690 g

Kirk  
421-03-690  
19.5 cm / 7¾"



40 mm Ø  
780 g

Ombredanne  
421-04-780  
23 cm / 9"



40 mm Ø  
510 g

Bergmann (Hibbs)  
421-05-510  
23 cm / 9"

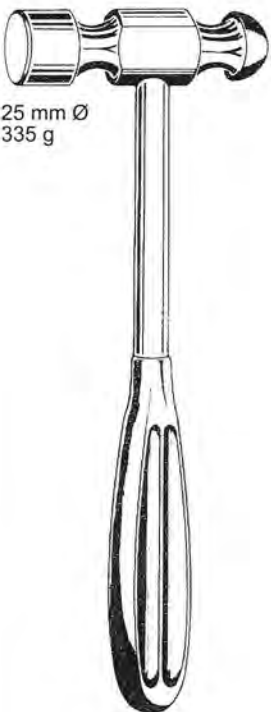

25 mm Ø  
335 g

421-06-335  
23 cm / 9"



30 mm Ø  
240 g  
1 Side flat  
1 Side convex

½  
Cottle  
421-07-240  
18.5 cm / 7¼"



300 g

½  
Bergmann  
421-08-300  
24 cm / 9½"



300 g

½  
Bergmann  
421-09-300  
24 cm / 9½"

Hämmer ; Martillos y massos  
Mallets ; Martelli  
Maillets et masses ; Martelos



25 mm Ø  
200 g

422-01-200  
18.5 cm / 7¼"



42 mm Ø  
530 g

422-02-530  
24 cm / 9½"

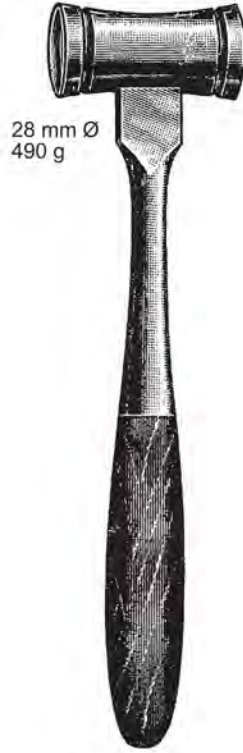

28 mm Ø  
490 g

422-03-490  
23 cm / 9"



490 g

422-04-490  
24 cm / 9½"



165 g

½

422-05-165  
19 cm / 7½"



50 mm Ø  
400 g

422-06-400  
26 cm / 10¼"



30 mm Ø  
215 g

422-07-215  
24 cm / 9½"



30 mm Ø  
220 g

½

Collin  
422-08-220  
20 cm / 8"



Hämmer ; Martillos y massos  
Mallets ; Martelli  
Maillets et masses ; Martelos

80 X 60 mm Ø



400 g

1/2

Steinbach  
423-01-400  
24 cm / 9 1/2"



423-02-350 350 g  
423-03-500 500 g

423-02-350 & 423-03-500  
23 cm / 9"



30 mm Ø  
510 g

423-04-510  
26.5 cm / 10 1/2"



423-05-26  
26.5 cm / 10 1/2"  
Repercussion free



800 g

1/2

Heath  
423-06-800  
18 cm / 7"



22 mm Ø  
200 g

1/2

Partsch  
423-07-200  
18 cm / 7"



423-08-150  
35 mm Ø, 150 g  
423-09-240  
45 mm Ø, 240 g  
423-10-330  
50 mm Ø, 330 g

423-08-150 To 423-10-330  
26 cm / 10 1/4"

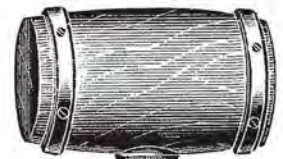

45 mm Ø  
250 g

423-11-250  
23 cm / 9"





Hämmer ; Martillos y massos  
Mallets ; Martelli  
Maillets et masses ; MartelosMaillets



42 mm Ø  
400 g

1/2

424-01-400  
26 cm / 10 1/4"



42 mm Ø  
250 g  
400 g

1/2

424-02-26  
26 cm / 10 1/4"



35 mm Ø  
Without disks  
130 g



424-05-230 230 g  
Spare metal disks  
for 424-03-360 & 424-04-360  
1 metal disk flat  
1 metal disk convex



424-06-00  
Wrench



30 mm Ø  
125 g

424-07-125  
18 cm / 7"



30 mm Ø  
215 g

424-08-215  
24.5 cm / 9 3/4"

1/2

Wagner  
424-03-360  
Complete with  
1 pair of metal disks  
424-04-360  
Complete with  
1 pair of metal disks  
1 wrench  
23.5 cm / 9 1/4"



42 mm Ø  
530 g

30 mm Ø

424-09-530  
26.5 cm / 10 1/2"





**Meniskotome, Meniskusmesser ; Meniscótomos  
Meniscectomy Knives ; Meniscotomi  
Méniscotomes ; Méniscotomes**

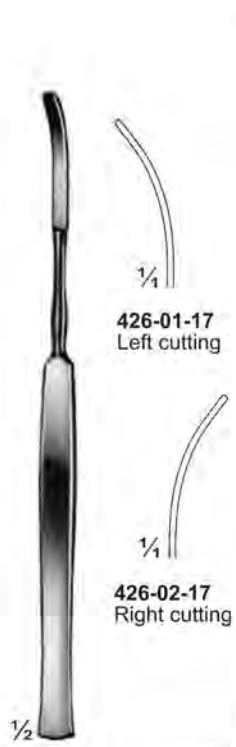

Swiss Model  
426-01-17 & 426-02-17  
17 cm / 6 3/4"



Bircher  
426-03-19 & 426-04-19  
19 cm / 7 1/2"



Bircher  
426-05-19  
19 cm / 7 1/2"



Bircher  
426-06-19  
19 cm / 7 1/2"

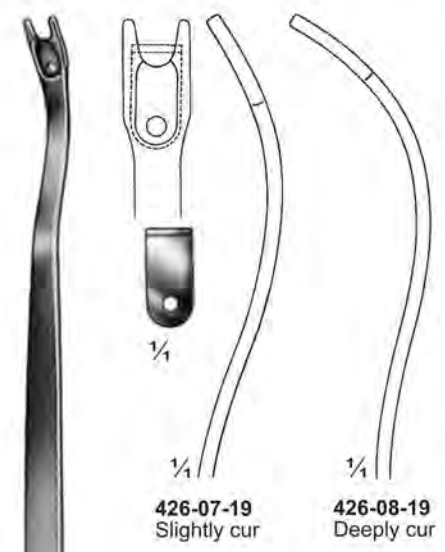

Stryker-Scholl  
426-07-19 & 426-08-19  
19 cm / 7 1/2"

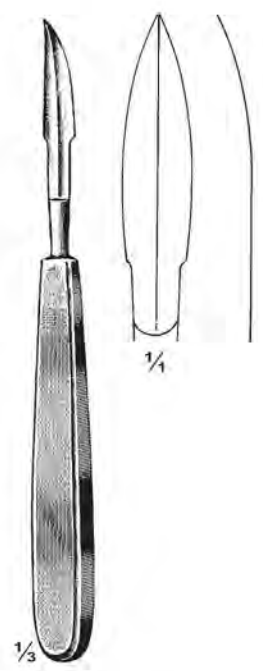

426-09-25  
25 cm / 10"

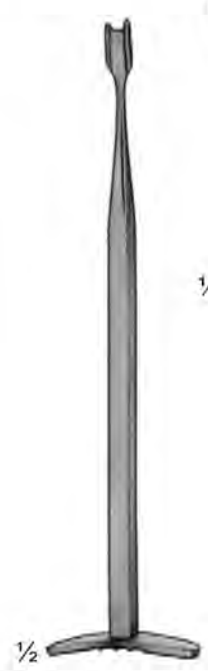

Smillie  
426-10-17 To 426-12-17  
17 cm / 6 3/4"



426-10-17



426-11-17

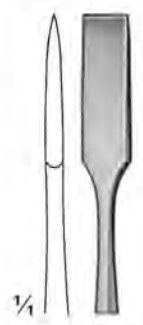

426-12-17



Canad. Model  
426-13-20 & 426-14-20  
20 cm / 8"



426-13-20



426-14-20

**Meniskotome, Meniskusmesser ; Meniscótomos  
Meniscectomy Knives ; Meniscotomi  
Méniscotomes ; Méniscotomes**



1/4

427-01-21



1/4

427-02-21



1/2

Salenius  
427-03-22 & 427-04-22  
22 cm / 8 3/4"



1/4

427-03-22

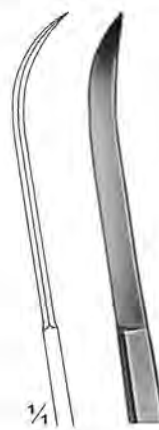

1/4

427-04-22



1/2

Wagner  
427-05-21  
21.5 cm / 8 1/2"



1/4

Neff  
427-01-21 & 427-02-21  
21.5 cm / 8 1/2"

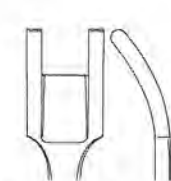

Lowe-Breck  
427-06-25



1/2

427-06-25 & 427-07-25  
25 cm / 10"

1/4

Downing  
427-07-25

1/4



1/2

427-08-25 & 427-09-25  
25 cm / 10"

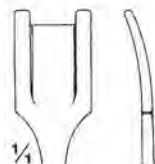

1/4

Lowe-Breck  
427-08-25

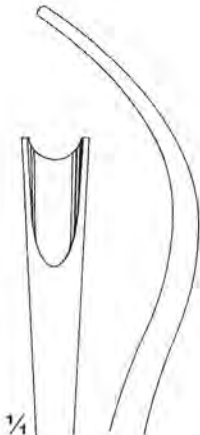

1/4

Downing  
427-09-25

**Knorpelfasszangen ; Pinzas para cartilagos  
Cartilage Grasping Forceps ; Pinze per cartilagini  
Daviers à cartilage ; Pinças cartilagem**

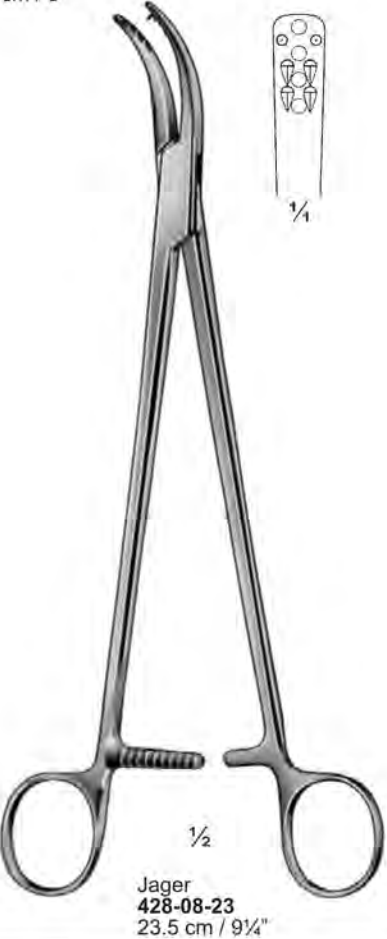
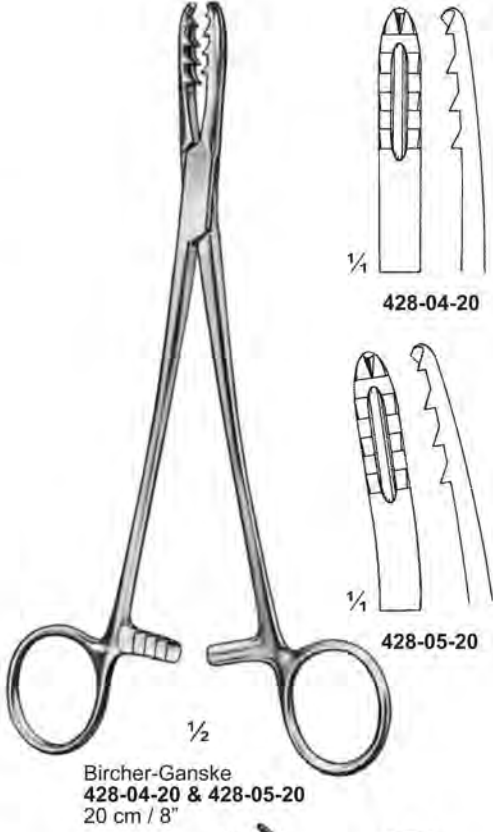
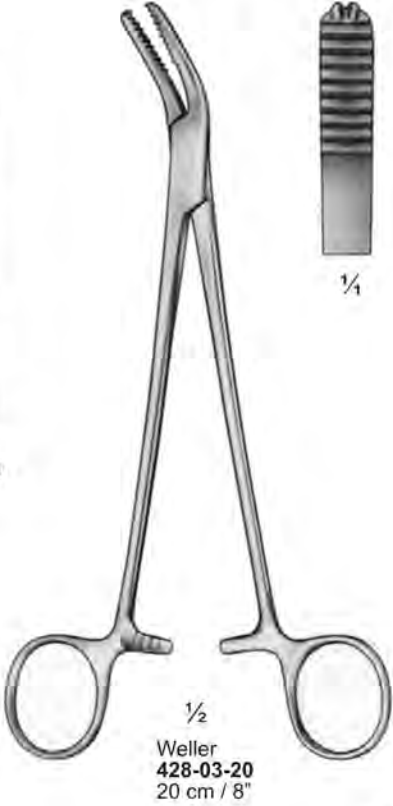
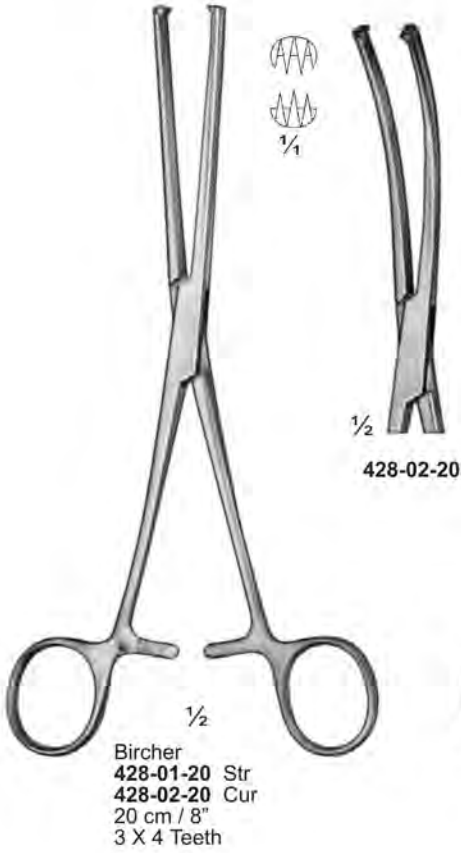

**Sehnenfasszangen ; Pinzas para agarrar tendones  
Tendon Seizing Instruments ; Pinze afferatendini  
Pinces pour saisir les tendons ; Pinças para tendão**

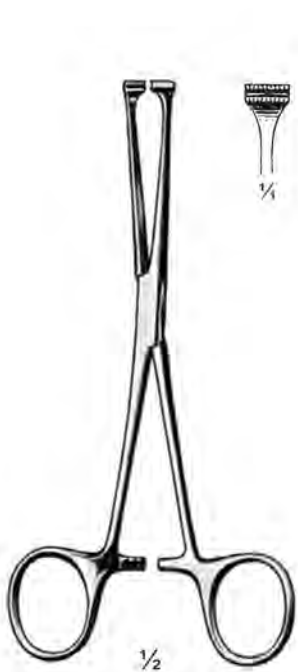

Steinmann  
429-01-16  
16 cm / 6 1/4"

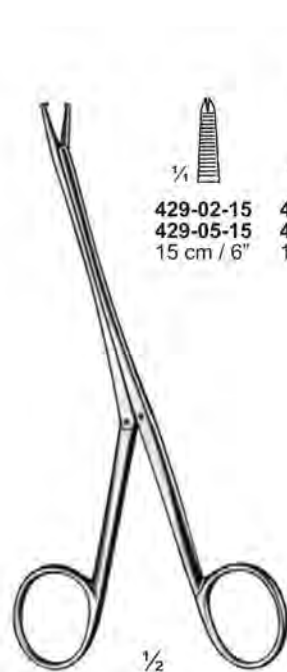

Brand  
429-02-15 To 429-04-25  
1 X 2 Teeth

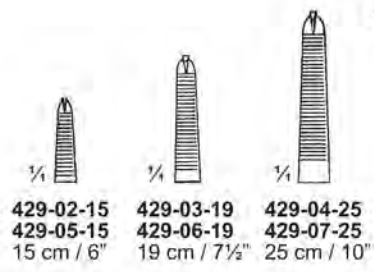

Brand  
429-05-15 To 429-07-25  
1 X 2 Teeth

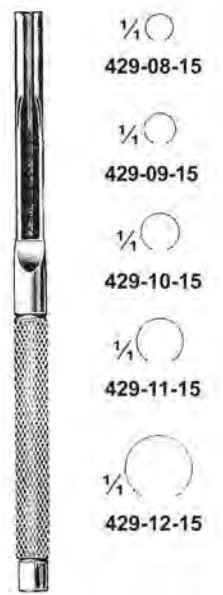

Bunnell  
429-08-15 To 429-12-15  
15 cm / 6"



429-13-20 & 429-14-20  
20 cm / 8"  
1 X 2 Teeth

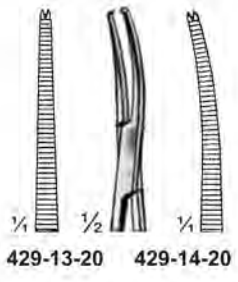

429-15-01 To 429-18-05  
10 cm / 4"

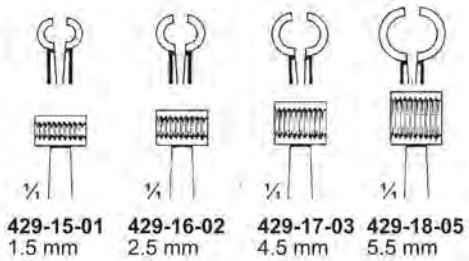

429-19-04 To 429-21-05  
23 cm / 9"



429-22-04 To 429-24-05  
23 cm / 9"

Sehnenfazzangen ; Pinzas para agarrar tendones  
 Tendon Seizing Instruments ; Pinze afferatendini  
 Pinces pour saisir les tendons ; Pinças para tendão



Fischer  
 430-01-31  
 31 cm / 12¼"



Fischer  
 430-06-31  
 31 cm / 12¼"



Brand  
 430-02-30 & 430-03-50



¼  
 430-02-30  
 30 cm / 12"  
 Ø 3 mm



¼  
 430-03-50  
 50 cm / 20"  
 Ø 6 mm



¼  
 430-07-28  
 28.5 cm / 11¼"



Brand  
 430-04-50  
 50 cm / 20"



¼



¼  
 Bunnell  
 430-08-33  
 33.5 cm / 13¼"



430-05-34  
 34 cm / 13½"



¼  
 Ø 7 mm

**Sehnenfazzangen ; Pinzas para agarrar tendones  
Tendon Seizing Instruments ; Pinze afferatendini  
Pinces pour saisir les tendons ; Pinças para tendão**

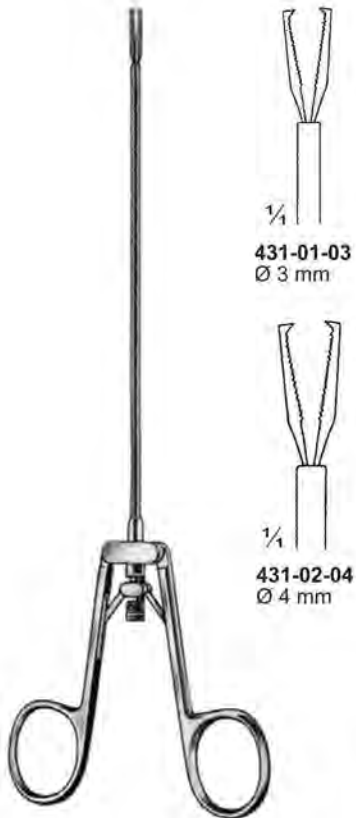

**Kleinert-Kutz**  
**431-01-03 & 431-02-04**  
20 cm / 8"  
Shaft length 13 cm / 5 1/8"  
1 X 2 Teeth



**Kleinert-Kutz**  
**431-03-20**  
20 cm / 8"  
1 X 2 Teeth



**Herz**  
**431-04-15 & 431-05-15**  
15 cm / 6"



**Jager**  
**431-06-27**  
Flexible shaft 27.5 cm / 10 3/4"



**Sehnenfasszangen ; Pinzas para agarrar tendones  
Tendon Seizing Forceps ; Pinze afferatendini  
Pincès à saisir les tendons ; Pinças para tendão**



Caroll  
432-01-11  
11 cm / 4 1/4"

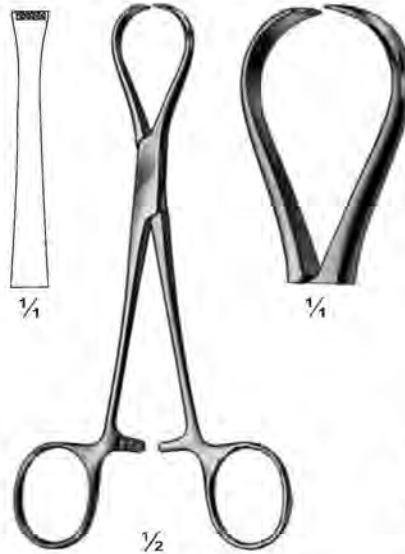

Jackson  
432-02-15  
15 cm / 6"  
4 X 5 Teeth

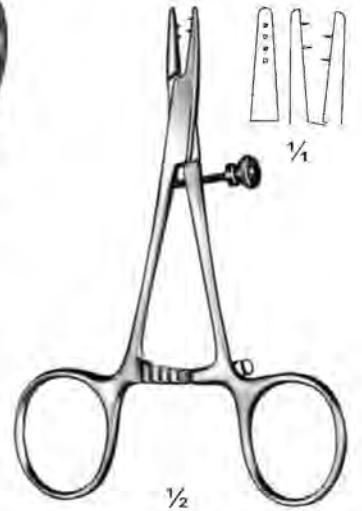

432-03-13  
13 cm / 5 1/8"



432-04-15  
15 cm / 6"

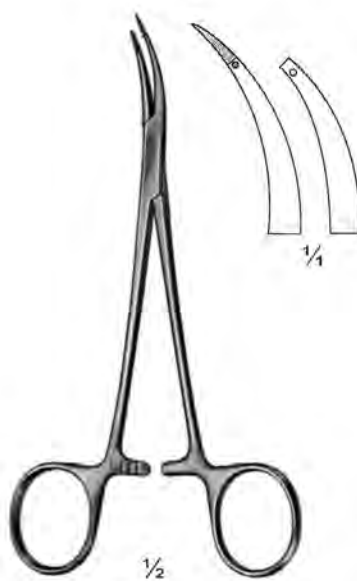

432-05-15  
15 cm / 6"

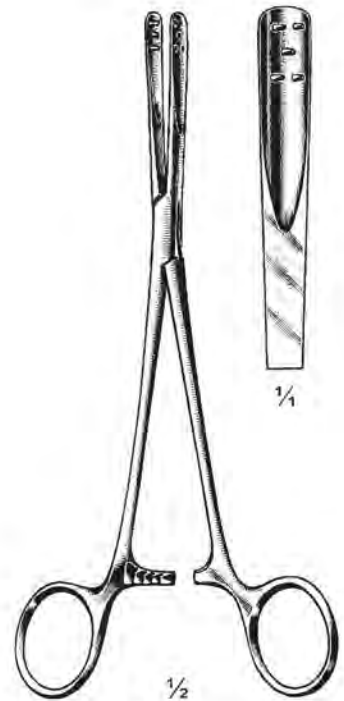

Brand  
432-06-18  
18 cm / 7"



**Flachmeißel, Osteotome, Hohlmeißel ; Cinceles, gubias, osteótomos  
BoneChisels , Gouges& Os teomes; Skalpelli, sgorbie, osteotomi  
Ciseaux-burins ,Ostéomes , Gouges ; Formãos, goivas e osteotómos**

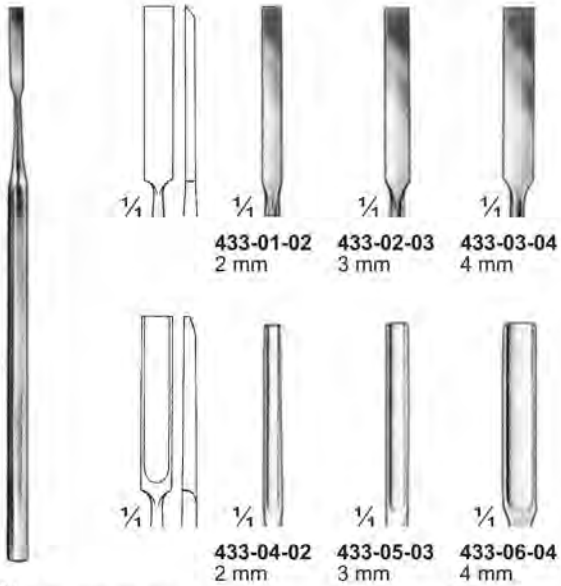

**Buckley**  
433-01-02 To 433-06-04  
16 cm / 6 1/4"

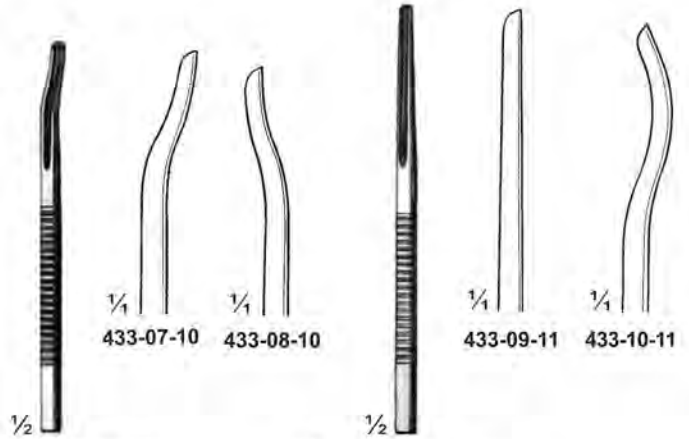

**433-07-10 & 433-08-10**  
10 cm / 4"

**Buck-Gramcko**  
433-09-11 & 433-10-11  
11 cm / 4 1/4"

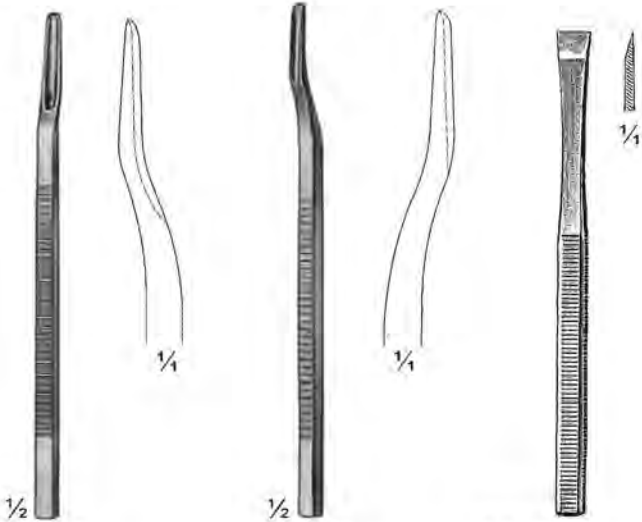

**433-11-13**  
13.5 cm / 5 1/4"

**433-12-13**  
13.5 cm / 5 1/4"

**Schwartz**  
433-13-02 2 mm  
433-14-04 4 mm  
433-15-06 6 mm  
433-16-08 8 mm  
433-17-10 10 mm  
11 cm / 4 1/4"

**Schwartz**  
433-18-02 2 mm  
433-19-04 4 mm  
433-20-06 6 mm  
433-21-08 8 mm  
433-22-10 10 mm  
11 cm / 4 1/4"

**Trautmann**  
433-23-02 2 mm  
433-24-04 4 mm  
433-25-06 6 mm  
433-26-08 8 mm  
433-27-10 10 mm  
11 cm / 4 1/4"

**Bishop**  
433-28-02 2 mm  
433-29-04 4 mm  
433-30-06 6 mm  
433-31-08 8 mm  
433-32-10 10 mm  
11 cm / 4 1/4"



Flachmeißel, Osteotome, Hohlmeißel ; Cinceles, gubias, osteótomos  
 BoneChisels , Gouges & Os teomes; Skalpelli, sgorbie, osteotomi  
 Ciseaux-burins ,Ostéomes , Gouges ; Formãos, goivas e osteotómos



434-01-02 2 mm  
 434-02-03 3 mm  
 434-03-04 4 mm  
 434-04-05 5 mm  
 434-05-06 6 mm  
 434-06-07 7 mm  
 13 cm / 5 1/8"



434-07-02 2 mm  
 434-08-03 3 mm  
 434-09-04 4 mm  
 434-10-05 5 mm  
 434-11-06 6 mm  
 434-12-07 7 mm  
 434-13-08 8 mm  
 434-14-09 9 mm  
 13 cm / 5 1/8"



Bishop  
 434-15-02 2 mm  
 434-16-03 3 mm  
 434-17-04 4 mm  
 434-18-05 5 mm  
 434-19-06 6 mm  
 434-20-08 8 mm  
 15 cm / 6"



Bishop  
 434-21-02 2 mm  
 434-22-03 3 mm  
 434-23-04 4 mm  
 434-24-05 5 mm  
 434-25-06 6 mm  
 15 cm / 6"



Bishop  
 434-26-03 3 mm  
 434-27-04 4 mm  
 434-28-05 5 mm  
 17 cm / 6 3/4"

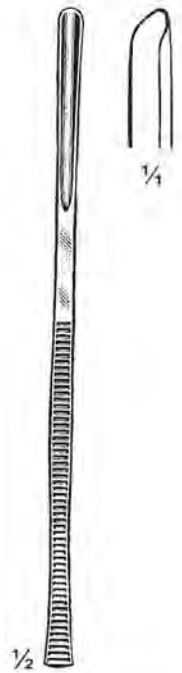

Bishop  
 434-29-03 3 mm  
 434-30-04 4 mm  
 434-31-05 5 mm  
 17 cm / 6 3/4"



434-32-08 To 434-36-16  
 13.5 cm / 5 1/4"

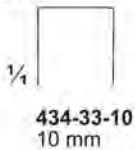
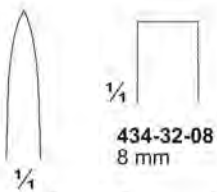

434-33-10  
 10 mm

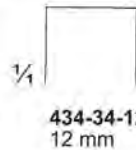

434-34-12  
 12 mm

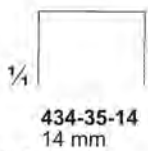

434-35-14  
 14 mm

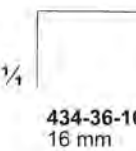

434-36-16  
 16 mm



434-37-08 To 434-41-16  
 13.5 cm / 5 1/4"

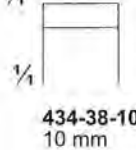
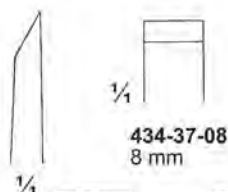

434-38-10  
 10 mm

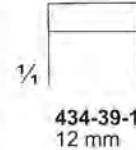

434-39-12  
 12 mm

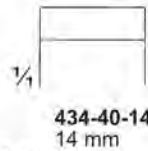

434-40-14  
 14 mm

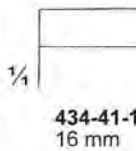

434-41-16  
 16 mm



434-42-08 To 434-46-16  
 13.5 cm / 5 1/4"

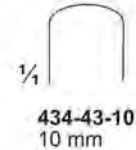
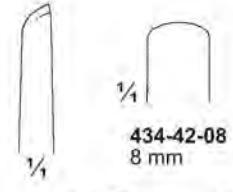

434-43-10  
 10 mm

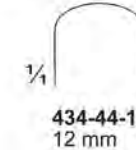

434-44-12  
 12 mm

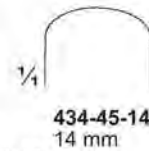

434-45-14  
 14 mm

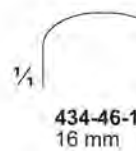

434-46-16  
 16 mm



**Flachmeißel, Osteotome, Hohlmeißel ; Cinceles, gubias, osteótomos  
BoneChisels , Gouges & Os teomes; Skalpelli, sgorbie, osteotomi  
Ciseaux-burins ,Ostéomes , Gouges ; Formãos, goivas e osteotómos**

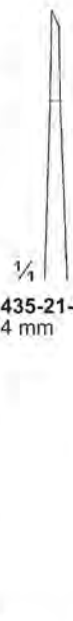
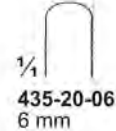
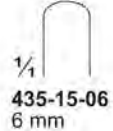
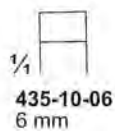
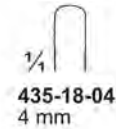
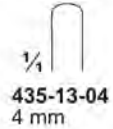
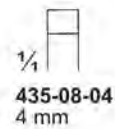
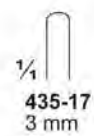
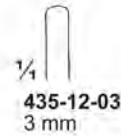
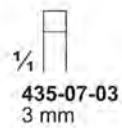
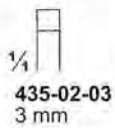
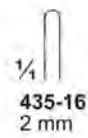
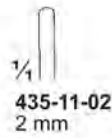
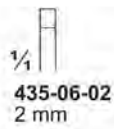
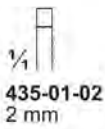

Partsch  
435-01-02 To 435-05-06  
13.5 cm / 5 1/4"

Partsch  
435-06-02 To 435-10-06  
17 cm / 6 3/4"

435-11-02 To 435-15-06  
13.5 cm / 5 1/4"

435-16-02 To 435-20-06  
17 cm / 5 1/4"

Freer  
435-21-04 & 435-22-04  
16 cm / 6 1/4"



Sheehan  
435-23-02 To 435-26-06  
16 cm / 6 1/4"

Freer  
435-27-06  
15 cm / 6"

Mannerfelt modif.  
435-28-04 4 mm  
435-29-06 6 mm  
435-30-07 7 mm  
15 cm / 6"

Mannerfelt modif.  
435-31-03  
15 cm / 6"

West  
435-32-04  
16 cm / 6 1/4"  
4 mm

West  
435-33-04  
16 cm / 6 1/4"  
4 mm



**Flachmeißel, Osteotome, Hohlmeißel ; Cinceles, gubias, osteótomos  
 BoneChisels , Gouges & Os teomes; Skalpelli, sgorbie, osteotomi  
 Ciseaux-burins ,Ostéomes , Gouges ; Formãos, goivas e osteotómos**

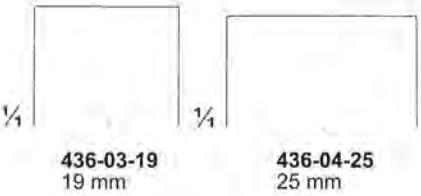
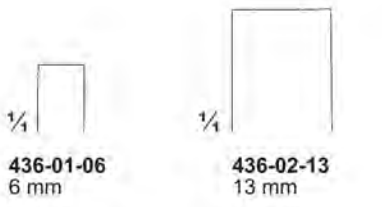

Hibbs  
**436-01-06 To 436-05-32**  
 24 cm / 9½"

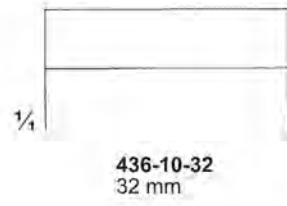
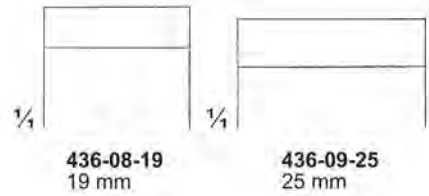
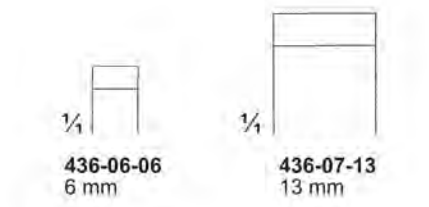

Hibbs  
**436-06-06 To 436-10-32**  
 24 cm / 9½"

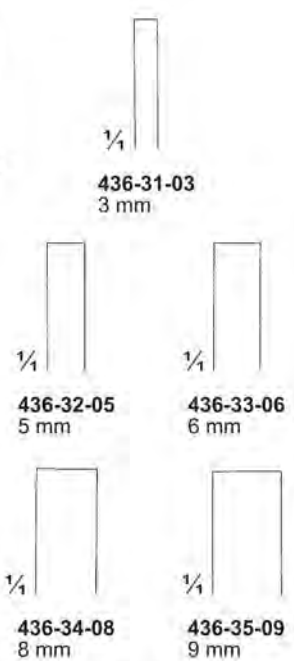
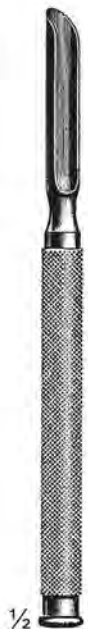

Bruenings (Lucas)  
**436-11-04** 4 mm  
**436-12-06** 6 mm  
**436-13-08** 8 mm  
**436-14-10** 10 mm  
 16 cm / 6¼"

Bruenings (Lucas)  
**436-15-04** 4 mm  
**436-16-06** 6 mm  
**436-17-08** 8 mm  
**436-18-10** 10 mm  
 16 cm / 6¼"

Hoke  
**436-19-03** 3 mm  
**436-20-04** 4.5 mm  
**436-21-06** 6 mm  
**436-22-08** 8 mm  
**436-23-10** 10 mm  
**436-24-12** 12 mm  
 14 cm / 5½"

Hoke  
**436-25-03** 3 mm  
**436-26-04** 4.5 mm  
**436-27-06** 6 mm  
**436-28-08** 8 mm  
**436-29-10** 10 mm  
**436-30-12** 12 mm  
 14 cm / 5½"

Hoke  
**436-31-03 To 436-35-09**  
 17 cm / 6¾"

**Flachmeißel, Osteotome, Hohlmeißel ; Cinceles, gubias, osteótomos  
BoneChisels , Gouges & Os teomes; Skalpelli, sgorbie, osteotomi  
Ciseaux-burins ,Ostéomes , Gouges ; Formãos, goivas e osteotómos**

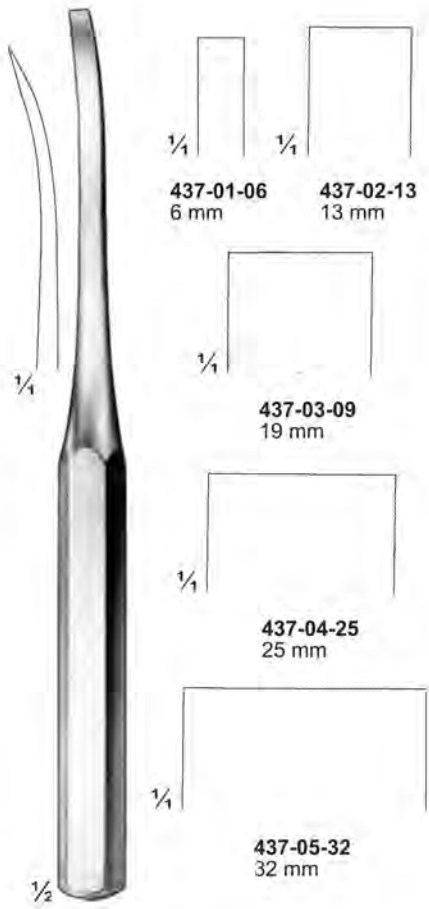

437-01-06 6 mm  
437-02-13 13 mm

437-03-09 19 mm

437-04-25 25 mm

437-05-32 32 mm

Hibbs  
437-01-06 To 437-05-32  
24 cm / 9 1/2"

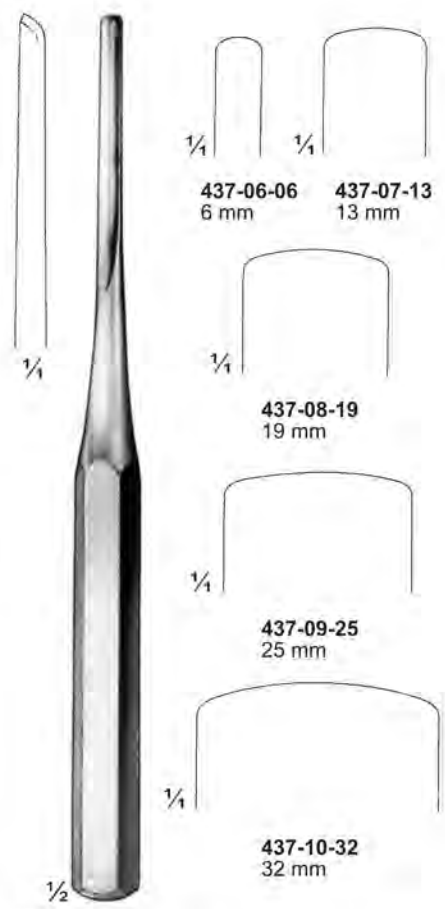

437-06-06 6 mm  
437-07-13 13 mm

437-08-19 19 mm

437-09-25 25 mm

437-10-32 32 mm

Hibbs  
437-06-06 To 437-10-32  
24 cm / 9 1/2"

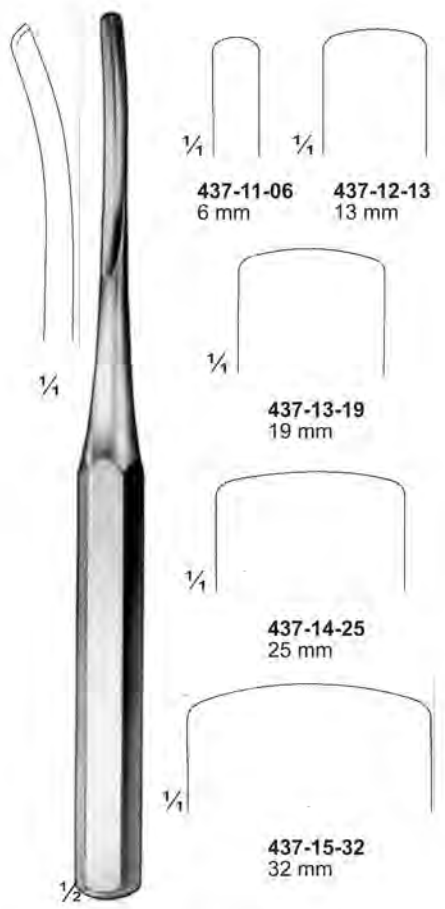

437-11-06 6 mm  
437-12-13 13 mm

437-13-19 19 mm

437-14-25 25 mm

437-15-32 32 mm

Hibbs  
437-11-06 To 437-15-32  
24 cm / 9 1/2"



Kramer  
437-16-02  
21.5 cm / 8 1/2"

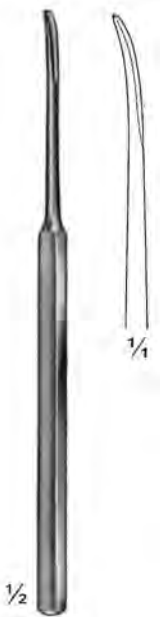

Thies  
437-17-02 2 mm  
437-18-03 3 mm  
437-19-04 4 mm  
16 cm / 6 1/4"

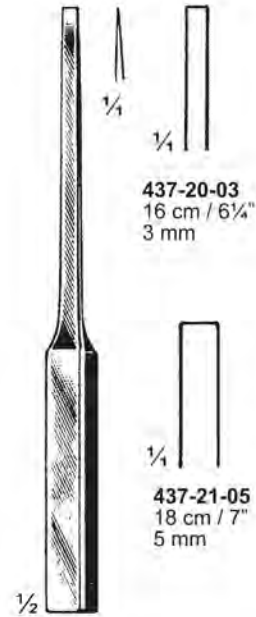

Moberg  
437-20-03 & 438-21-05

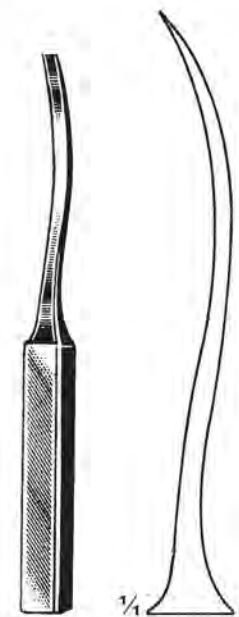

Moberg  
437-22-04  
16 cm / 6 1/4"



**Flachmeißel, Osteotome, Hohlmeißel ; Cinceles, gubias, osteótomos  
 BoneChisels , Gouges & Os teomes; Skalpelli, sgorbie, osteotomi  
 Ciseaux-burins ,Ostéomes , Gouges ; Formãos, goivas e osteotómos**

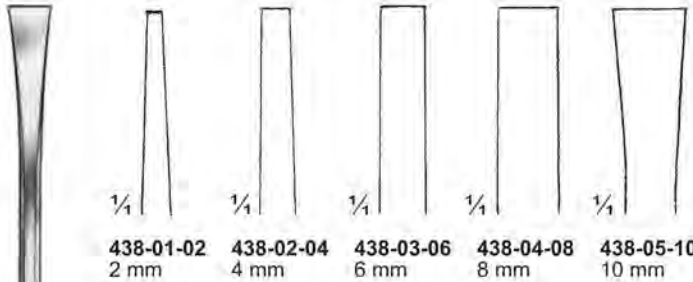

**438-01-02** 2 mm    **438-02-04** 4 mm    **438-03-06** 6 mm    **438-04-08** 8 mm    **438-05-10** 10 mm

1/2

**Sheehan**  
**438-01-02 To 438-08-18**  
 16 cm / 6 1/4"

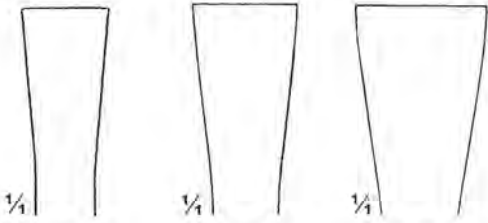

**438-06-12** 12 mm    **438-07-15** 15 mm    **438-08-18** 18 mm



**Lucas**  
**438-09-04** 4 mm  
**438-10-06** 6 mm  
 16 cm / 6 1/4"



**Lucas**  
**438-11-03** 3 mm  
**438-12-05** 5 mm  
 16 cm / 6 1/4"



**Cottle**  
**438-13-04** 4 mm  
**438-14-06** 6 mm  
**438-15-08** 8 mm  
**438-16-10** 10 mm  
**438-17-12** 12 mm  
 18 cm / 7"



**Cottle**  
**438-18-04** 4 mm  
**438-19-07** 7 mm  
**438-20-09** 9 mm  
**438-21-12** 12 mm  
 18 cm / 7"

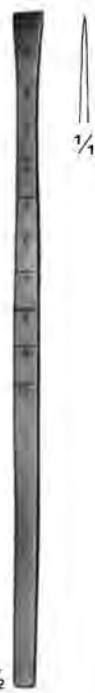

**Cottle**  
**438-22-08** 8 mm  
 18 cm / 7"



**Murphy**  
**438-23-30** 30 mm  
**438-24-40** 40 mm  
 16 cm / 6 1/4"



**Murphy**  
**438-25-30** 30 mm  
**438-26-40** 40 mm  
 16 cm / 6 1/4"

**Flachmeißel, Osteotome, Hohlmeißel ; Cinceles, gubias, osteótomos  
BoneChisels , Gouges & Os teomes; Skalpelli, sgorbie, osteotomi  
Ciseaux-burins ,Ostéomes , Gouges ; Formãos, goivas e osteotómos**

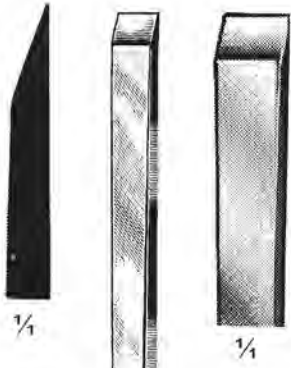

U. S. Army  
439-01-06 6 mm  
439-02-12 12 mm  
439-03-18 18 mm  
16 cm / 6 1/4"

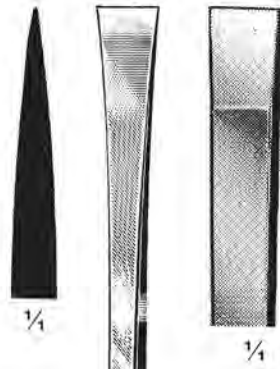

U. S. Army  
439-04-06 6 mm  
439-05-12 12 mm  
439-06-18 18 mm  
16 cm / 6 1/4"

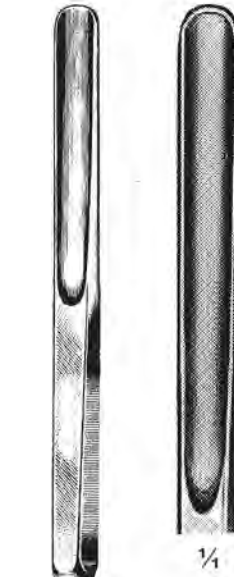

U. S. Army  
439-07-06 6 mm  
439-08-12 12 mm  
439-09-18 18 mm  
16 cm / 6 1/4"



Lambotte  
439-10-04 4 mm  
439-11-06 6 mm  
439-12-08 8 mm  
439-13-10 10 mm  
439-14-12 12 mm  
439-15-15 15 mm  
12.5 cm / 5"

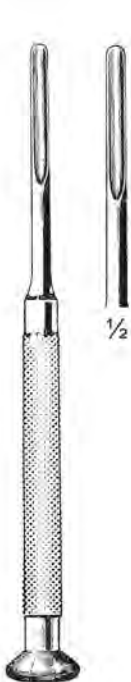

439-16-03 3 mm  
439-17-04 4 mm  
439-18-05 5 mm  
439-19-06 6 mm  
439-20-08 8 mm  
16 cm / 6 1/4"



Alexander  
439-21-04 To 439-26-14  
18 cm / 7"

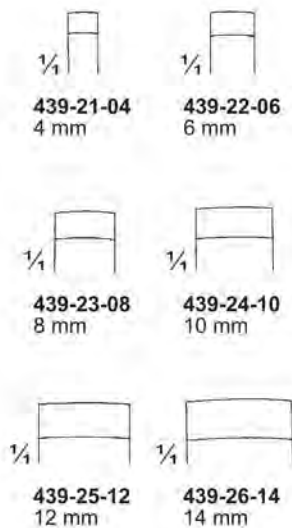

Alexander  
439-27-04 To 439-32-14  
18 cm / 7"

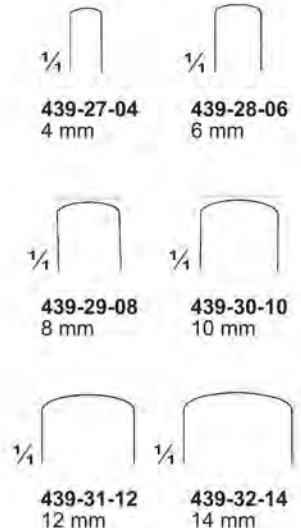





Flachmeißel, Osteotome, Hohlmeißel ; Cinceles, gubias, osteótomos  
 BoneChisels , Gouges & Os teomes; Skalpelli, sgorbie, osteotomi  
 Ciseaux-burins ,Ostéomes , Gouges ; Formãos, goivas e osteotómos

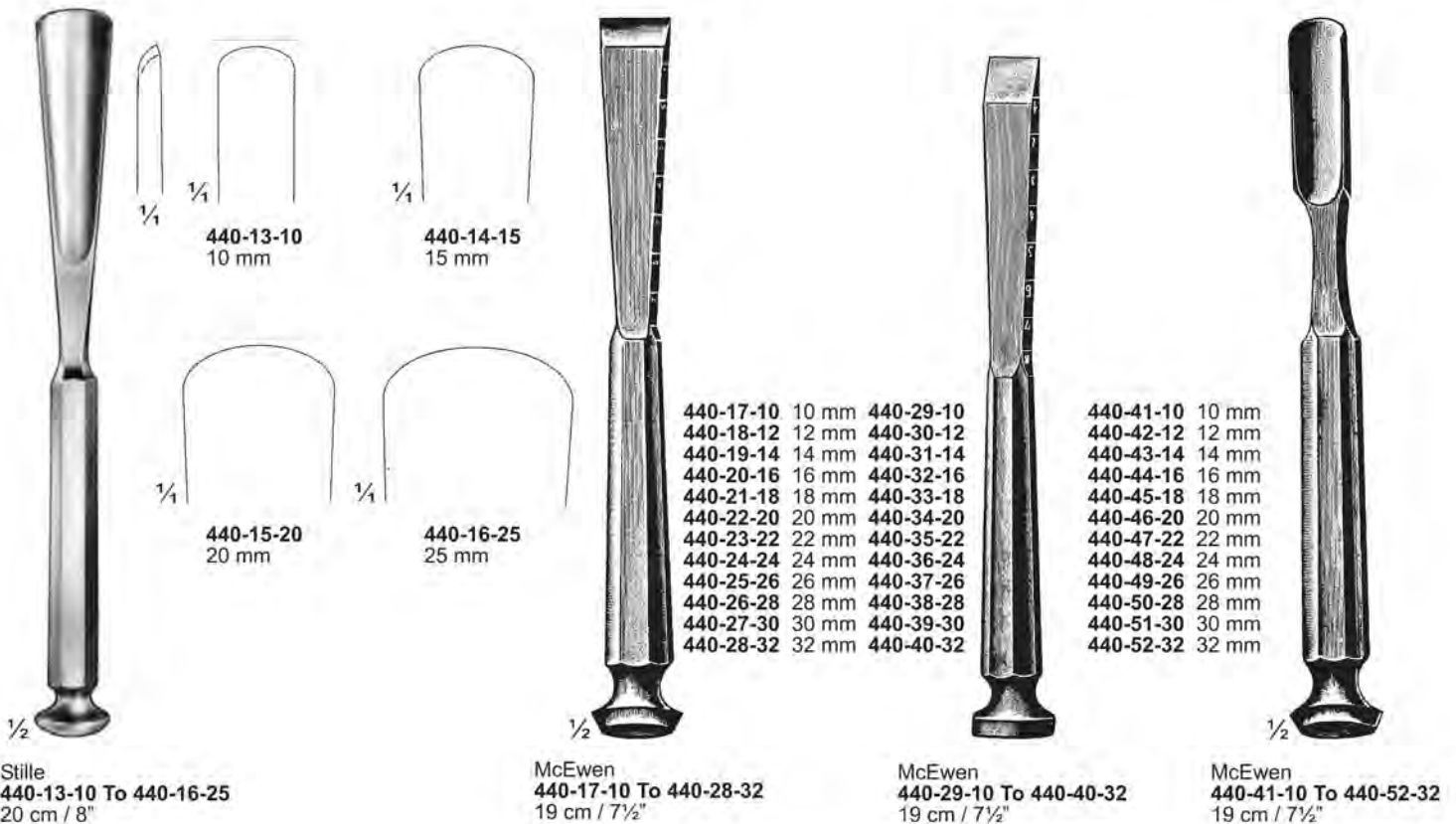
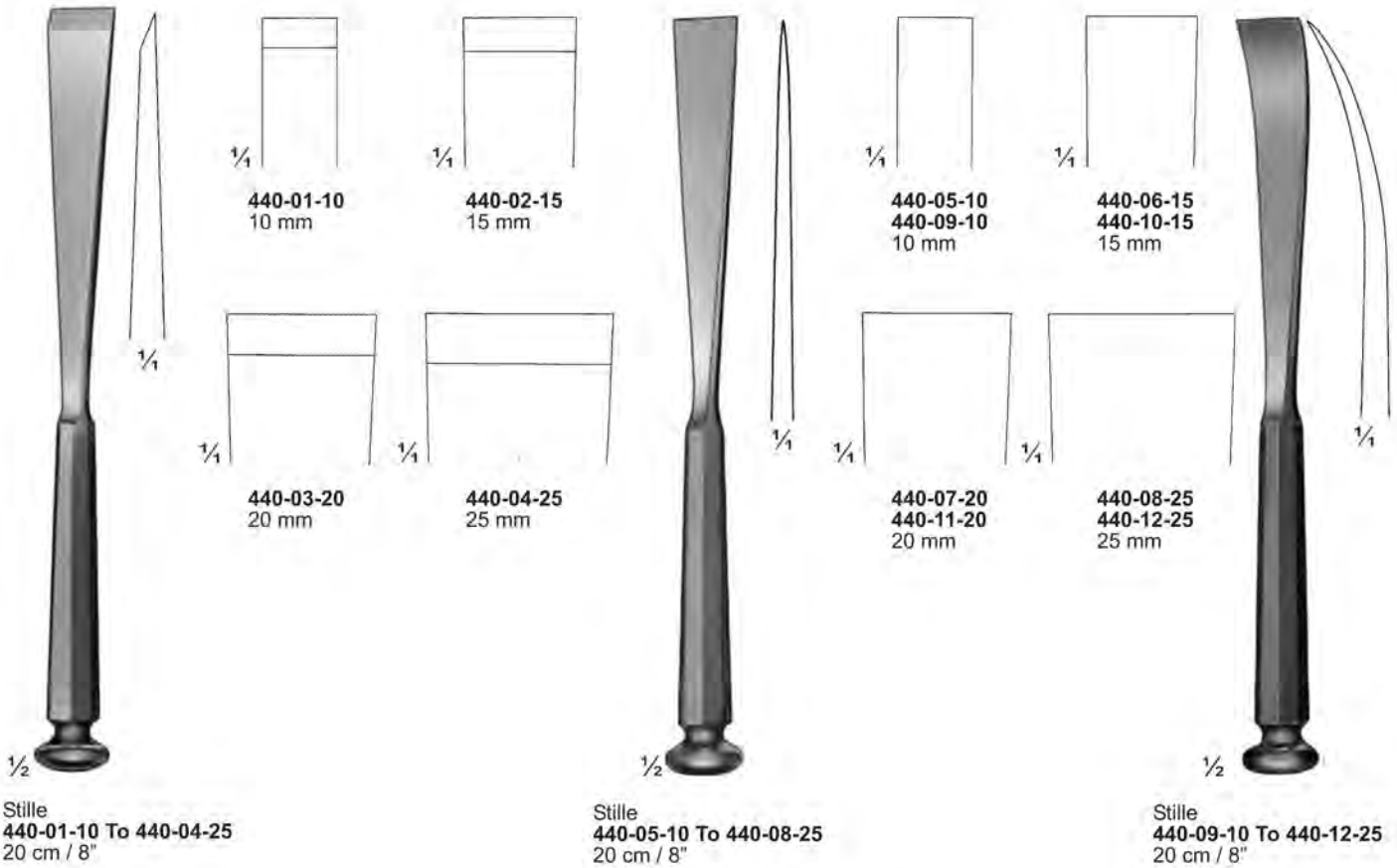

Flachmeißel, Osteotome, Hohlmeißel ; Cinceles, gubias, osteótomos  
 BoneChisels , Gouges & Os teomes; Skalpelli, sgorbie, osteotomi  
 Ciseaux-burins ,Ostéomes , Gouges ; Formãos, goivas e osteotómos



- |           |       |           |
|-----------|-------|-----------|
| 441-01-06 | 6 mm  | 441-14-06 |
| 441-02-08 | 8 mm  | 441-15-08 |
| 441-03-10 | 10 mm | 441-16-10 |
| 441-04-12 | 12 mm | 441-17-12 |
| 441-05-14 | 14 mm | 441-18-14 |
| 441-06-16 | 16 mm | 441-19-16 |
| 441-07-18 | 18 mm | 441-20-18 |
| 441-08-20 | 20 mm | 441-21-20 |
| 441-09-22 | 22 mm | 441-22-22 |
| 441-10-24 | 24 mm | 441-23-24 |
| 441-11-26 | 26 mm | 441-24-26 |
| 441-12-28 | 28 mm | 441-25-28 |
| 441-13-30 | 30 mm | 441-26-30 |

Bergmann  
 441-01-06 To 441-13-30  
 20 cm / 8"



Bruns  
 441-14 To 441-26  
 19 cm / 7 1/2"



Bruns  
 441-27-06 To 441-39-30  
 19 cm / 7 1/2"



Bruns  
 441-40-06 To 441-52-30  
 19 cm / 7 1/2"



Walter  
 441-53-10 10 mm  
 441-54-15 15 mm  
 20 cm / 8"



- |           |                |
|-----------|----------------|
| 441-55-06 | 6 mm           |
| 441-56-08 | 8 mm           |
| 441-57-10 | 10 mm          |
| 441-58-12 | 12 mm          |
|           | 16 cm / 6 1/4" |



- |           |                |
|-----------|----------------|
| 441-59-06 | 6 mm           |
| 441-60-08 | 8 mm           |
| 441-61-10 | 10 mm          |
| 441-62-12 | 12 mm          |
|           | 16 cm / 6 1/4" |



441-63-22  
 22 cm / 8 3/4"



441-64-20  
 20 cm / 8"



- |           |                  |
|-----------|------------------|
| 441-65-15 | 15 mm            |
| 441-66-18 | 18 mm            |
| 441-67-22 | 22 mm            |
|           | 13.5 cm / 5 1/4" |

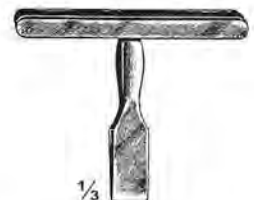

Virchow  
 441-68-07  
 7.5 cm / 3"

**Flachmeißel, Osteotome, Hohlmeißel ; Cinceles, gubias, osteótomos  
BoneChisels , Gouges & Os teomes; SkalPELLi, sgorbie, osteotomi  
Ciseaux-burins ,Ostéomes , Gouges ; Formãos, goivas e osteotómos**



1/2  
Smith-Petersen  
442-01-06 To 442-07-32  
20 cm / 8"

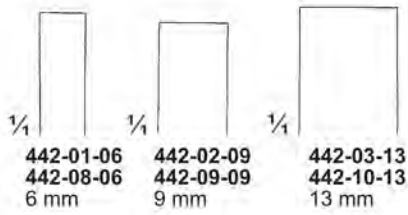

1/4 1/4 1/4  
442-01-06 442-02-09 442-03-13  
442-08-06 442-09-09 442-10-13  
6 mm 9 mm 13 mm

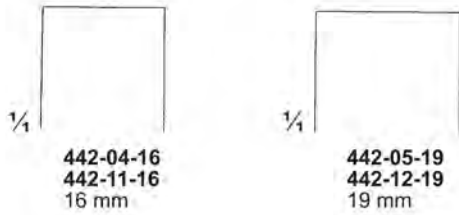

1/4 1/4  
442-04-16 442-05-19  
442-11-16 442-12-19  
16 mm 19 mm

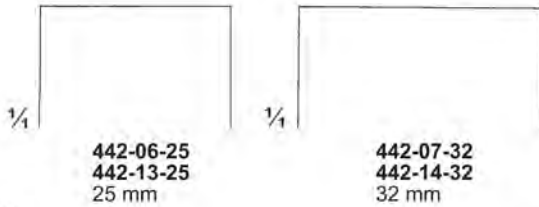

1/4 1/4  
442-06-25 442-07-32  
442-13-25 442-14-32  
25 mm 32 mm



1/2  
Smith-Petersen  
442-08-06 To 442-14-32  
20 cm / 8"



1/3  
Brunetti  
442-15-28  
28 cm / 11"



1/3  
Brunetti  
442-16-28  
28 cm / 11"



1/2  
Smith-Petersen  
442-17-06 To 442-23-32  
20 cm / 8"

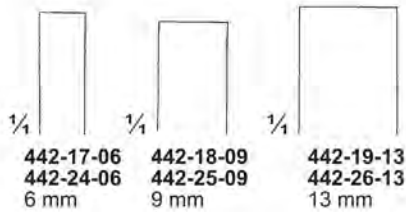

1/4 1/4 1/4  
442-17-06 442-18-09 442-19-13  
442-24-06 442-25-09 442-26-13  
6 mm 9 mm 13 mm

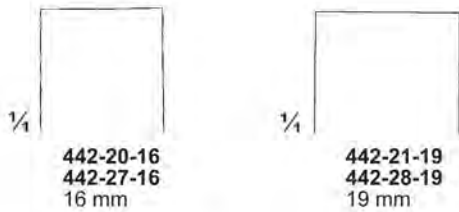

1/4 1/4  
442-20-16 442-21-19  
442-27-16 442-28-19  
16 mm 19 mm

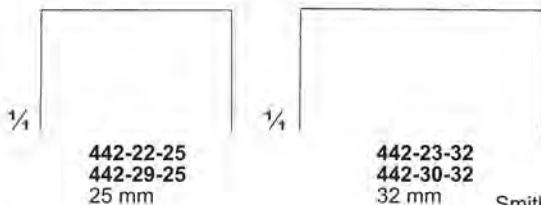

1/4 1/4  
442-22-25 442-23-32  
442-29-25 442-30-32  
25 mm 32 mm



1/2  
Smith-Petersen  
442-24-06 To 442-30-32  
20 cm / 8"



1/2  
Mini-Lambotte  
442-31-03 To 442-37-15  
12.5 cm / 5"

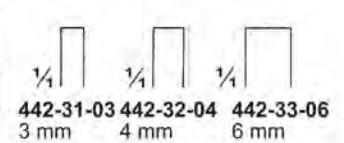

1/4 1/4 1/4  
442-31-03 442-32-04 442-33-06  
3 mm 4 mm 6 mm

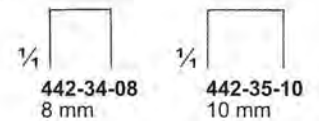

1/4 1/4  
442-34-08 442-35-10  
8 mm 10 mm

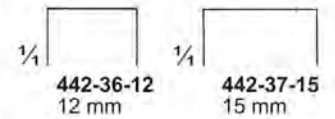

1/4 1/4  
442-36-12 442-37-15  
12 mm 15 mm



Flachmeißel, Osteotome, Hohlmeißel ; Cinceles, gubias, osteótomos  
 BoneChisels , Gouges & Os teomes; Skalpelli, sgorbie, osteotomi  
 Ciseaux-burins ,Ostéomes , Gouges ; Formãos, goivas e osteotómos

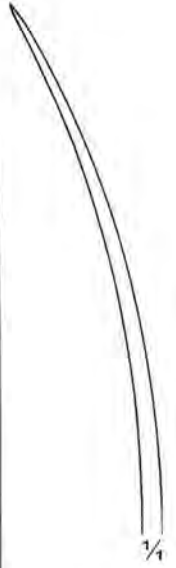
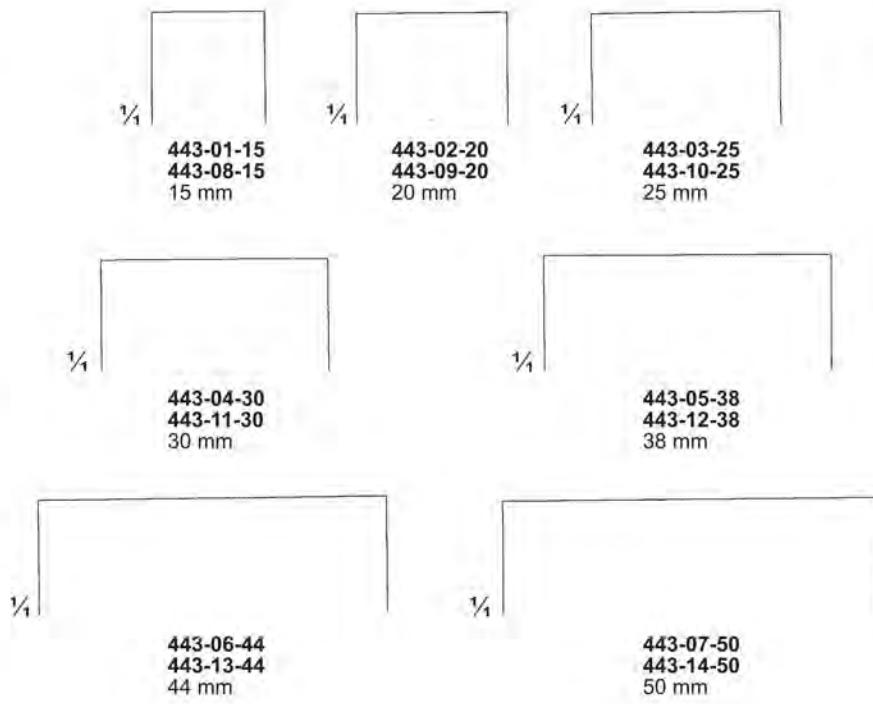

Lambotte  
 443-01-15 To 443-07-50  
 24.5 cm / 9 3/4"

Lambotte  
 443-08-15 To 443-14-50  
 24.5 cm / 9 3/4"

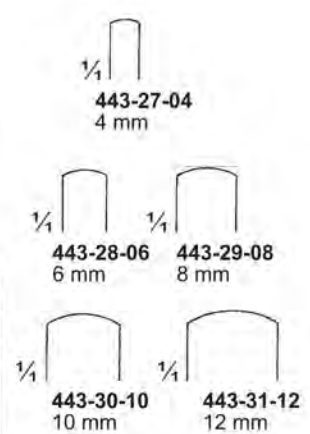
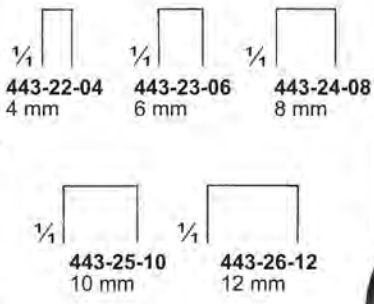
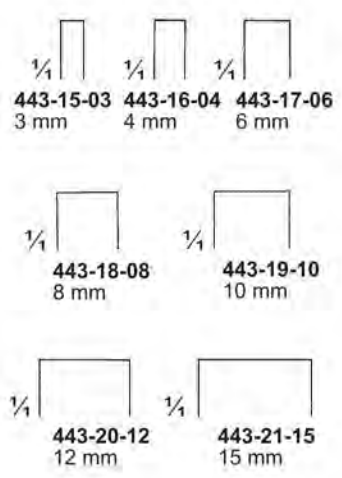

Mini-Lambotte  
 443-15-03 To 443-21-15  
 24.5 cm / 9 3/4"

Mini-Lexer  
 443-22-04 To 443-26-12  
 18 cm / 7"

Mini-Lexer  
 443-27-04 To 443-31-12  
 18 cm / 7"



**Flachmeißel, Osteotome, Hohlmeißel ; Cinceles, gubias, osteótomos  
 BoneChisels , Gouges & Os teomes; Skalpelli, sgorbie, osteotomi  
 Ciseaux-burins ,Ostéomes , Gouges ; Formãos, goivas e osteotómos**

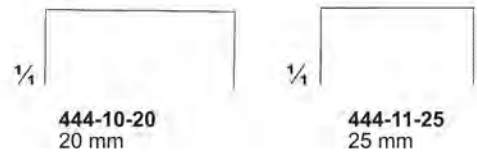
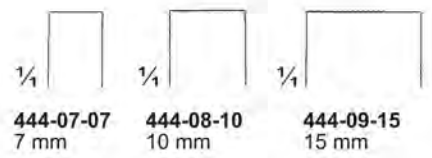
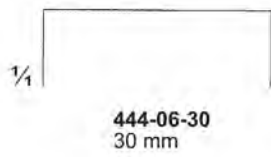
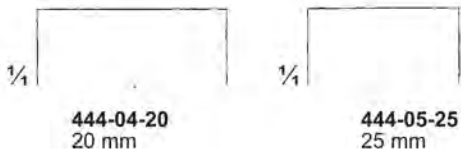
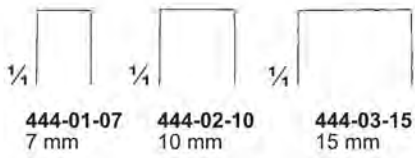

Lexer  
**444-01-07 To 444-06-30**  
 22 cm / 8¾"

Lexer  
**444-07-07 To 444-12-30**  
 22 cm / 8¾"

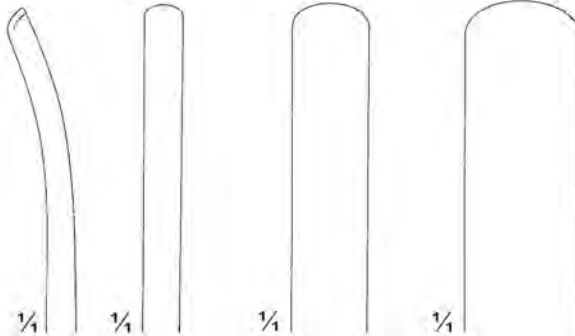
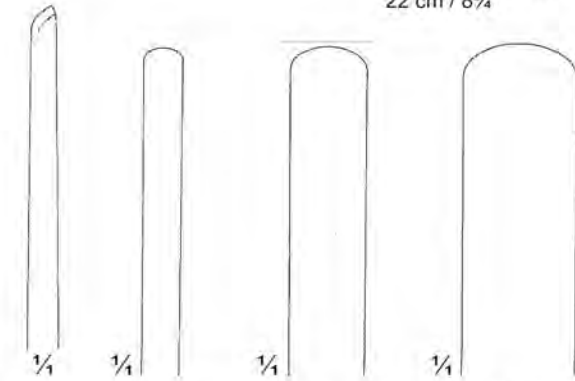

Lexer  
**444-13-05 To 444-18-15**  
 25 cm / 10"

**444-16-05**  
 5 mm

**444-17-10**  
 10 mm

**444-18-15**  
 15 mm



Obwegesser  
**444-19-11** 11 mm  
 23.5 cm / 9¼"

Niederellmann  
**444-20-08** 8 mm  
**444-21-10** 10 mm  
 25 cm / 10"



**Flachmeißel, Osteotome, Hohlmeißel ; Cinceles, gubias, osteótomos  
 BoneChisels , Gouges & Os teomes; Skalpelli, sgorbie, osteotomi  
 Ciseaux-burins ,Ostéomes , Gouges ; Formãos, goivas e osteotómos**



**445-01-10** 10 mm  
**445-02-15** 15 mm  
 16 cm / 6 1/4"

**445-03-10** 10 mm  
**445-04-15** 15 mm  
**445-05-20** 20 mm  
 20 cm / 8"

**445-06-10** 10 mm  
**445-07-15** 15 mm  
**445-08-20** 20 mm  
 20 cm / 8"

**445-09-09** 9 mm  
 22 cm / 8 3/4"



**445-10-18**  
 18 cm / 7"  
 Handle with key for  
 interchangeable blades 445-11-05 to 445-18-25

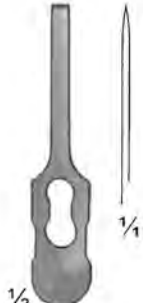

**445-11-05** 5 mm  
**445-12-10** 10 mm  
**445-13-16** 16 mm  
**445-14-25** 25 mm  
 Useable length 45 mm

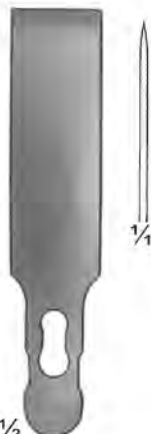

**445-15-78** 25 mm  
 Useable length 78 mm



**445-16-50 To 445-18-70**

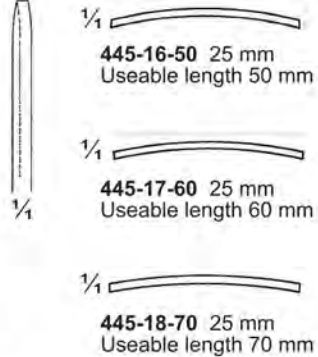

**445-16-50** 25 mm  
 Useable length 50 mm

**445-17-60** 25 mm  
 Useable length 60 mm

**445-18-70** 25 mm  
 Useable length 70 mm

**Flachmeißel, Osteotome, Hohlmeißel ; Cinceles, gubias, osteótomos  
BoneChisels , Gouges & Os teomes; SkalPELLi, sgorbie, osteotomi  
Ciseaux-burins ,Ostéomes , Gouges ; Formãos, goivas e osteotómos**



446-04-09 9 mm  
446-05-15 15 mm  
446-06-30 30 mm  
Str



446-07-09 9 mm  
446-08-15 15 mm  
446-09-30 30 mm  
Inclined forward



446-10-09 9 mm  
446-11-15 15 mm  
446-12-30 30 mm  
Inclined backward



9 mm



15 mm

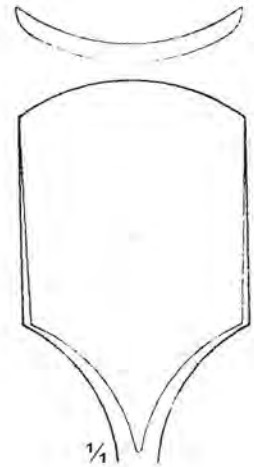

30 mm



Wagner  
446-04-09 To 446-12-30  
34 cm / 13 1/2"  
Thin concave osteotome



446-01-20 20 mm  
24.5 cm / 9 3/4"



Zielke  
446-02-05 5.5 mm  
446-03-09 9 mm  
23 cm / 9"



446-13-05 5 mm  
446-14-10 10 mm  
446-15-15 15 mm  
25 cm / 10"



446-16-05 5 mm  
446-17-10 10 mm  
446-18-15 15 mm  
25 cm / 10"



Flachmeißel, Osteotome, Hohlmeißel ; Cinceles, gubias, osteótomos  
 BoneChisels , Gouges & Os teomes; Skalpelli, sgorbie, osteotomi  
 Ciseaux-burins ,Ostéomes , Gouges ; Formãos, goivas e osteotómos

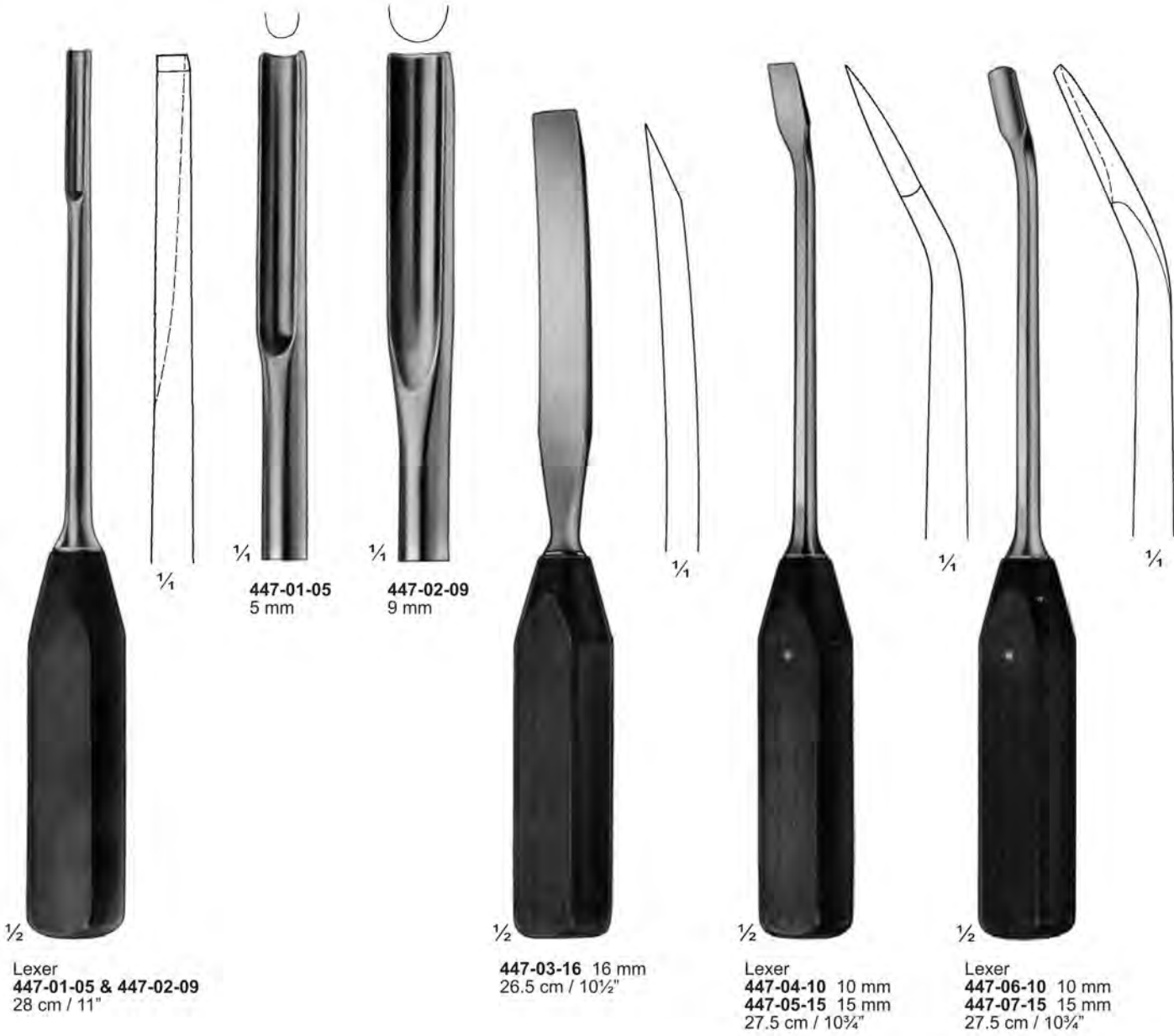

Lexer  
 447-01-05 & 447-02-09  
 28 cm / 11"

447-01-05 5 mm  
 447-02-09 9 mm

447-03-16 16 mm  
 26.5 cm / 10½"

Lexer  
 447-04-10 10 mm  
 447-05-15 15 mm  
 27.5 cm / 10¾"

Lexer  
 447-06-10 10 mm  
 447-07-15 15 mm  
 27.5 cm / 10¾"



# Stößel Tampers Pilons Métalliques

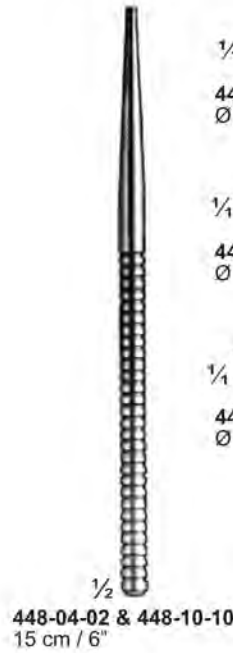
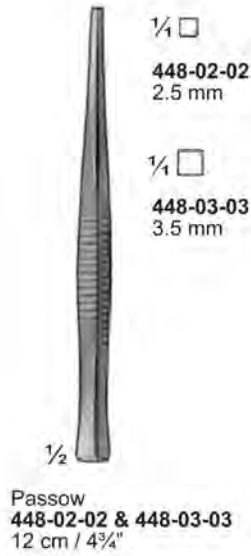
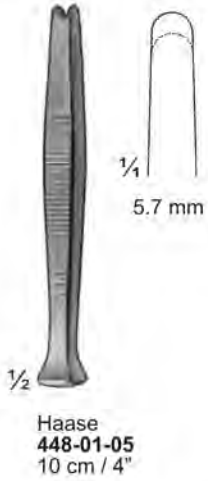

- 1/4 ● 448-04-02 Ø 2 mm
- 1/4 ● 448-05-03 Ø 3 mm
- 1/4 ● 448-06-04 Ø 4 mm
- 1/4 ● 448-07-05 Ø 5 mm
- 1/4 ● 448-08-06 Ø 6 mm
- 1/4 ● 448-09-08 Ø 8 mm

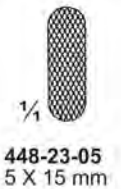

**Raspatorien  
Periosteal Elevators  
Rugines- raspatoires**

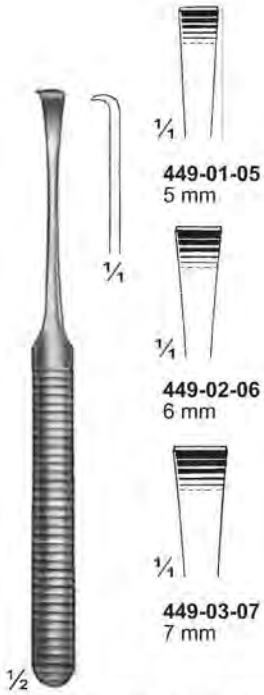

449-01-05 To 449-03-07  
16 cm / 6 1/4"

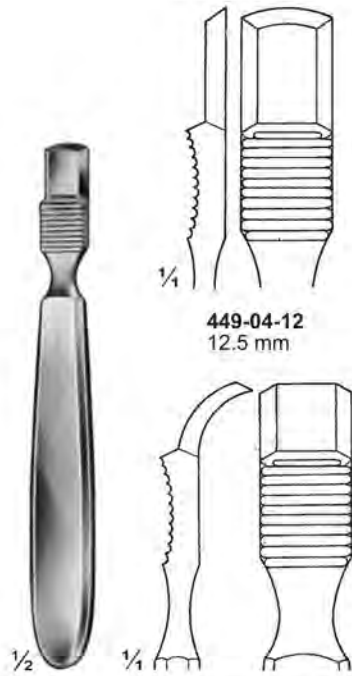

Farabeuf  
449-04-12 & 449-05-12  
14 cm / 5 1/2"

449-05-12  
12.5 mm



Farabeuf-Collin  
449-06-11 & 449-07-11  
16 cm / 6 1/4"

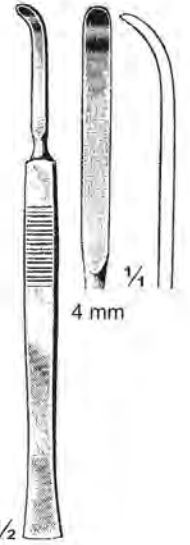
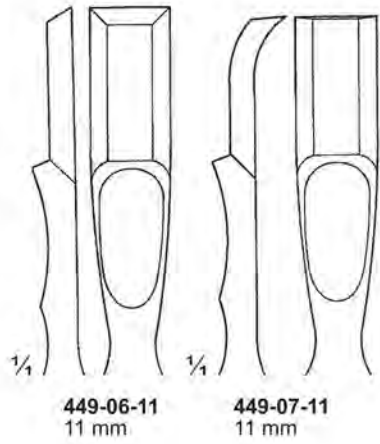

McKenty  
449-08-04  
15 cm / 6"



Lambotte  
449-09-10 To 449-12-25  
21 cm / 8 1/4"

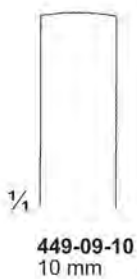

449-09-10  
10 mm

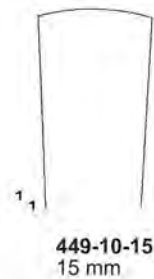

449-10-15  
15 mm

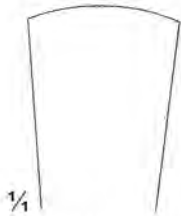

449-11-20  
20 mm

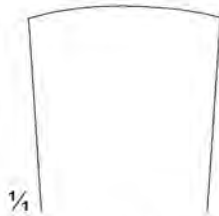

449-12-25  
25 mm



Farabeuf  
449-13-13 & 449-14-13  
15 cm / 6"

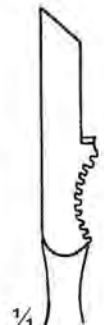

449-13-13  
13 mm



449-14-13  
13 mm



Farabeuf  
449-15-13  
19 cm / 7 1/2"

**Raspatorien  
Periosteal Elevators  
Rugines- raspatoires**

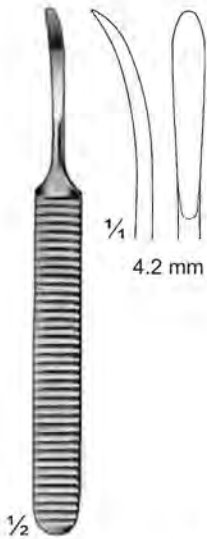

Williger  
450-01-04  
14 cm / 5½"

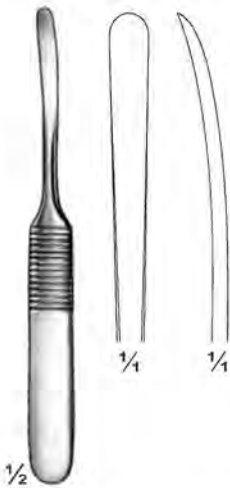

Williger  
450-02-13  
13 cm / 5¼"

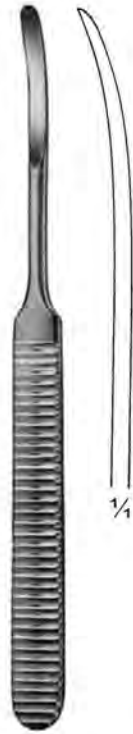

Williger  
450-03-03 To 450-05-07  
16 cm / 6¼"

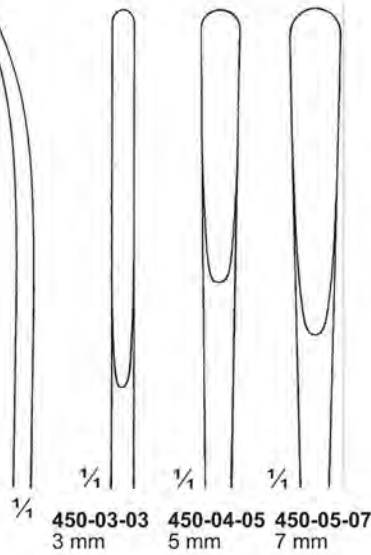

Kahre-Williger  
450-06-04 & 450-07-05  
16 cm / 6¼"

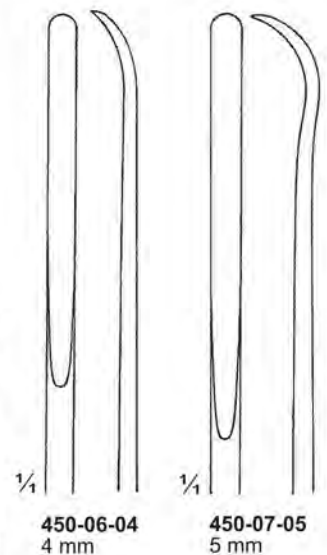

Cushing  
450-08-04 To 450-11-07  
19.5 cm / 7¾"  
5 mm



450-08-04  
17 cm / 6¾"  
4 mm

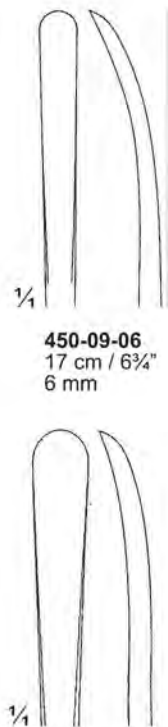

450-09-06  
17 cm / 6¾"  
6 mm



Hoehn  
450-12-07 To 450-14-20

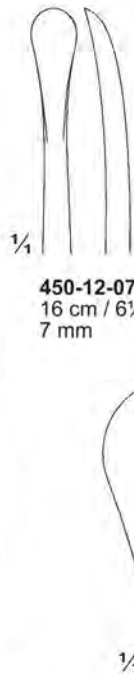

450-12-07  
16 cm / 6¼"  
7 mm

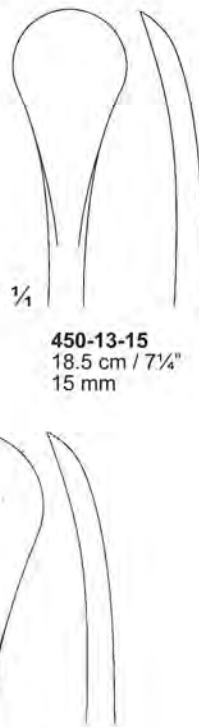

450-14-20  
19 cm / 7½"  
20 mm

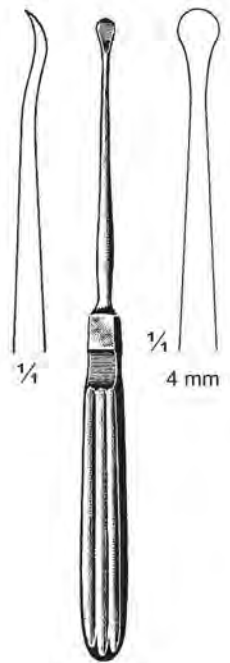

450-15-04  
19 cm / 7½"

**Raspatorien; Legras  
Raspatories; Raspadori  
Raspatoires; Raspadores**

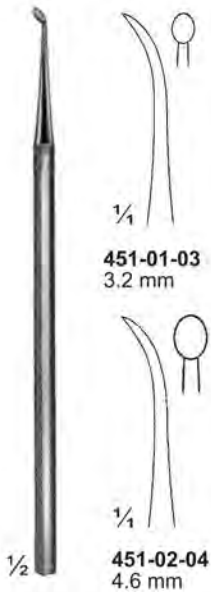

**451-01-03**  
3.2 mm

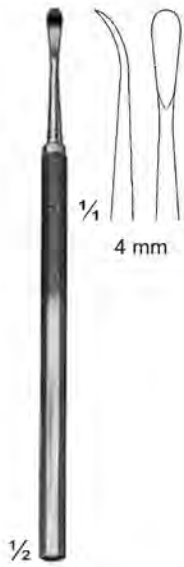

**451-03-04**  
4 mm

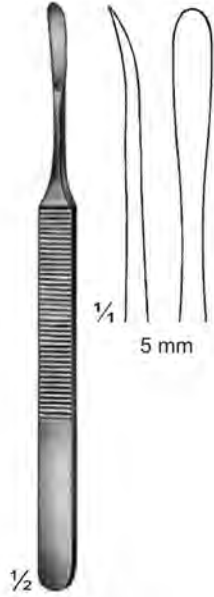

**451-04-05**  
5 mm

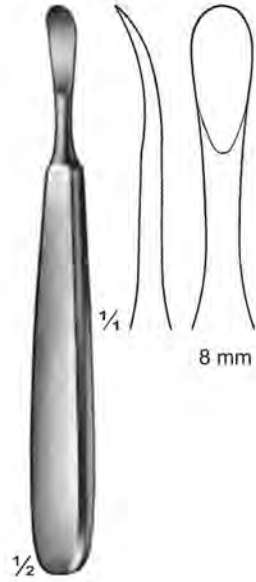

**451-05-08**  
8 mm

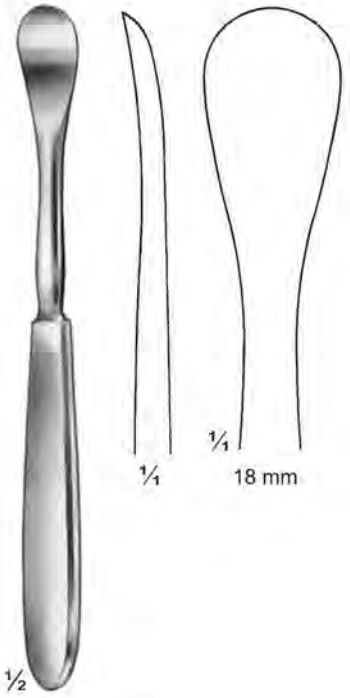

**451-06-18**  
18 mm

**Partsch**  
**451-01-03 & 451-02-04**  
15 cm / 6"

**Partsch Mod. Lange**  
**451-03-04**  
14.5 cm / 5 3/4"

**Koenig**  
**451-04-05**  
15 cm / 6"

**Trelat**  
**451-05-08**  
15 cm / 6"

**Sedillot**  
**451-06-18**  
18.5 cm / 7 1/4"

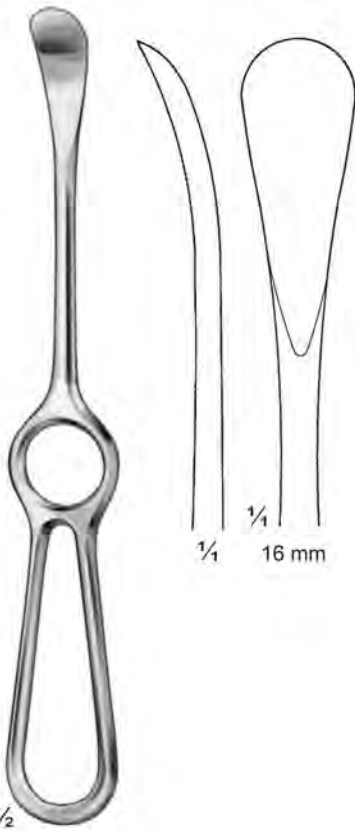

**451-07-16**  
16 mm

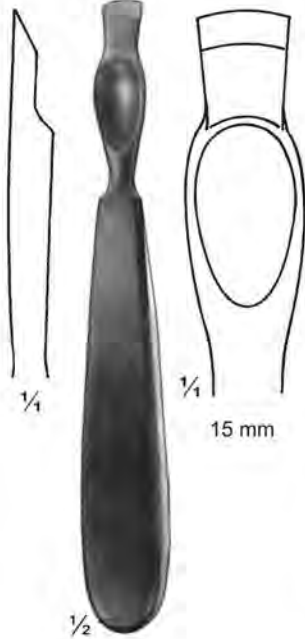

**451-08-15**  
15 mm



**451-09-16**  
**451-13-16**  
19 cm / 7 1/2"  
16 mm

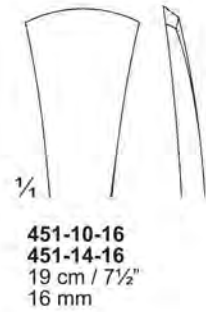

**451-10-16**  
**451-14-16**  
19 cm / 7 1/2"  
16 mm

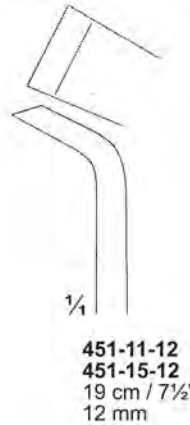

**451-11-12**  
**451-15-12**  
19 cm / 7 1/2"  
12 mm

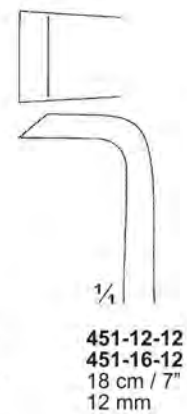

**451-12-12**  
**451-16-12**  
18 cm / 7"  
12 mm

**Sedillot**  
**451-07-16**  
21.5 cm / 8 1/2"

**Kirmission**  
**451-08-15**  
16.5 cm / 6 1/2"

**Langenbeck**  
**451-09-16 To 451-12-12**

**Langenbeck**  
**451-13-16 To 451-16-12**

**Raspatorien; Legras  
Raspatories; Raspadori  
Raspatoires; Raspadores**

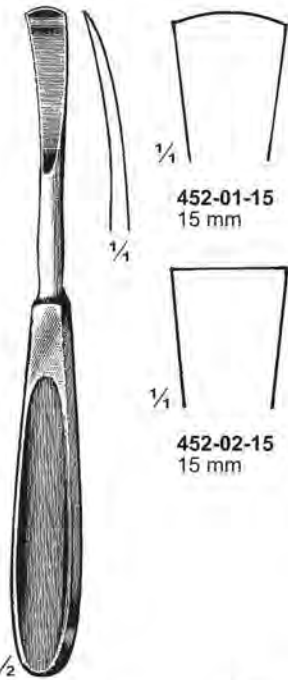

Cushing  
452-01-15 & 452-02-15  
18 cm / 7"

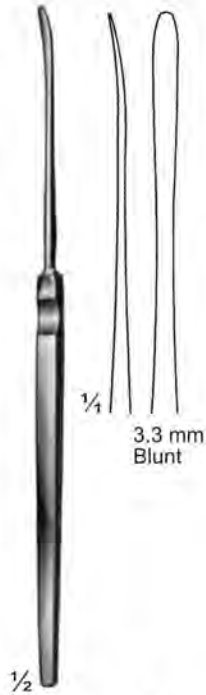

Halle  
452-03-03  
18 cm / 7"



Sewall  
452-04-05  
20 cm / 8"



Freer  
452-05-04  
19 cm / 7 1/2"



Freer  
452-06-04  
19 cm / 7 1/2"



452-07-17  
17 cm / 6 1/2"

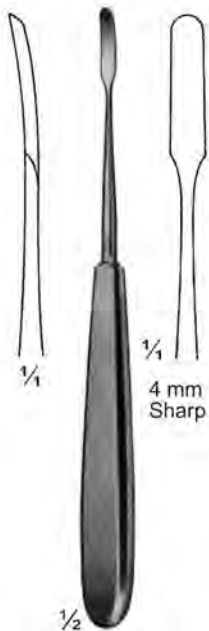

Joseph  
452-08-04  
16.5 cm / 6 1/2"



Molt  
452-09-18  
18 cm / 7"

Molt  
452-10-18  
18 cm / 7"



Molt  
452-11-18  
18 cm / 7"

Molt  
452-12-18  
18 cm / 7"

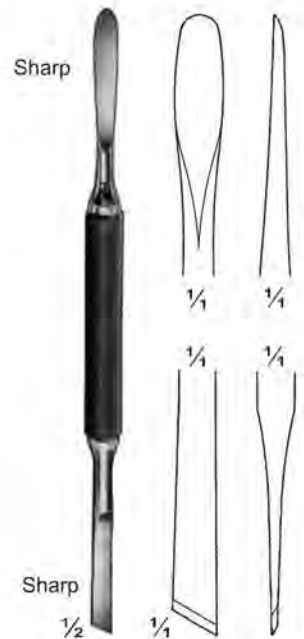

Mead  
452-13-16  
16.5 cm / 6 1/2"



**Raspatorien; Legras  
Raspatories; Raspadori  
Raspatoires; Raspadores**

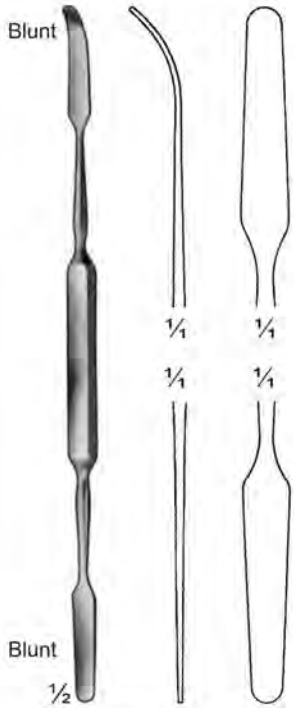

**MacDonald  
453-01-19**  
19 cm / 7 1/2"

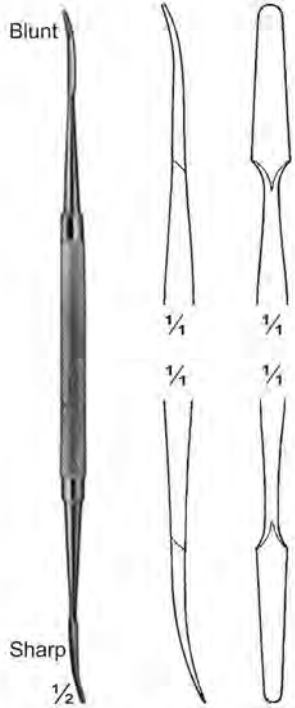

**Killian  
453-02-18**  
18.5 cm / 7 1/4"

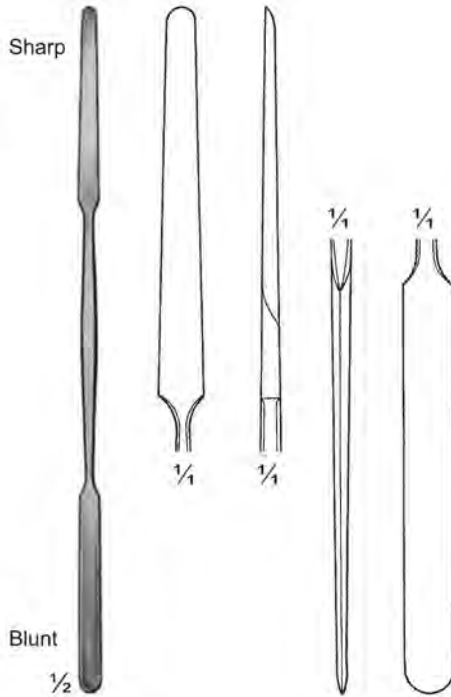

**Killian  
453-03-18**  
18.5 cm / 7 1/4"

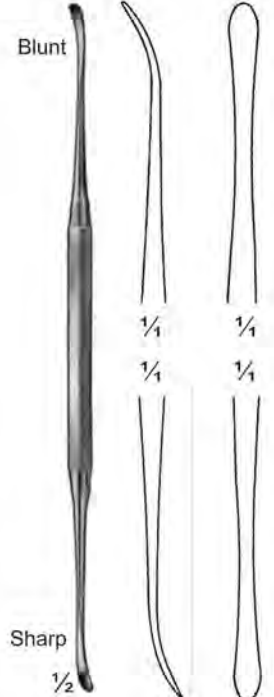

**Freer  
453-04-18**  
18.5 cm / 7 1/4"

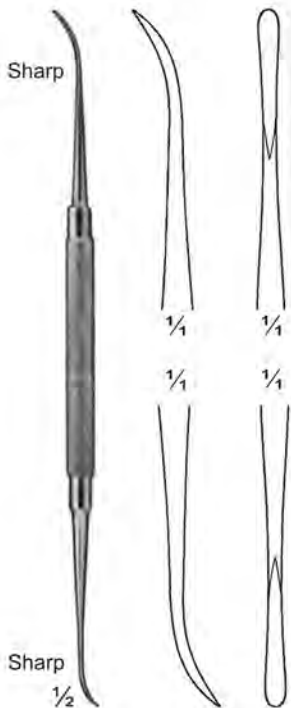

**Freer-Yasargil  
453-05-18**  
18.5 cm / 7 1/4"

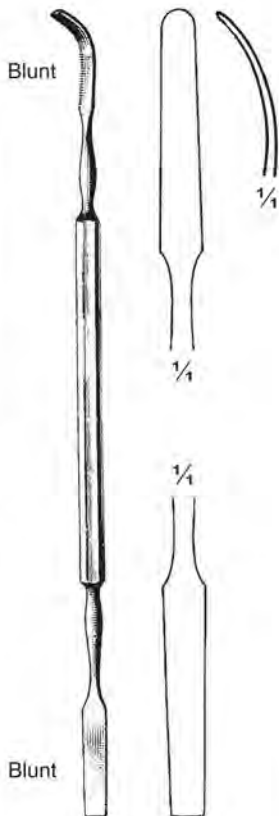

**Cohen  
453-06-24**  
24 cm / 9 1/2"



**Paulsen  
453-07-02 To 453-11-08**  
20 cm / 8"

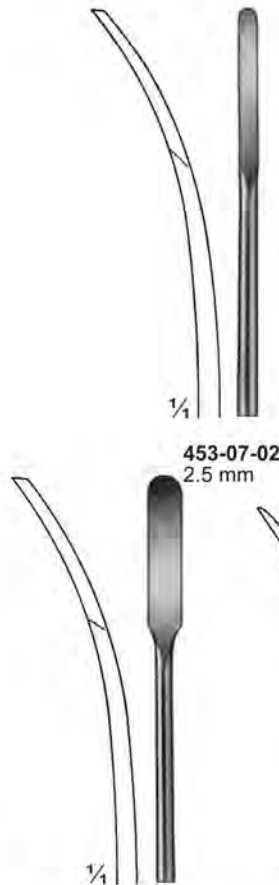

**453-09-04**  
4.5 mm

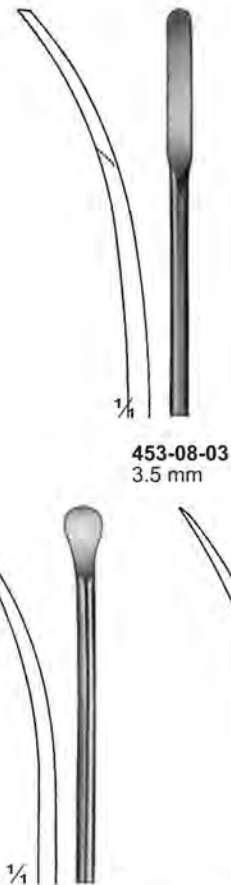

**453-10-05**  
5 mm



**453-11-08**  
8 mm



**Raspatorien; Legras  
Raspatories; Raspadori  
Raspatoires; Raspadores**



1/4  
**455-01-12**  
19 cm / 7 1/2"  
12 mm



1/4  
**455-02-12**  
23 cm / 9"  
12 mm



1/4  
**455-03-13**  
23 cm / 9"  
13 mm

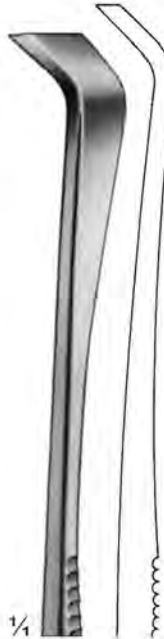

1/4  
**455-04-13**  
23 cm / 9"  
13 mm

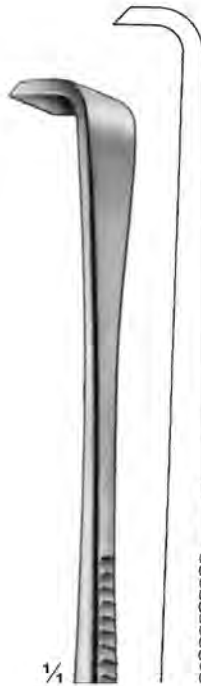

1/4  
**455-05-15**  
23 cm / 9"  
15 mm



1/2  
**455-06-15**  
24 cm / 9 1/2"  
15 mm



1/2  
Semb  
455-01-12 To 455-06-15



1/4  
**455-07-10**  
18.5 cm / 7 1/4"  
10 mm

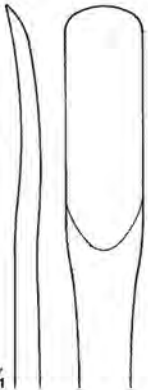

1/4  
**455-08-10**  
19 cm / 7 1/2"  
10 mm

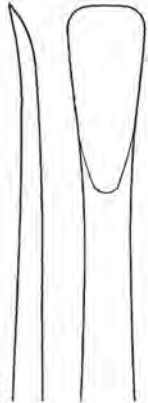

1/4  
9.5 cm

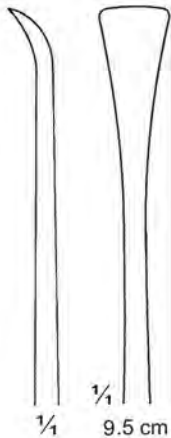

Kramer  
455-07-10 & 455-08-10

Alexander  
455-09-09  
20 cm / 8"



Alexander  
455-10-12  
21 cm / 8 1/4"

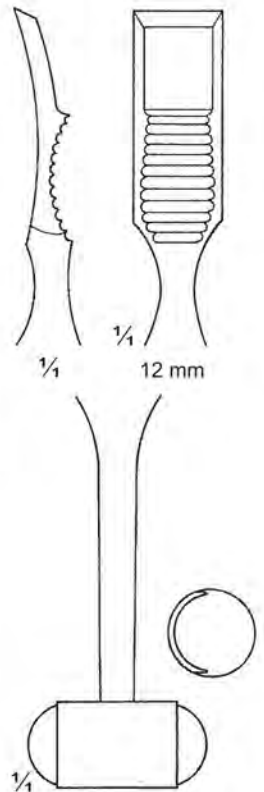



Raspatorien; Legras  
 Raspatories; Raspadori  
 Raspatoires; Raspadores

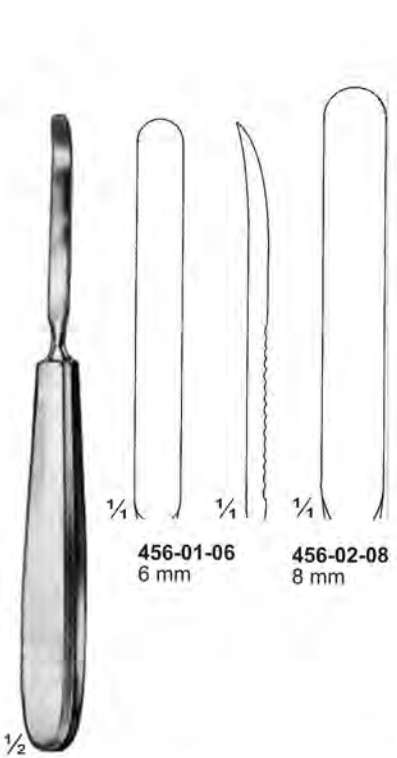

456-01-06  
6 mm

456-02-08  
8 mm

456-01-06 & 456-02-08  
17 cm / 6 3/4"

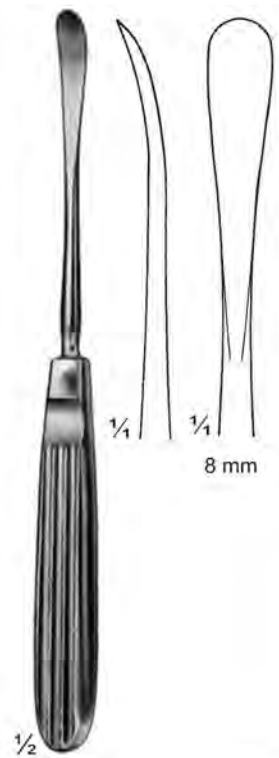

Cottle  
456-03-08  
19.5 cm / 7 3/4"

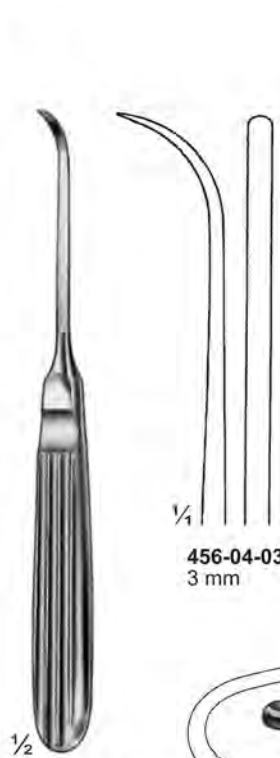

456-04-03  
3 mm

456-05-06  
6 mm

456-04-03 & 456-05-06  
17 cm / 6 3/4"



456-11-24  
24 cm / 9 1/2"

456-12-24  
24 cm / 9 1/2"

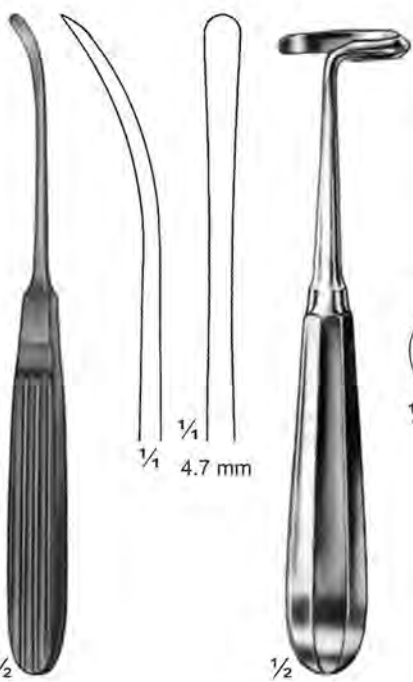

Landolt  
456-06-04  
18 cm / 7"

Doyen  
456-07-17 To 456-10-17  
17 cm / 6 3/4"

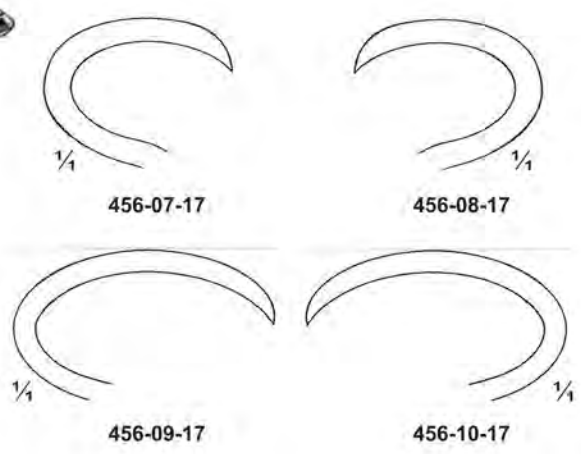

456-07-17

456-08-17

456-09-17

456-10-17

Doyen  
456-11-24  
24 cm / 9 1/2"

Doyen  
456-12-24  
24 cm / 9 1/2"

Raspatorien; Legras  
Raspatories; Raspadori  
Raspatoires; Raspadores

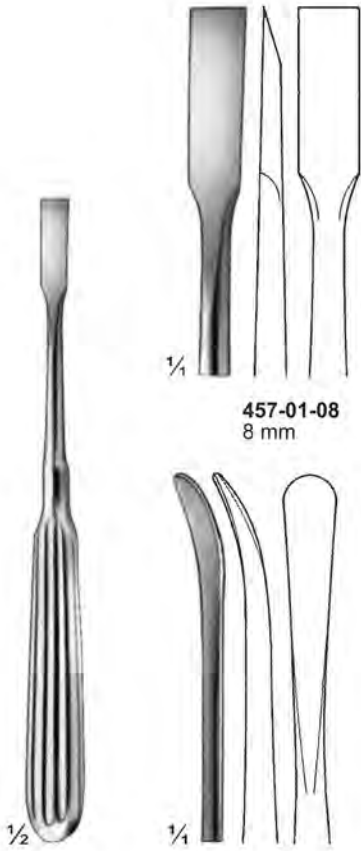

457-01-08  
8 mm

457-03-07  
7 mm

Adson  
457-01-08 To 457-04-07  
17 cm / 6 3/4"



457-02-07  
7 mm

457-04-07  
7 mm

Mathieu  
457-05-06 & 457-06-09  
14 cm / 5 1/2"

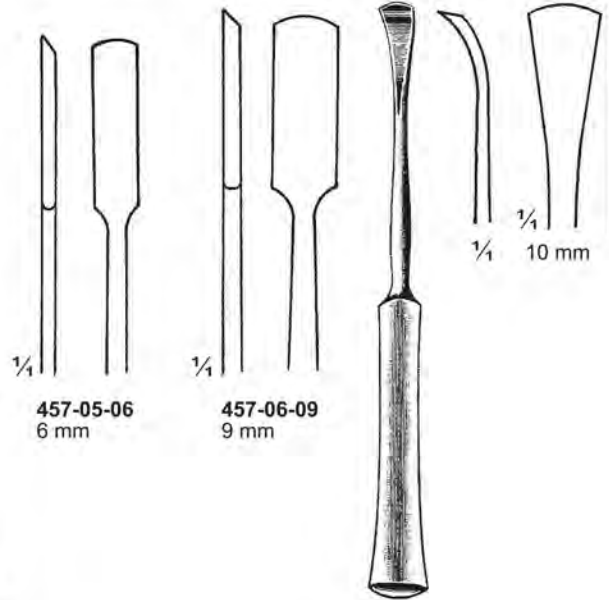

457-05-06  
6 mm

457-06-09  
9 mm

Hylin  
457-07-10  
14.5 cm / 5 3/4"

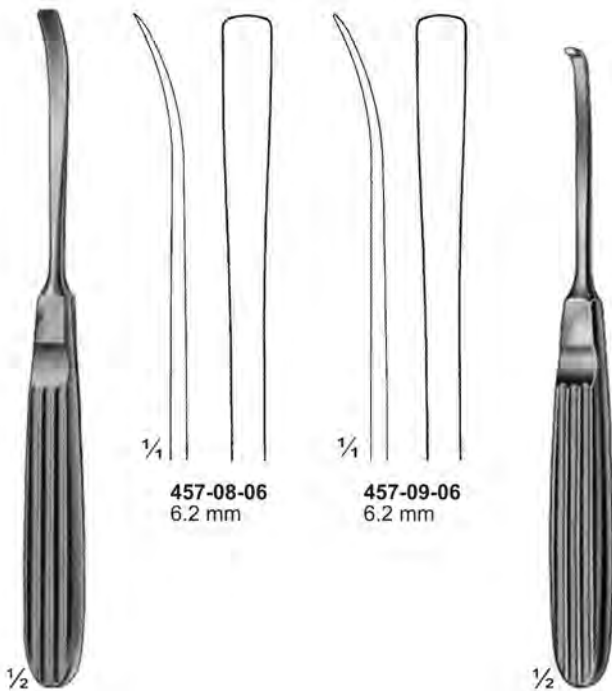

457-08-06  
6.2 mm

457-09-06  
6.2 mm

Caspar  
457-08-06 & 457-09-06  
18 cm / 7"

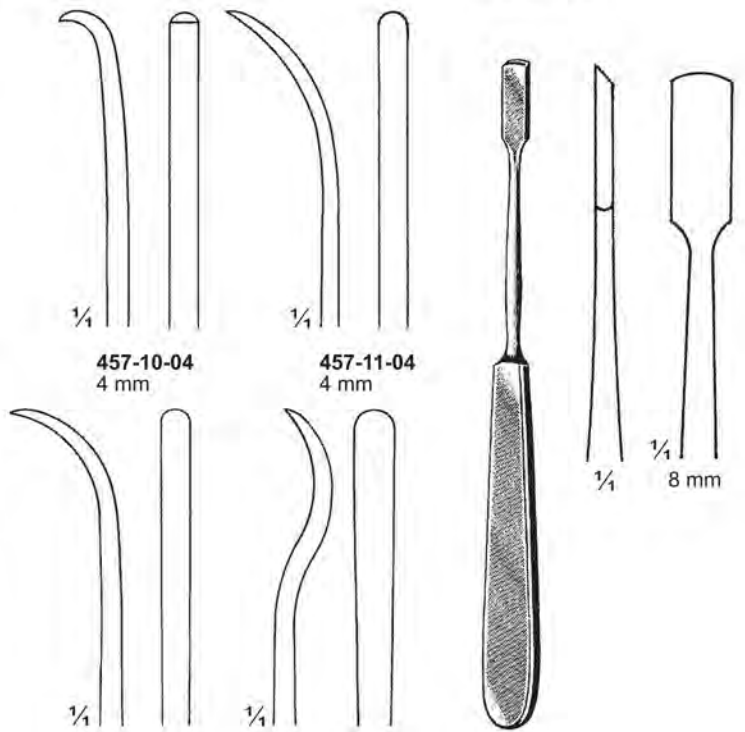

457-10-04  
4 mm

457-11-04  
4 mm

457-12-04  
4 mm

457-13-06  
6 mm

Muhling  
457-10-04 To 457-13-06  
17 cm / 6 3/4"

Olivecrona  
457-14-08  
18 cm / 7"

**Raspatorien; Legras  
Raspatories; Raspadori  
Raspatoires; Raspadores**

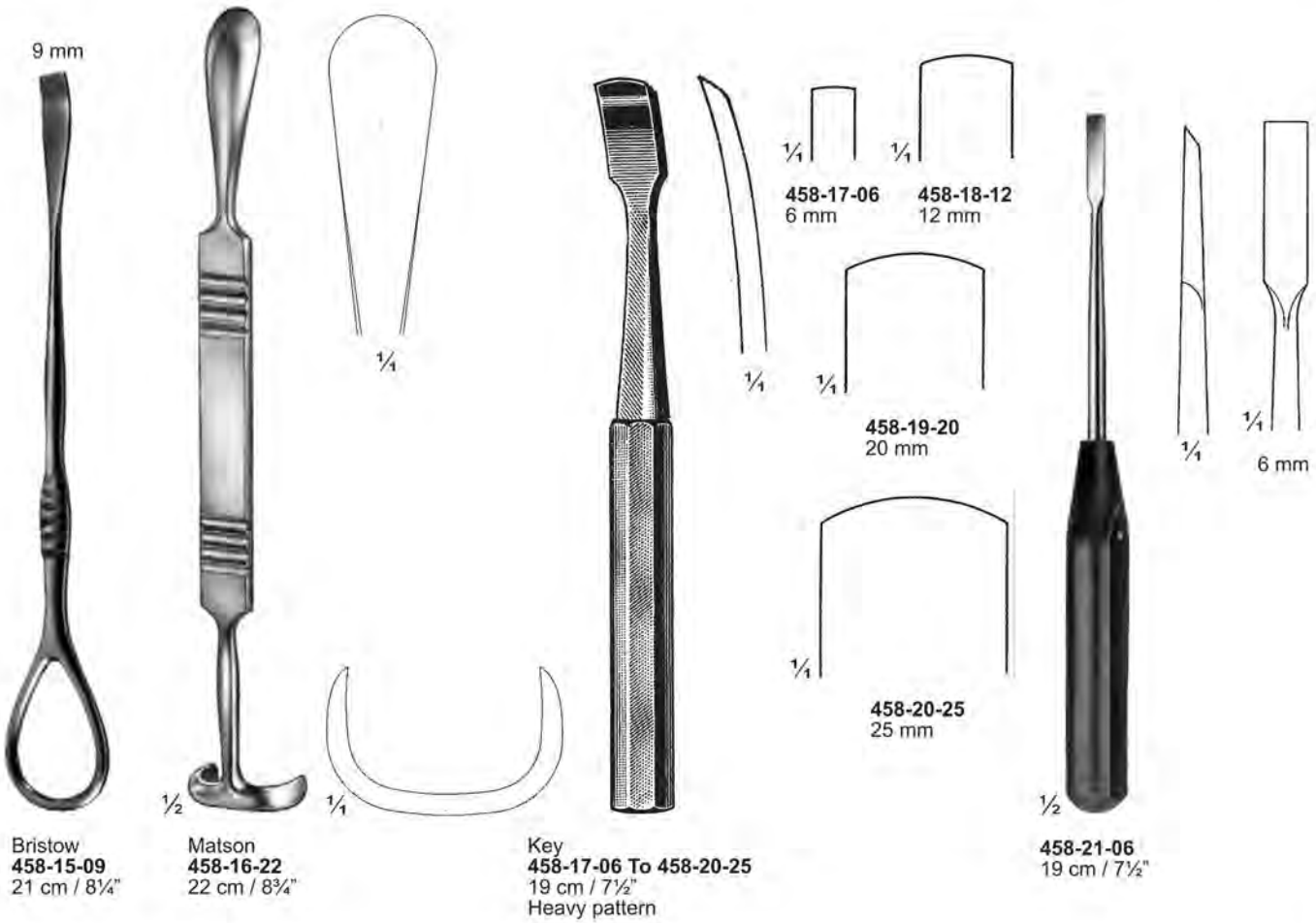
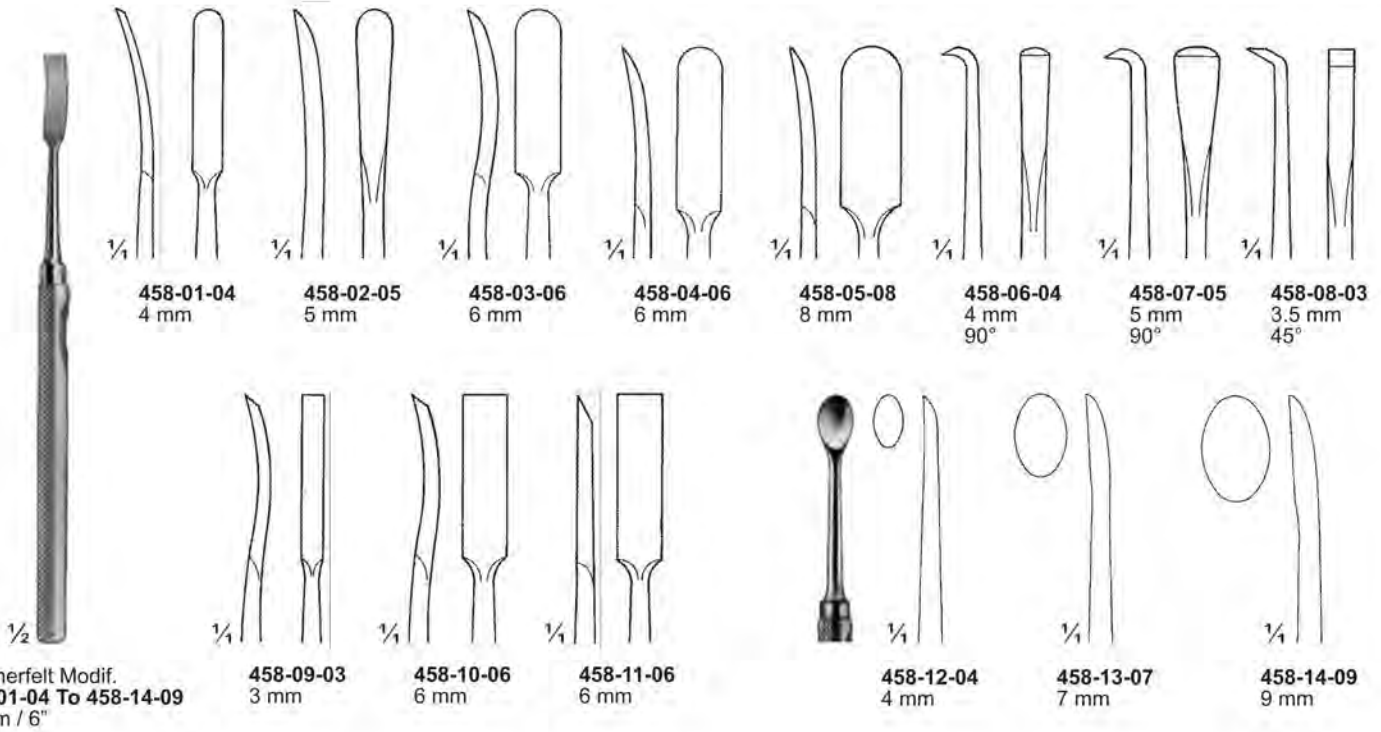

Raspatorien; Legras  
 Raspatories; Raspadori  
 Raspatoires; Raspadores

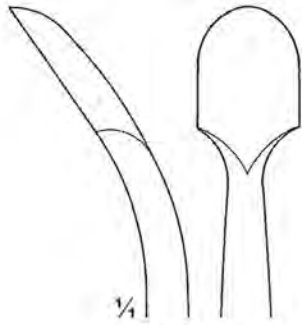

459-01-14  
14 mm

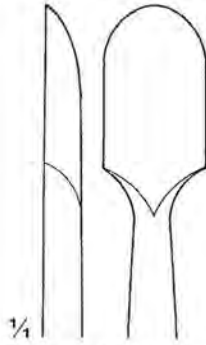

459-02-14  
14 mm

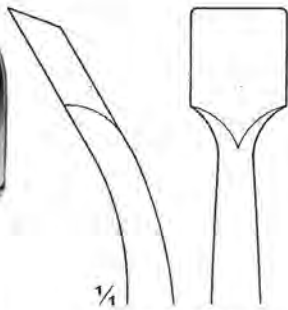

459-03-13  
13 mm

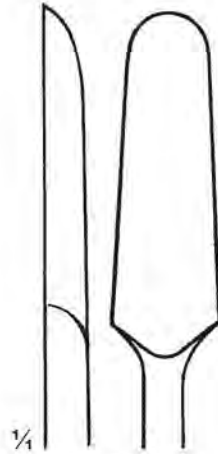

459-04-13  
13 mm

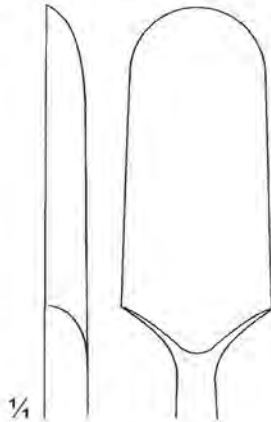

459-05-20  
20 mm



459-01-14 To 459-05-20  
20 cm / 8"



Wagner  
 459-06-08 & 459-07-17  
 33 cm / 13"

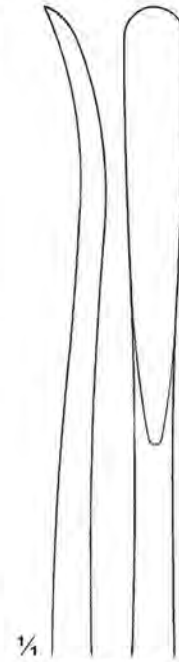

459-06-08  
8 mm

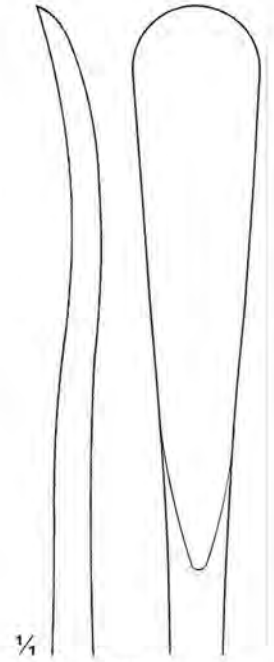

459-07-17  
17 mm

Raspatorien; Legras  
 Raspatories; Raspadori  
 Raspatoires; Raspadores





**Elevatorien; Elevadores parahuesos  
Bone Elevators ; Elevatori per ossa  
Elévateurs; Elevadores para ossos**

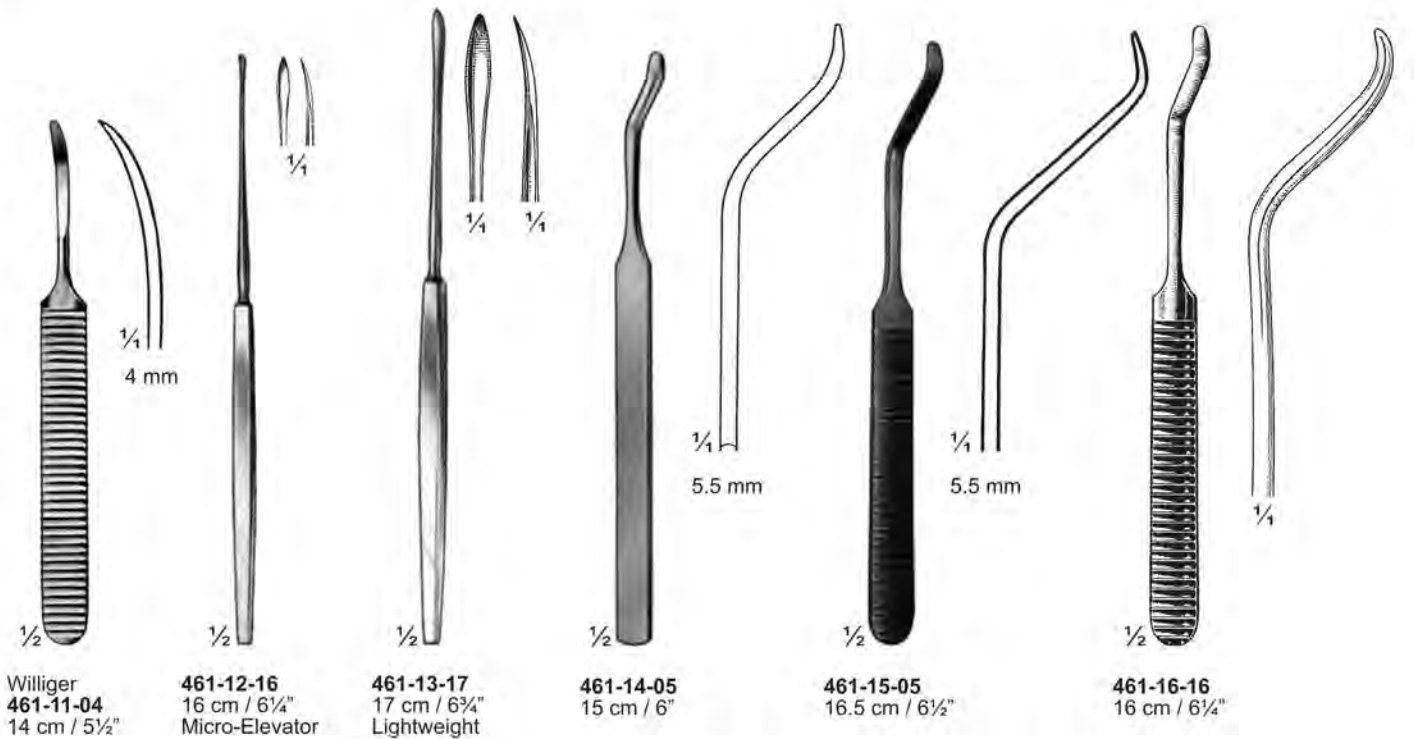
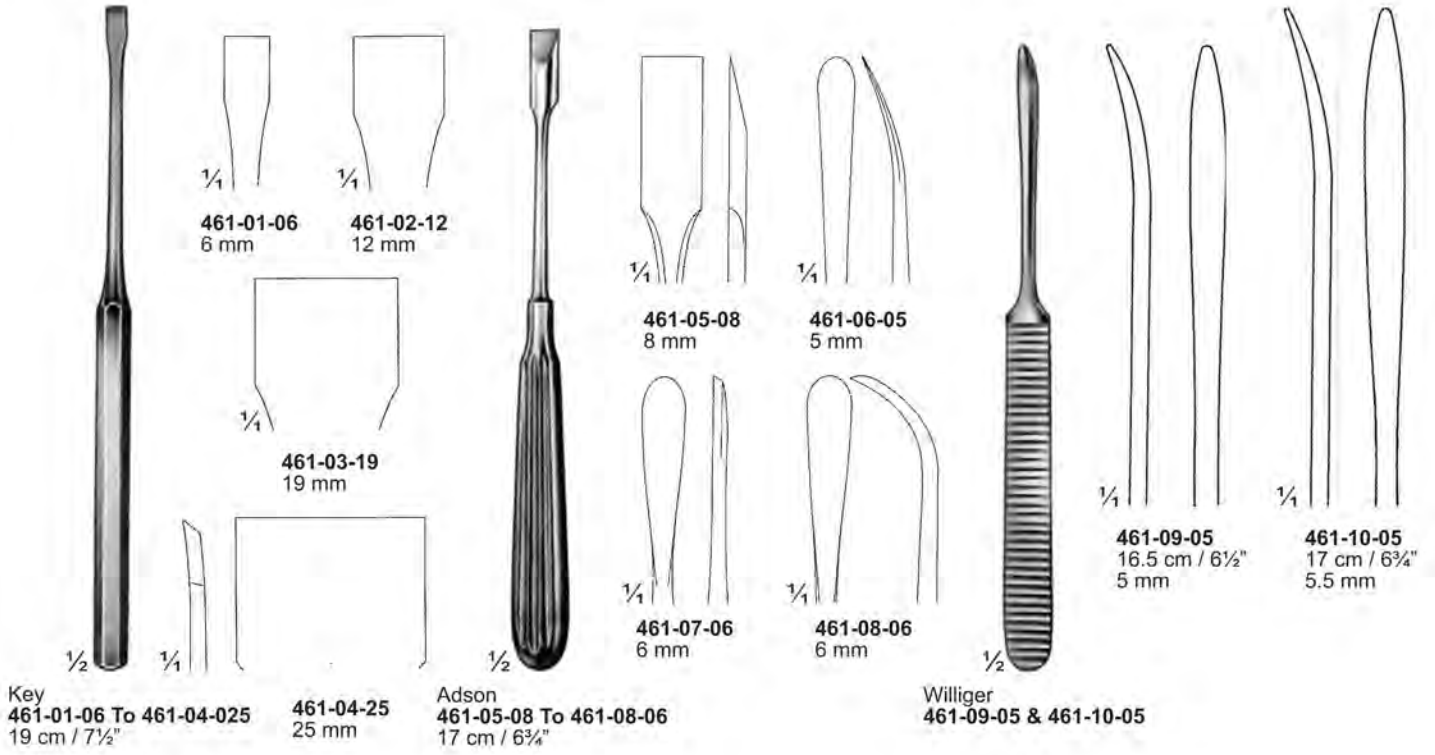

**Elevatorien; Elevadores parahuesos  
Bone Elevators ; Elevatori per ossa  
Elévateurs; Elevadores para ossos**

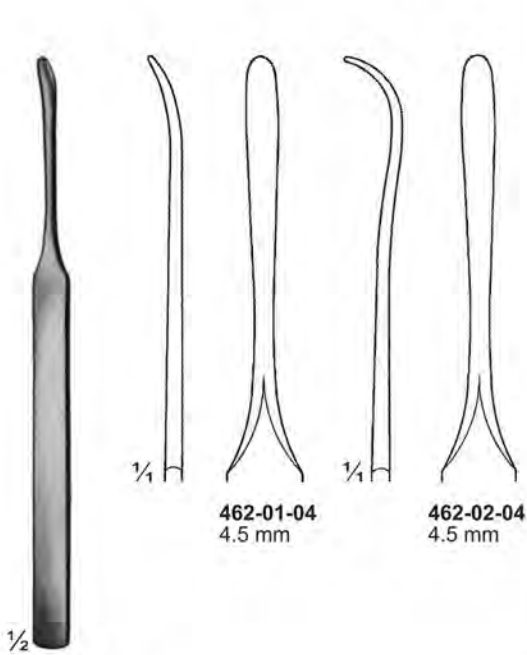

Koenig  
462-01-04 & 462-02-04  
15 cm / 6"

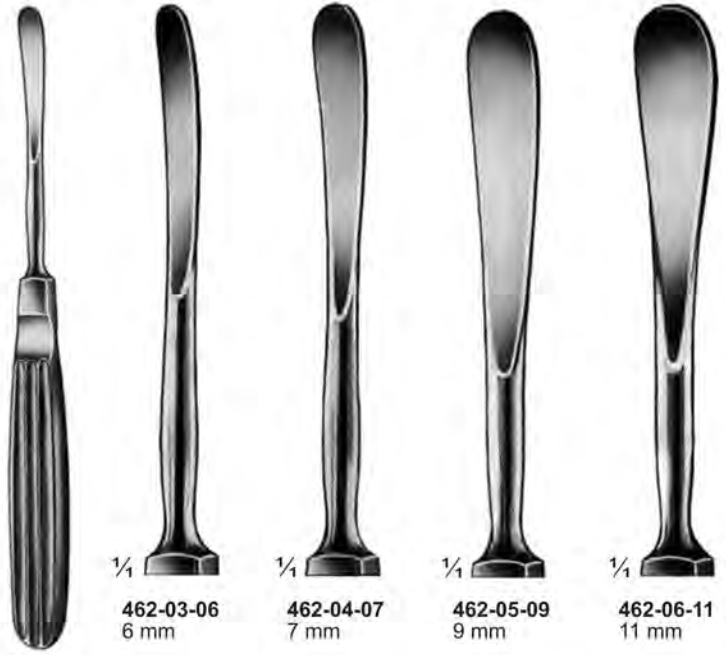

Obwegesser  
462-03-06 To 462-06-11  
18 cm / 7"

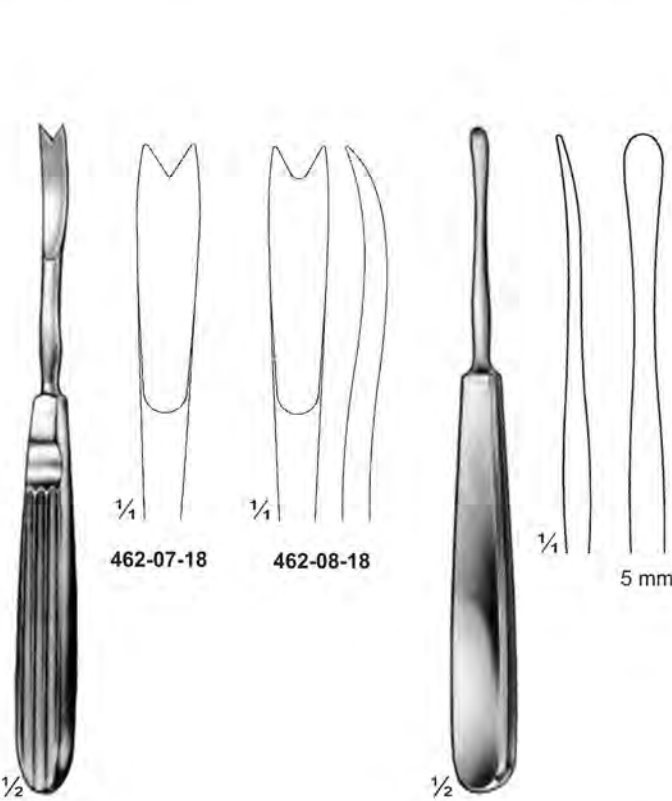

Obwegesser  
462-07-18 & 462-08-18  
18 cm / 7"

Sebileau  
462-09-05  
18 cm / 7"

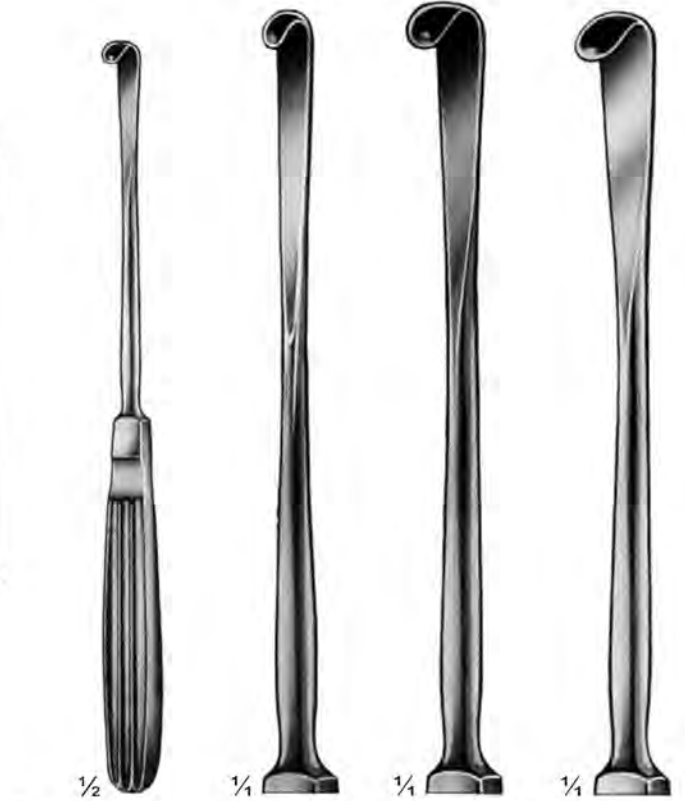

Obwegesser  
462-10-05 To 462-12-09  
20 cm / 8"

462-10-05  
5 mm

462-11-07  
7 mm

462-12-09  
9 mm

**Elevatorien; Elevadores para huesos  
Bone Elevators ; Elevatori per ossa  
Elévateurs; Elevadores para ossos**



Obwegesser  
463-01-21  
21 cm / 8 1/4"



Obwegesser  
463-02-21  
21 cm / 8 1/4"



Alderdyce  
463-03-21  
21 cm / 8 1/4"



McDonald  
463-04-19  
19 cm / 7 1/2"

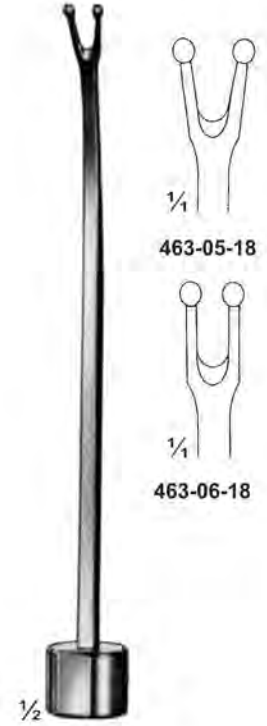

463-05-18  
463-06-18

Obwegesser  
463-05-18 & 463-06-18  
18.5 cm / 7 1/4"

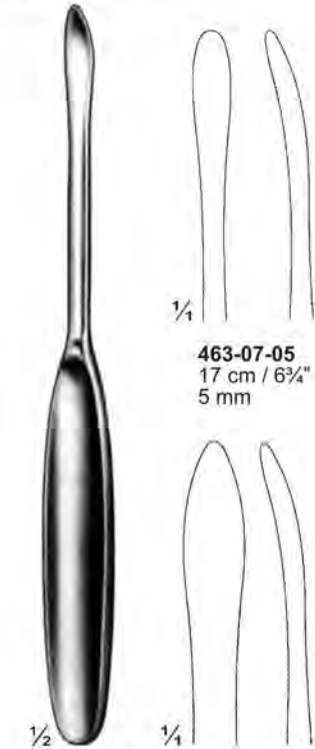

Langenbeck  
463-07-05 To 463-10-10  
20 cm / 8"  
8 mm

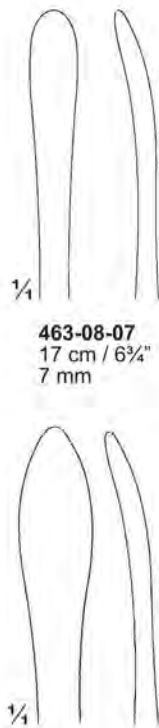

463-08-07  
17 cm / 6 3/4"  
7 mm



Obwegesser  
463-11-02 To 463-13-06  
15 cm / 6"

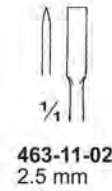

463-11-02  
2.5 mm

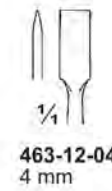

463-12-04  
4 mm

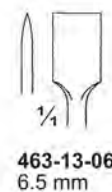

463-13-06  
6.5 mm



Langenbeck  
463-14-11  
23 cm / 9"

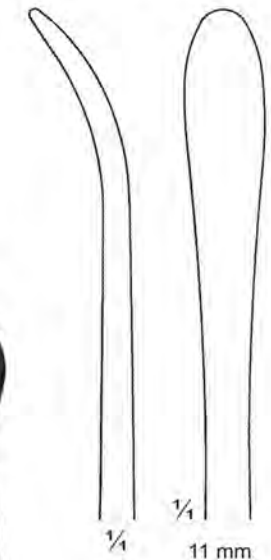

11 mm



**Knochenheber; Elevadores para huesos  
Bone Lever ; Elevatori per ossa  
Leviers à os; Elevadores para ossos**

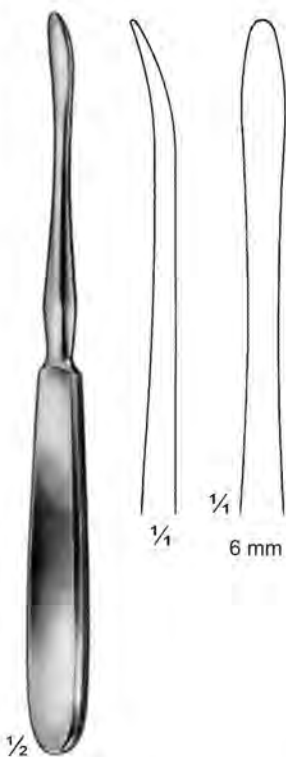

**Quervain**  
464-01-06  
19.5 cm / 7 3/4"

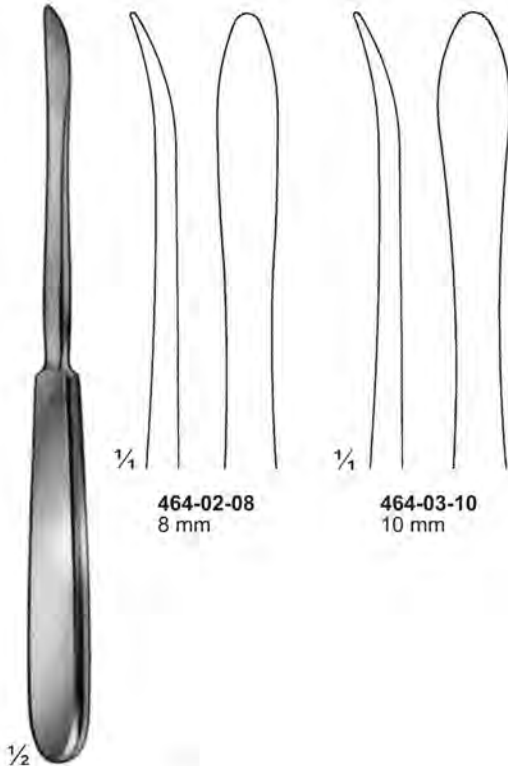

**Langenbeck**  
464-02-08 & 464-03-10  
19.5 cm / 7 3/4"

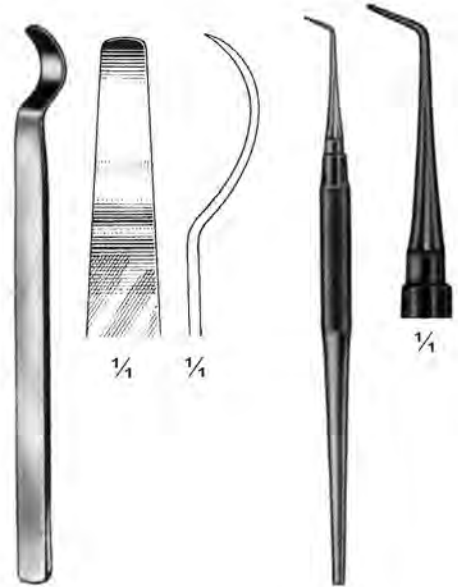

**Bunnell**  
464-05-14  
14 cm / 5 1/2"

**464-04-14**  
14 cm / 5 1/2"

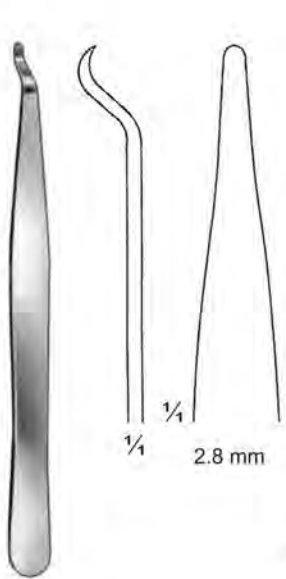

**464-06-02**  
15 cm / 6"

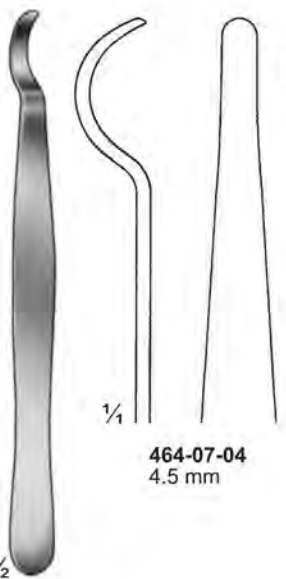

**464-07-04 & 464-08-06**  
15 cm / 6"

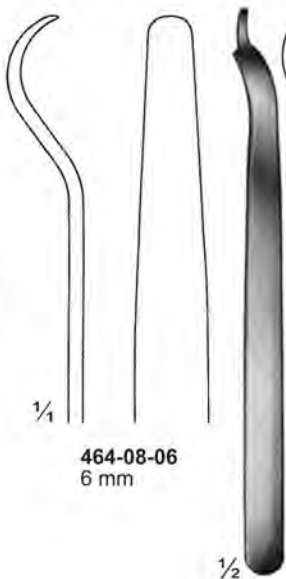

**Buck-Gramcko**  
464-09-07  
15 cm / 6"

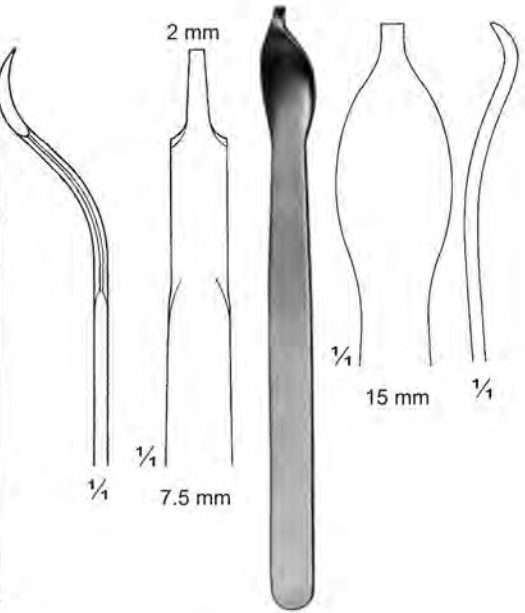

**464-10-15**  
15 cm / 6"

**Knochenheber; Elevadores parahuesos  
Bone Lever; Elevatori per ossa  
Leviers à os; Elevadores para ossos**

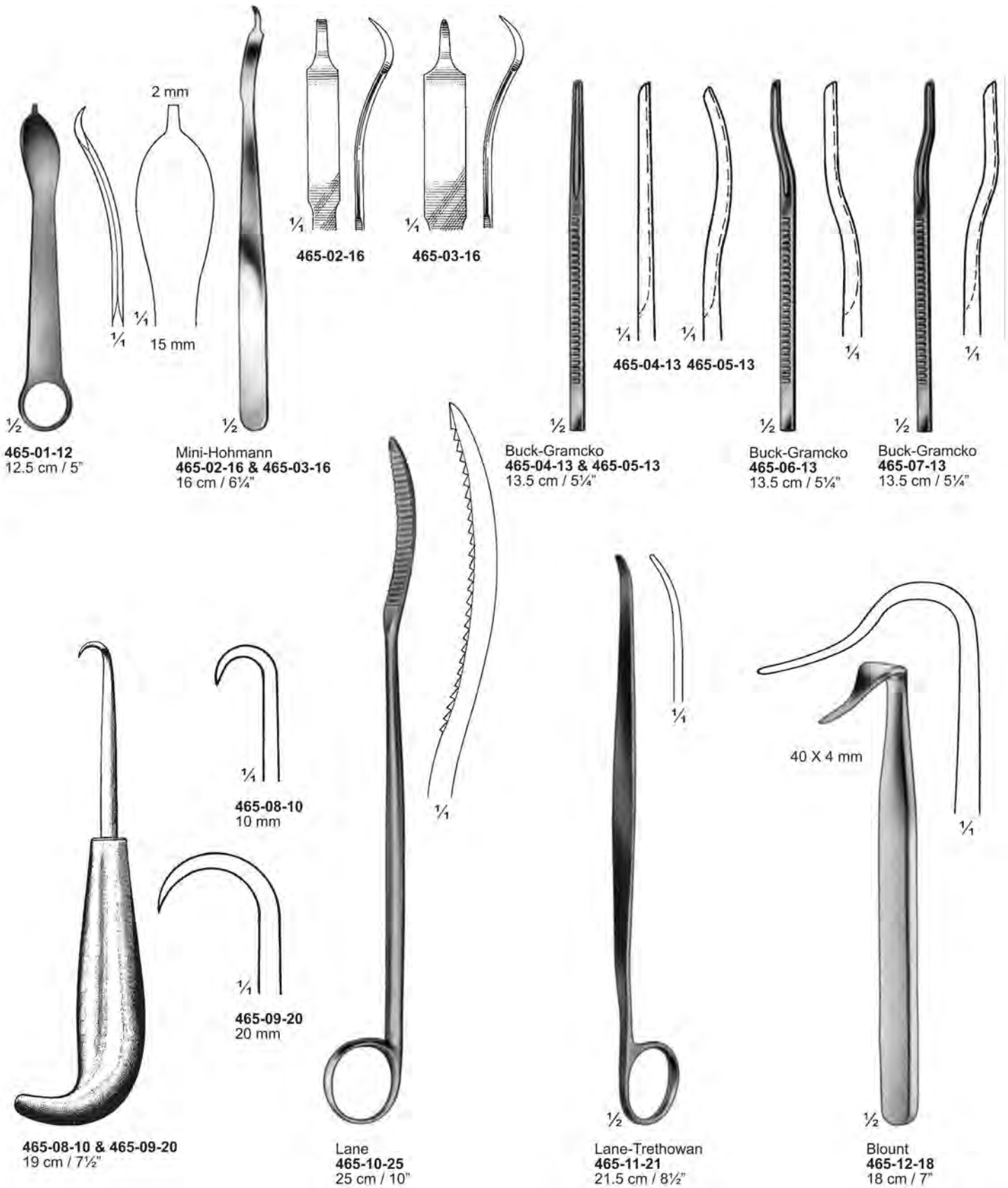



**Knochenheber; Elevadores para huesos  
Bone Lever; Elevatori per ossa  
Leviers à os; Elevadores para ossos**



1/3  
Blount  
466-01-26  
26 cm / 10 1/4"



1/3  
Blount  
466-02-26  
26 cm / 10 1/4"



1/2  
Lange-Baby  
466-03-17  
17 cm / 6 3/4"



Taylor  
466-04-100 & 466-05-75  
16.5 cm / 6 1/2"

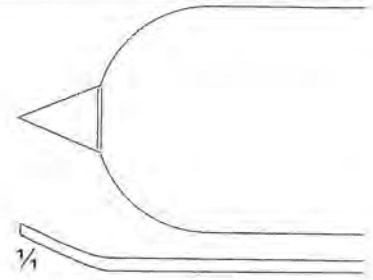

466-04-100  
100 X 30 mm

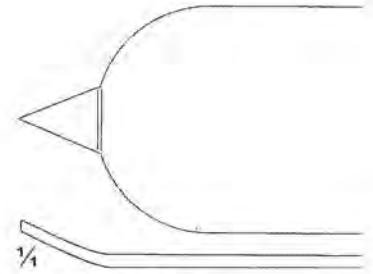

466-05-75  
75 X 30 mm



30 mm

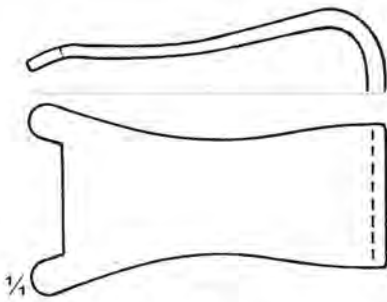

466-06  
26 X 43 mm

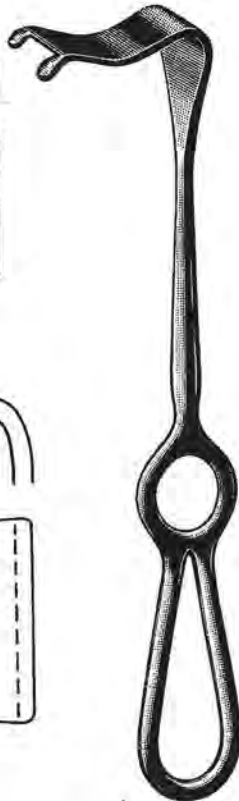

Blount  
466-06-26 & 466-07-33  
24 cm / 9 1/2"



1/2  
Lange  
466-08-22  
22 cm / 8 3/4"

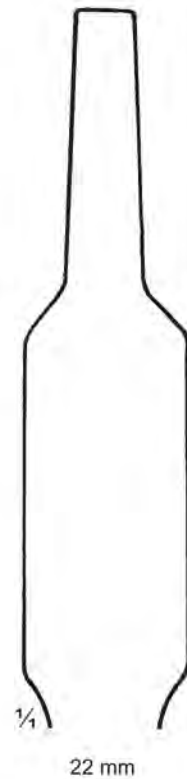

22 mm

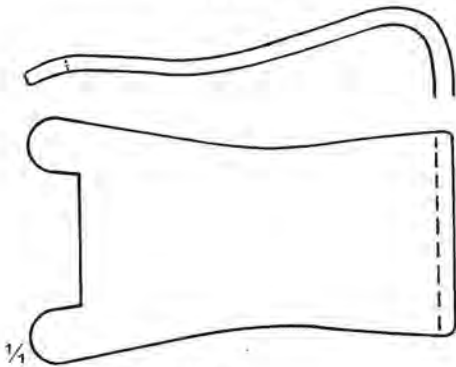

466-07  
33 X 54 mm

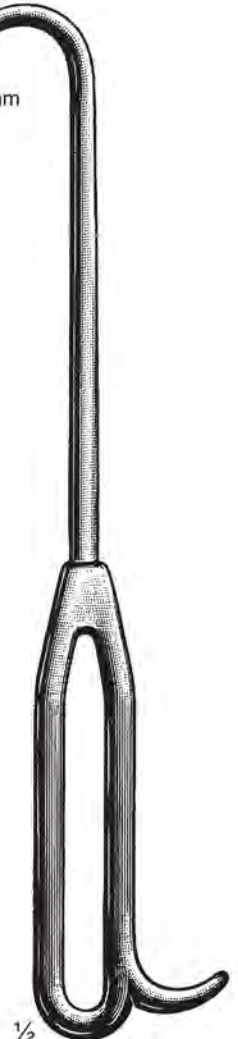

1/2  
Lambotte  
466-09-30  
27 cm / 10 1/2"



**Knochenhebel; Elevadores para huesos  
Bone Lever ; Elevatori per ossa  
Leviers à os; Elevadores para ossos**

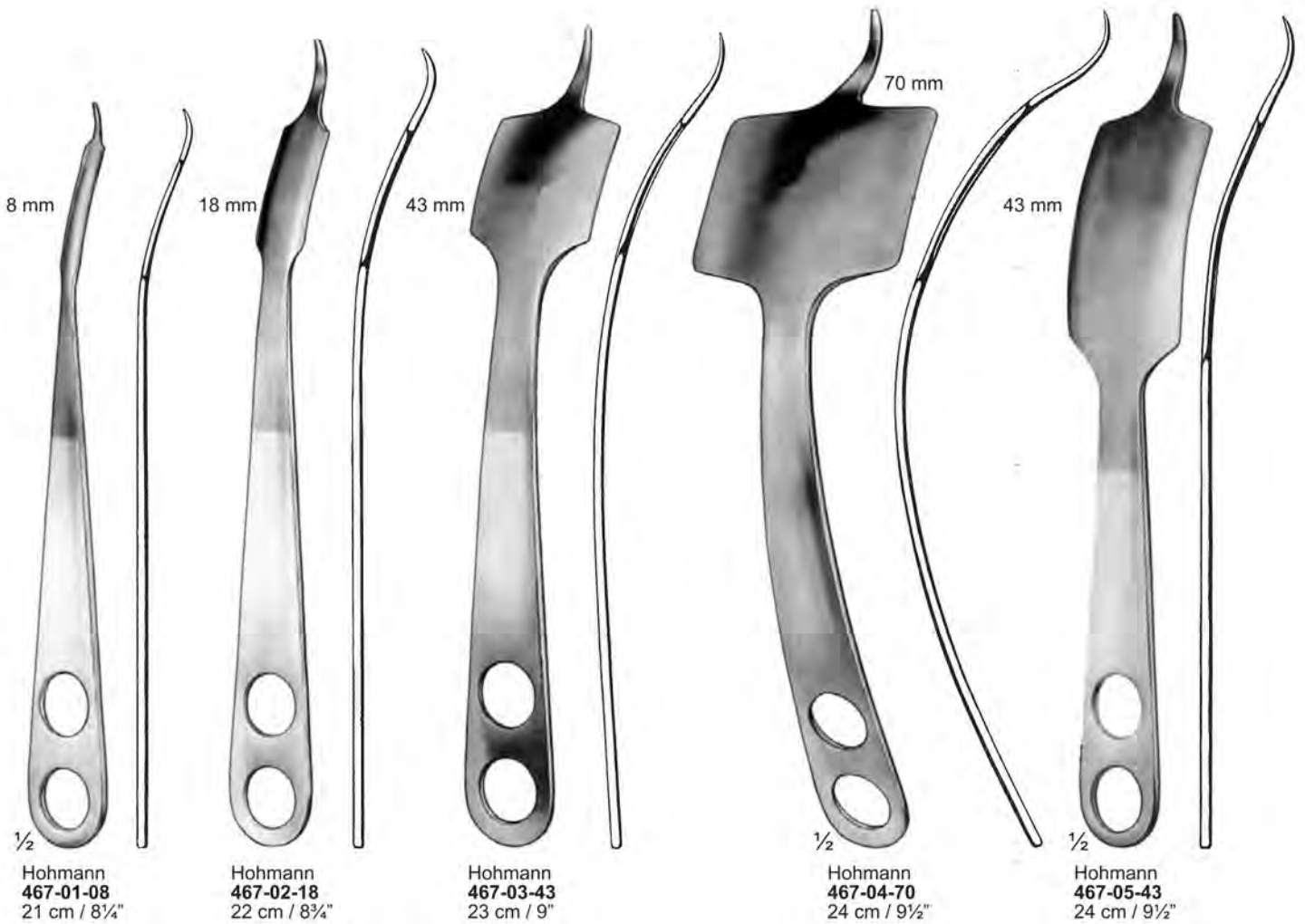

Hohmann  
467-01-08  
21 cm / 8 1/4"

Hohmann  
467-02-18  
22 cm / 8 3/4"

Hohmann  
467-03-43  
23 cm / 9"

Hohmann  
467-04-70  
24 cm / 9 1/2"

Hohmann  
467-05-43  
24 cm / 9 1/2"

**Knochenheber; Elevadores para huesos  
Bone Lever ; Elevatori per ossa  
Leviers à os; Elevadores para ossos**

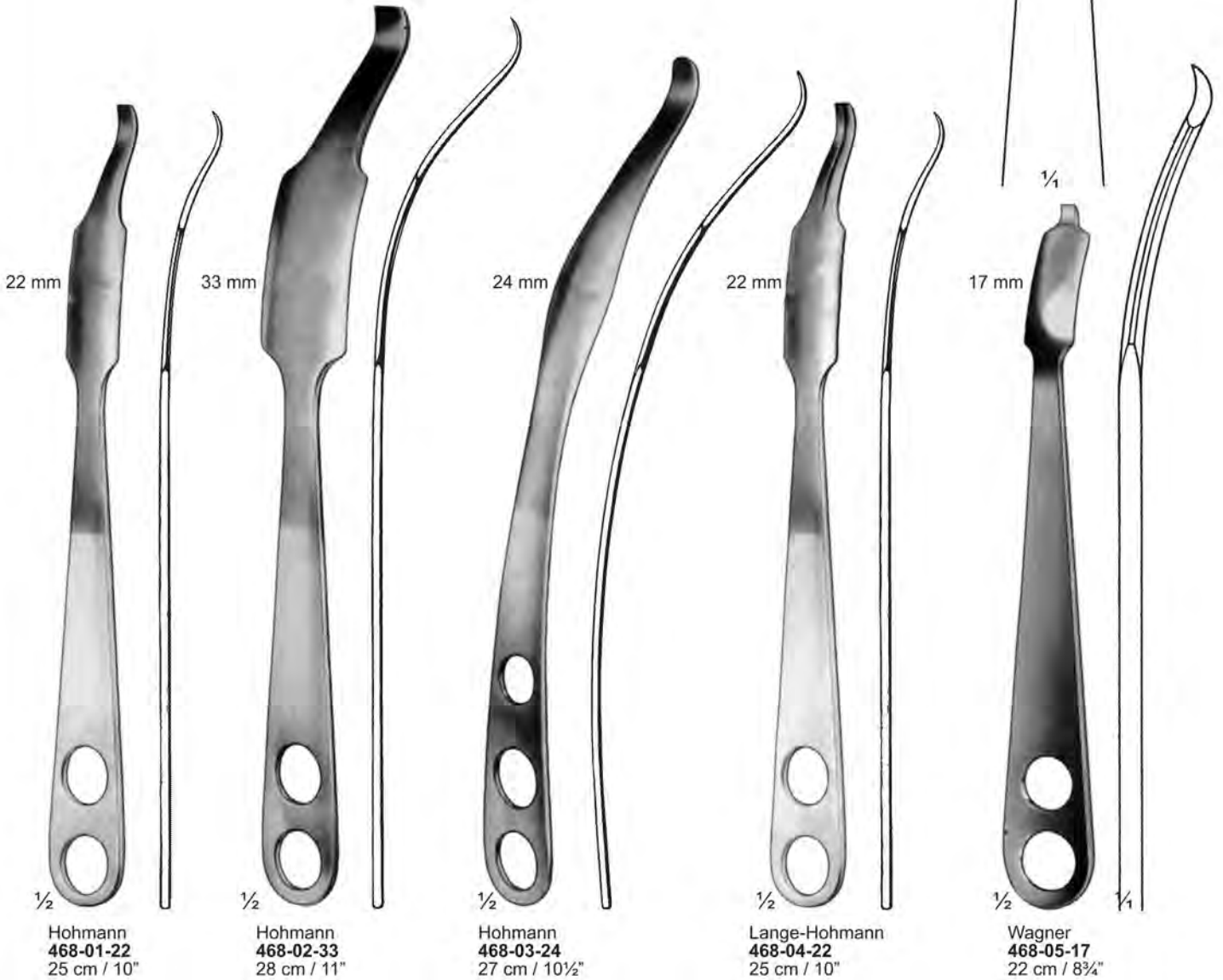

**Knochenhebel; Elevadores parahuesos  
Bone Lever ; Elevatori per ossa  
Leviers à os; Elevadores para ossos**

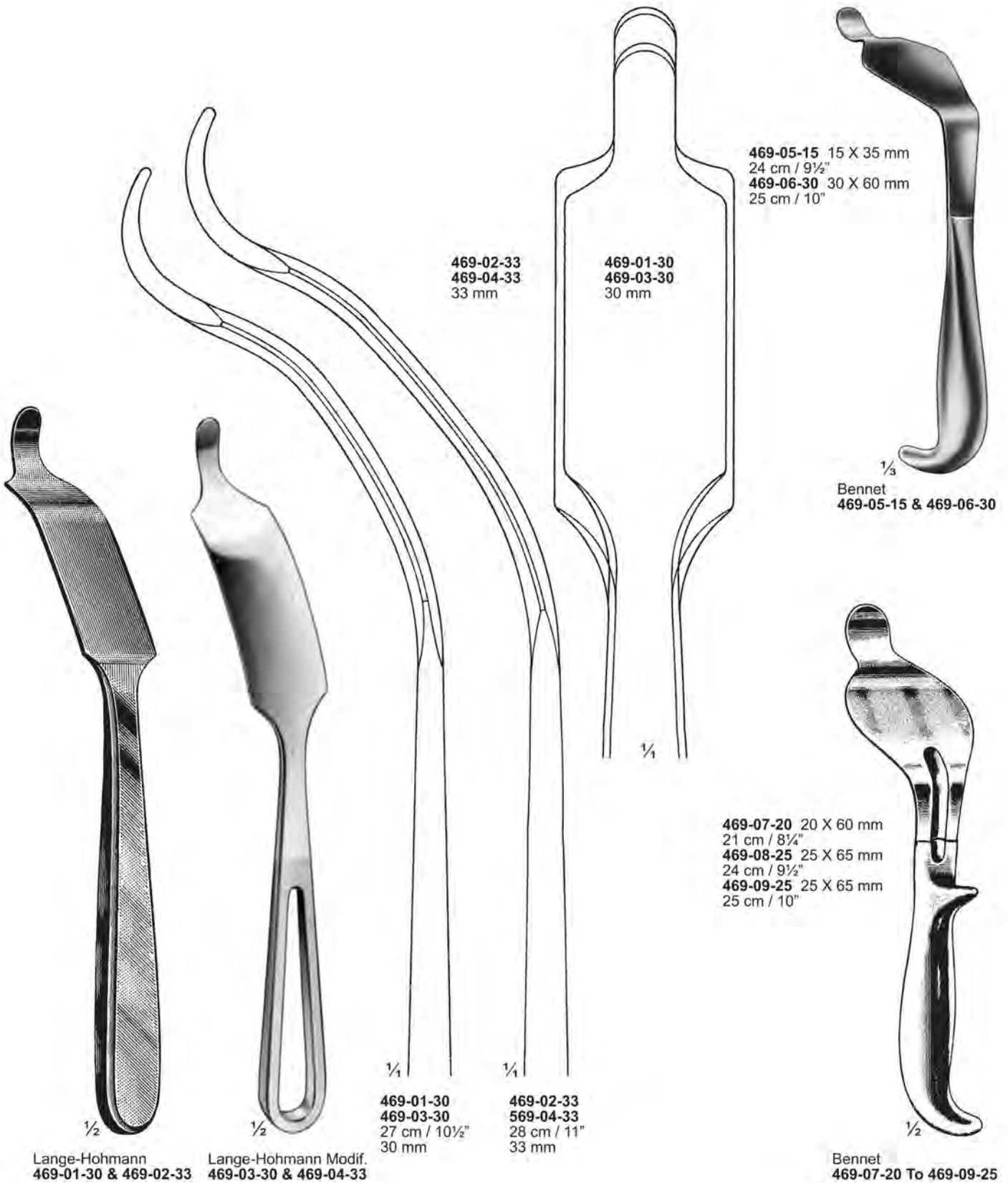



**Knochenhebel; Elevadores para huesos  
Bone Lever ; Elevatori per ossa  
Leviers à os; Elevadores para ossos**

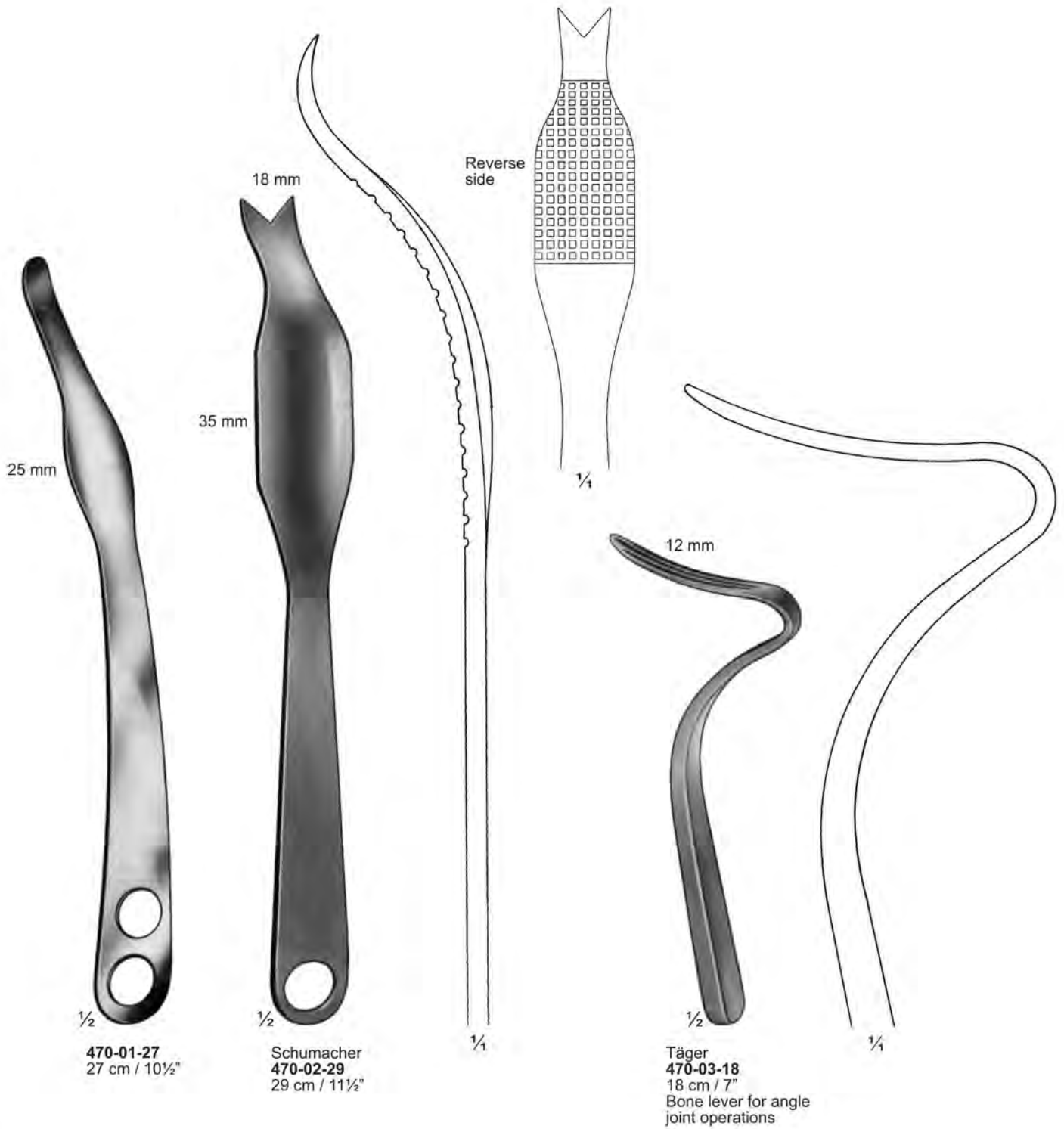



**Knochenheber; Elevadores para huesos  
Bone Lever ; Elevatori per ossa  
Leviers à os; Elevadores para ossos**

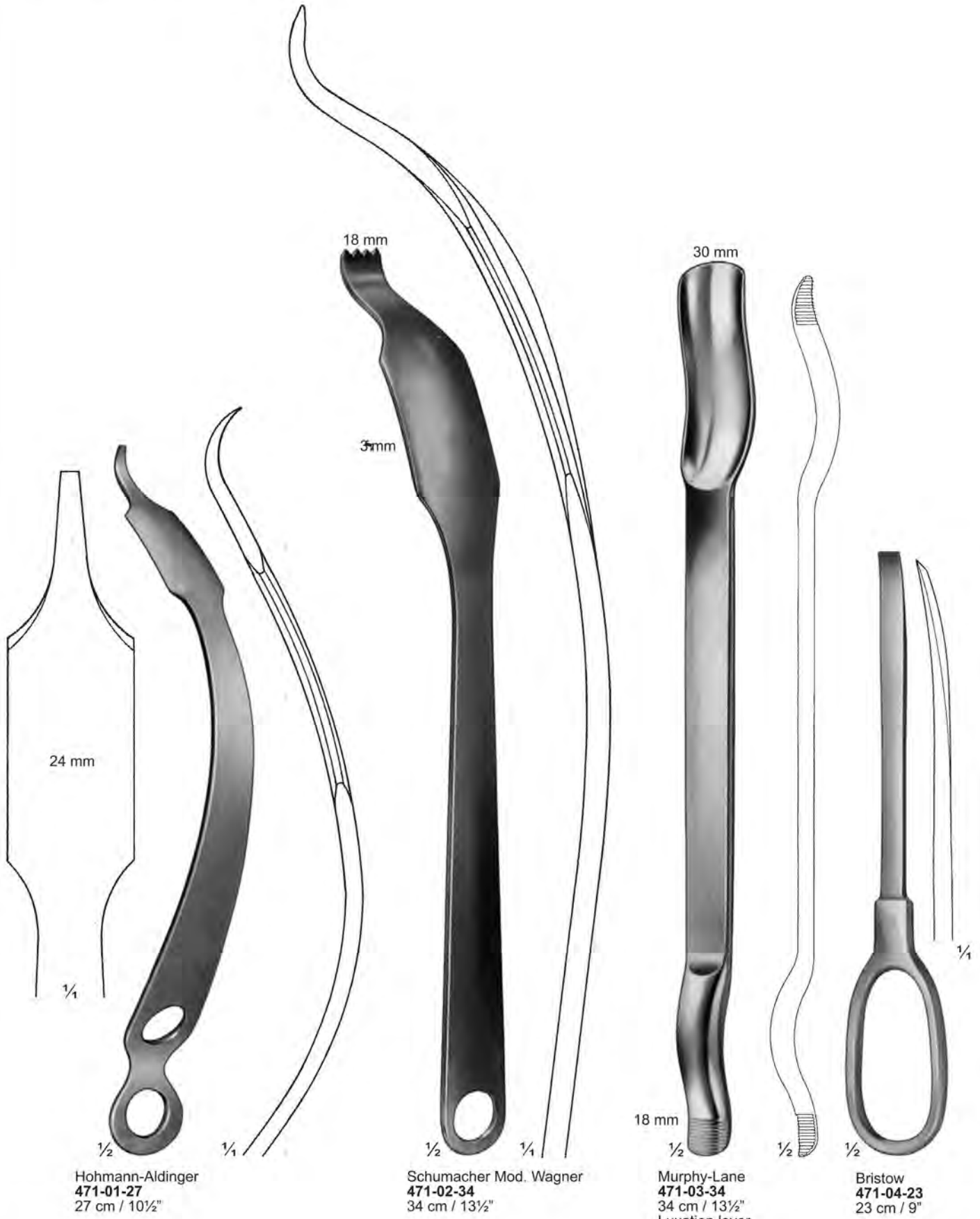

Hohmann-Aldinger  
471-01-27  
27 cm / 10 1/2"

Schumacher Mod. Wagner  
471-02-34  
34 cm / 13 1/2"

Murphy-Lane  
471-03-34  
34 cm / 13 1/2"  
Luxation lever

Bristow  
471-04-23  
23 cm / 9"



**Knochenheber; Elevadores para huesos  
 Bone Lever ; Elevatori per ossa  
 Leviers à os; Elevadores para ossos**





**Knochenfeilen, Knochenraspeln; Limas y raspas para huesos  
Bone Files and Bone Rasps; Lime e raspe per ossa  
Râpes à os et limes à os; Laminas e raspadores para ossos**



**Knochenfeilen, Knochenraspeln; Limas y raspasparahuesos  
Bone Files and Bone Rasps; Lime e raspe per ossa  
Râpes à os et limes à os; Laminas e raspadoresparaossos**

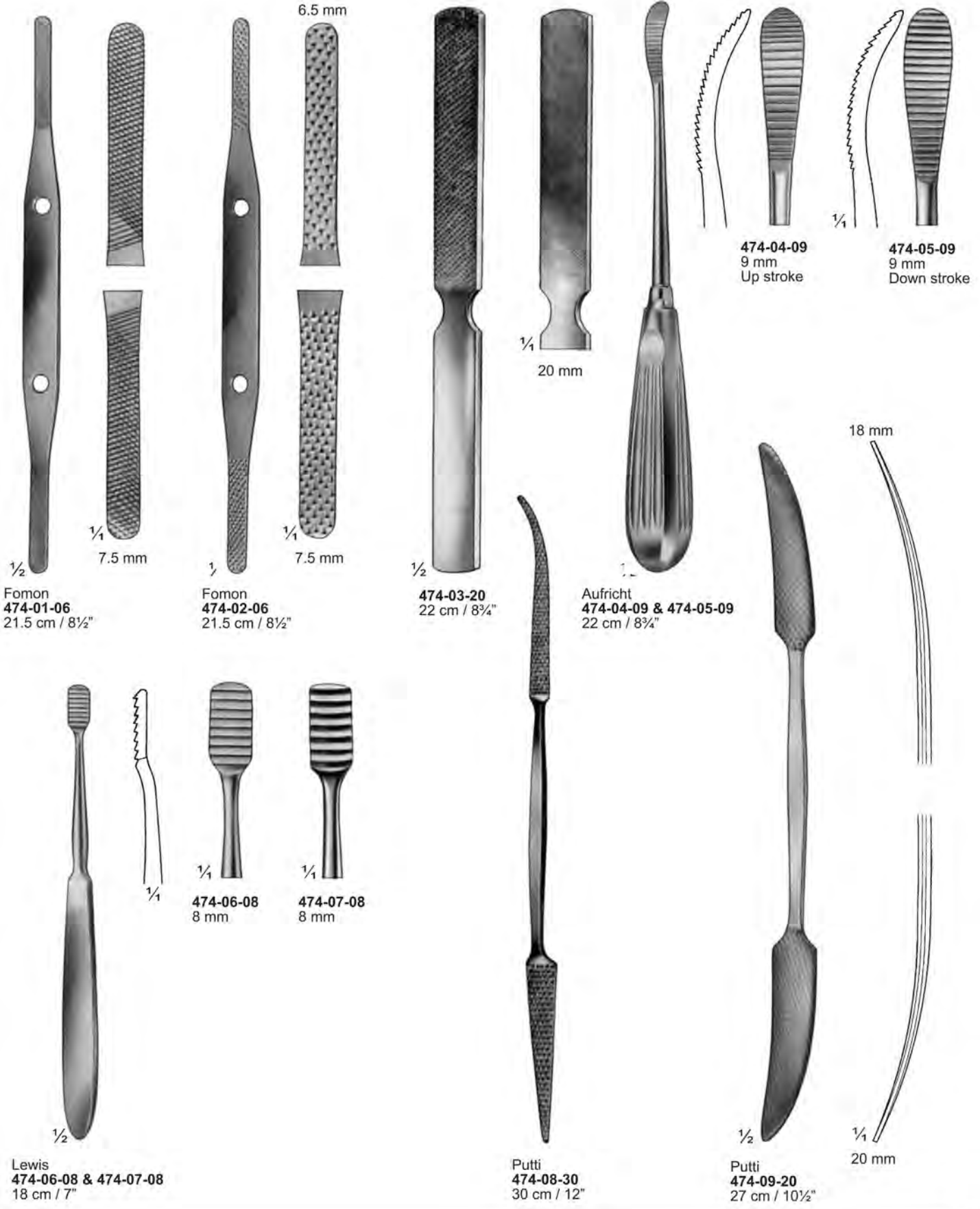

Fomon  
474-01-06  
21.5 cm / 8½"

Fomon  
474-02-06  
21.5 cm / 8½"

474-03-20  
22 cm / 8¾"

Aufricht  
474-04-09 & 474-05-09  
22 cm / 8¾"

Lewis  
474-06-08 & 474-07-08  
18 cm / 7"

Putti  
474-08-30  
30 cm / 12"

Putti  
474-09-20  
27 cm / 10½"



**Knochenfeilen, Knochenraspeln; Limas y raspasparahuesos  
Bone Files and Bone Rasps; Lime e raspe per ossa  
Râpes à os et limes à os; Laminas e raspadoresparaossos**

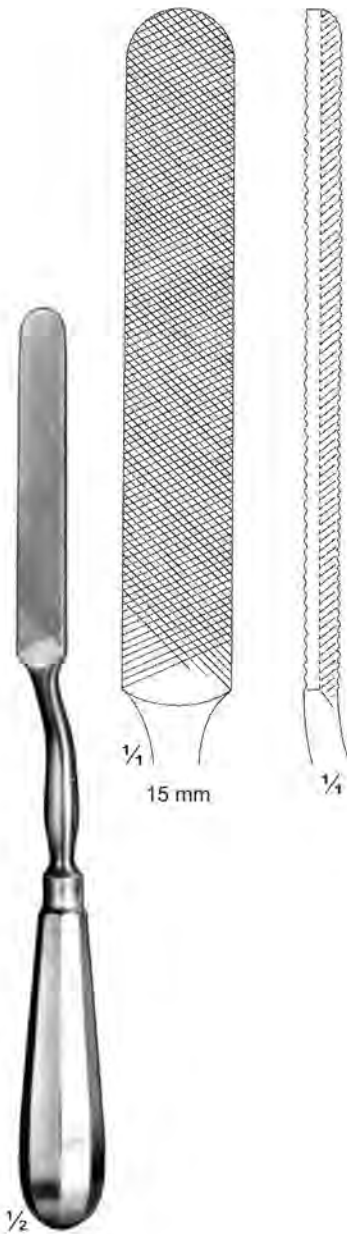

**475-01-15**  
24.5 cm / 9 3/4"

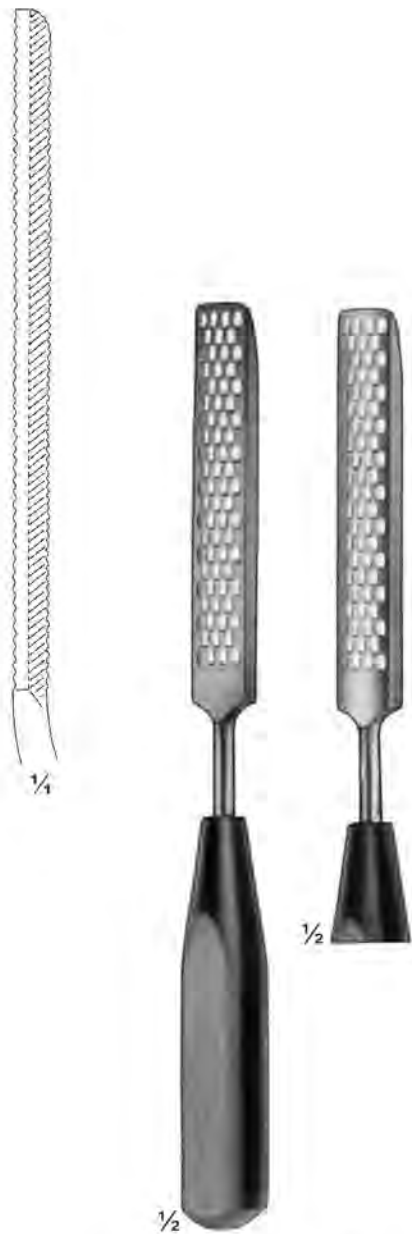

**Eichler**  
**475-02-16 & 475-03-16**  
24.5 cm / 9 3/4"

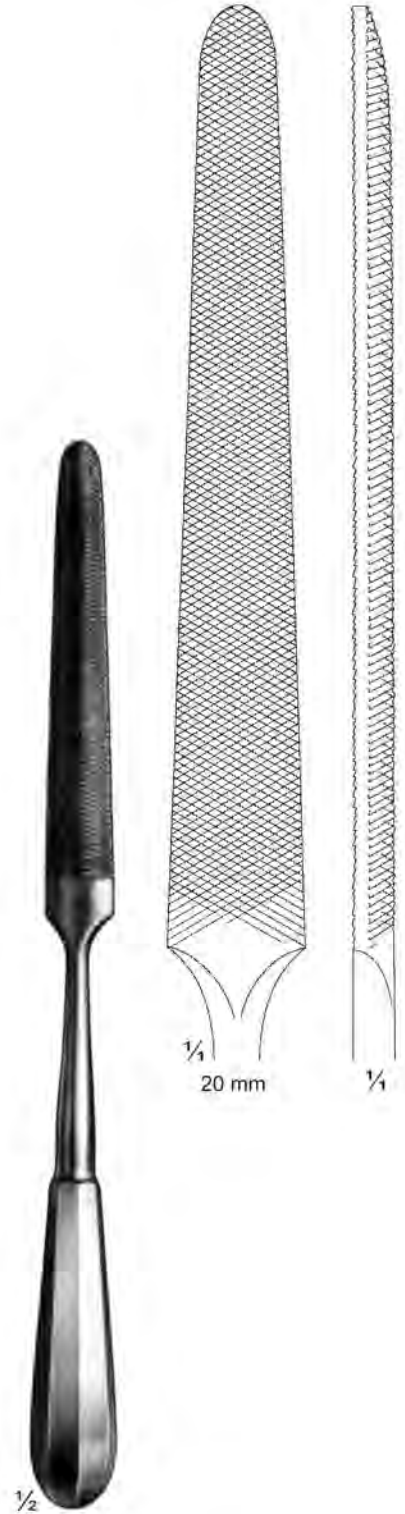
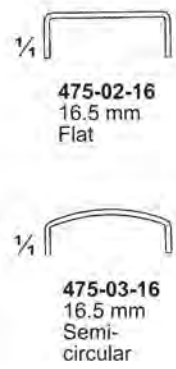

**475-04-20**  
28 cm / 11"



**ScharfeLöffel, Küretten;Cucharillas cortantes  
Bone Curettes ;Curette taglienti  
Curettes tranchantes;Colheres amoladas**

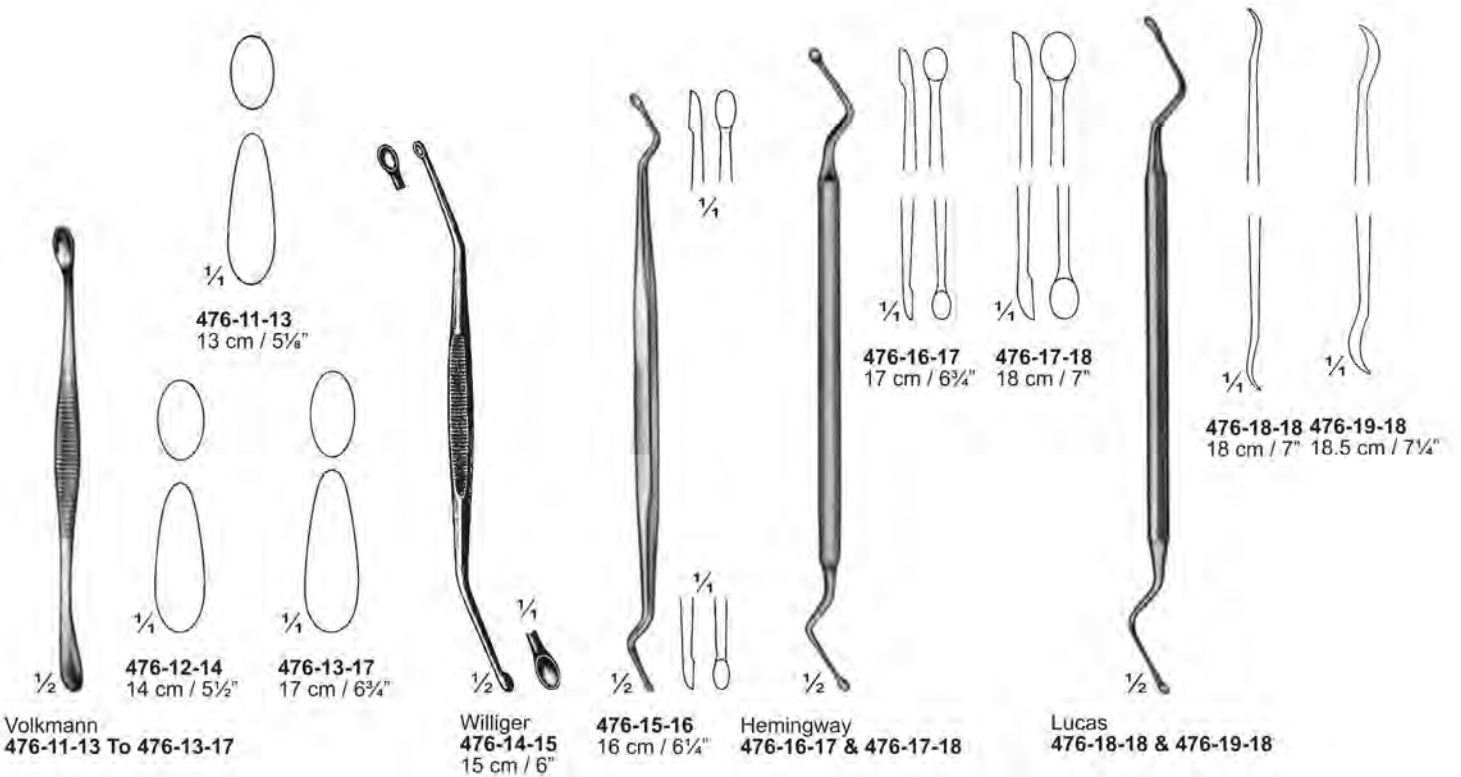
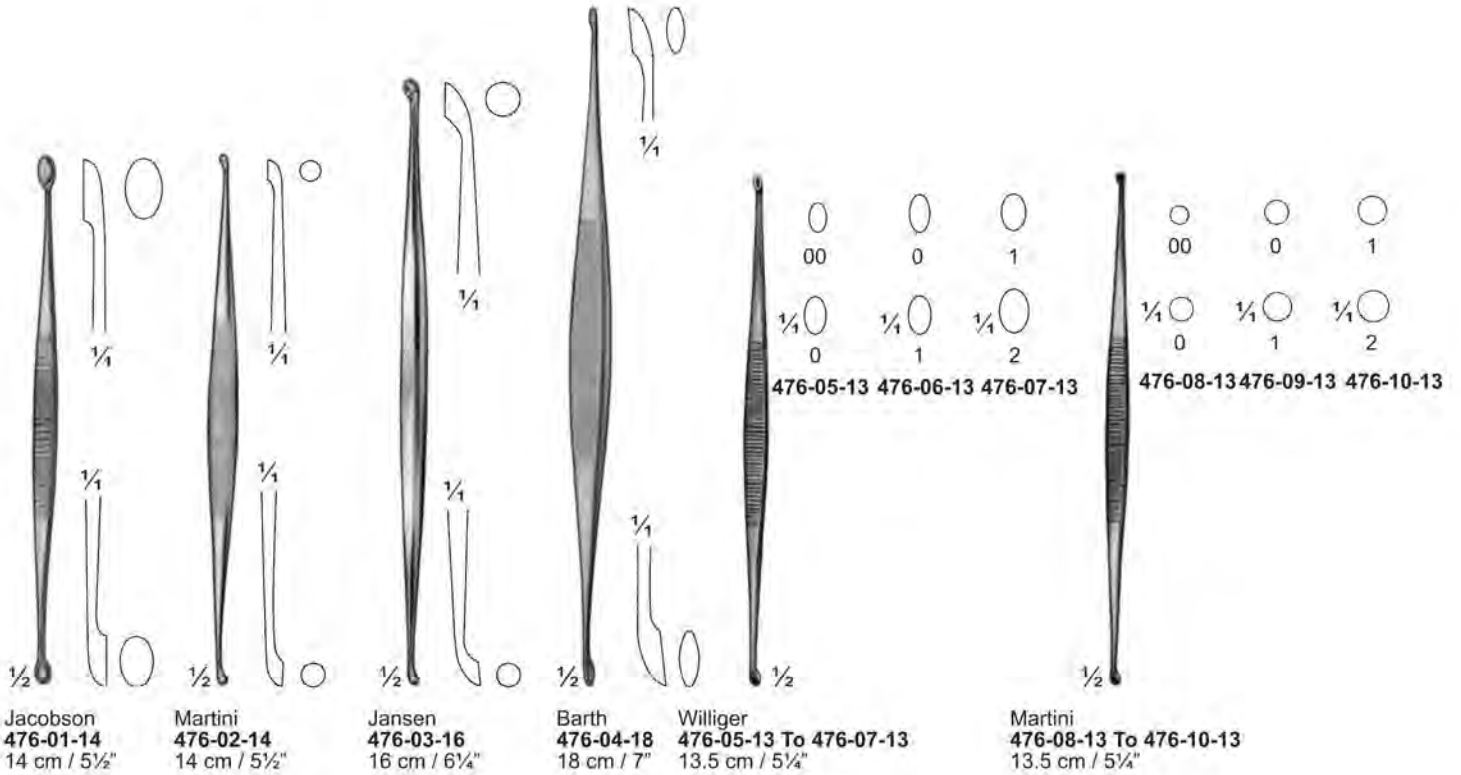

ScharfeLöffel, Küretten;Cucharillas cortantes  
 Bone Curettes ;Curette taglienti  
 Curettes tranchantes;Colheres amoladas

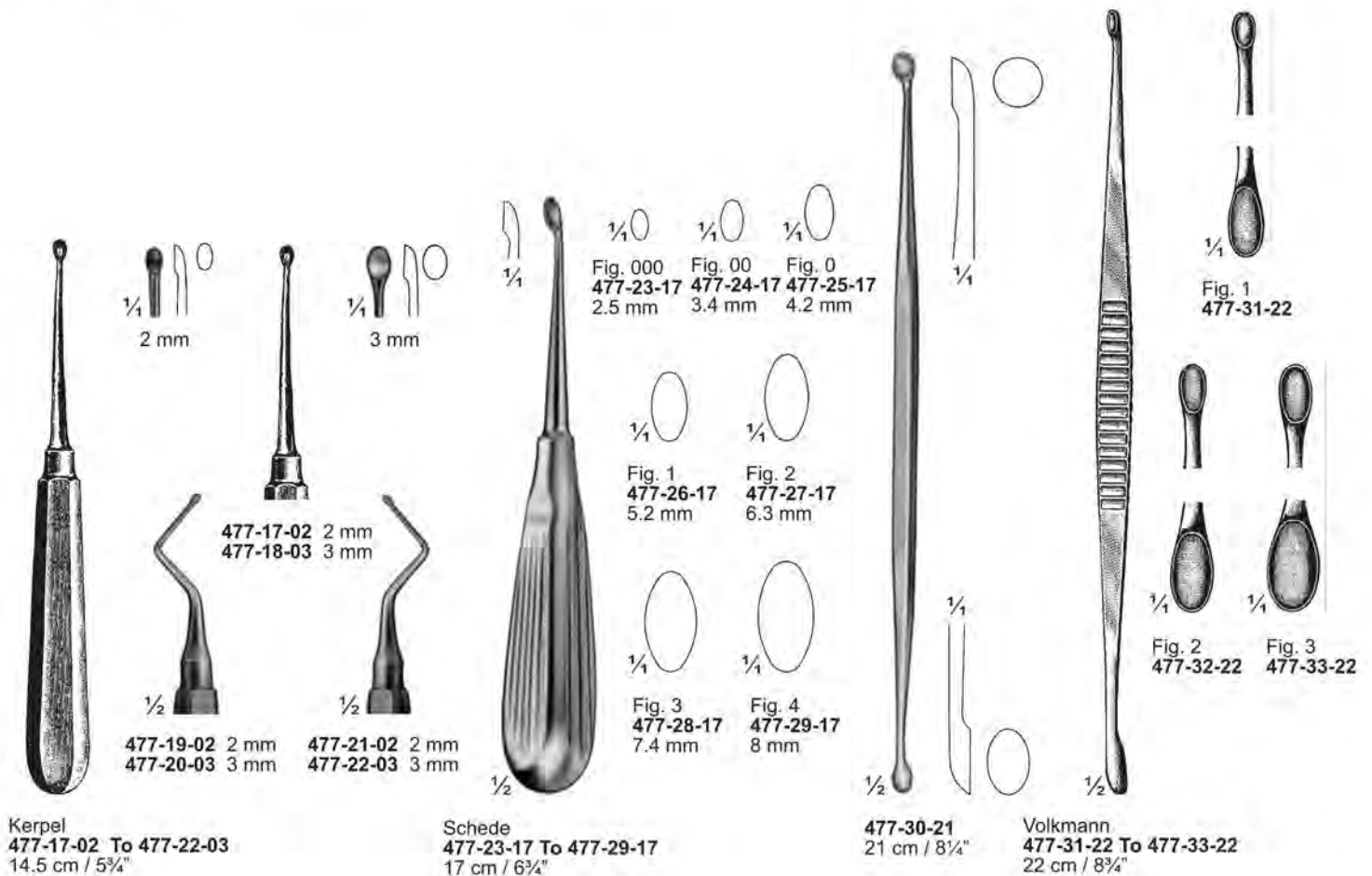
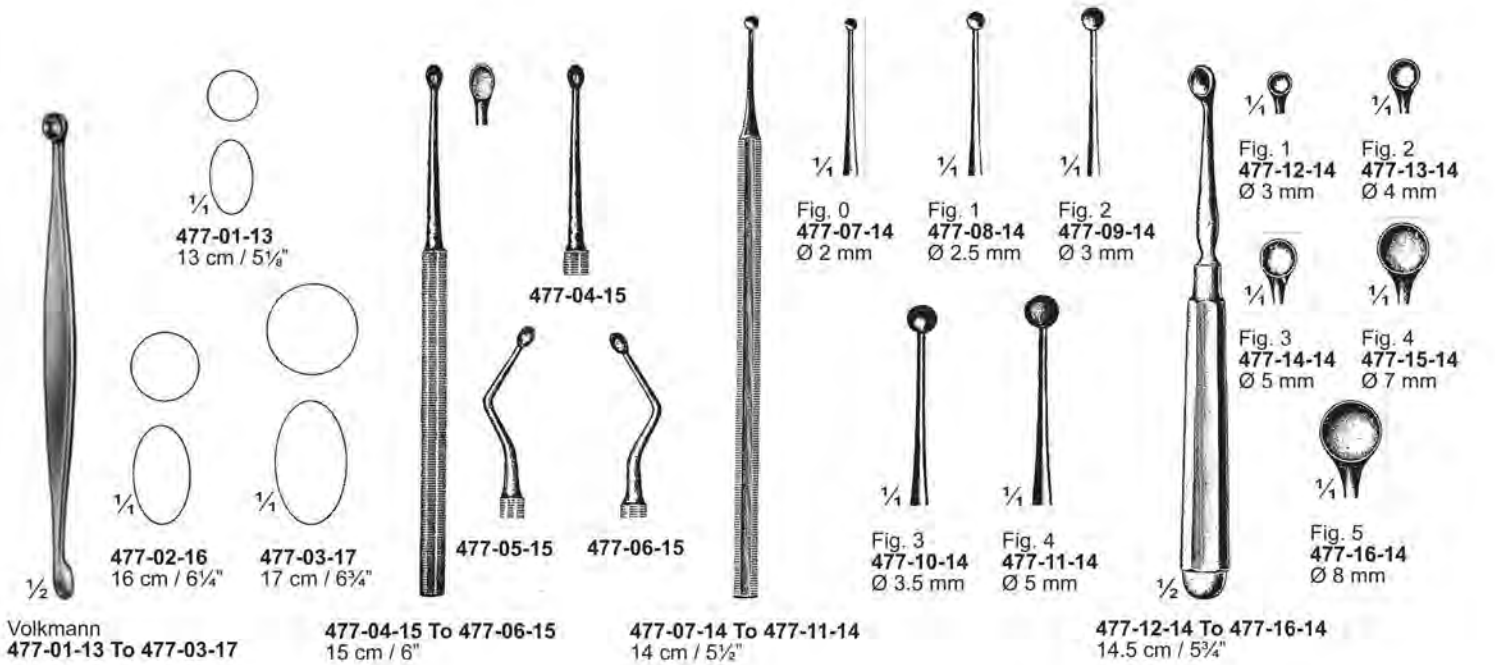

**ScharfeLöffel, Küretten;Cucharillas cortantes**  
**Bone Curettes ;Curette taglienti**  
**Curettes tranchantes;Colheres amoladas**



- |                        |                       |                      |
|------------------------|-----------------------|----------------------|
| $\frac{1}{4}$ ○        | $\frac{1}{4}$ ○       | $\frac{1}{4}$ ○      |
| Fig. 0000<br>478-01-17 | Fig. 000<br>478-02-17 | Fig. 00<br>478-03-17 |
| $\frac{1}{4}$ ○        | $\frac{1}{4}$ ○       | $\frac{1}{4}$ ○      |
| Fig. 0<br>478-04-17    | Fig. 1<br>478-05-17   | Fig. 2<br>478-06-17  |
| $\frac{1}{4}$ ○        | $\frac{1}{4}$ ○       | $\frac{1}{4}$ ○      |
| Fig. 3<br>478-07-17    | Fig. 4<br>478-08-17   | Fig. 5<br>478-09-17  |

**Bruns**  
478-01-17 To 478-10-17  
17 cm / 6 $\frac{3}{4}$ "

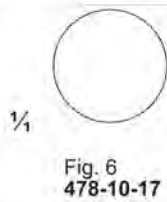

**Fig. 6**  
478-10-17



- |                        |                       |                      |
|------------------------|-----------------------|----------------------|
| $\frac{1}{4}$ ○        | $\frac{1}{4}$ ○       | $\frac{1}{4}$ ○      |
| Fig. 0000<br>478-11-17 | Fig. 000<br>478-12-17 | Fig. 00<br>478-13-17 |
| $\frac{1}{4}$ ○        | $\frac{1}{4}$ ○       | $\frac{1}{4}$ ○      |
| Fig. 0<br>478-14-17    | Fig. 1<br>478-15-17   | Fig. 2<br>478-16-17  |
| $\frac{1}{4}$ ○        | $\frac{1}{4}$ ○       | $\frac{1}{4}$ ○      |
| Fig. 3<br>478-17-17    | Fig. 4<br>478-18-17   | Fig. 5<br>478-19-17  |

**Spratt**  
478-11-17 To 478-19-17  
17 cm / 6 $\frac{3}{4}$ "



- |                                   |                 |
|-----------------------------------|-----------------|
| $\frac{1}{4}$ ○                   | $\frac{1}{4}$ ○ |
| Fig. 00<br>478-20-21<br>478-23-21 |                 |
| $\frac{1}{4}$ ○                   | $\frac{1}{4}$ ○ |
| Fig. 0<br>478-21-21<br>478-24-21  |                 |
| $\frac{1}{4}$ ○                   | $\frac{1}{4}$ ○ |
| Fig. 1<br>478-22-21<br>478-25-21  |                 |

**Halle**  
478-20-21 To 478-22-21  
21 cm / 8 $\frac{1}{4}$ "

**Halle**  
478-23-21 To 478-25-21  
21.5 cm / 8 $\frac{1}{2}$ "



**Uffenorde**  
478-26-17  
17 cm / 6 $\frac{3}{4}$ "

**Uffenorde**  
478-27-17  
17 cm / 6 $\frac{3}{4}$ "

- |  |   |  |
|--|---|--|
| $\frac{1}{4}$ ○                                  | $\frac{1}{4}$ ○                                   | $\frac{1}{4}$ ○                                  |
| 478-28-02<br>17 cm / 6 $\frac{3}{4}$ "<br>Ø 2 mm | 478-29-03<br>17 cm / 6 $\frac{3}{4}$ "<br>Ø 3 mm  | 478-30-04<br>17 cm / 6 $\frac{3}{4}$ "<br>Ø 4 mm |
| $\frac{1}{4}$ ○                                  | $\frac{1}{4}$ ○                                   | $\frac{1}{4}$ ○                                  |
| 478-31-05<br>18 cm / 7"<br>Ø 5 mm                | 478-32-06<br>18 cm / 7"<br>Ø 6 mm                 | 478-33-07<br>18 cm / 7"<br>Ø 7 mm                |
| $\frac{1}{4}$ ○                                  | $\frac{1}{4}$ ○                                   |  |
| 478-34-08<br>18 cm / 7"<br>Ø 8 mm                | 478-35-10<br>19 cm / 7 $\frac{1}{2}$ "<br>Ø 10 mm |  |
| $\frac{1}{4}$ ○                                  | $\frac{1}{4}$ ○                                   |  |
| 478-36-20<br>20 cm / 8"<br>Ø 12 mm               | 478-37-14<br>20 cm / 8"<br>Ø 14 mm                |  |

**478-28-02 To 478-37-14**



**ScharfeLöffel, Küretten;Cucharillas cortantes**  
**Bone Curettes ;Curette taglienti**  
**Curettes tranchantes;Colheres amoladas**

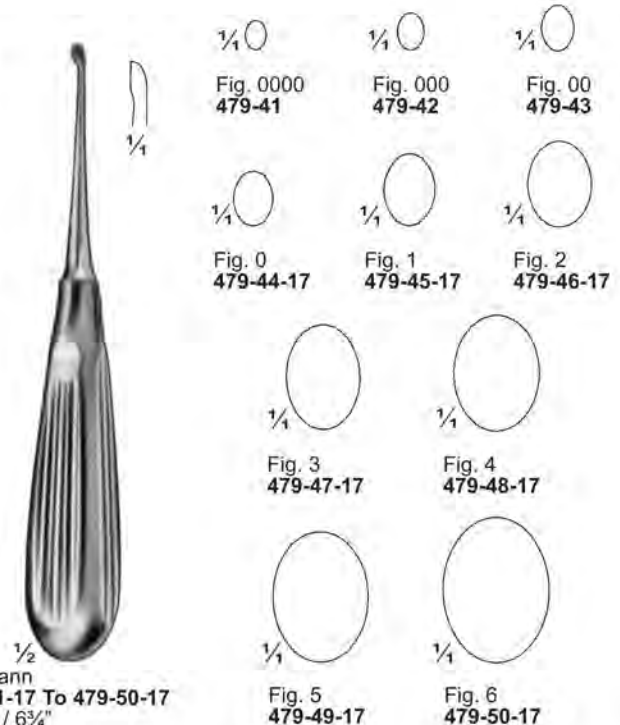
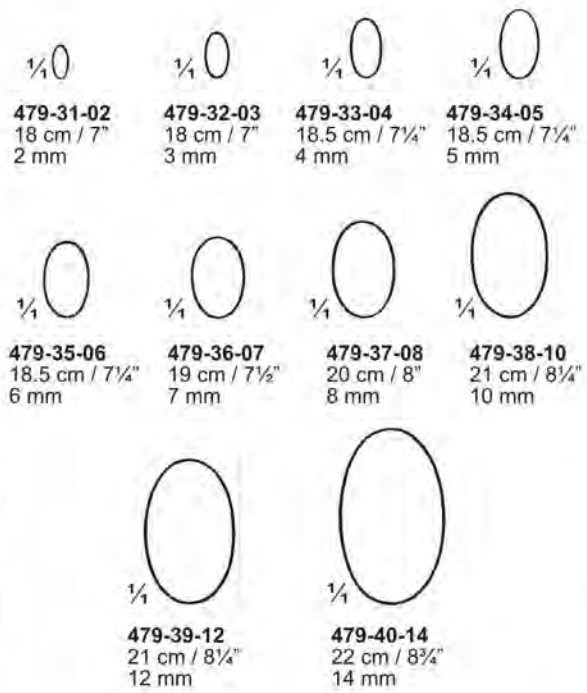
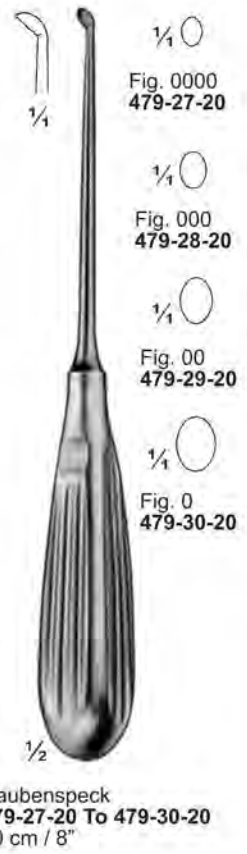
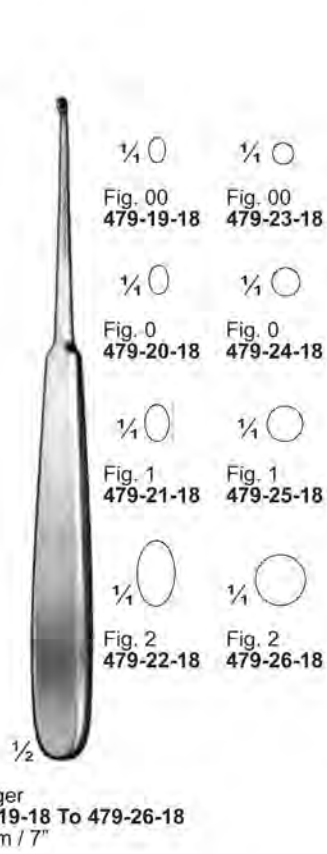
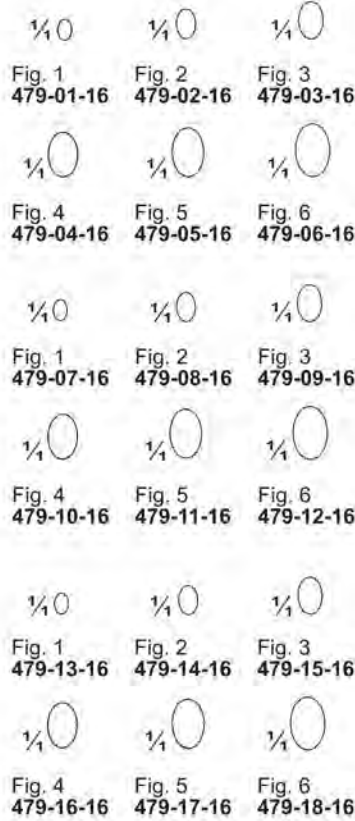
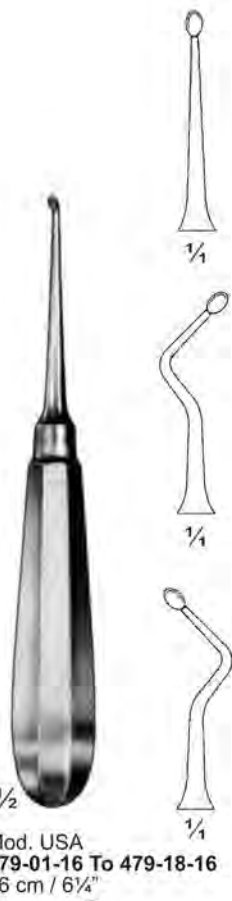





Scharfe Löffel, Küretten; Cucharillas cortantes  
 Bone Curettes ; Curette taglienti  
 Curettes tranchantes; Colheres amoladas



- |                |                |                |
|----------------|----------------|----------------|
| $\frac{1}{4}0$ | $\frac{1}{4}0$ | $\frac{1}{4}0$ |
| 480-01-23      | 480-02-23      | 480-03-23      |
| $\frac{1}{4}0$ | $\frac{1}{4}0$ | $\frac{1}{4}0$ |
| 480-04-23      | 480-05-23      | 480-06-23      |
| $\frac{1}{4}0$ | $\frac{1}{4}0$ | $\frac{1}{4}0$ |
| 480-07-23      | 480-08-23      | 480-09-23      |

Bruns  
 480-01-23 To 480-09-23  
 23 cm / 9"



- |               |               |               |               |               |
|---------------|---------------|---------------|---------------|---------------|
| $\frac{1}{4}$ | $\frac{1}{4}$ | $\frac{1}{4}$ | $\frac{1}{4}$ | $\frac{1}{4}$ |
| Fig. 0000     | Fig. 000      | Fig. 00       | Fig. 0        | Fig. 1        |
| 480-10-21     | 480-11-21     | 480-12-21     | 480-13-21     | 480-14-21     |
| 480-20-21     | 480-21-21     | 480-22-21     | 480-23-21     | 480-24-21     |
| $\frac{1}{4}$ | $\frac{1}{4}$ | $\frac{1}{4}$ | $\frac{1}{4}$ | $\frac{1}{4}$ |
| Fig. 2        | Fig. 3        | Fig. 4        | Fig. 5        | Fig. 6        |
| 480-15-21     | 480-16-21     | 480-17-21     | 480-18-21     | 480-19-21     |
| 480-25-21     | 480-26-21     | 480-27-21     | 480-28-21     | 480-29-21     |

Bruns (Volkmann)  
 480-10-21 To 480-19-21  
 21 cm / 8 $\frac{1}{4}$ "



Bruns (Volkmann)  
 480-20-21 To 480-29-21  
 21 cm / 8 $\frac{1}{4}$ "



- |               |               |               |               |
|---------------|---------------|---------------|---------------|
| $\frac{1}{4}$ | $\frac{1}{4}$ | $\frac{1}{4}$ | $\frac{1}{4}$ |
| Fig. 0000     | Fig. 000      | Fig. 00       | Fig. 0        |
| 480-30-17     | 480-31-17     | 480-32-17     | 480-33-17     |
| 480-40-27     | 480-41-27     | 480-42-27     | 480-43-27     |
| $\frac{1}{4}$ | $\frac{1}{4}$ | $\frac{1}{4}$ |               |
| Fig. 1        | Fig. 2        | Fig. 3        |               |
| 480-34-17     | 480-35-17     | 480-36-17     |               |
| 480-44-27     | 480-45-27     | 480-46-27     |               |
| $\frac{1}{4}$ | $\frac{1}{4}$ | $\frac{1}{4}$ |               |
| Fig. 4        | Fig. 5        | Fig. 6        |               |
| 480-37-17     | 480-38-17     | 480-39-17     |               |
| 480-47-27     | 480-48-27     | 480-49-27     |               |

Volkmann  
 480-30-17 To 480-39-17  
 17 cm / 6 $\frac{3}{4}$ "



Volkmann  
 480-40-27 To 480-49-27  
 27 cm / 10 $\frac{1}{2}$ "



Lempert  
 480-50-20 To 480-57-20  
 20 cm / 8"

- |                |                |
|----------------|----------------|
| $\frac{1}{4}0$ | $\frac{1}{4}0$ |
| Fig. 000000    | Fig. 00000     |
| 480-50-20      | 480-51-20      |
| $\frac{1}{4}0$ | $\frac{1}{4}0$ |
| Fig. 0000      | Fig. 000       |
| 480-52-20      | 480-53-20      |
| $\frac{1}{4}0$ | $\frac{1}{4}0$ |
| Fig. 00        | Fig. 0         |
| 480-54-20      | 480-55-20      |
| $\frac{1}{4}0$ | $\frac{1}{4}0$ |
| Fig. 1         | Fig. 2         |
| 480-56-20      | 480-57-20      |

**ScharfeLöffel, Küretten;Cucharillas cortantes  
Bone Curettes ;Curette taglienti  
Curettes tranchantes;Colheres amoladas**

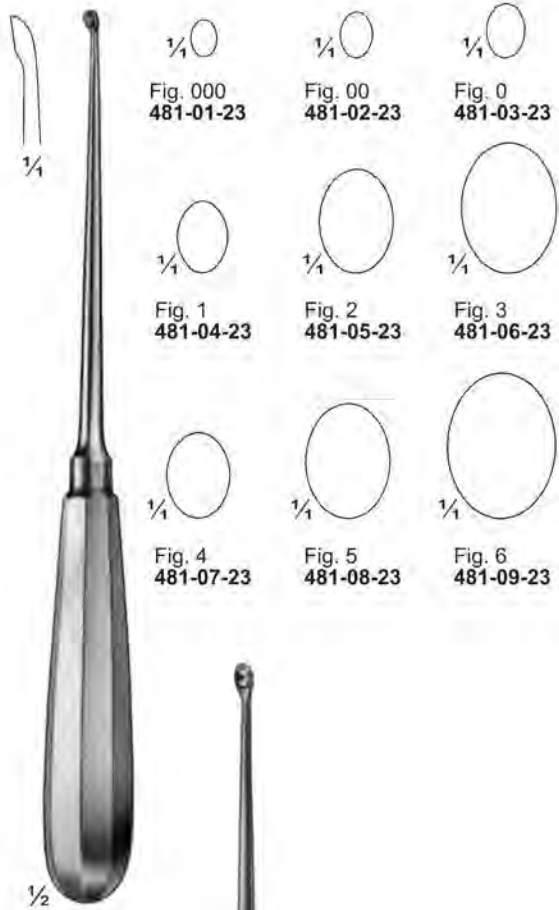

Simon  
481-01-23 To 481-09-23  
23.5 cm / 9 1/4"

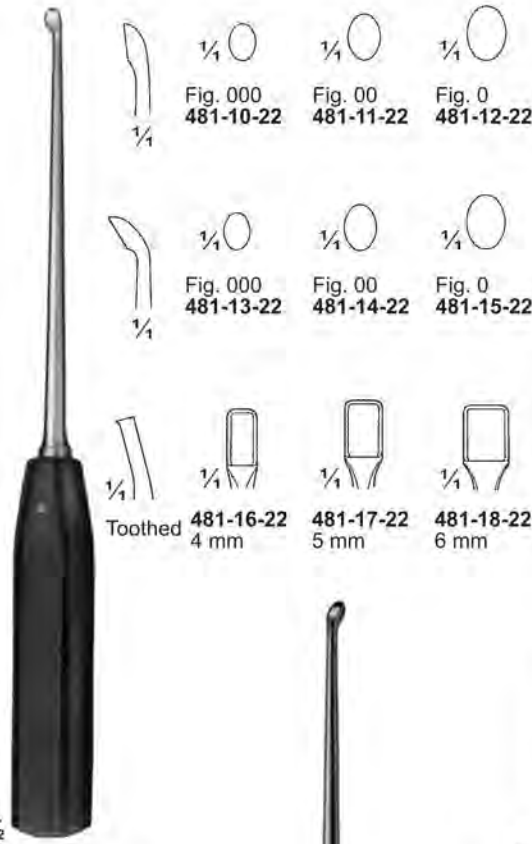

Caspar  
481-10-22 To 481-18-22  
22 cm / 8 3/4"



Caspar  
481-19 & 481-20  
25 cm / 10"



Volkmann  
481-21-25 To 481-32-25  
25 cm / 10"



Busche  
481-33-25 To 481-35-25  
25 cm / 10"

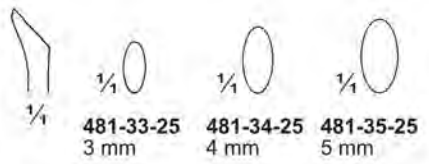
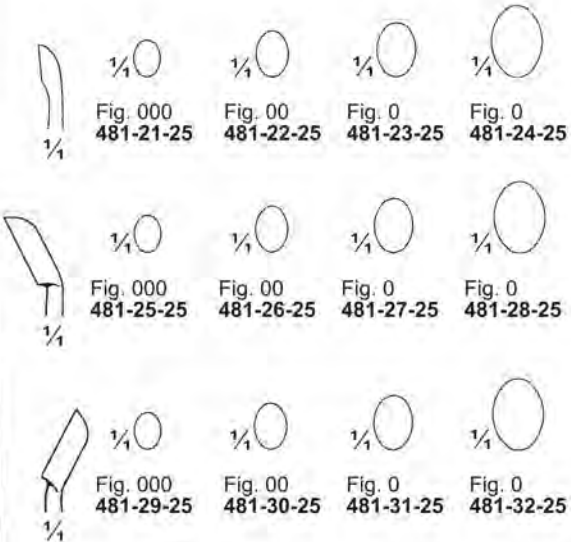



ScharfeLöffel, Küretten;Cucharillas cortantes  
 Bone Curettes ;Curette taglienti  
 Curettes tranchantes;Colheres amoladas

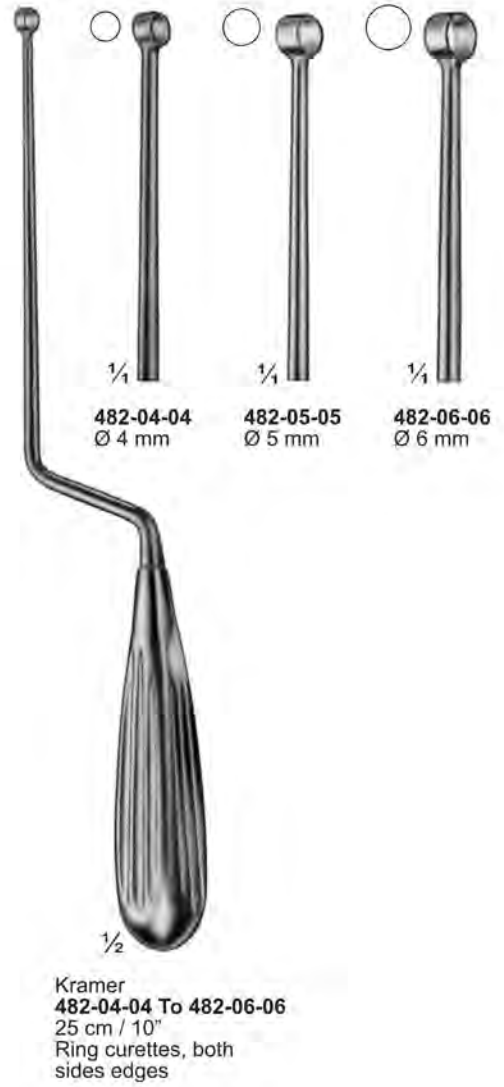



**ScharfeLöffel, Küretten;Cucharillas cortantes  
Bone Curettes ;Curette taglianti  
Curettes tranchantes;Colheres amoladas**

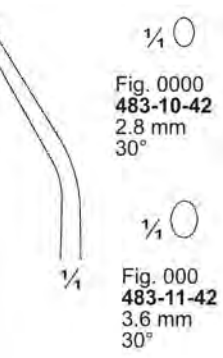
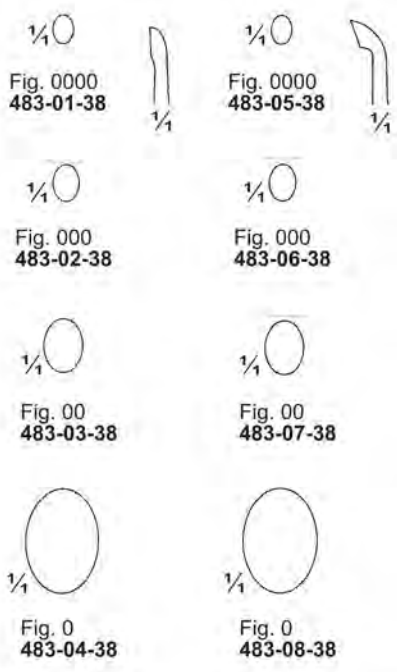

Sypert  
483-01-38 To 483-08-38  
38 cm / 15"

Sypert  
483-09-42  
42.5 cm / 17"

Sypert  
483-10-42 & 483-11-42  
42.5 cm / 17"

**Knochensplitterzangen ; Pinzas cortantes para huesos  
 Bone Cutting Forceps ; Cesioie per ossa  
 Pincers coupantes à os ; Pinças cortantes para ossos**



**484-01-12**  
12 cm / 4 3/4"



**484-02-13**  
13 cm / 5 1/4"



**484-03-13**  
13.5 cm / 5 1/4"

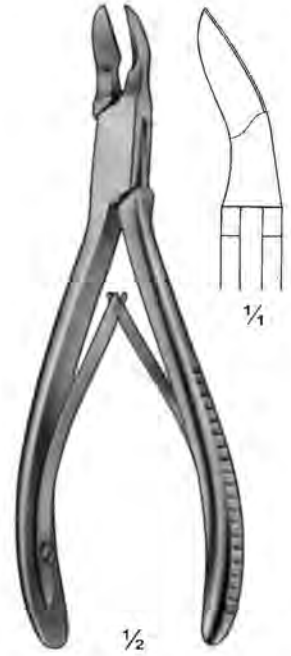

**484-04-17**  
17 cm / 6 3/4"



**Cleveland**  
**484-05-15**  
15 cm / 6"

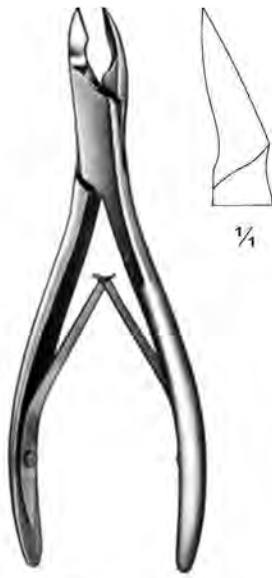

**Cleveland**  
**484-06-17**  
17 cm / 6 3/4"



**Cleveland**  
**484-07-16 & 484-08-16**  
16 cm / 6 1/4"

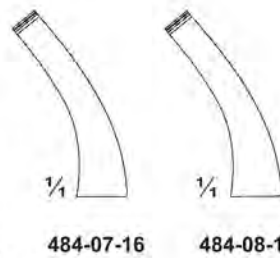

**484-07-16**

**484-08-16**

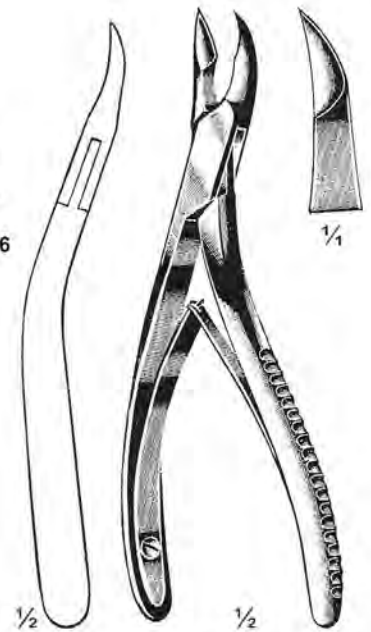

**484-09-17**  
17 cm / 6 3/4"

**Knochensplitterzangen ; Pinzas cortantes para huesos  
Bone Cutting Forceps ; Cesoiè per ossa  
Pinces coupantes à os ; Pinças cortantes para ossos**

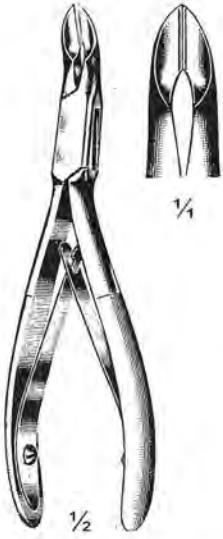

Niro  
485-01-14  
14 cm / 5½"



Littauer-Liston  
485-02-15  
15 cm / 6"



485-03-16  
16 cm / 6¼"



485-04-14  
14 cm / 5½"



Horsley  
485-05-19  
19 cm / 7½"

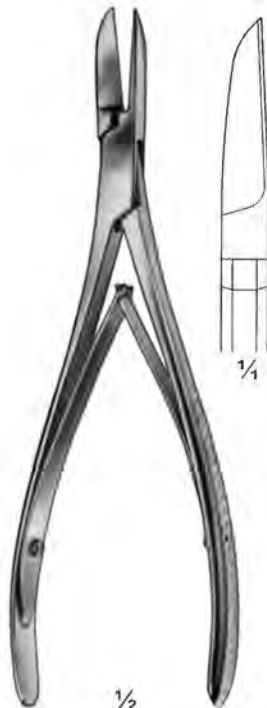

Kazanjan  
485-06-18  
18.5 cm / 7¼"

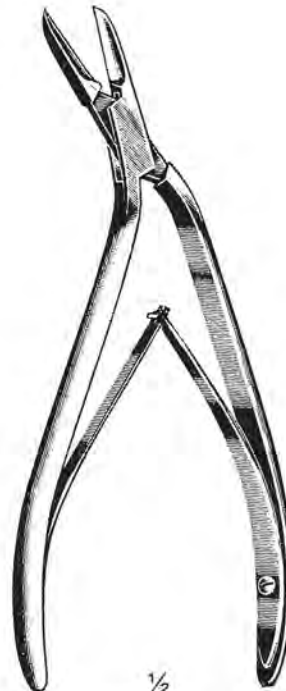

Cottle  
485-07-18  
18 cm / 7"



485-08-19  
19.5 cm / 7¾"

**Knochensplitterzangen ; Pinzas cortantes para huesos  
 Bone Cutting Forceps ; Cesioie per ossa  
 Pinces coupantes à os ; Pinças cortantes para ossos**



Stamm  
 486-01-15  
 15 cm / 6"

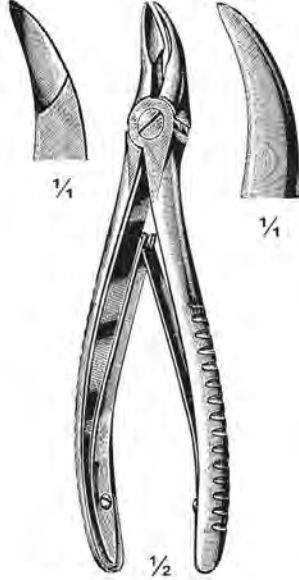

486-02-15  
 15 cm / 6"



Horsley  
 486-03-20  
 20 cm / 8"



Markwalder  
 486-04-20  
 20 cm / 8"



486-05-19 & 486-06-23

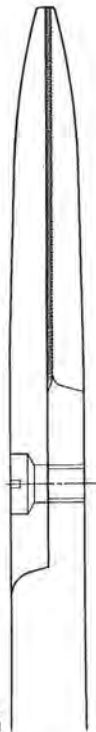

486-05-19  
 19.5 cm / 7 3/4"

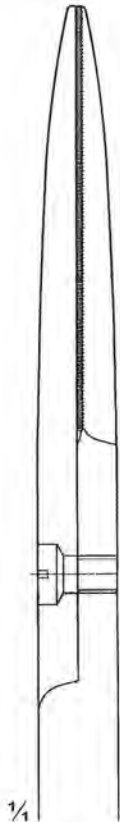

486-06-23  
 23 cm / 9"



Liston  
 486-07-14 To 486-10-22



486-07-14  
 14 cm / 5 1/2"



486-08-17  
 17 cm / 6 3/4"



486-09-20  
 20 cm / 8"

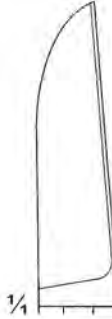

486-10-22  
 22 cm / 8 3/4"



Liston  
 486-11-14 14 cm / 5 1/2"  
 486-12-17 17 cm / 6 3/4"  
 486-13-20 20 cm / 8"  
 486-14-22 22 cm / 8 3/4"

**Knochensplitterzangen ; Pinzas cortantes para huesos  
 Bone Cutting Forceps ; Cesioie per ossa  
 Pinces coupantes à os ; Pinças cortantes para ossos**



Liston  
 487-01-14 To 487-04-22



487-01-14  
 14 cm / 5½"



487-02-17  
 17 cm / 6¾"



487-03-20  
 20 cm / 8"

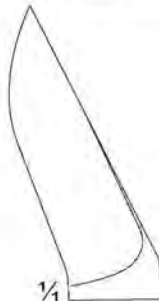

487-04-22  
 22 cm / 8¾"



487-05-15 & 487-06-15



487-05-15  
 15 cm / 6"



487-06-15  
 15 cm / 6"



487-07-15  
 15 cm / 6"



Ruskin-Liston  
 487-08-19 & 487-09-19  
 19 cm / 7½"



487-08-19



487-09-19



Ruskin-Rowland  
 487-10-18  
 18 cm / 7"



Ruskin-Rowland  
 487-11-18  
 18 cm / 7"



**Knochensplitterzangen ; Pinzas cortantes para huesos  
 Bone Cutting Forceps ; Cesoie per ossa  
 Pinces coupantes à os ; Pinças cortantes para ossos**

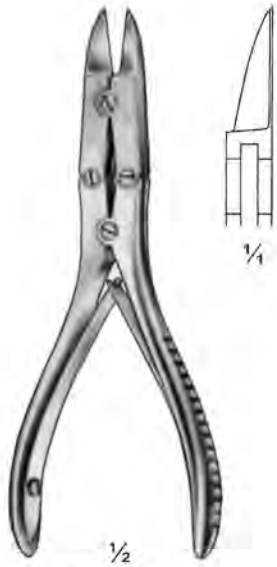

Bohler  
**488-01-14**  
 14.5 cm / 5 3/4"

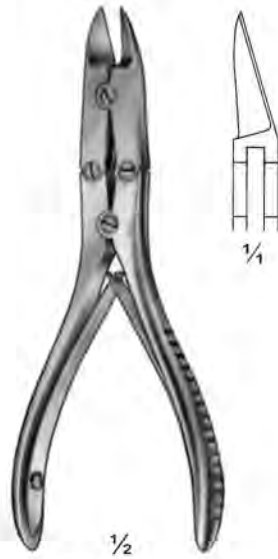

Bohler  
**488-02-14**  
 14.5 cm / 5 3/4"

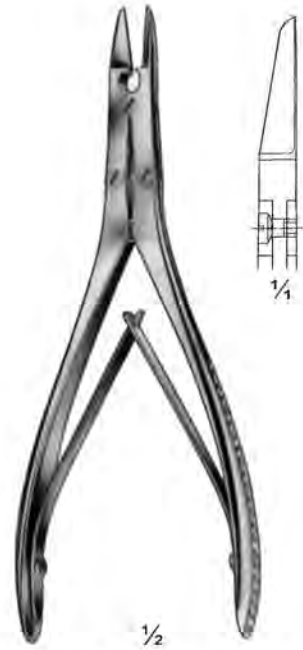

**488-03-17**  
 17 cm / 6 3/4"



McIndoe  
**488-04-18 & 488-05-18**  
 18 cm / 7"



**488-05-18**

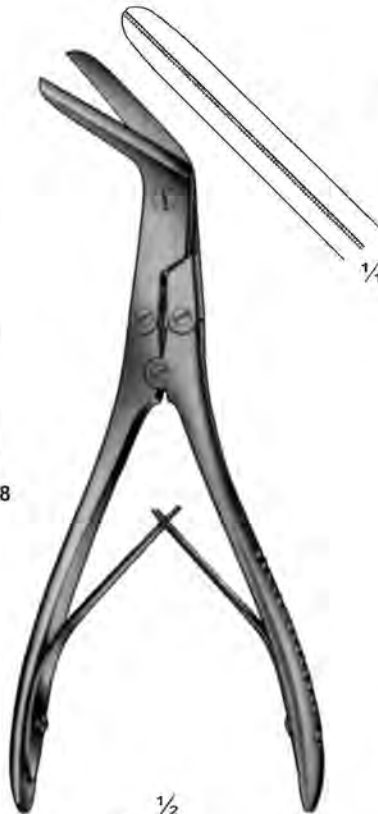

$\frac{1}{2}$   
 Killian  
**488-06-20**  
 20 cm / 8"



Muhling  
**488-07-21**  
 21 cm / 8 1/4"

**Knochensplitterzangen ; Pinzas cortantes para huesos  
 Bone Cutting Forceps ; Cesoiè per ossa  
 Pincès coupantes à os ; Pinças cortantes para ossos**

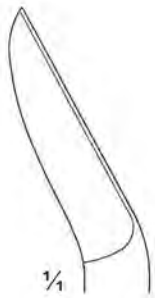

1/4

**489-01-23** 23 cm / 9" Str

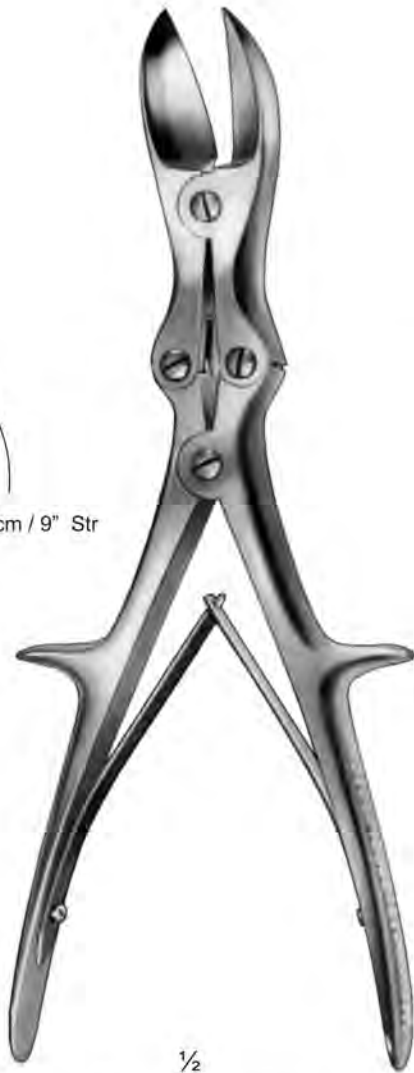

1/2

Liston  
**489-01-23 To 489-04-27**



1/4

**489-04-27**  
 27 cm / 10 1/2"



1/4

1/2

Liston-Stillè  
**489-05-27**  
 27 cm / 10 1/2"

**Knochensplitterzangen ; Pinzas cortantes para huesos  
 Bone Cutting Forceps ; Cesoiè per ossa  
 Pinces coupantes à os ; Pinças cortantes para ossos**



½  
 Liston-Key-Horsley  
 490-01-25  
 25 cm / 10"



½  
 Semb  
 490-02-24  
 24 cm / 9½"



Tudor-Edwards  
 490-03-23  
 23 cm / 9"

Hohlmeißelzangen ; Pinzas goubias, Cizallas  
 Bone Rongeurs ; Pinze sgorbie  
 Pincas -gouges ; Pinças goivas, Cizalhas

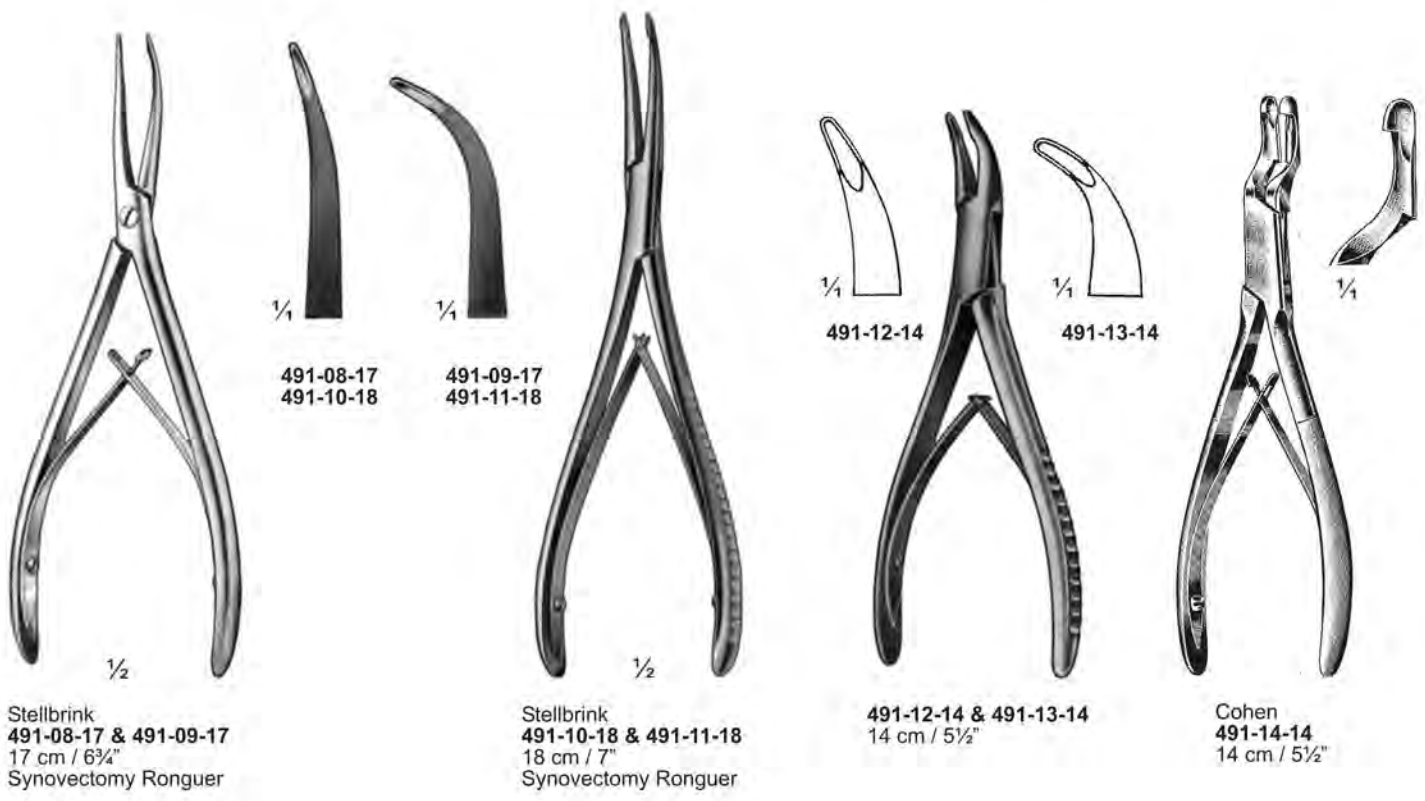
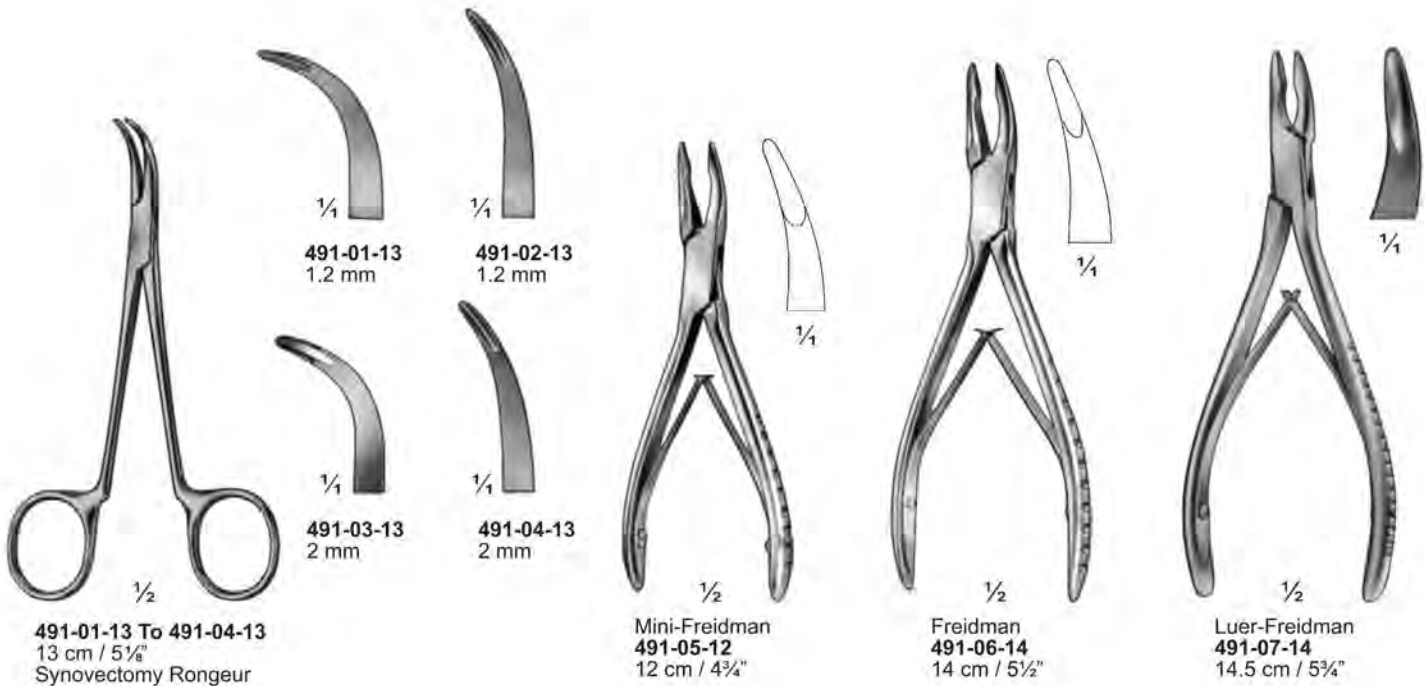

Hohlmeißelzangen ; Pinzas goubias, Cizallas  
 Bone Rongeurs ; Pinze sgorbie  
 Pincas -gouges ; Pinças goivas, Cizalhas



492-01-14  
14 cm / 5½"



Luer  
492-02-15 To 492-04-15  
15 cm / 6"

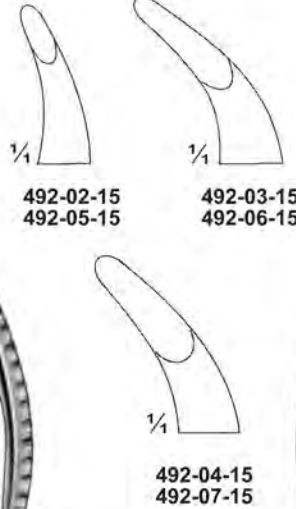

Luer  
492-05-15 To 492-07-15  
15 cm / 6"



Beyer  
492-08-17 & 492-09-17  
17 cm / 6¾"



Luer  
492-10-18 & 492-11-18  
18 cm / 7"



Luer  
492-12-18 & 492-13-18  
18 cm / 7"



Fisch  
492-14-17 & 492-15-17  
17 cm / 6¾"

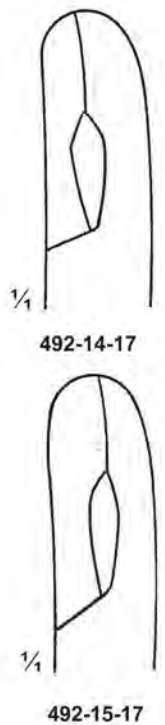

Hohlmeißelzangen ; Pinzas goubias, Cizallas  
 Bone Rongeurs ; Pinze sgorbie  
 Pincas -gouges ; Pinças goivas, Cizalhas

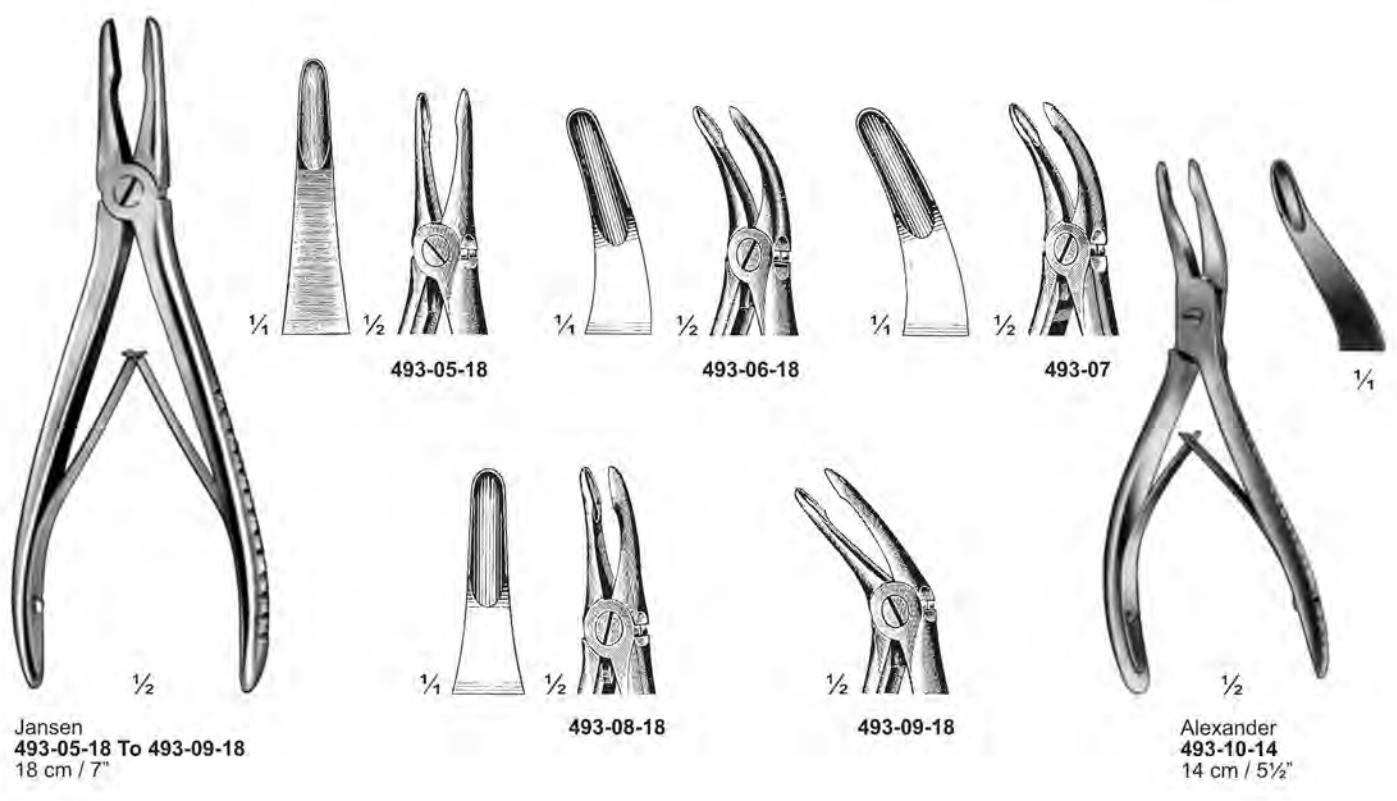
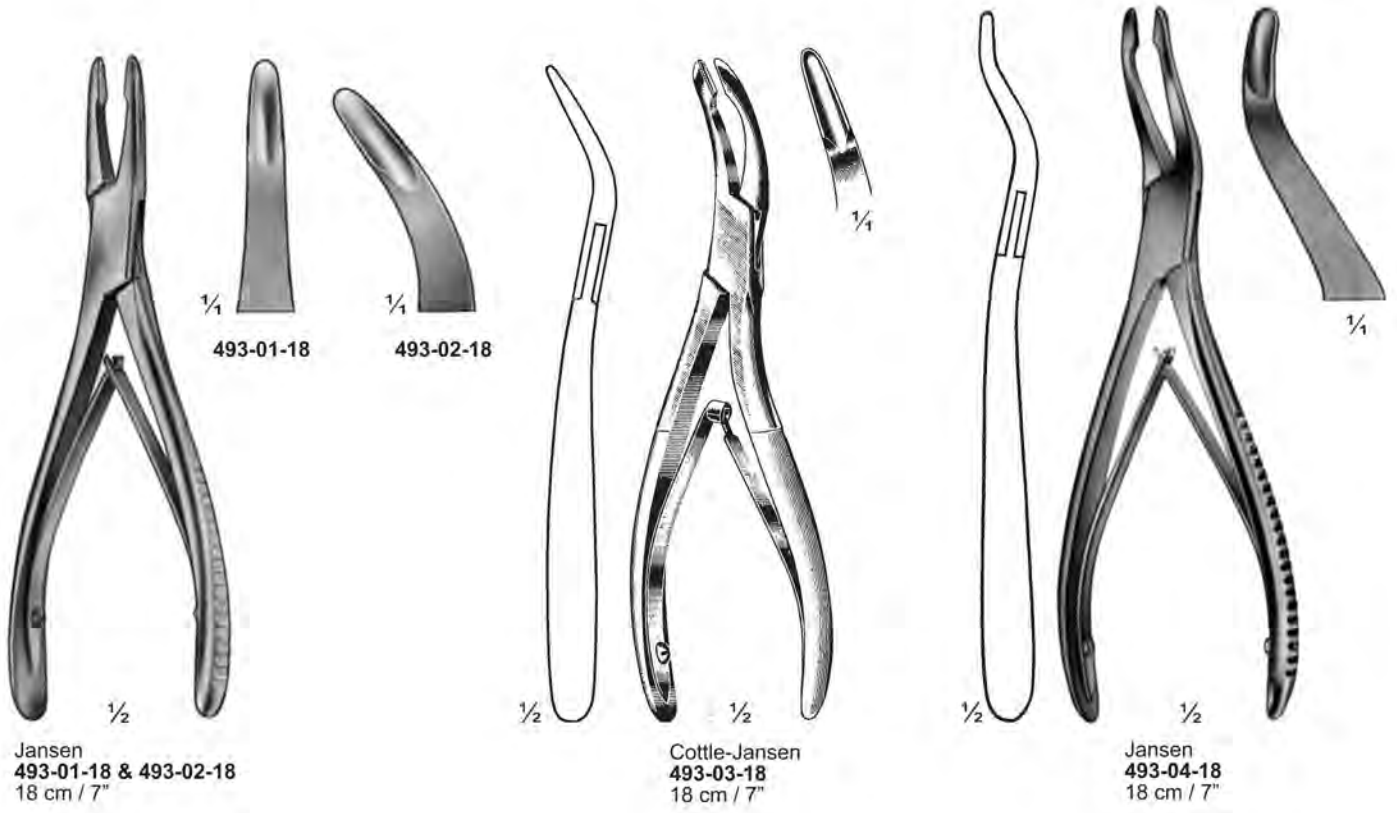

Hohlmeißelzangen ; Pinzas goubias, Cizallas  
 Bone Rongeurs ; Pinze sgorbie  
 Pincers -gouges ; Pinças goivas, Cizalhas



Universal  
 494-01-13  
 13.5 cm / 5 1/4"

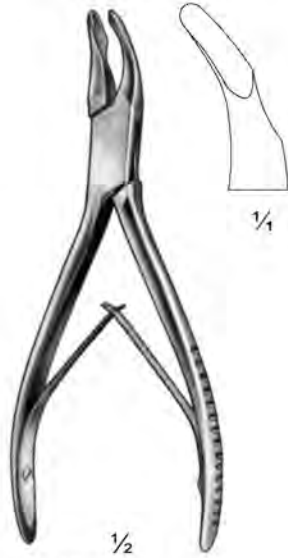

Cleveland  
 494-02-14  
 14 cm / 5 1/2"



Cleveland  
 494-03-17  
 17 cm / 6 3/4"

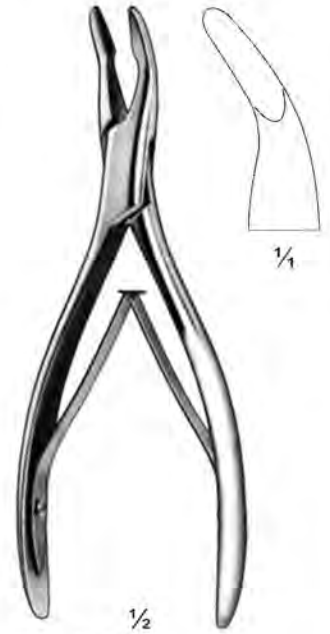

Mead  
 494-04-16  
 16.5 cm / 6 1/2"



Lempert  
 494-05-20 & 494-06-20  
 20 cm / 8"



Bacon  
 494-07-20  
 20 cm / 8"



Trotter  
 494-08-20  
 20 cm / 8"



Hohlmeißelzangen ; Pinzas goubias, Cizallas  
 Bone Rongeurs ; Pinze sgorbie  
 Pincas -gouges ; Pinças goivas, Cizalhas

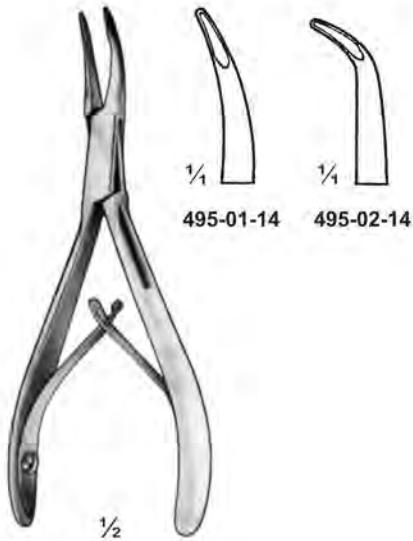

Kleinert-Kutz  
 495-01-14 & 495-02-14  
 14 cm / 5½"



Mead  
 495-03-14 To 495-06-17



Mead  
 495-07-16  
 16.5 cm / 6½"

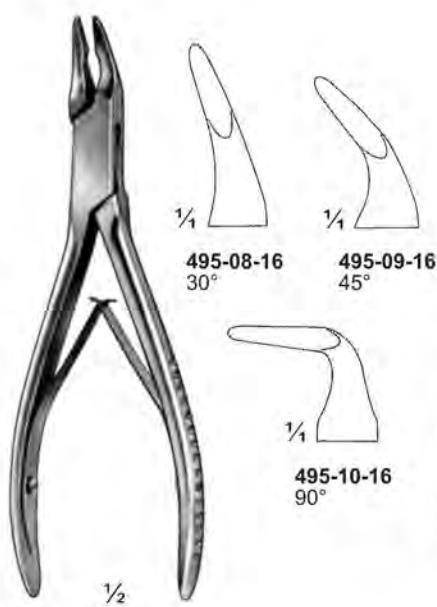

Blumenthal  
 495-08-16 To 495-10-16  
 16 cm / 6¼"



Hakansson  
 495-11-17  
 17 cm / 6¾"



Zaufal  
 495-12-18 Str  
 495-13-18 Cur  
 18 cm / 7"



Zaufal  
 495-14-18 Str  
 495-15-18 Cur  
 18 cm / 7"



Hohlmeißelzangen ; Pinzas goubias, Cizallas  
 Bone Rongeurs ; Pinze sgorbie  
 Pincas -gouges ; Pinças goivas, Cizalhas



Bane  
496-01-18  
18 cm / 7"

Lempert  
496-02-19  
19 cm / 7 1/2"

Guleke  
496-03-20  
20 cm / 8"

Olivecrona  
496-04-20  
20 cm / 8"

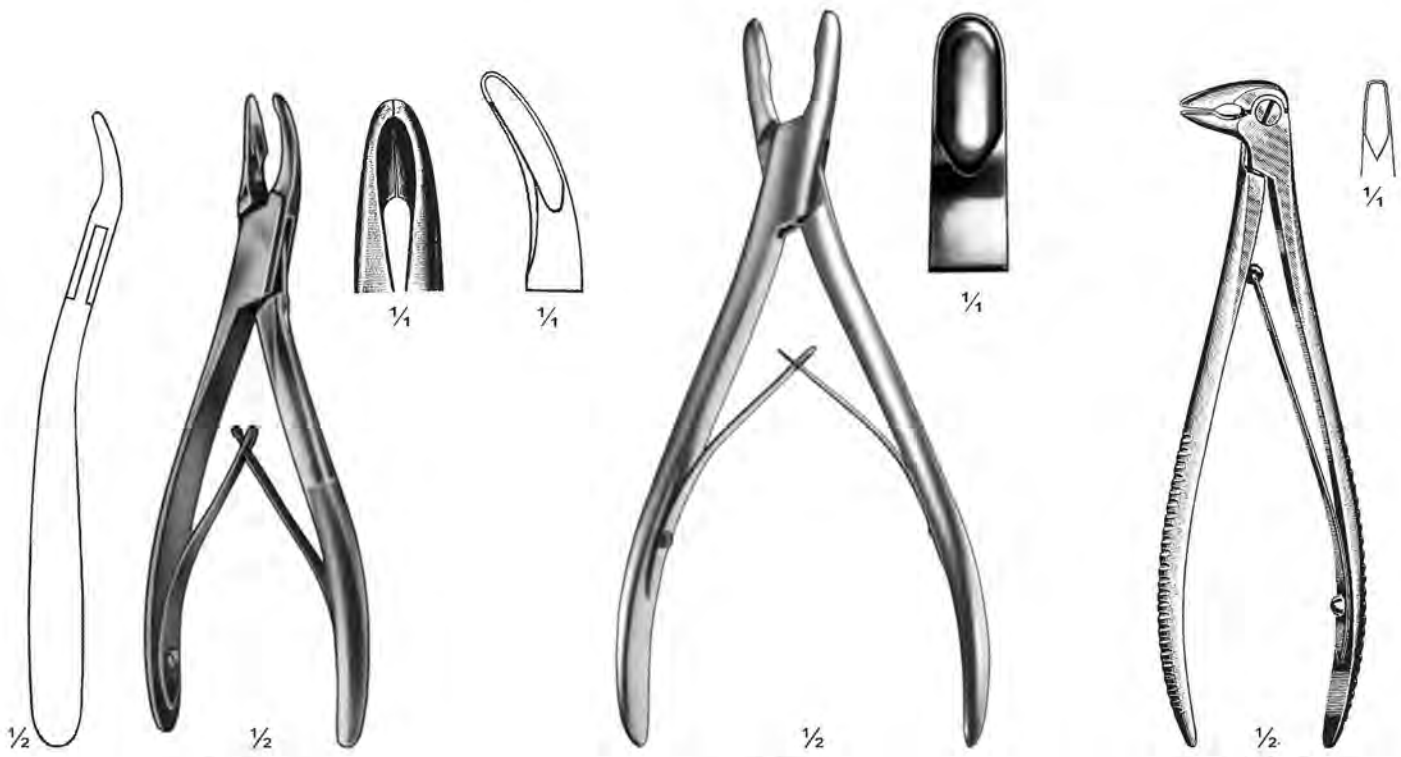

Schell  
496-05-17  
17 cm / 6 3/4"

Adson  
496-06-21  
21 cm / 8 1/4"

496-07-18  
18 cm / 7"

Hohlmeißelzangen ; Pinzas goubias, Cizallas  
 Bone Rongeurs ; Pinze sgorbie  
 Pincas -gouges ; Pinças goivas, Cizalhas



Bohler  
 497-01-15 To 497-04-15  
 15 cm / 6"



1/4  
 497-01-15



1/4  
 497-02-15



1/4  
 497-03-15



1/4  
 497-04-15



Ruskin-Mini  
 497-05-15 To 497-08-15  
 15 cm / 6"



1/4  
 497-05-15  
 2 mm

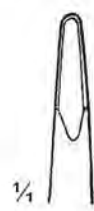

1/4  
 497-06-15  
 3 mm



1/4  
 497-07-15  
 2 mm



1/4  
 497-08-15  
 3 mm



Marquardt  
 497-09-20  
 20 cm / 8"



1/4



Ruskin  
 497-10-18 & 497-11-18  
 18 cm / 7"



1/4  
 497-10-18



1/4  
 497-11-18



Ruskin  
 497-12-18  
 18 cm / 7"



1/4



Rottgen-Ruskin  
 497-13-24 & 497-14-24  
 24 cm / 9 1/2"



1/4  
 497-13-24



1/4  
 497-14-24

Hohlmeißelzangen ; Pinzas goubias, Cizallas  
 Bone Rongeurs ; Pinze sgorbie  
 Pincas -gouges ; Pinças goivas, Cizalhas



1/2  
 Mayfield  
 498-01-18  
 18 cm / 7"



1/2  
 Beyer  
 498-02-18  
 18 cm / 7"



1/2  
 Zaufal-Jansen  
 498-03-18  
 18 cm / 7"



Kleinert-Kutz  
 498-04-15  
 15 cm / 6"



Geiger  
 498-05-15  
 15 cm / 6"



Peiper-Beyer  
 498-06-18  
 18 cm / 7"

Hohlmeißelzangen ; Pinzas goubias, Cizallas  
 Bone Rongeurs ; Pinze sgorbie  
 Pincas -gouges ; Pinças goivas, Cizalhas



Echlin  
 499-01-23 To 499-03-23  
 23 cm / 9"

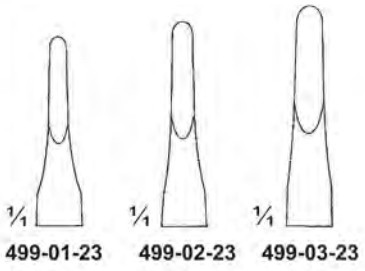

499-01-23 499-02-23 499-03-23

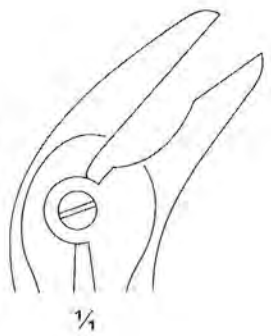

Frykholm  
 499-04-24  
 24 cm / 9 1/2"

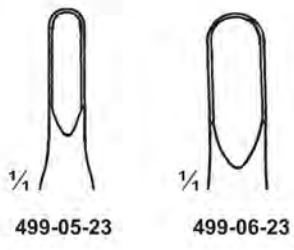

499-05-23 499-06-23



Stille-Leksell  
 499-05-23 & 499-06-23  
 23 cm / 9"

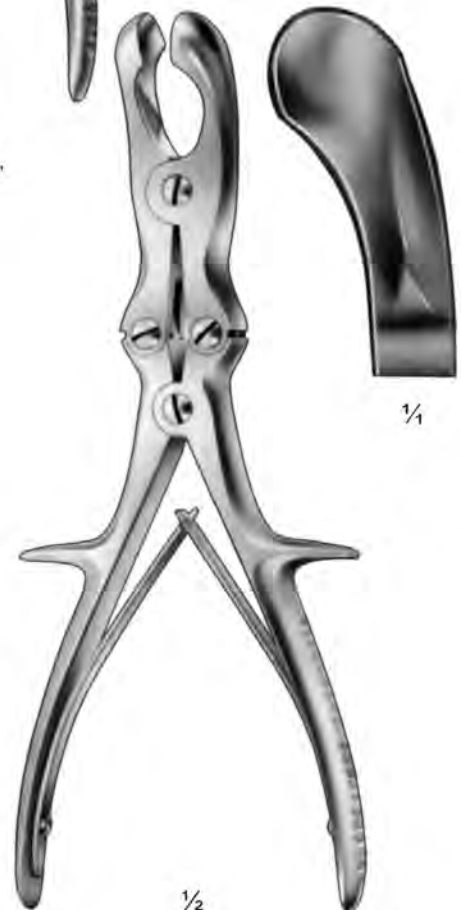

Semb  
 499-07-23 23 cm / 9"  
 499-08-27 27 cm / 10 1/2"





Hohlmeißelzangen ; Pinzas goubias, Cizallas  
 Bone Rongeurs ; Pinze sgorbie  
 Pincas -gouges ; Pinças goivas, Cizalhas

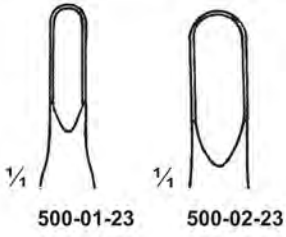

Leksell  
 500-01-23 & 500-02-23  
 23 cm / 9"

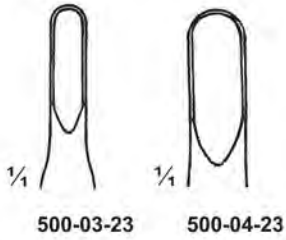

Leksell  
 500-03-23 & 500-04-23  
 23 cm / 9"



Smith-Petersen  
 500-05-24  
 24 cm / 9 1/2"



Stille  
 500-06-23  
 23.5 cm / 9 1/4"

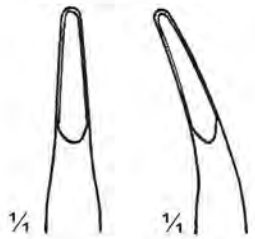

Smith-Petersen  
 500-07-24 & 500-08-24  
 24 cm / 9 1/2"

Hohlmeißelzangen  
Bone Rongeurs  
Pincès-gouges



501-01-22



501-02-22

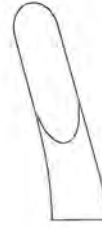

1/4

1/2  
Stille-Ruskin  
501-03-23  
23 cm / 9"



1/4

1/2  
Sybert  
501-08-36  
36 cm / 14 1/2"

1/2  
Stille-Luer  
501-01-22 To 501-02-22  
22 cm / 8 3/4"

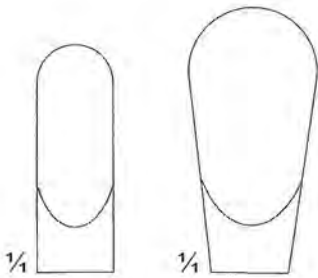

1/4  
501-04-23  
23 cm / 9"

1/4  
501-05-27  
27 cm / 10 1/2"



1/2  
Stille-Luer  
501-04-23 To 501-07-27

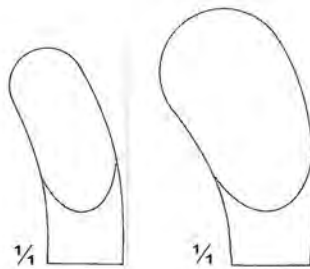

1/4  
501-06-23  
23 cm / 9"

1/4  
501-07-27  
27 cm / 10 1/2"

Hohlmeißelzangen  
Bone Rongeurs  
Pincès-gouges



1/2  
Sauerbruch-Stille  
502-01-26  
26 cm / 10 1/4"

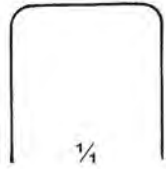

1/2  
Sauerbruch-Stille  
502-02-26  
26 cm / 10 1/4"



502-04-31



502-05-31



1/2  
Markwalder  
502-03-19  
19 cm / 7 1/2"



Rib rongeur



1/2  
Sauerbruch-Coryllos  
502-04-31 To 502-05-31  
31 cm / 12 1/4"

Sehnenfazzangen  
Bone Holding Forceps  
Pincés pour saisir les tendons

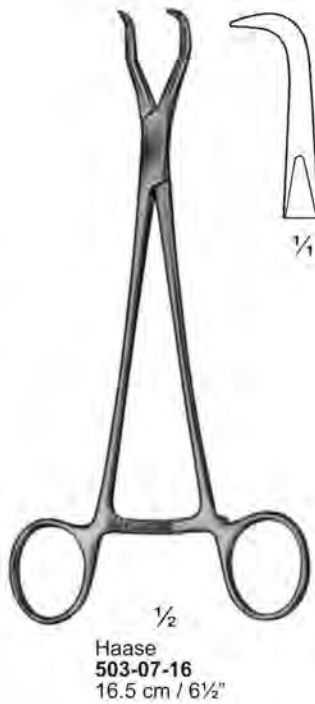
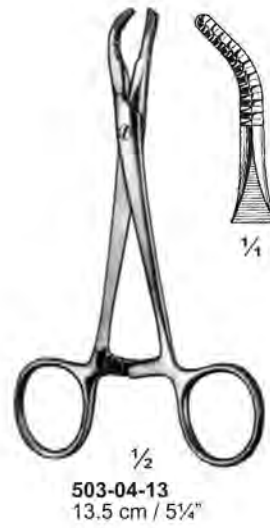



**Sehnenfazzangen**  
**Bone Holding Forceps**  
**Pinces pour saisir les tendons**



$\frac{1}{2}$   
**504-01-14**  
 14 cm / 5½"

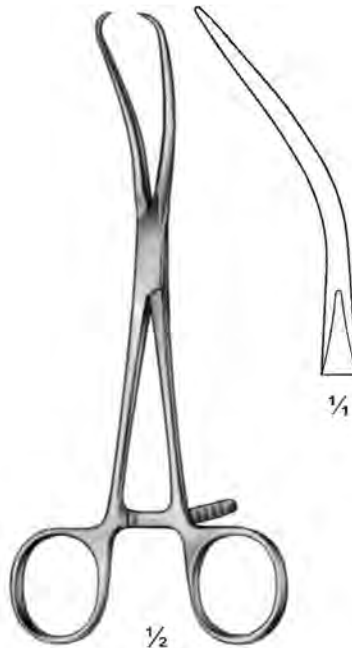

$\frac{1}{2}$   
 Reill  
**504-02-17**  
 17 cm / 6¾"

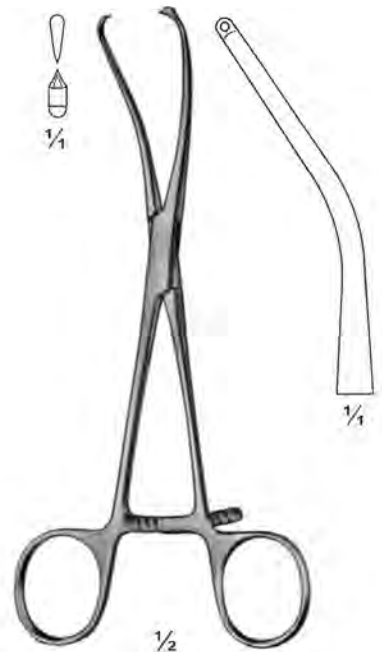

$\frac{1}{2}$   
 Meyer  
**504-03-17**  
 17 cm / 6¾"

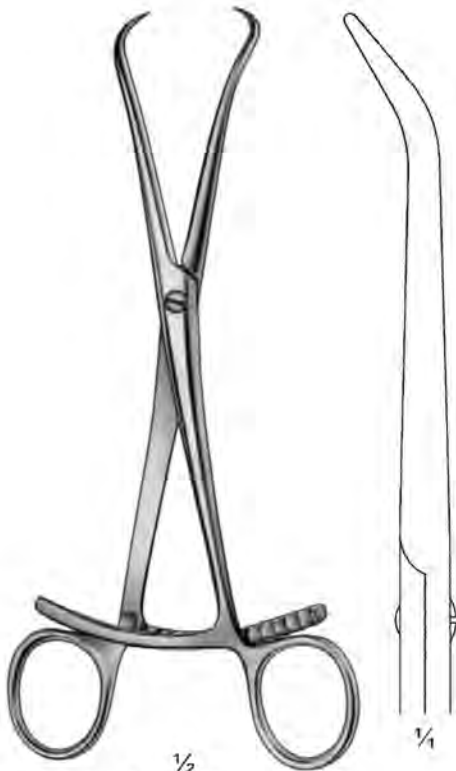

$\frac{1}{2}$   
**504-04-20**  
 20 cm / 8"

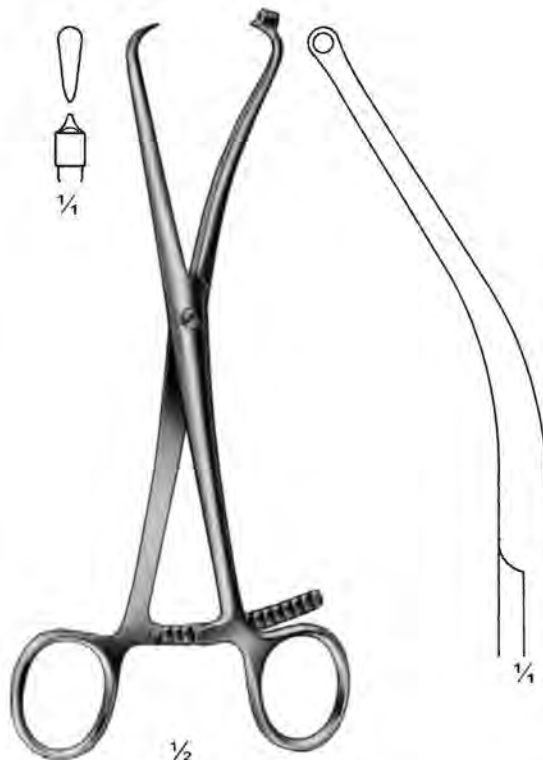

$\frac{1}{2}$   
 Meyer  
**504-05-20**  
 20 cm / 8"



$\frac{1}{2}$   
**504-06-21**  
 21 cm / 8¼"

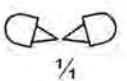

**Sehnenfazzangen  
Bone Holding Forceps  
Pincers pour saisir les tendons**

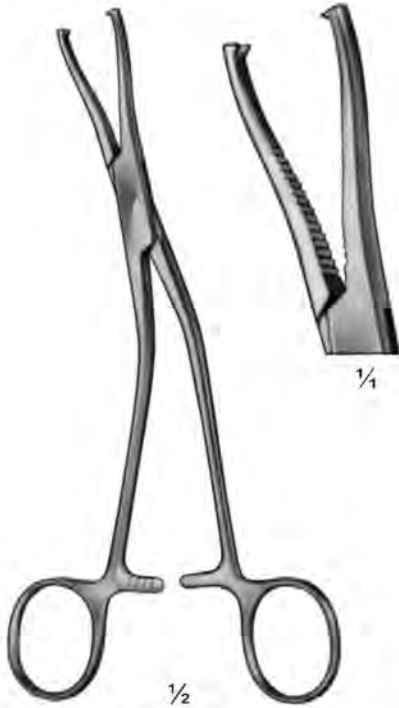

$\frac{1}{2}$   
Dingmann  
505-01-18  
18.5 cm / 7 $\frac{1}{4}$ "

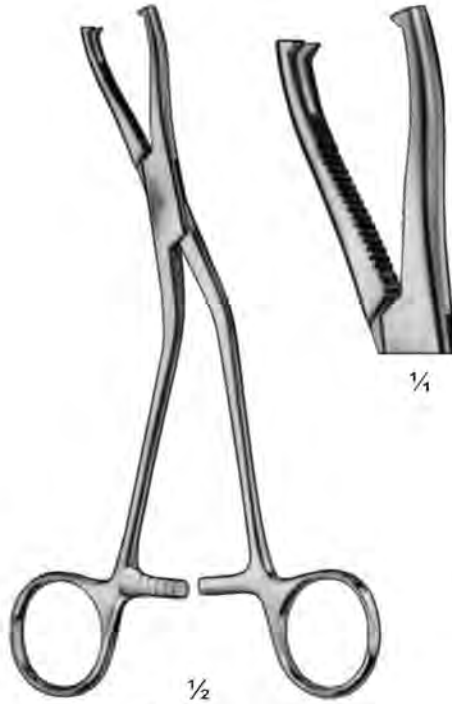

$\frac{1}{2}$   
Dingmann  
505-02-18  
18.5 cm / 7 $\frac{1}{4}$ "



$\frac{1}{2}$   
505-03-16  
16 cm / 6 $\frac{1}{4}$ "



$\frac{1}{2}$   
505-04-19  
19 cm / 7 $\frac{1}{2}$ "

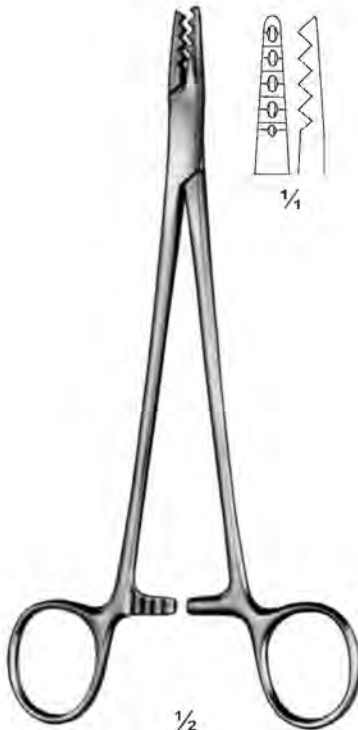

$\frac{1}{2}$   
505-05-19  
19 cm / 7 $\frac{1}{2}$ "



$\frac{1}{2}$   
Perman  
505-06-21  
21 cm / 8 $\frac{1}{4}$ "

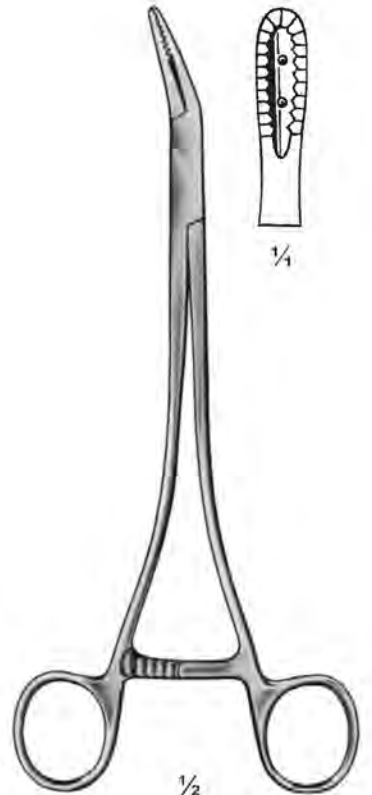

$\frac{1}{2}$   
505-07-21  
21 cm / 8 $\frac{1}{4}$ "

**Sehnenfazzangen  
Bone Holding Forceps  
Pincettes pour saisir les tendons**



Bircher-Granske  
506-01-20  
20 cm / 8"



Bircher-Granske  
506-02-20  
20 cm / 8"



506-03-20 To 506-04-20  
20 cm / 8"

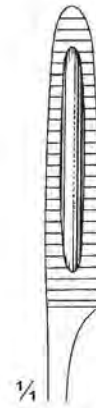

1/4  
506-03-20



1/4  
506-04-20



1/4

1/2

506-05-20  
20 cm / 8"



1/2

506-06-20  
20 cm / 8"

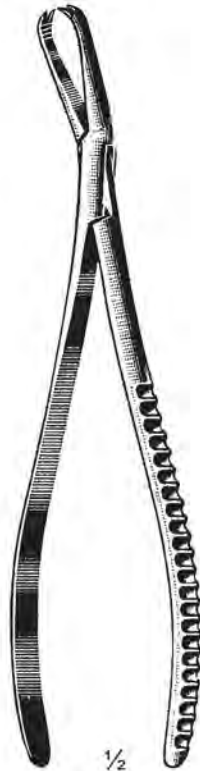

1/2

506-07-20  
20 cm / 8"



1/4



1/2

Van Buren  
506-08-23  
23 cm / 9"

**Sehnenfazzangen  
Bone Holding Forceps  
Pincettes pour saisir les tendons**



Frosch  
507-01-14 Opening 10 mm  
14 cm / 5½"



Frosch  
507-02-18  
18 cm / 7"

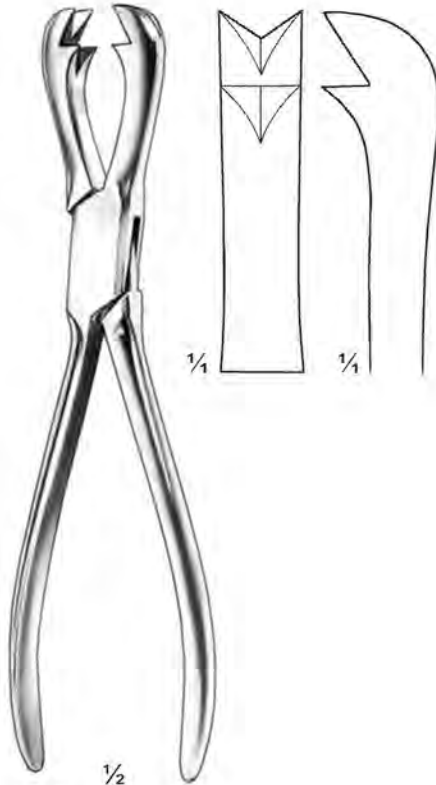

Fergusson  
507-03-21  
21 cm / 8¼"



Rowe-Harrison  
507-04-20  
20 cm / 8"



Semb  
507-05-19  
19 cm / 7½"



¼

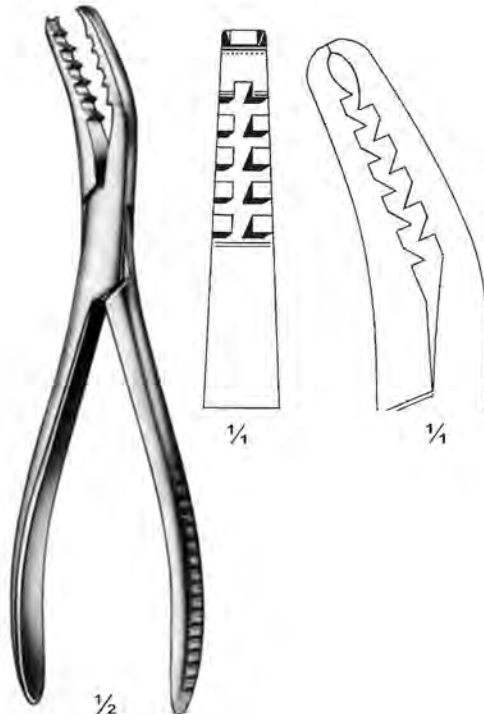

Semb  
507-06-19  
19 cm / 7½"



¼

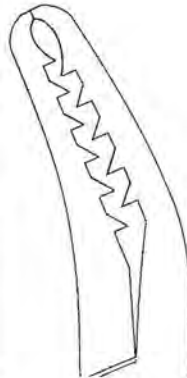

¼

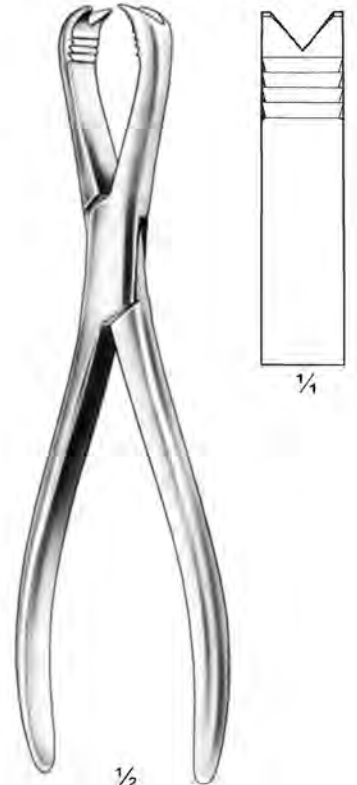

Langenbeck  
507-07-21  
21 cm / 8¼"



¼

**Sehnenfazzangen  
Bone Holding Forceps  
Pincettes pour saisir les tendons**



Kern  
508-01-17 To 508-02-21

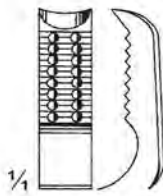

508-01-17  
508-03-17  
17 cm / 6 3/4"

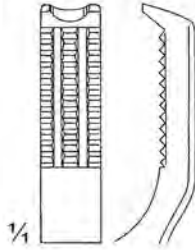

508-02-21  
508-04-21  
21 cm / 8 1/4"

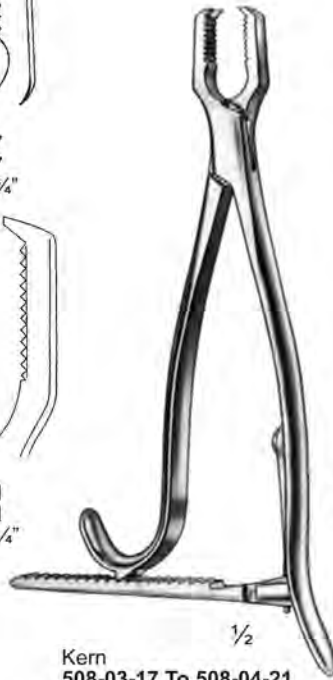

Kern  
508-03-17 To 508-04-21



Kern-Mini  
508-05-14  
14 cm / 5 1/2"



Kern-Mini  
508-06-14  
14 cm / 5 1/2"



Kern-Mini  
508-07-15  
15 cm / 6"



Kern-Lane  
508-08-24  
24 cm / 9 1/2"



Kern-Lane  
508-09-24  
24 cm / 9 1/2"

**Sehnenfazzangen  
Bone Holding Forceps  
Pincés pour saisir les tendons**



1/2

Lane  
509-01-33 To 509-02-45



1/4

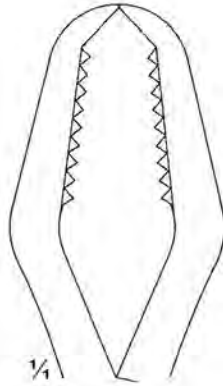

1/4

509-01-33  
509-03-33  
33 cm / 13"

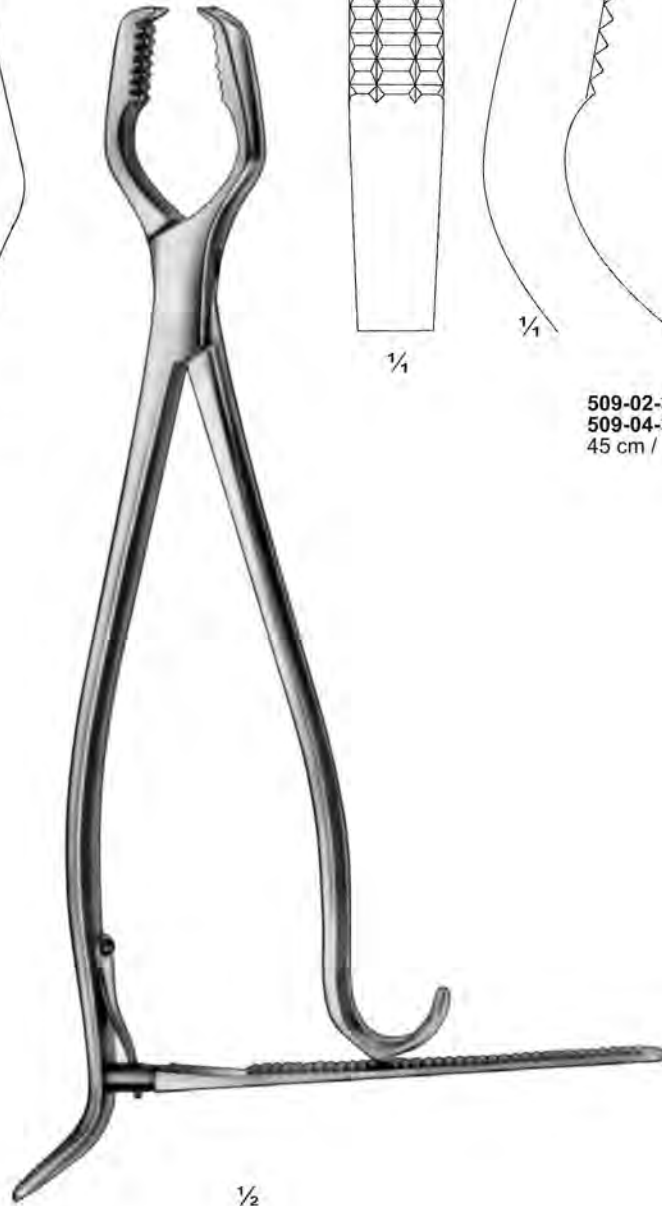

1/2

Lane  
509-03-33 To 509-04-45

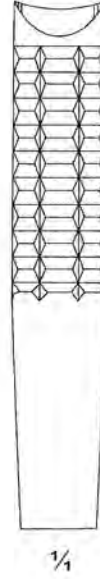

1/4

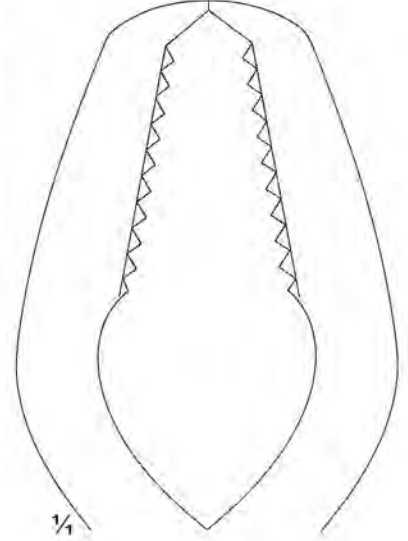

1/4

509-02-33  
509-04-33  
45 cm / 17 3/4"

**Sehnenfazzangen  
Bone Holding Forceps  
Pincés pour saisis les tendons**



Farabeuf  
510-01-23 To 510-02-26

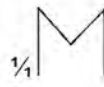
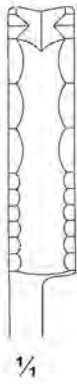

510-01-23  
23 cm / 9"  
9 mm

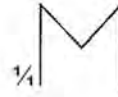

510-02-26  
26 cm / 10 1/4"  
11 mm



Tuffier  
510-03-27  
27 cm / 10 1/2"

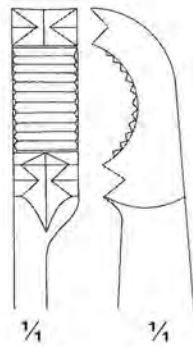

Farabeuf-Lambotte  
510-04-26  
26 cm / 10 1/4"

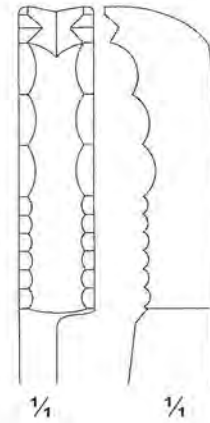

Farabeuf-Lambotte  
510-05-15  
15 cm / 6"

**Sehnenfasszangen  
Bone Holding Forceps  
Pincettes pour saisir les tendons**



1/2

Lambotte  
511-01-22 22 cm / 8 3/4"  
511-02-27 27 cm / 10 1/2"  
511-03-30 30 cm / 12"

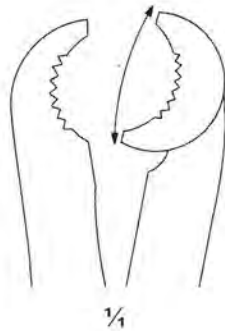

1/4



1/2

Lambotte  
511-04-22 To 511-06-33



1/2

511-04-22  
22 cm / 8 3/4"



1/2

511-05-26  
26 cm / 10 1/4"



1/2

511-06-33  
33 cm / 13"



1/2

511-07-21 To 511-08-27



1/2

511-07-21  
21.5 cm / 8 1/2"



1/2

511-08-27  
27.5 cm / 10 3/4"



**Sehnenfazzangen**  
**Bone Holding Forceps**  
**Pinces pour saisir les tendons**



512-01-23  
 512-04-23  
 23 cm / 9"



512-02-25  
 512-05-25  
 25 cm / 10"



512-03-28  
 512-06-28  
 28 cm / 11"



Verbrugge  
 512-07-17  
 17 cm / 6 3/4"



Ulrich  
 512-01-23 To 512-03-28



Ulrich  
 512-04-23 To 512-06-28

**Sehnenfazzangen**  
**Bone Holding Forceps**  
**Pinces pour saisir les tendons**

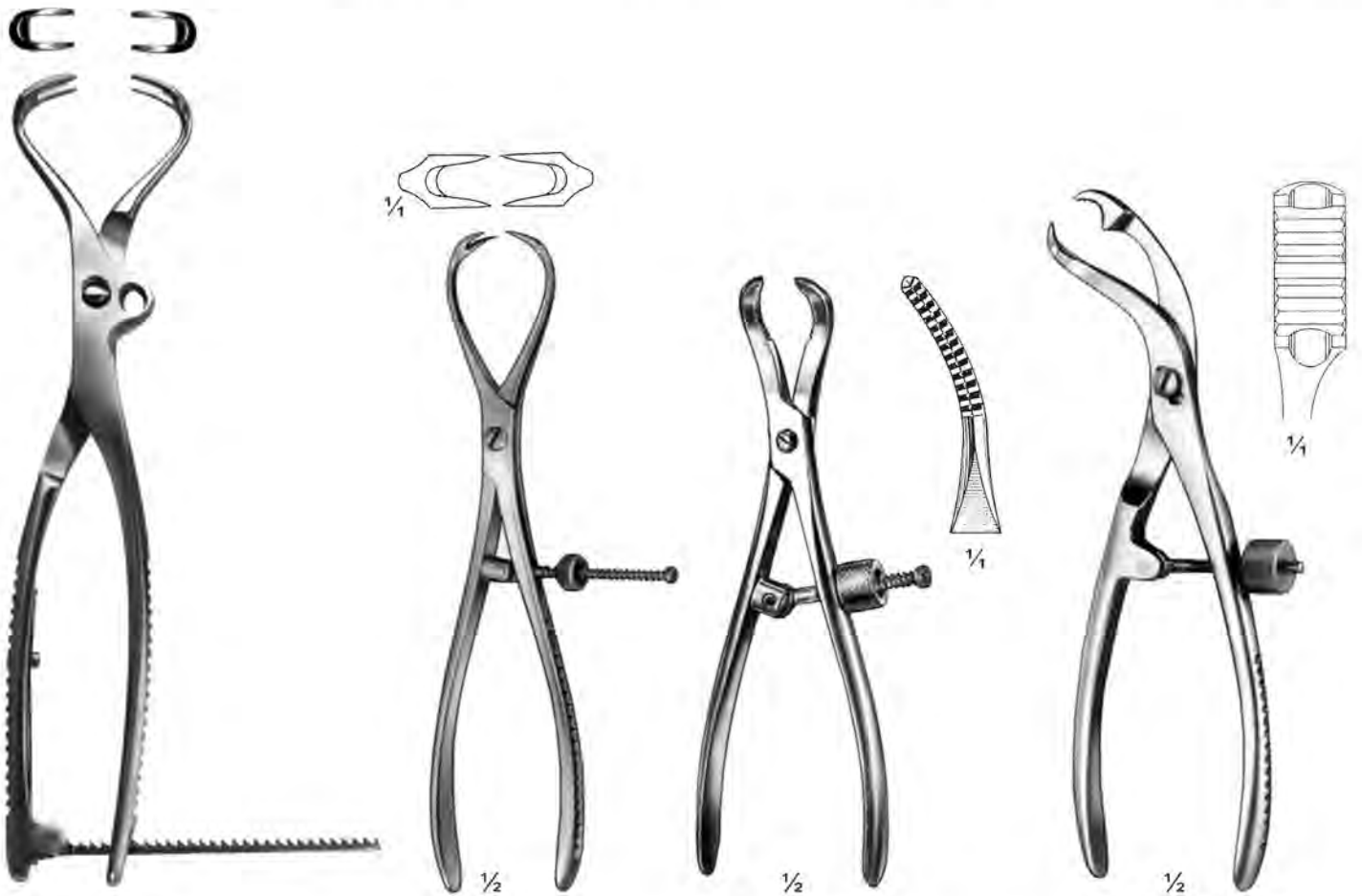
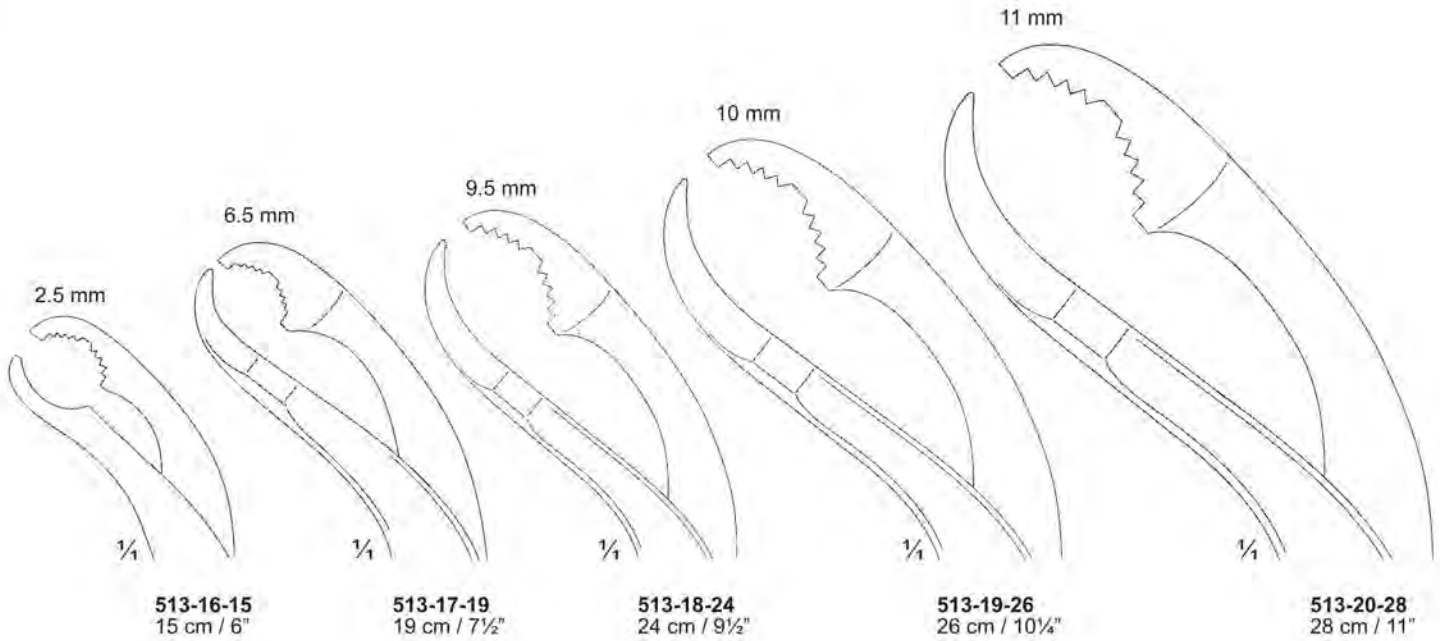

**513-01-16** 16 cm / 6¼"  
**513-02-18** 18 cm / 7"  
**513-03-20** 20 cm / 8"  
**513-04-22** 22 cm / 8¾"  
**513-05-24** 24 cm / 9½"

**513-06-16** 16 cm / 6¼"  
**513-07-18** 18 cm / 7"  
**513-08-20** 20 cm / 8"  
**513-09-22** 22 cm / 8¾"  
**513-10-24** 24 cm / 9½"

**513-11-16** 16 cm / 6¼"  
**513-12-18** 18 cm / 7"  
**513-13-20** 20 cm / 8"  
**513-14-22** 22 cm / 8¾"  
**513-15-24** 24 cm / 9½"

**513-16-15 To 513-20-28**  
 Self-Centering

**Sehnenfazzangen  
Bone Holding Forceps  
Pincettes pour saisir les tendons**

6.5 mm



**514-01-21**  
21 cm / 8¼"

7.5 mm



**514-02-27**  
27 cm / 10½"

8.5 mm



**514-03-30**  
30 cm / 12"



Hey-Groves  
**514-01-21 To 514-03-30**  
Both blades serrated



**514-04-16** 16 cm / 6¼"  
**514-05-19** 19 cm / 7½"  
**514-06-23** 23 cm / 9"  
**514-07-25** 25 cm / 10"



**514-08-16** 16 cm / 6¼"  
**514-09-19** 19 cm / 7½"  
**514-10-23** 23 cm / 9"  
**514-11-25** 25 cm / 10"

**Sehnenfazzangen  
Bone Holding Forceps  
Pinces pour saisir les tendons**

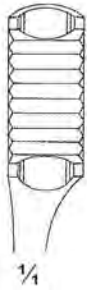

Verbrugge  
515-01-25 To 515-03-27

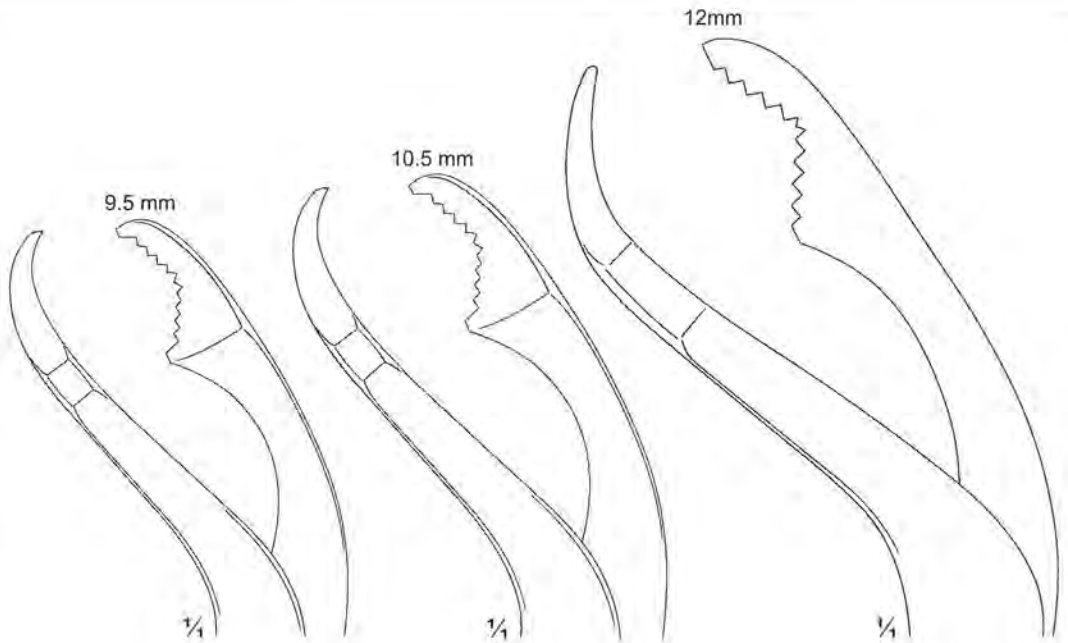

515-01-25  
25 cm / 10"

515-02-26  
26 cm / 10 1/4"

515-03-27  
27 cm / 11"

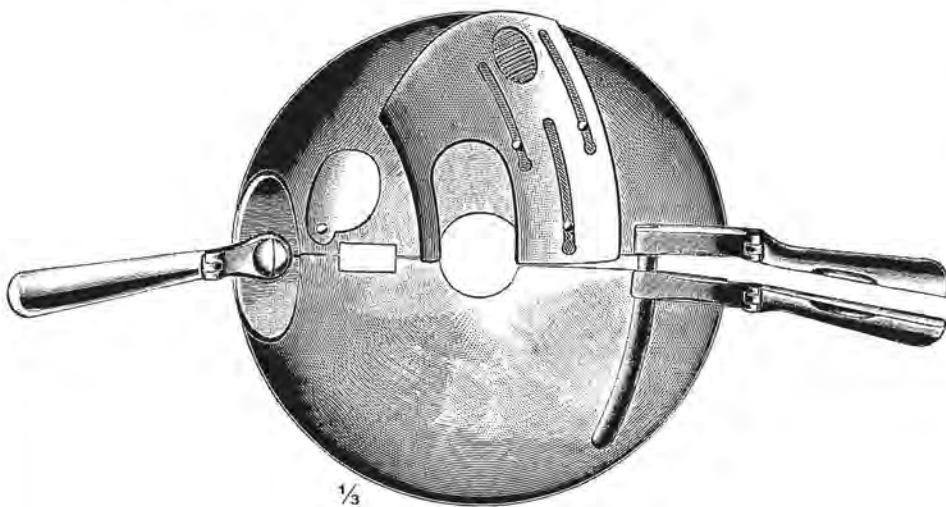

Percy  
515-04-19  
19.5 cm / 7 3/4"  
Reversible handles



Percy  
515-05-16  
16.5 cm / 6 1/2"

**Knochenhalteklammern  
Bone Holding Forceps  
Daviers à os**



Lowmann  
516-01-18 To 516-03-22

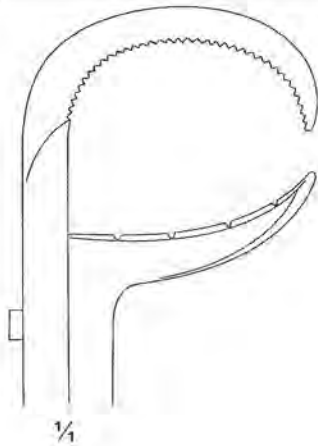

1/4

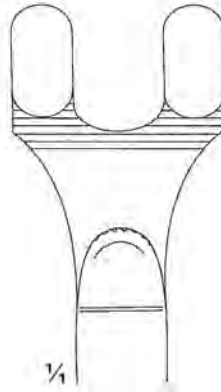

1/4

516-01-18  
516-04-18  
18 cm / 7"

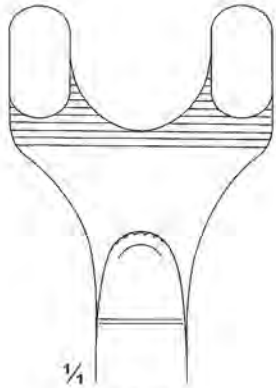

1/4

516-02-20  
516-05-20  
20 cm / 8"

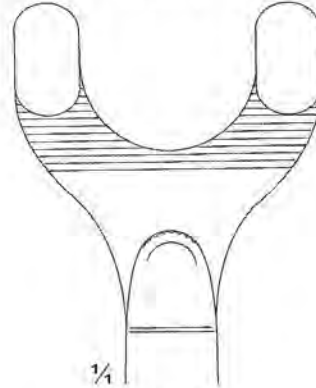

1/4

516-03-22  
516-06-22  
22 cm / 8 3/4"



Lowmann  
516-04-18 To 516-06-22



Lowmann  
516-07-12 12 cm / 4 3/4"  
516-08-15 15 cm / 6"  
516-09-18 18 cm / 7"  
516-10-20 20 cm / 8"  
516-11-22 22 cm / 8 3/4"

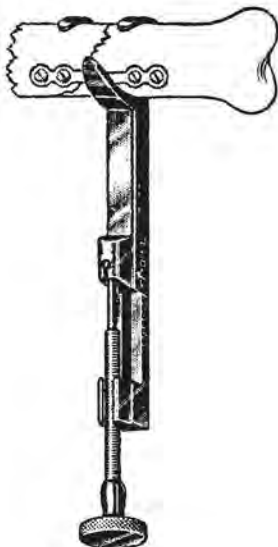

Lowmann  
516-12-12 12 cm / 4 3/4"  
516-13-15 15 cm / 6"

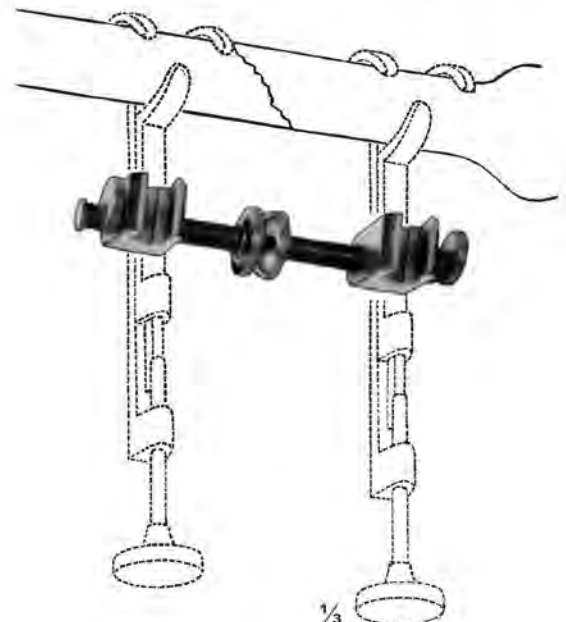

Gerster  
516-14-00  
Traction bar for Lowmann clamps

**Knochenhalteklammern  
Bone Holding Forceps  
Daviers à os**



½  
Lowmann-Hoglund  
517-01-12 12 cm / 4¾"  
517-02-15 15 cm / 6"  
517-03-18 18 cm / 7"  
517-04-20 20 cm / 8"  
517-05-22 22 cm / 8¾"

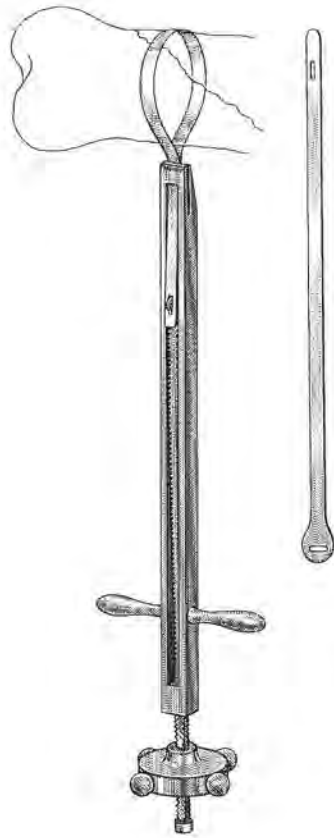

Parham  
517-06-21  
21.5 cm / 8½"  
With 2 bands



½  
Lowmann-Gerster  
517-07-12 12 cm / 4¾"  
517-08-15 15 cm / 6"  
517-09-18 18 cm / 7"  
517-10-20 20 cm / 8"  
517-11-22 22 cm / 8¾"



Lambert-Lowmann  
517-12-12 12 cm / 4¾"  
517-13-15 15 cm / 6"  
517-14-18 18 cm / 7"  
517-15-20 20 cm / 8"  
517-16-22 22 cm / 8¾"

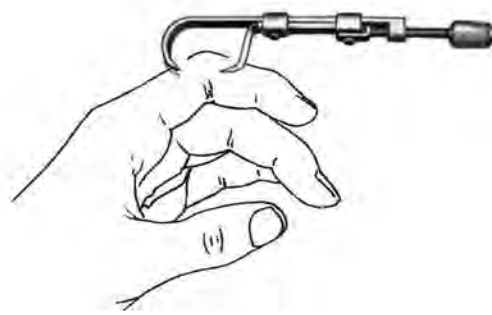

½  
Bunnell-Howard  
517-17-15  
15 cm / 6"



**Bleihände, Fingernagelbohrer, Fingerringsägen**  
**Lead Hand, Finger Nail Drill, Finger Ring Saws**  
**Manches en plomb, perforateur à ongles, scies pour couper les bagues**



1/2

**518-01-01** Child size  
**518-02-02** Adult size



1/2

Feldheim  
**518-03-10**  
 10 cm / 4"

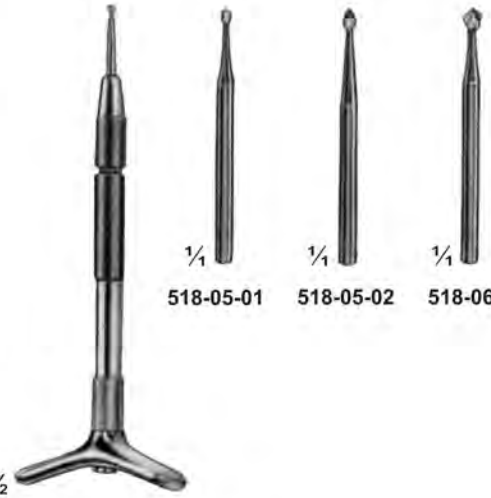

1/4

**518-05-01**

1/4

**518-05-02**

1/4

**518-06-03**

1/2

**518-04-01 To 518-06-03**  
 With 1 drill point  
**518-07-03**  
 With 3 drill points



1/4

**518-08-01**

1/4

**518-09-02**

1/4

**518-10-03**

**518-08-01 To 518-10-03**  
 With 1 drill point  
**518-11-03**  
 With 3 drill points



1/2

Systrunk  
**518-12-13**  
 13 cm / 5 1/8"



1/2

**518-13-13**  
 13.5 cm / 5 1/4"  
 Nail splitting forceps



1/4

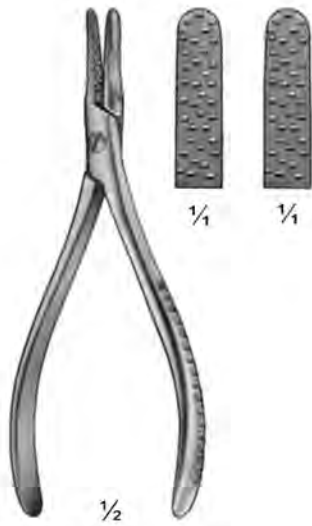

519-01-13  
13.5 cm / 5 1/4"



519-02-14  
14.5 cm / 5 3/4"

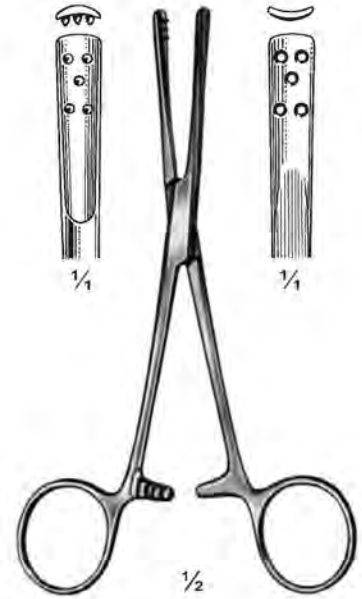

Penner  
519-03-15  
15.5 cm / 6 1/8"



519-04-17  
17 cm / 6 3/4"



Walton  
519-05-16  
16 cm / 6 1/4"

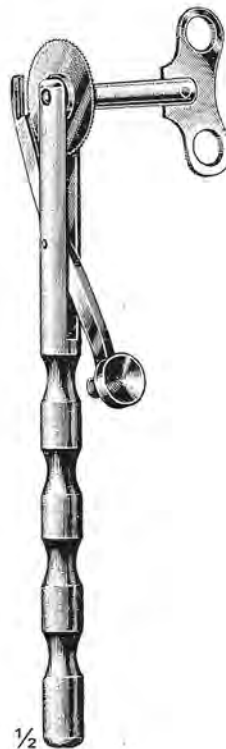

Smith  
519-06-19  
19 cm / 7 1/2"



519-07-17  
17 cm / 6 3/4"





Rippenscheren  
Rib Shears  
Costotomes



$\frac{1}{2}$   
520-01-23  
23 cm / 9"



$\frac{1}{2}$   
520-02-22  
22 cm / 8 $\frac{3}{4}$ "



$\frac{1}{2}$   
Gluck  
520-03-16 16 cm / 6 $\frac{1}{4}$ "  
520-04-18 18 cm / 7"  
520-05-20 20 cm / 8"  
520-06-23 23 cm / 9"



$\frac{1}{2}$   
Stille  
520-07-21  
21 cm / 8 $\frac{1}{4}$ "

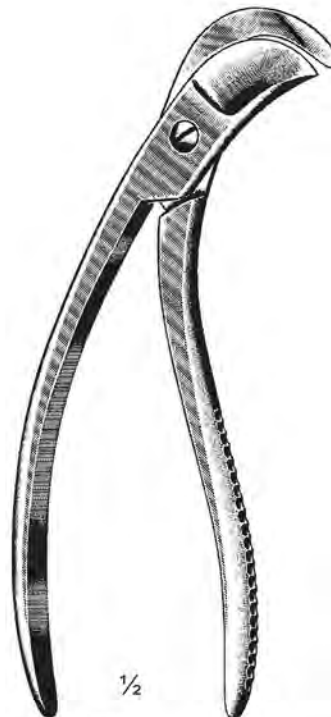

$\frac{1}{2}$   
Collin  
520-08-19  
19.5 cm / 7 $\frac{3}{4}$ "



$\frac{1}{2}$   
Collin  
520-09-17  
17 cm / 6 $\frac{3}{4}$ "



1/3

Sauerbruch  
521-01-23 23 cm / 9"  
521-02-26 26 cm / 10 1/4"



1/3

Lebsche  
521-03-25  
25 cm / 10"



1/3

Giertz-Stille  
521-04-25  
25 cm / 10"



1/3

Sauerbruch-Frey  
521-05-36  
36 cm / 14"



1/3

Brunner  
521-06-34  
34 cm / 13 1/2"



1/2

Schuchardt  
521-07-17 17 cm / 6 3/4"  
521-08-23 23 cm / 9"

Rippenscheren  
Rib Shears  
Costotomes



Baer  
522-01-19 & 522-02-23

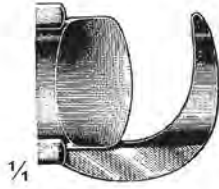

522-01-19  
19 cm / 7½"

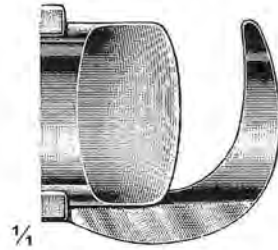

522-02-23  
23 cm / 9"



1/3  
Sauerbruch-Britsch  
522-03-30  
30 cm / 12"  
With 2 exchangeable  
cutterheads

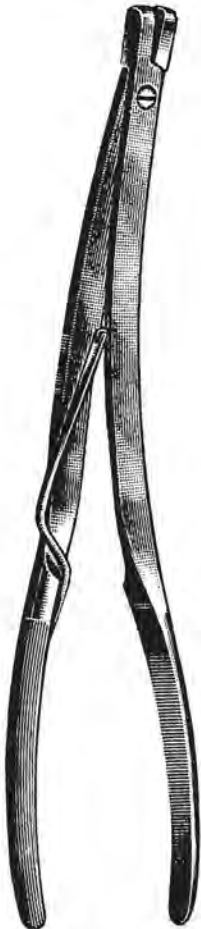

Lebsche  
522-04-33  
33 cm / 13"



522-06-30  
Right

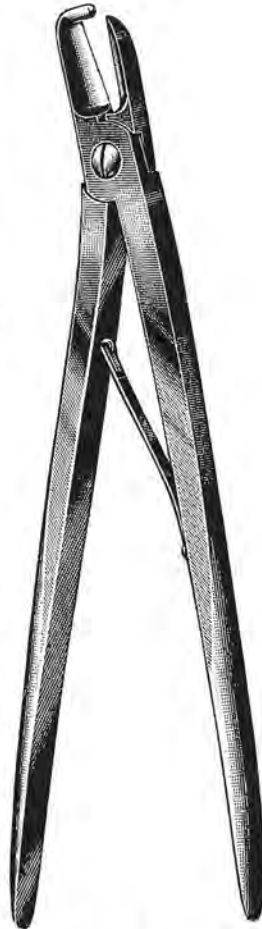

522-05-30 Left  
Coryllos-Bethune (Collin)  
522-05-30 & 522-06-30  
30 cm / 12"

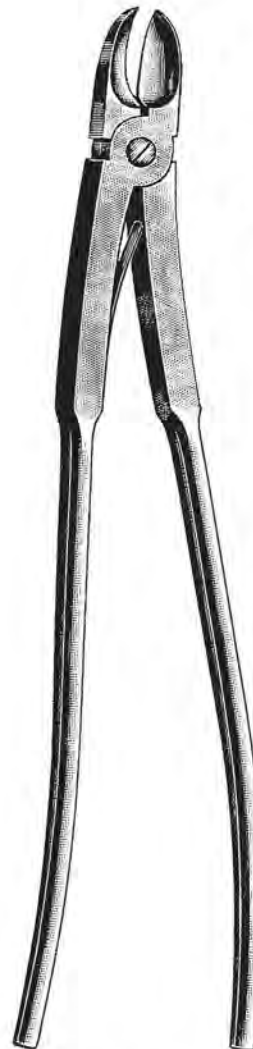

Bethune  
522-07-34  
34 cm / 13½"

Rippenscheren  
Rib Shears  
Costotomes



Potts  
523-01-15  
15 cm / 6"  
One Blade serrated



Braun-Stadler  
523-02-20  
20 cm / 8"  
One blade serrated



Lebsche  
523-03-20  
20 cm / 8"



Schumacher  
523-04-21  
21 cm / 8¼"

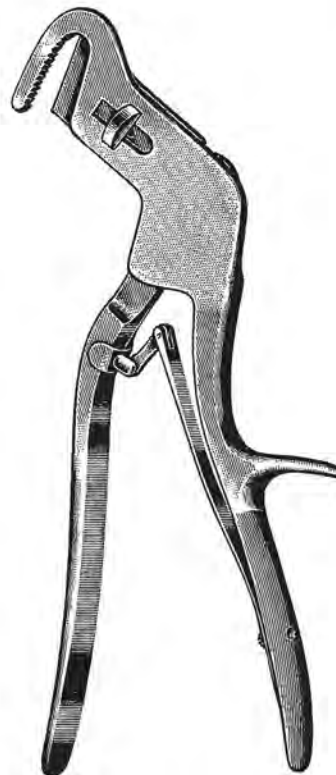

Lebsche  
523-05-25  
25 cm / 10"



Oelert  
523-06-28  
28 cm / 11"

Rippensperrer  
Rib Spreaders  
Ecarteurs des côtes



**524-01-12**  
Opening 12 cm / 4 3/4"  
Blades 28 X 32 mm



Morse  
**524-02 -20** For children  
With moveable double blades  
Opening 20 cm / 8"  
Blades 12 X 20 mm  
**524-03-20** For adults  
With moveable double blades  
Opening 20 cm / 8"  
Blades 19 X 19 mm

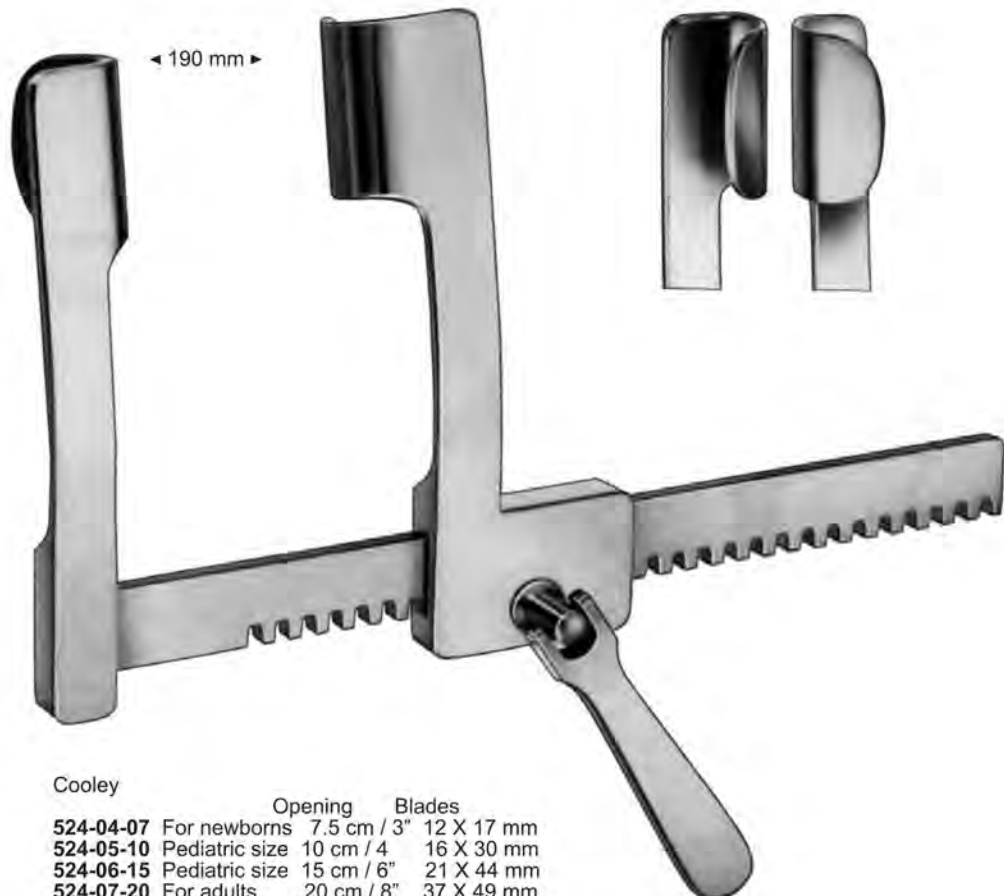

Cooley

		Opening	Blades
<b>524-04-07</b>	For newborns	7.5 cm / 3"	12 X 17 mm
<b>524-05-10</b>	Pediatric size	10 cm / 4"	16 X 30 mm
<b>524-06-15</b>	Pediatric size	15 cm / 6"	21 X 44 mm
<b>524-07-20</b>	For adults	20 cm / 8"	37 X 49 mm



Struck  
525-01-07 To 525-05-07  
Opening 7.5 cm / 3"  
For infants



525-01-07  
Blades 10 X 10 mm

525-02-07  
Blades 10 X 15 mm

525-03-07  
Blades 10 X 20 mm



525-04-07  
Blades 15 X 20 mm

525-05-07  
Blades 20 X 20 mm

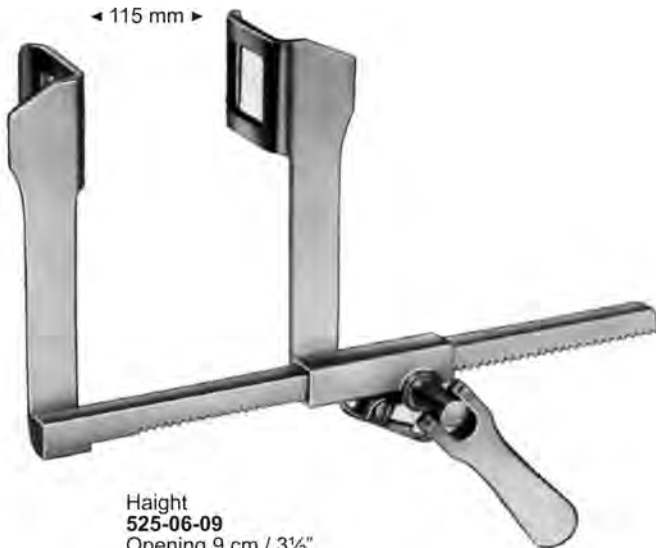

Haight  
525-06-09  
Opening 9 cm / 3½"  
Blades 30 X 30 mm  
525-07-11  
Opening 11.5 cm / 4½"  
Blades 30 X 30 mm

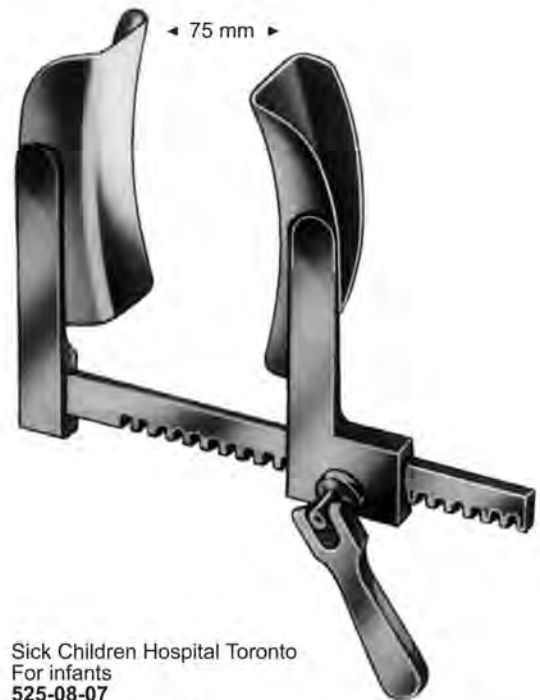

Sick Children Hospital Toronto  
For infants  
525-08-07  
Opening 7.5 cm / 3"  
Blades 20 X 40 mm  
525-09-07  
Opening 7.5 cm / 3"  
Blades 20 X 60 mm

**Rippensperrer  
Rib Spreaders  
Ecarteurs des côtes**



**Tuffier**  
**526-01-13** Opening 13 cm / 5 1/8"  
**526-02-15** Opening 15 cm / 6"  
**526-03-16** Opening 16.5 cm / 6 1/2"  
 Blades 50 X 45 mm

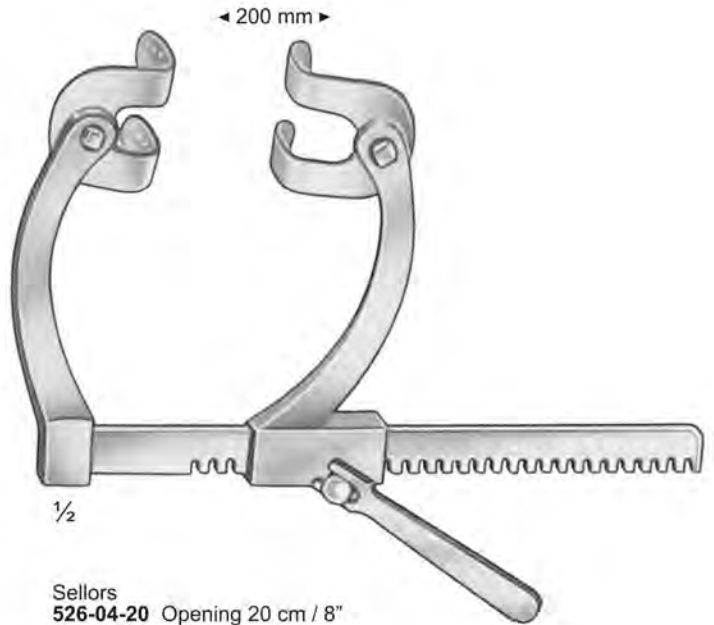

**Sellors**  
**526-04-20** Opening 20 cm / 8"  
 Blades 38 X 50 mm



**Finochietto**

Opening	Blades
<b>526-05-14</b> 14 cm / 5 1/2"	36 X 45 mm
<b>526-06-16</b> 16.5 cm / 6 1/2"	40 X 40 mm
<b>526-07-21</b> 21 cm / 8 1/4"	44 X 65 mm
<b>526-08-21</b> 21 cm / 8 1/4"	65 X 65 mm
<b>526-09-25</b> 25 cm / 10"	70 X 65 mm
<b>526-10-30</b> 30 cm / 12"	70 X 65 mm



**Finochietto**  
**526-11-07**  
 Opening 7.5 cm / 3"  
 Blades 18 X 21 mm

**Rippensperrer  
Rib Spreaders  
Ecarteurs des côtes**

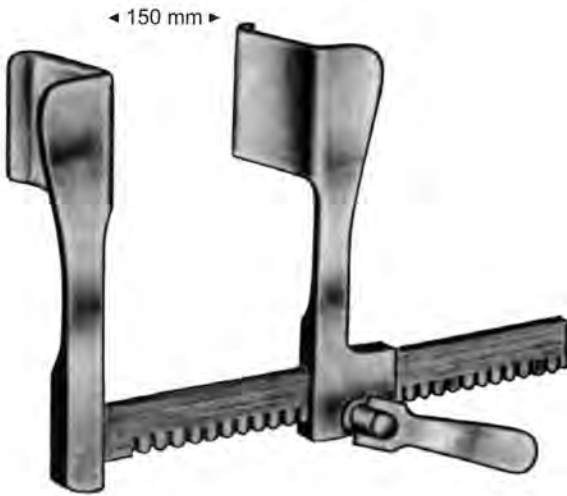

Reinhoff-Finochietto  
Opening  
527-01-15 15 cm / 6"    Blades 25 X 20 mm  
527-02-15 15 cm / 6"    38 X 32 mm  
527-03-15 15 cm / 6"    48 X 45 mm



Hertzler  
Opening  
527-04-07 7.5 cm / 3"    Blades 25 X 20 mm  
527-05-09 9.5 cm / 3¾"    38 X 32 mm  
527-06-10 10.5 cm / 4"    48 X 45 mm



De Bakey  
527-07-15 To 527-09-15  
Opening 15 cm / 6"  
527-10-03  
With 3 pairs of interchangeable  
blades 527-07-15 To 527-09-15



527-07-15  
Blades 30 X 30 mm



527-08-15  
Blades 40 X 40 mm



527-09-15  
Blades 50 X 50 mm



**Rippensperrer  
Rib Spreaders  
Ecarteurs des côtes**



Nissen  
**528-01-23** Opening 23 cm / 9"  
 Blades 25 X 75 mm  
 Blades 40 X 53 mm  
**528-02-25** Opening 25 cm / 10"  
 Blades 25 X 75 mm  
 Blades 40 X 53 mm



**528-04-20**  
Blades 80 X 60 mm



**528-05-20**  
Blades 60 X 60 mm

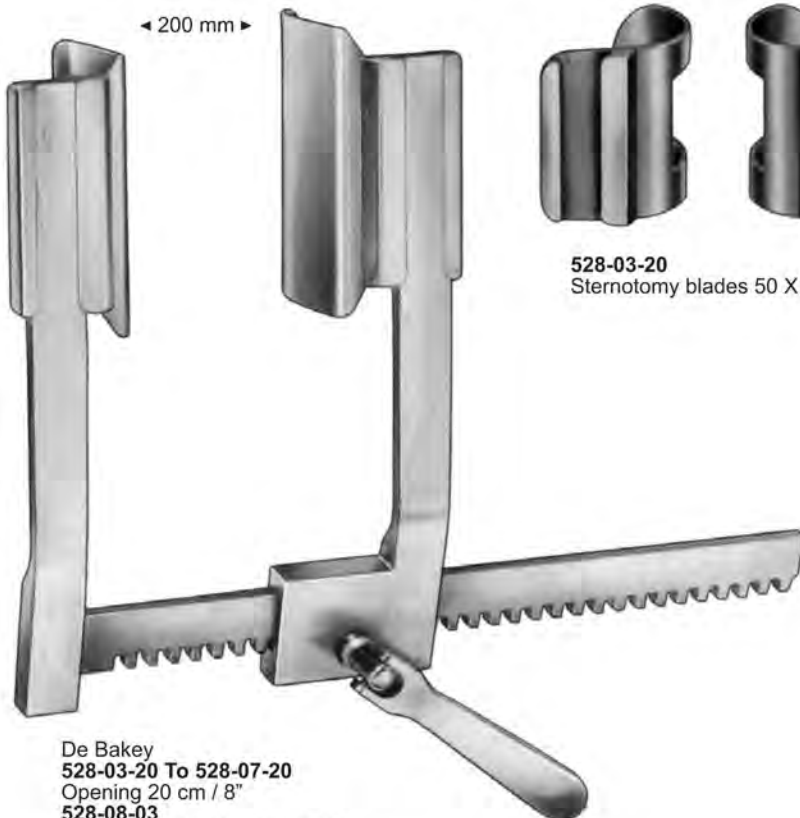

De Bakey  
**528-03-20 To 528-07-20**  
 Opening 20 cm / 8"  
**528-08-03**  
 With 3 pairs of interchangeable  
 blades 528-05-20 To 528-07-20



**528-03-20**  
Sternotomy blades 50 X 66 mm



**528-06-20**  
Blades 50 X 80 mm



**528-07-20**  
Blades 40 X 100 mm

**Rippensperrer  
Rib Spreaders  
Ecarteurs des côtes**

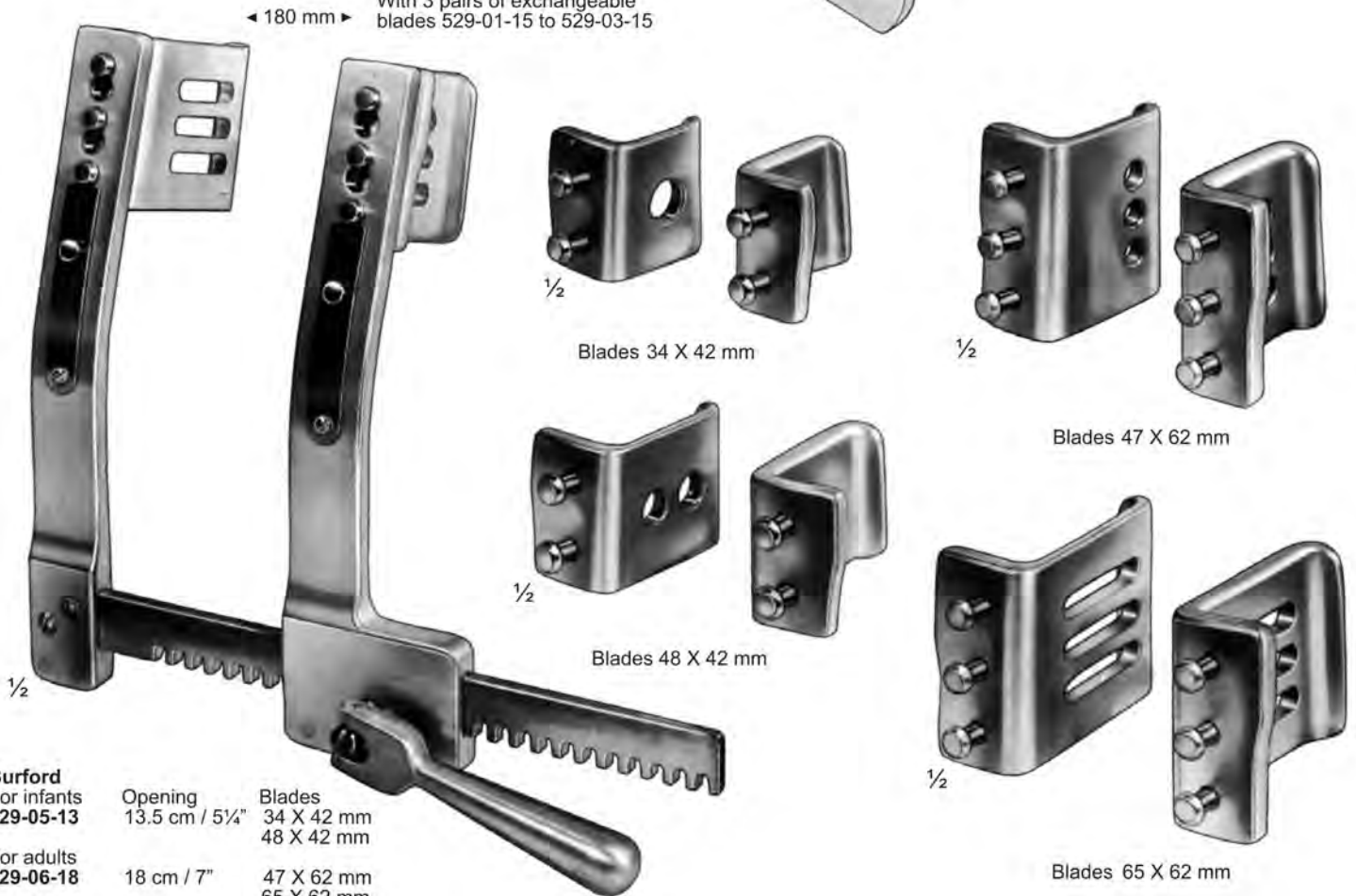
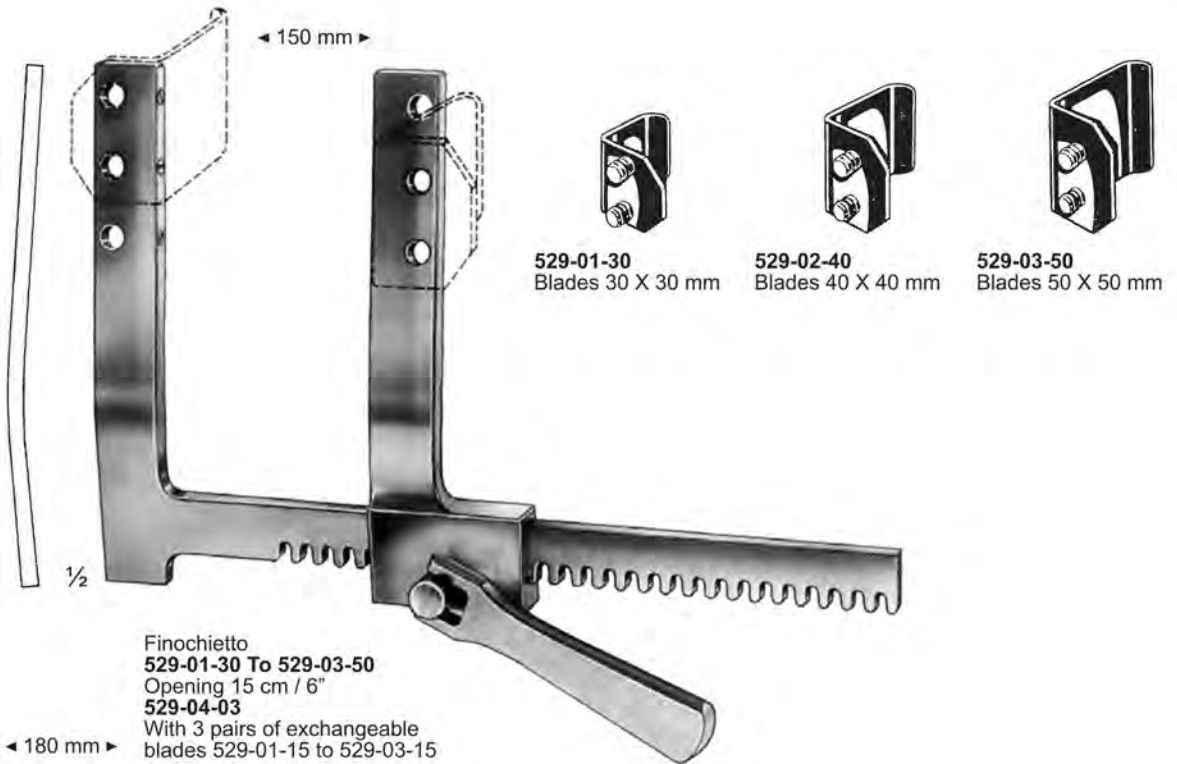

Burford	Opening	Blades
For infants <b>529-05-13</b>	13.5 cm / 5 1/4"	34 X 42 mm 48 X 42 mm
For adults <b>529-06-18</b>	18 cm / 7"	47 X 62 mm 65 X 62 mm
<b>529-07-26</b>	26 cm / 10 1/4"	47 X 62 mm 65 X 62 mm
<b>529-08-30</b>	30 cm / 12"	47 X 62 mm 65 X 62 mm

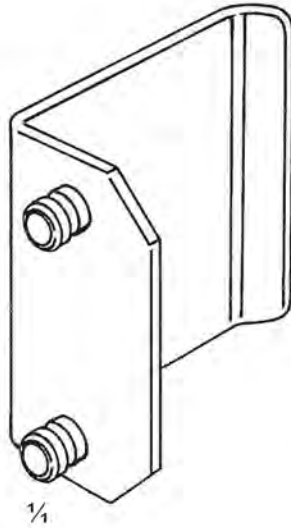
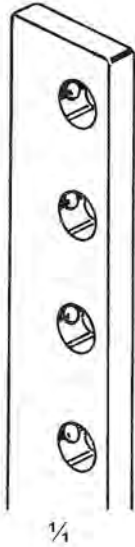

**530-01-25**  
Blades 60 X 60 mm



**530-02-25**  
Blades 50 X 80 mm



**530-03-25**  
Blades 40 X 100 mm

Complementary Exchangeable Blades



**530-04-25**  
Blades 70 X 55 mm



**530-05-25**  
Blades 80 X 60 mm



**530-06-25**  
Blades 80 X 100 mm

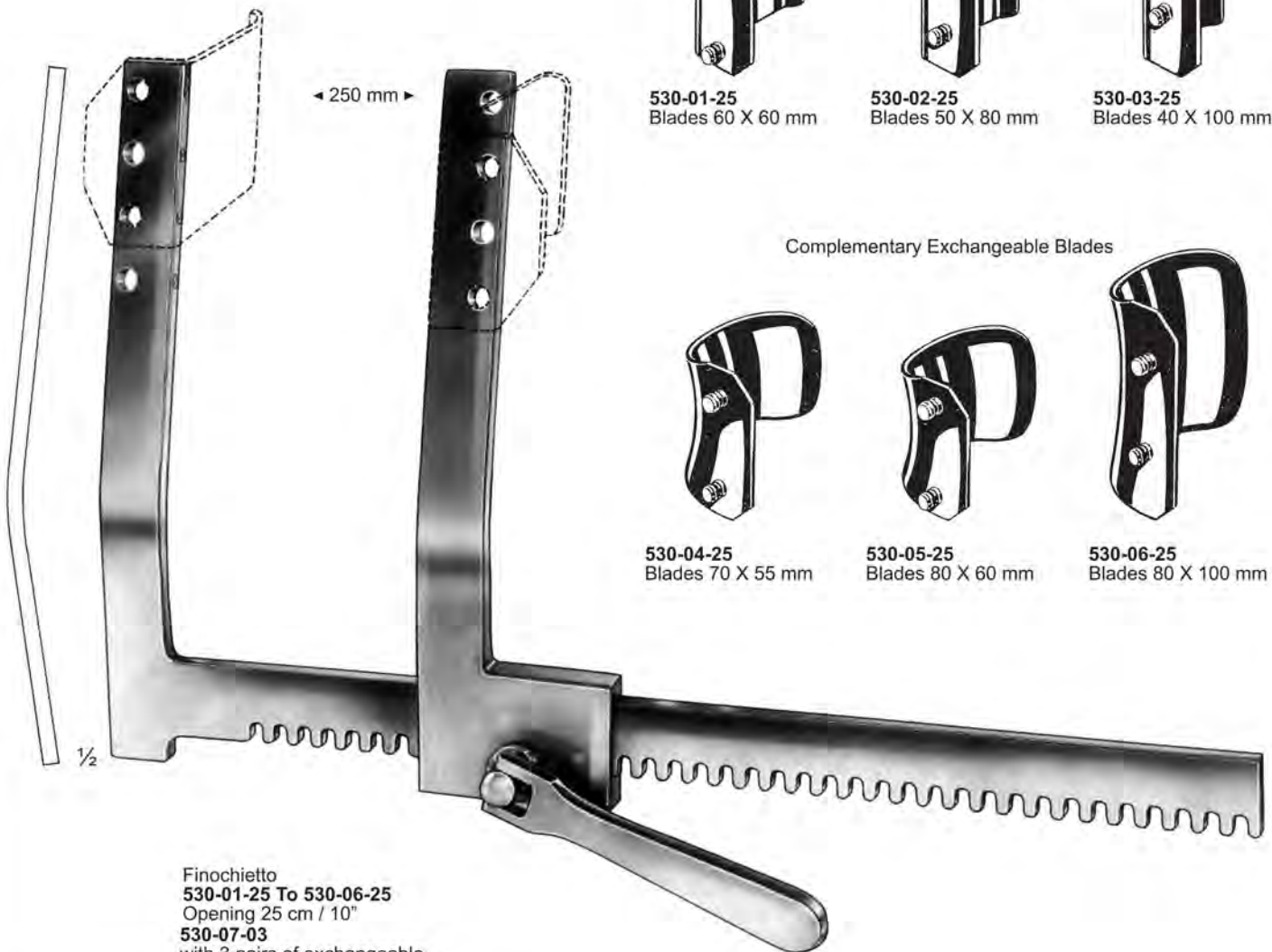

**Finochietto**  
**530-01-25 To 530-06-25**  
Opening 25 cm / 10"  
**530-07-03**  
with 3 pairs of exchangeable  
blades 530-01-25 To 530-03-25



**Cooley**

		Opening	Blades
531-01-07	For newborns	7.5 cm / 3"	12 X 17 mm
531-02-10	Pediatric size	10 cm / 4"	16 X 30 mm
531-03-15	Pediatric size	15 cm / 6"	21 X 44 mm
531-04-20	For adults	20 cm / 8"	37 X 49 mm

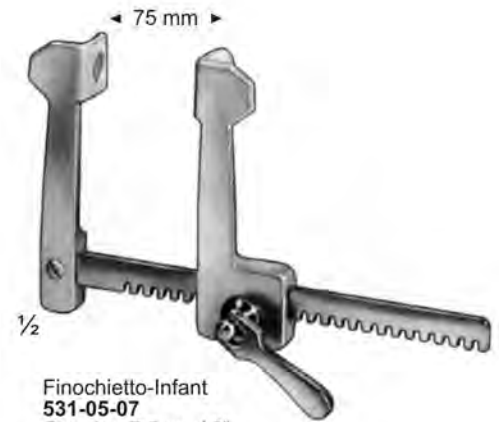

**Finochietto-Infant**  
531-05-07  
Opening 7.5 cm / 3"  
Blades 15 X 15 mm  
For infants



**Finochietto-Baby-Haight**  
531-06-10  
Opening 10 cm / 4"  
Blades 31 X 31 mm  
For children

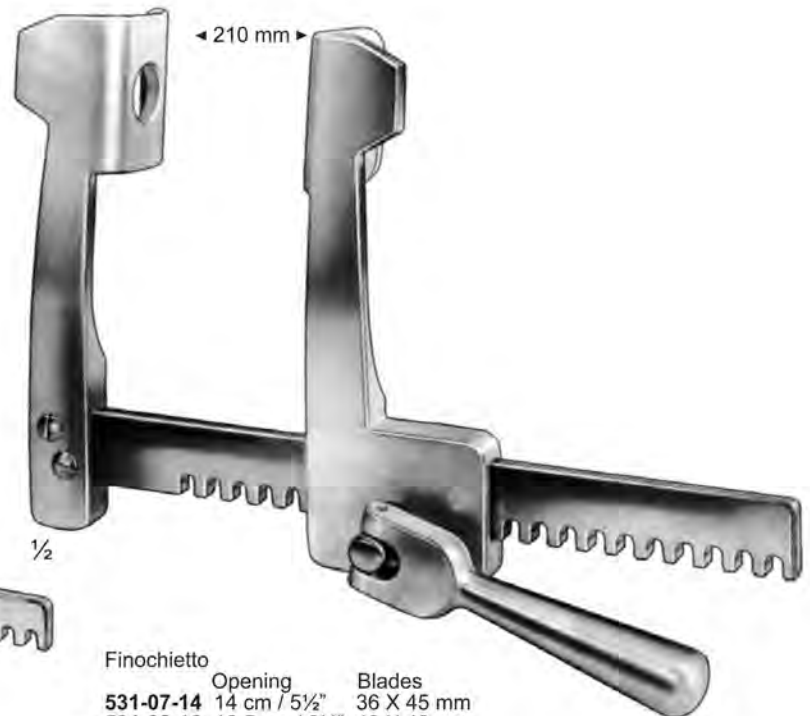

**Finochietto**

	Opening	Blades
531-07-14	14 cm / 5½"	36 X 45 mm
531-08-16	16.5 cm / 6½"	40 X 40 mm
531-09-21	21 cm / 8¼"	44 X 65 mm
531-10-21	21 cm / 8¼"	65 X 65 mm
531-11-25	25 cm / 10"	70 X 65 mm
531-12-30	30 cm / 12"	70 X 65 mm

**Rippensperrer  
Rib Spreaders  
Ecarteurs des côtes**

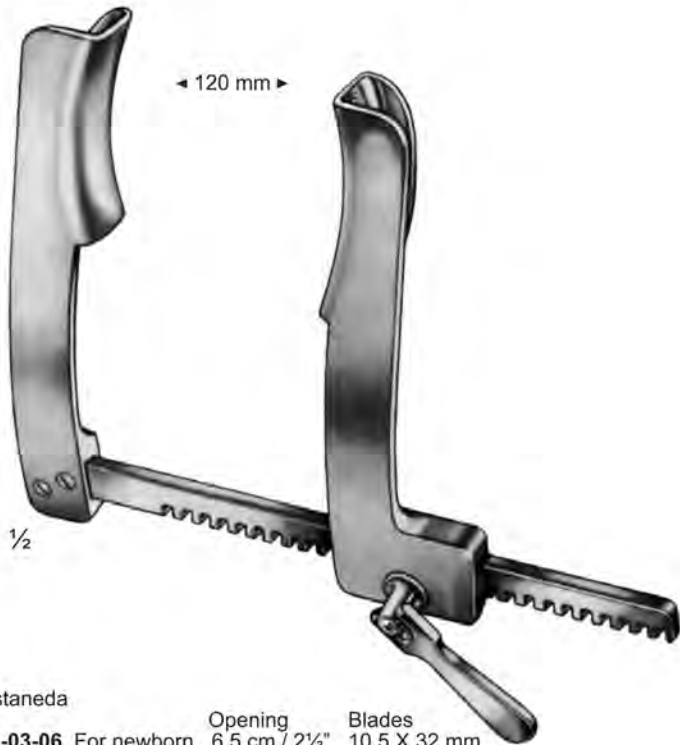
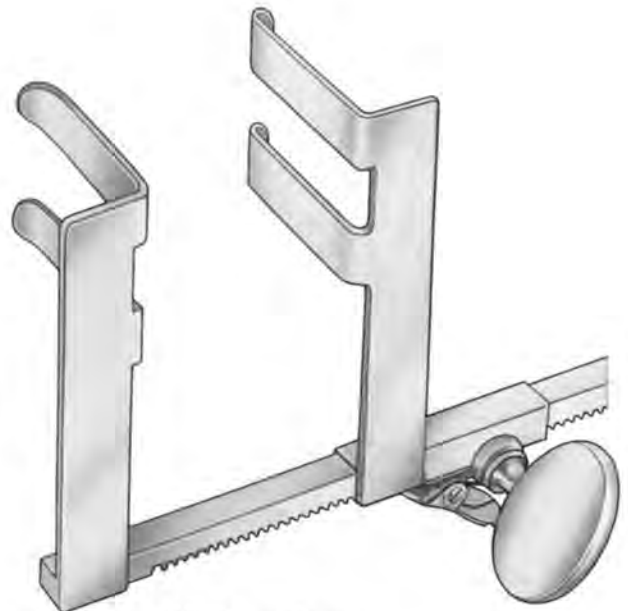
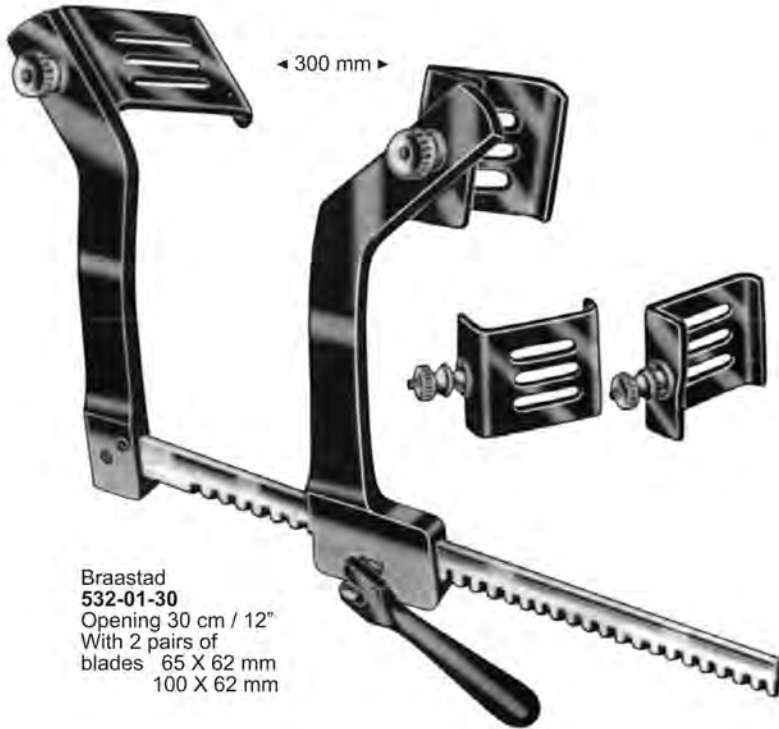

Rippensperrer  
Rib Spreaders  
Ecarteurs des côtes

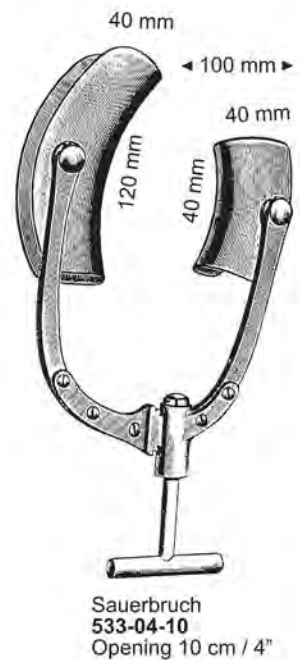
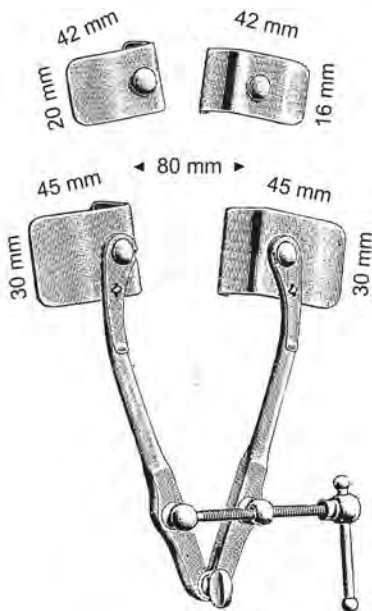



**534-01-24**  
Thoracic retractor (Mercedes-Retractor)  
Complete consisting :  
1 Retractor Opening 24 cm / 9½"  
1 Pair of blades 42 X 65 mm  
1 Pair of blades 75 X 75 mm

Rippensperrer  
Rib Spreaders  
Ecarteurs des côtes



535-01-17  
17 cm / 6 3/4"



Lemmon  
535-02-14 14.5 cm / 5 3/4"  
535-03-18 18 cm / 7"



Bailey-Baby  
535-04-14  
14 cm / 5 1/2"

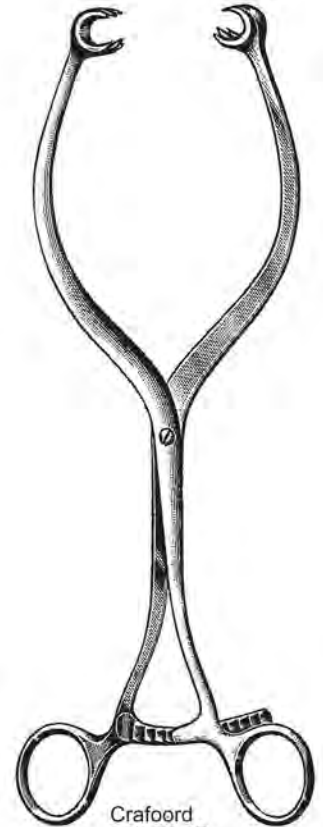

Crafoord  
535-09-28  
28 cm / 11"

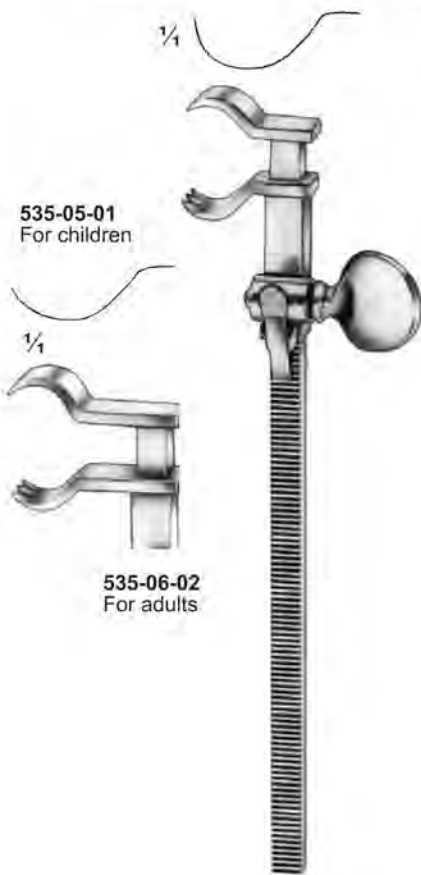

535-05-01  
For children

535-06-02  
For adults



Sellers  
535-07-20  
20 cm / 8"

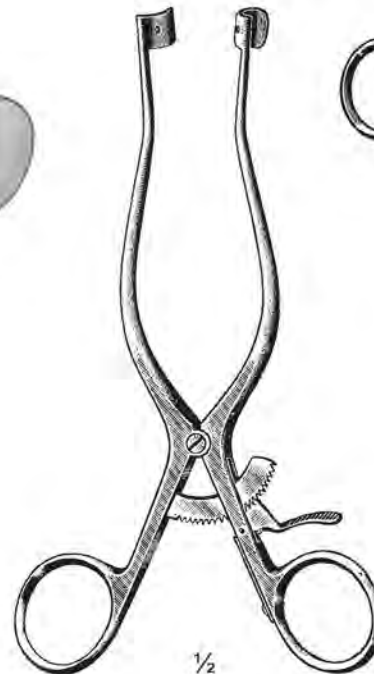

Rehbein (Mod. Bremen)  
535-08-17  
17 cm / 6 3/4"

Bailey  
535-05-01 To 535-06-02  
20 cm / 8"



**Bronchusklemmen  
Bronchus Clamps  
Pince-clamps à bronches**



$\frac{1}{4}$   
536-01-23



$\frac{1}{4}$   
536-02-23



$\frac{1}{4}$   
536-04-23



$\frac{1}{4}$



Price Thomas  
536-05-23  
23 cm / 9"



Semb  
536-06-24 & 536-07-24  
24 cm / 9½"



Price Thomas  
536-08-23 & 536-09-23  
23 cm / 9"



$\frac{1}{4}$

536-08-23



536-09-23



**Lungenfasszangen  
Lung Grasping Forceps  
Pince-clamps au poumon**



$\frac{1}{2}$   
537-01-60 & 537-02-80  
23 cm / 9"



$\frac{1}{4}$   
537-01-60  
60 mm



$\frac{1}{4}$   
537-02-80  
80 mm

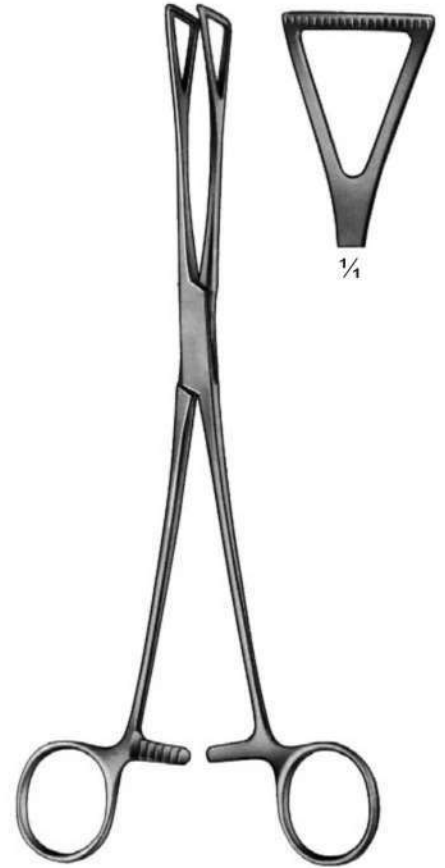

Duval  
537-03-23  
23 cm / 9"



$\frac{1}{4}$

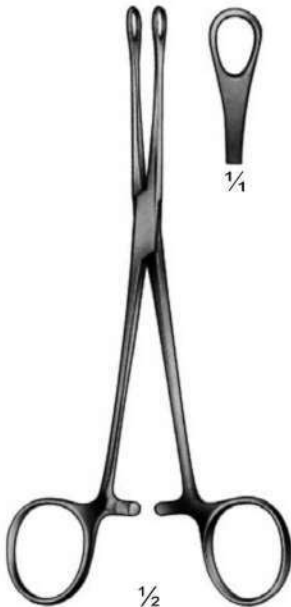

$\frac{1}{2}$   
Williams  
537-04-16  
16 cm / 6 $\frac{1}{4}$ "



$\frac{1}{4}$

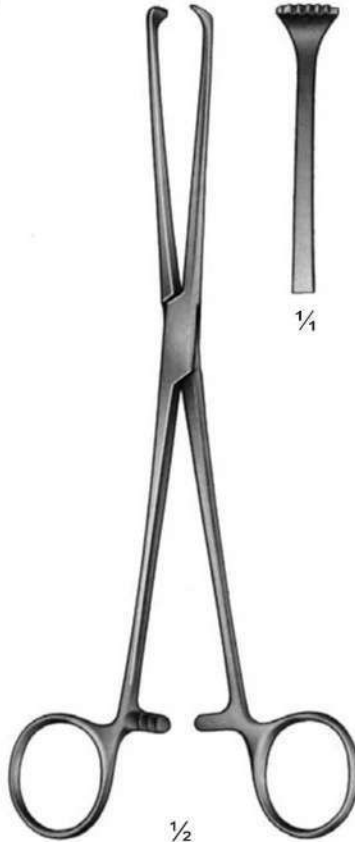

Allis  
537-05-22  
22 cm / 8 $\frac{3}{4}$ "



$\frac{1}{4}$

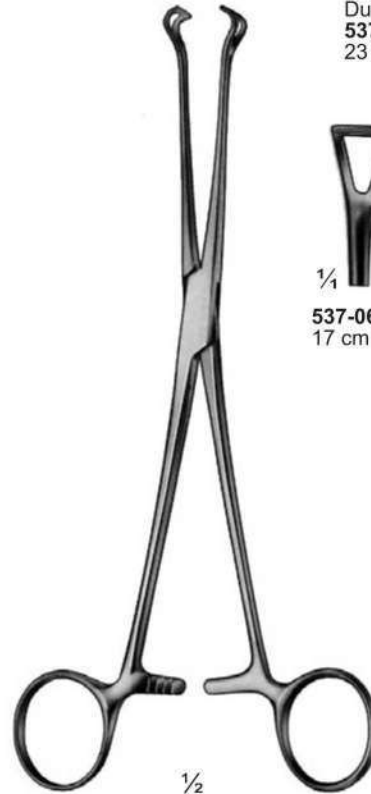

Babcock  
537-06-17 To 537-08-22



$\frac{1}{4}$   
537-06-17  
17 cm / 6 $\frac{3}{4}$ "



$\frac{1}{4}$   
537-07-21  
21.5 cm / 8 $\frac{1}{2}$ "



537-08-22  
22 cm / 8 $\frac{3}{4}$ "

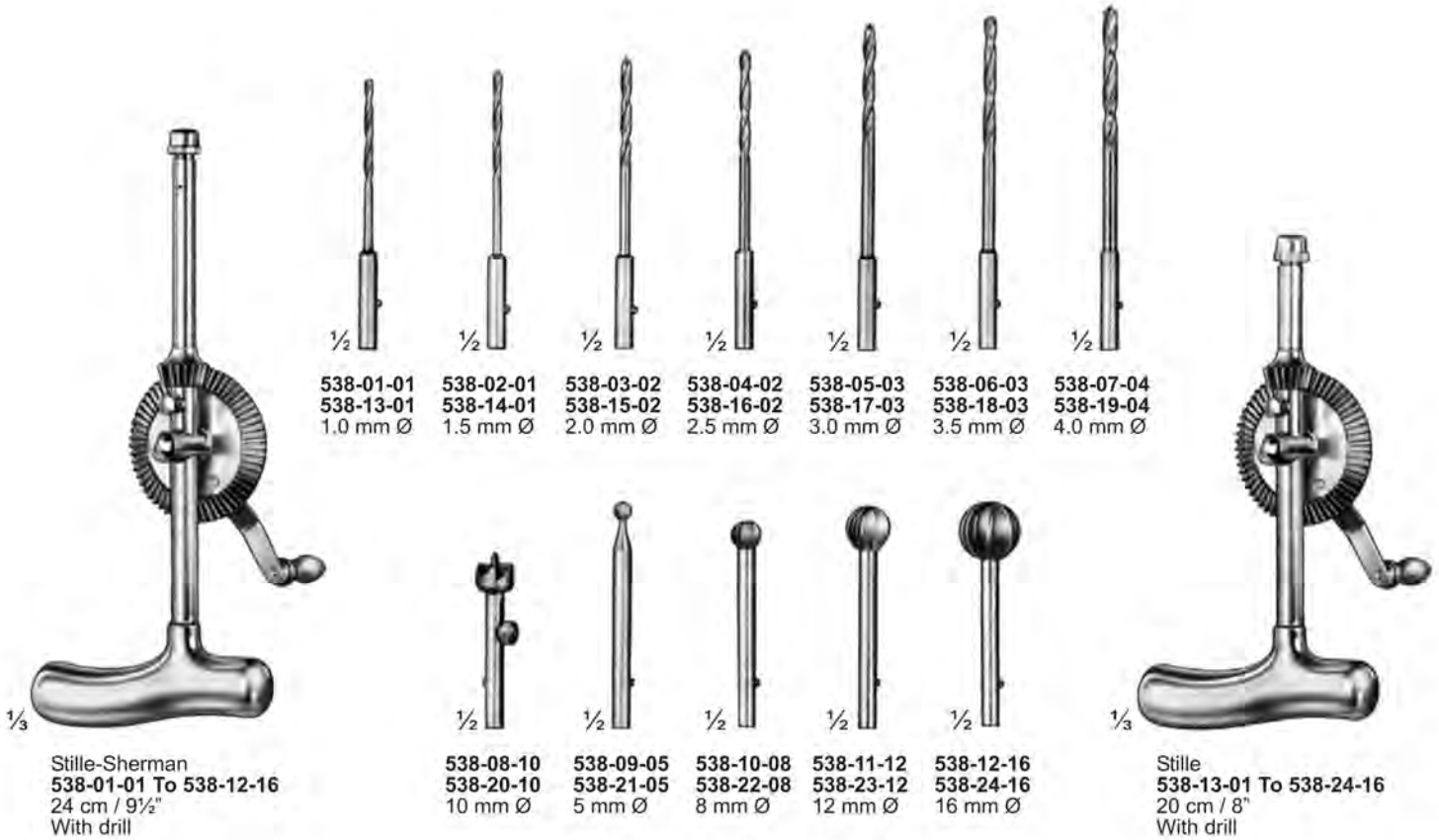



539-01-07 7 cm / 2¾" 3.2 mm Ø  
539-02-07 7 cm / 2¾" 3.2 mm Ø  
539-03-09 9 cm / 3½" 3.2 mm Ø

Moore  
539-01-07 To 539-03-09  
With 1 drill  
28.5 cm / 11¼"  
539-04-03  
With 3 drills



539-05-28  
28 cm / 11"

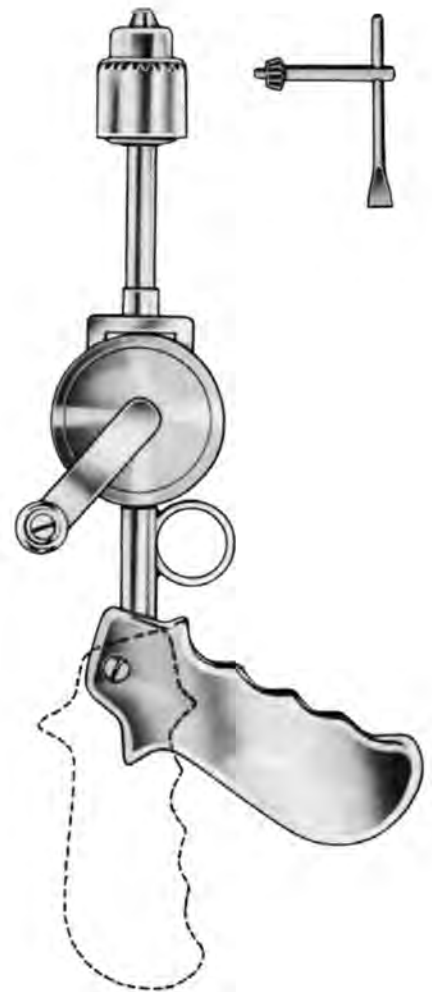

539-06-00  
With key

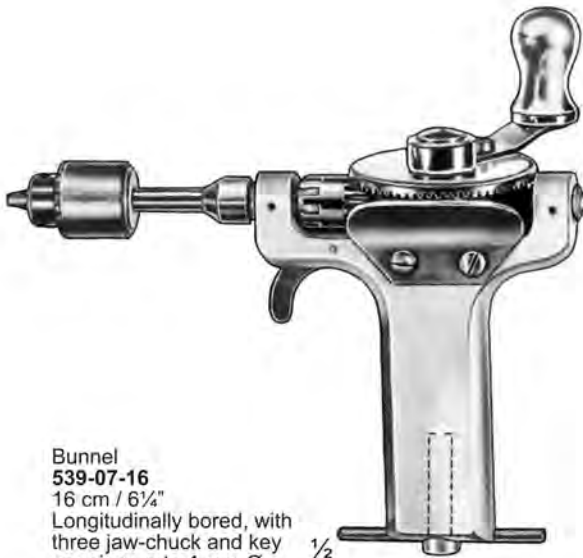

Bunnell  
539-07-16  
16 cm / 6¼"  
Longitudinally bored, with  
three jaw-chuck and key  
opening up to 4 mm Ø ½



Ralk  
539-08-16  
16 cm / 6¼"  
With three jaw-chuck and key  
opening up to 6.35 mm Ø ½

**Handbohrapparate  
Hand Drills  
Perforateurs à main**



**Extension piece**

**540-01-09**  
9 mm Ø

**540-02-14**  
14 mm Ø

**540-03-16**  
16 mm Ø

**540-04-22**  
22 mm Ø

**Cushing**  
**540-05-14**  
14 mm Ø

**540-06-02**  
2 mm Ø

**McKenzie**  
**540-07-13**  
13 mm Ø

**Errico**  
**540-08-16**  
16 mm Ø

**Perthes**  
**540-10-22**  
22 cm / 8¾"

**Hudson**  
**540-01-09 To 540-08-16**  
27 cm / 10½"  
**540-09-08**  
With 8 drills and extension piece

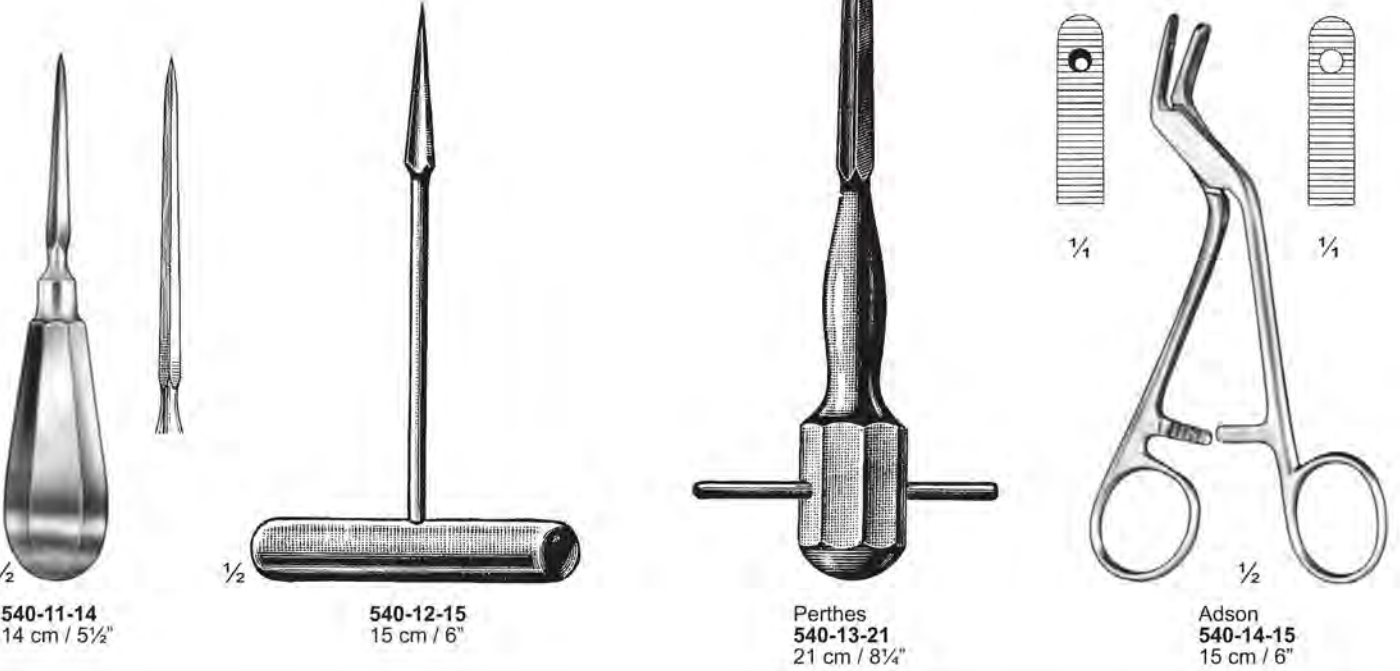

**540-11-14**  
14 cm / 5½"

**540-12-15**  
15 cm / 6"

**Perthes**  
**540-13-21**  
21 cm / 8¼"

**Adson**  
**540-14-15**  
15 cm / 6"



# Schraubendreher Screw Driver Tournevis



541-01-07  
7 cm / 2 3/4"

-



541-02-07  
7 cm / 2 3/4"

•



541-03-07  
7 cm / 2 3/4"

•



541-04-07  
7 cm / 2 3/4"

+



541-05-07  
7 cm / 2 3/4"

+



541-06-07  
7 cm / 2 3/4"

+



541-07-16  
16 cm / 6 1/4"  
Handle only with  
rapid chuck



541-08-05  
5.5 cm / 2 1/4"  
Chuck only



541-09-00  
Stainless case only  
541-10-00  
Complete set consisting  
541-01-07 To 541-08-05 packed  
in stainless case



541-11-17  
17 cm / 6 3/4"



1/4



541-12-17  
17 cm / 6 3/4"

Schraubendreher  
Screw Driver  
Tournevis



1/2  
Lane-25  
542-01-25  
25 cm / 10"



1/2  
Phillips  
542-02-26  
26 cm / 10 1/4"



1/2  
542-03-25  
25 cm / 10"



1/4



1/2  
Phillips  
542-04-17  
17 cm / 6 3/4"



1/4



1/2  
542-05-16  
16.5 cm / 6 1/2"



1/2  
542-06-13  
13 cm / 5 1/8"



1/2  
542-07-14  
14 cm / 5 1/2"



1/4

Schraubendreher  
Screw Driver  
Tournevis

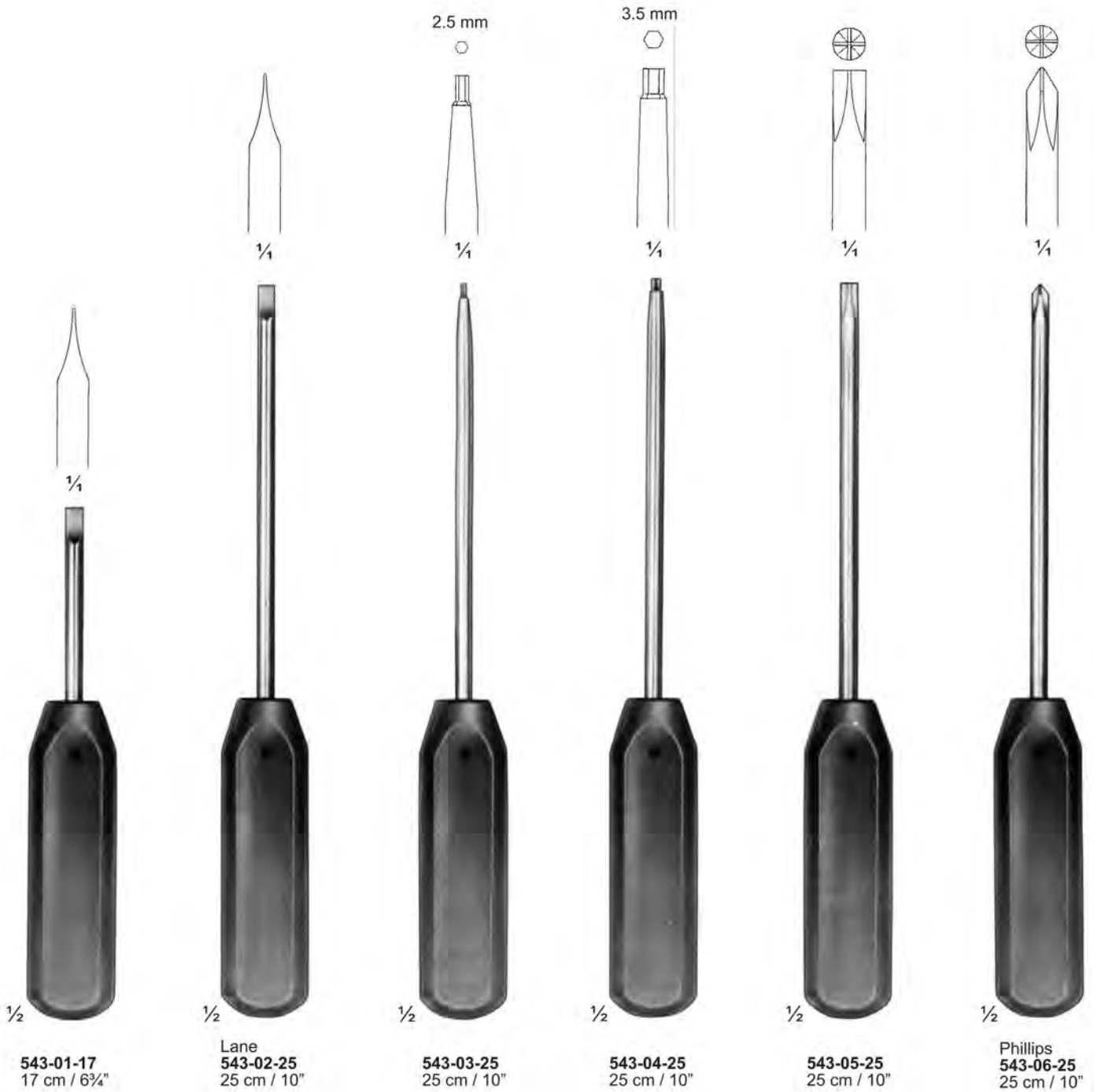



Beinen Sie Instruments Aus  
Bone Instruments  
Desosser Des Instruments

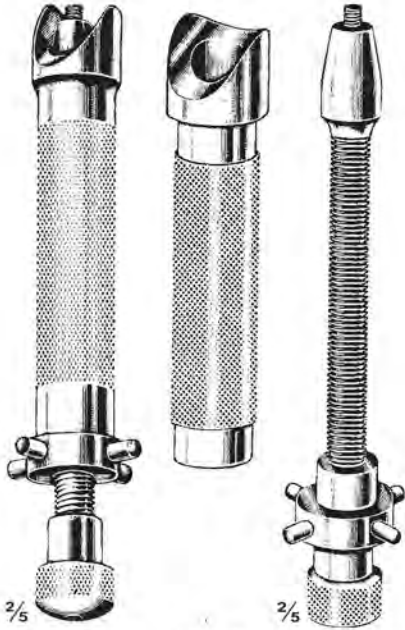

Lloyd  
544-01-20  
20 cm / 8"  
impactor and extractor



Jewett  
544-02-20  
20 cm / 8"



Jewett  
544-03-20  
20 cm / 8"



Lane  
544-04-18  
18 cm / 7"



544-05-24  
24 cm / 9½"



Lane  
544-06-22  
22 cm / 8¾"



Lane  
544-07-23  
23 cm / 9"



Lane  
544-08-18  
18 cm / 7"

**Extensionsbügel  
Extension Bows  
Etriers à extension**



- 545-01-15 15 mm
- 545-02-20 20 mm
- 545-03-25 25 mm
- 545-04-30 30 mm
- 545-05-35 35 mm
- 545-06-40 40 mm
- 545-07-45 45 mm
- 545-08-50 50 mm
- 545-09-55 55 mm
- 545-10-60 60 mm
- 545-11-65 65 mm
- 545-12-70 70 mm

Palmer  
545-01-15 To 545-12-70  
1.5 mm Ø

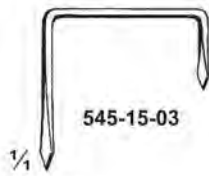
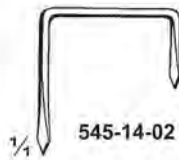
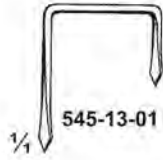

Wilberg  
545-13-01 To 545-15-03  
Clips



Kirschner  
545-16-03  
6 X 6 cm / 2 1/2 X 2 1/2"  
With 3 traction hooks

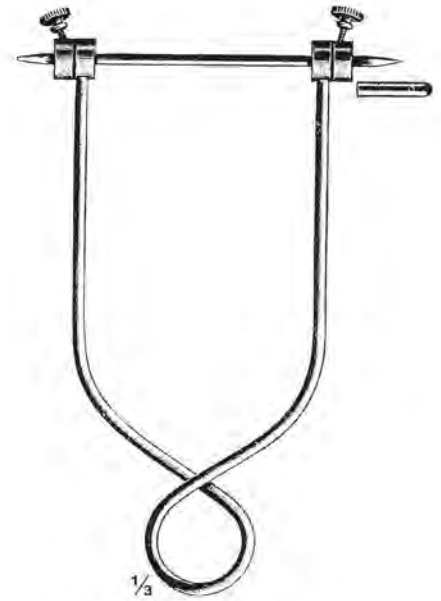

Bohler  
545-17-16 16 X 9 cm / 6 1/4 X 3 1/2"  
For arm, With 1 pin  
545-18-21 21 X 11 cm / 8 1/4 X 4 1/2"  
For thigh and knee, With 1 pin  
545-19-21 21 X 15 cm / 8 1/4 X 6"  
For femur and knee, With 1 pin



Schwarz  
545-20-01  
For finger wires  
up to 1.6mm Ø

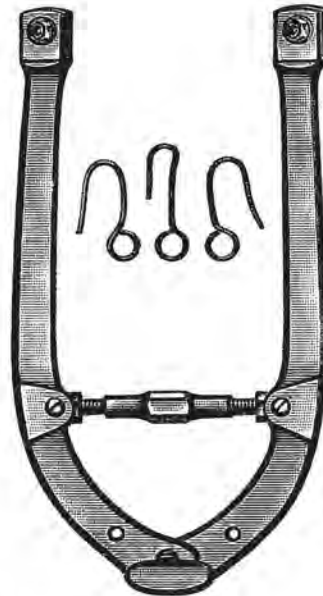

Kirschner  
545-21-03 4-14 X 11.5 cm / 1 1/2-5 1/2 X 4 1/2"  
545-22-03 6.5-15 X 11 cm / 2 1/2-6 X 4 1/4"  
545-23-03 6-22 X 18 cm / 2 1/4-8 3/4 X 7"  
With 3 traction hooks

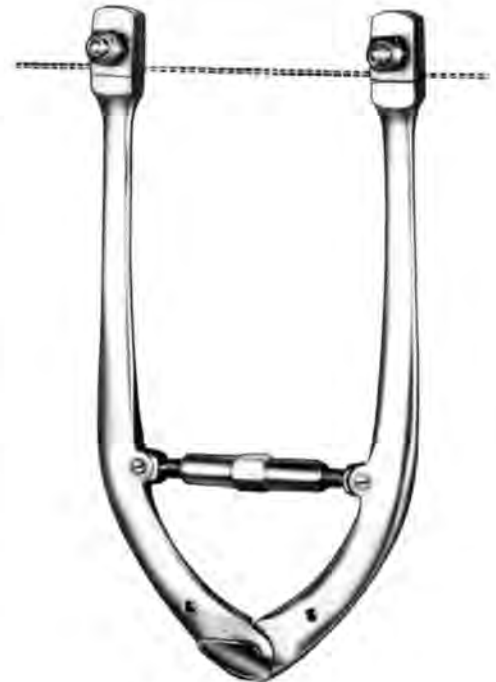

545-24-18  
18 X 10 cm / 7 X 4"  
545-25-27  
27 X 27 cm / 10 1/2 X 10 1/2"

**Extensionsbügel  
Extension Bows  
Etriers à extension**



**Kirschner**  
**546-01-03** 0-40 mm X 18.5 cm / 7 1/4"  
**546-02-03** 35-200 mm X 27 cm / 10 1/2"  
 With 3 traction pins

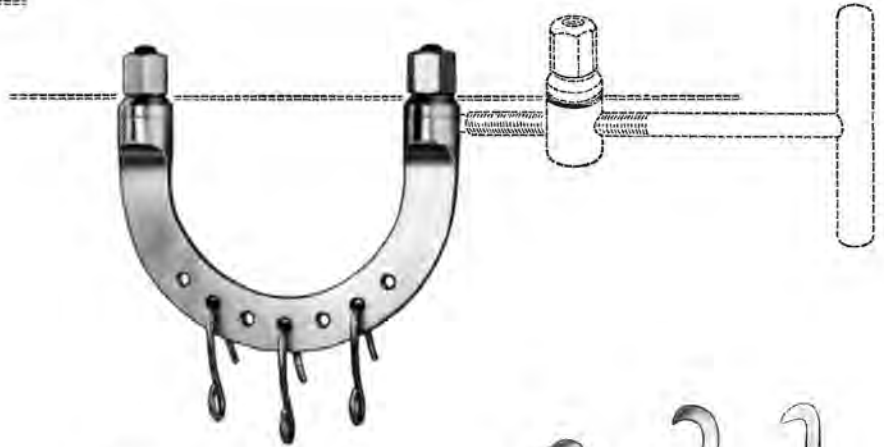

**Kirschner**  
**546-03-03** 9.5 X 7 cm / 3 3/4 X 2 3/4"  
**546-04-03** 10.5 X 10.5 cm / 4 1/4 X 4 1/4"  
**546-05-03** 12 X 12 cm / 4 3/4 X 4 3/4"  
**546-06-03** 15 X 15 cm / 6 X 6"  
**546-07-03** 20 X 15 cm / 8 X 6"  
 With 3 traction pins

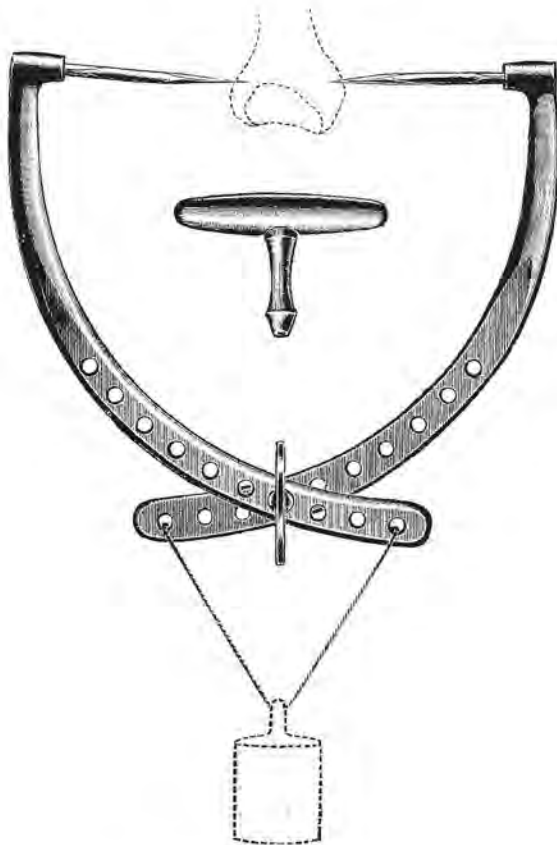
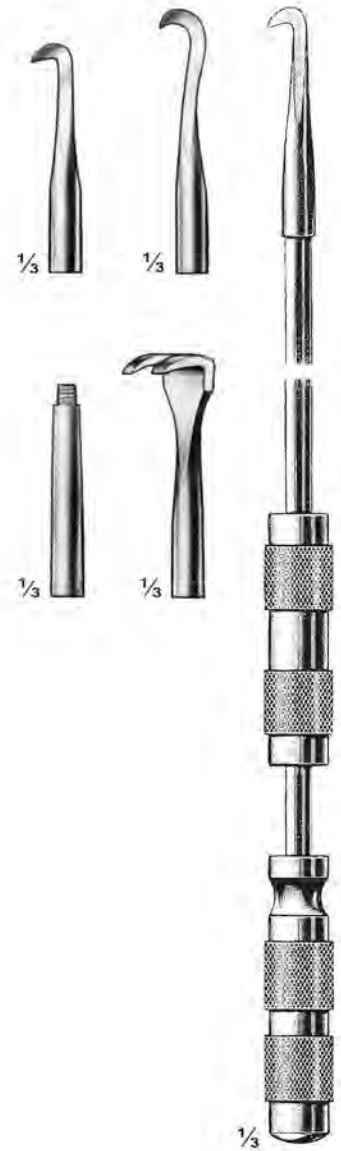

**Steinmann**  
**546-08-00**  
 Complete consisting :  
 1 Key, 2 Pins 8mm, 2 Pins 10 mm,  
 2 Pins 12 mm, 2 Pins 14mm,  
 2 Pins 16 mm, 2 Pins 20 mm

**Kuntscher**  
**546-09-45**  
 45 cm / 17 3/4"  
 With 4 tips



**Extensionsbügel  
Extension Bows  
Etriers à extension**



1/3

Demel  
547-01-27 To 547-03-30

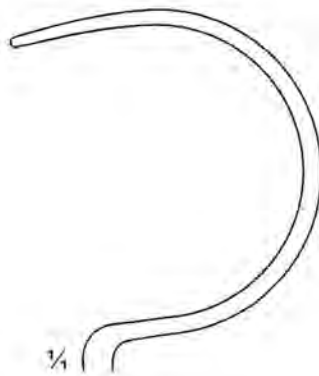

1/4  
**547-01-27**  
27.5 cm / 10 3/4"

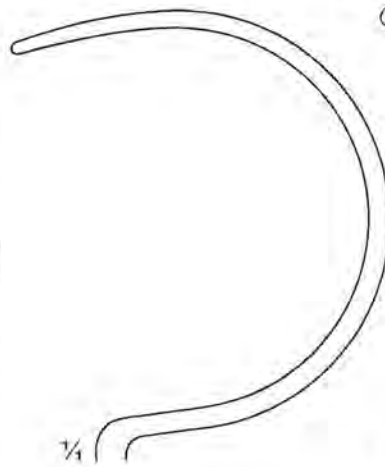

1/4  
**547-02-28**  
28.5 cm / 11 1/4"

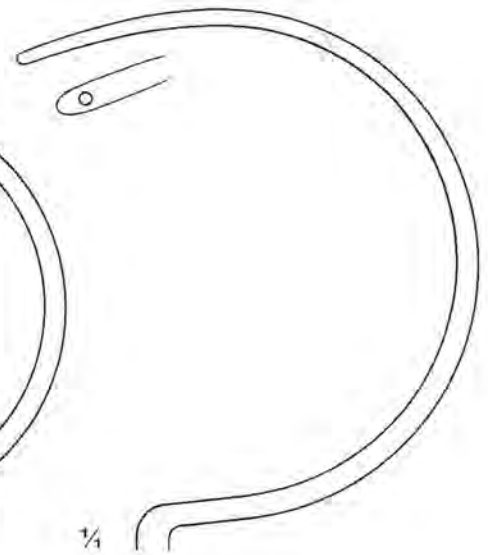

1/4  
**547-03-30**  
30 cm / 12"

**Drahtumföhrungsnadeln  
Wire Guides  
Aiguiles Passe-fils**



548-01-24 & 548-02-27

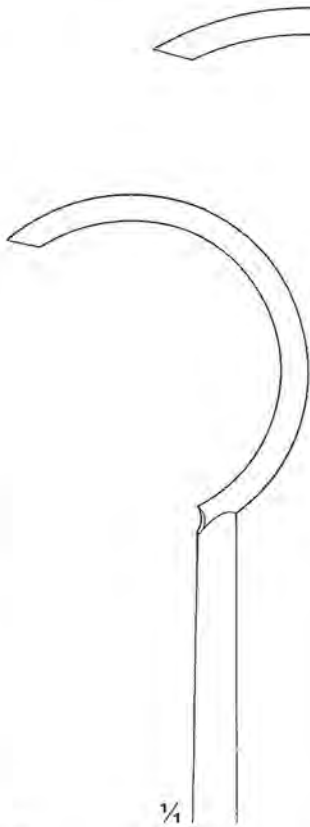

548-01-24  
24 cm / 9½"

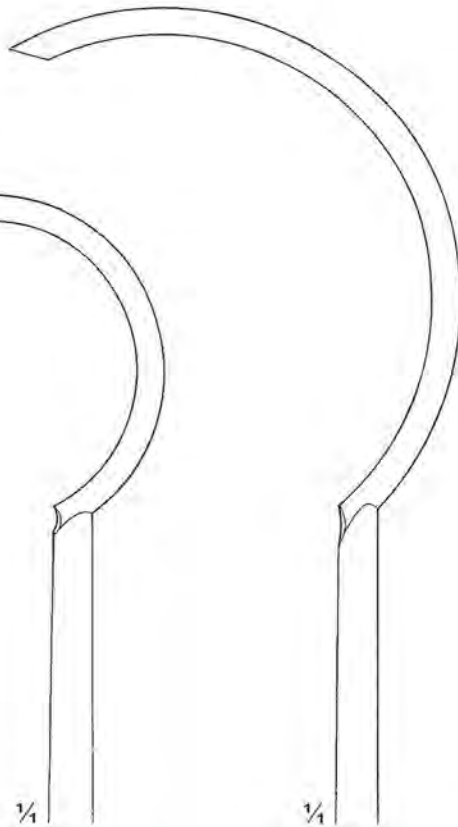

548-02-27  
27 cm / 10½"

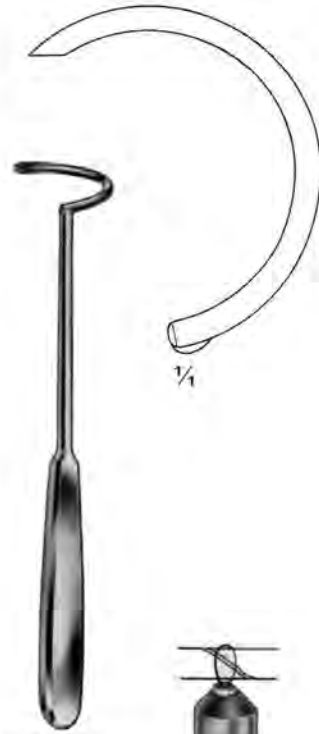

548-03-23  
23 cm / 9"



Parham  
548-04-23  
23 cm / 9"



Parham  
548-05-18 18 cm / 7" X 5 mm  
548-06-20 20 cm / 8" X 5 mm  
548-07-25 25 cm / 10" X 3 mm  
548-08-25 25 cm / 10" X 5 mm  
548-09-30 30 cm / 12" X 5 mm

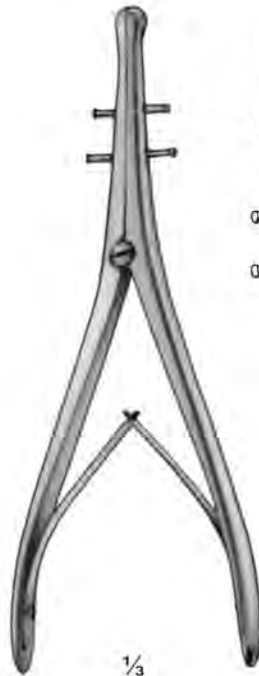

Demel  
548-10-27  
27 cm / 10½"



Loute  
548-11-22  
22 cm / 8¾"

Flachzangen  
Flat Nose Pliers  
Pincès Plates



1/2  
549-01-14  
14 cm / 5 1/2"



1/2  
549-02-14  
14 cm / 5 1/2"

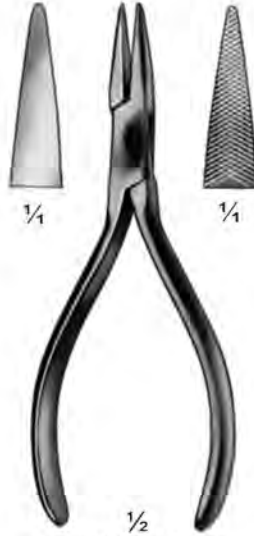

1/2  
549-03-14  
14 cm / 5 1/2"



1/2  
549-04-16  
16 cm / 6 1/4"



1/2  
549-05-16  
16 cm / 6 1/4"



1/2  
549-06-16  
16.5 cm / 6 1/2"



1/4  
549-07-17



1/2  
549-07-17 & 549-08-17  
17 cm / 6 3/4"



1/4  
549-08-17



1/2  
549-09-19  
19 cm / 7 1/2"

**Flachzangen  
Flat Nose Pliers  
Pincès Plates**



1/4



1/2  
550-01-17  
17 cm / 6 3/4"



1/4



1/2  
550-02-18 & 550-03-18  
18 cm / 7"



1/4

550-02-18



1/4

550-03-18



Parallel  
action



1/2  
550-04-13 & 550-05-18



1/4

550-04-13  
13 cm / 5 1/8"



1/4

550-05-18  
18 cm / 7"



1/2  
550-06-14 To 550-09-18



1/4

550-06-14  
14.5 cm / 5 3/4"



1/4

550-07-18  
18 cm / 7"



1/4

550-08-18  
18 cm / 7"



1/4

550-09-18  
18 cm / 7"



1/4

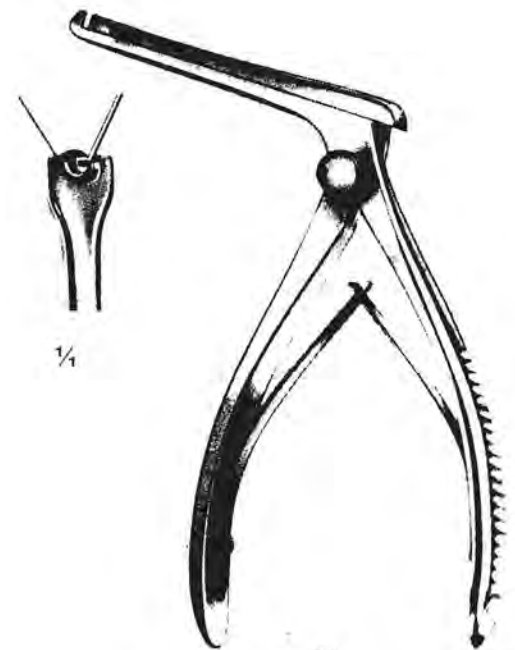

1/2  
550-10-17  
17 cm / 6 3/4"

Flachzangen  
Flat Nose Pliers  
Pincès Plates

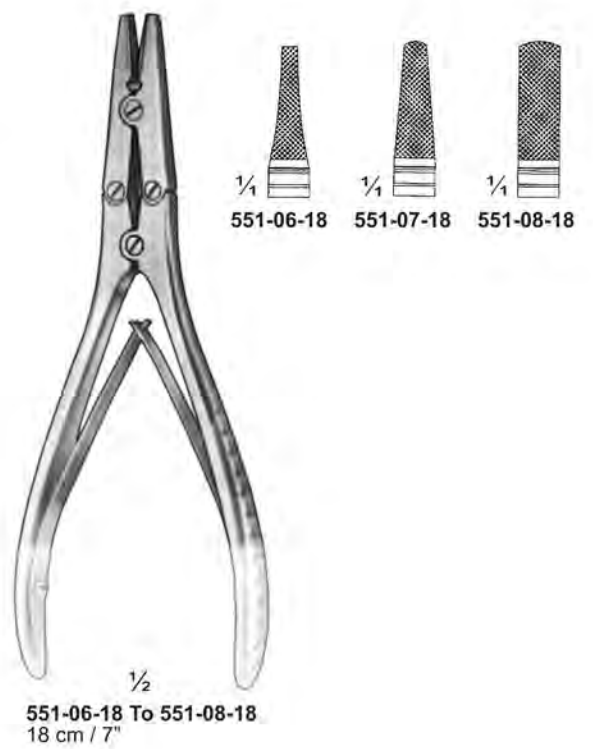



**Drahtkneifzangen  
Wire Cutting Pliers  
Pinces à couper le fil**

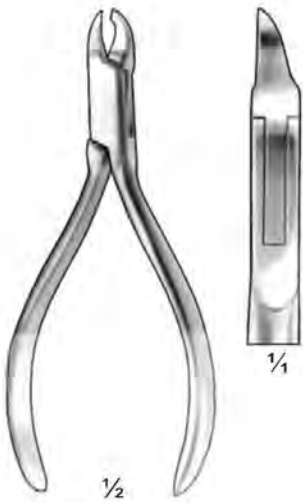

Angle  
552-01-13  
13 cm / 5 1/4"



552-02-14  
14 cm / 5 1/2"



552-03-15  
15 cm / 6"



552-04-16  
16 cm / 6 1/4"



552-05-16  
16 cm / 6 1/4"



552-06-16  
16 cm / 6 1/4"



552-07-14  
14.5 cm / 5 3/4"



552-08-14  
14.5 cm / 5 3/4"

**Drahtkneifzangen  
Wire Cutting Pliers  
Pincès à couper le fil**



1/2  
553-01-14  
14 cm / 5 1/2"



1/2  
Reill  
553-02-18  
18 cm / 7"

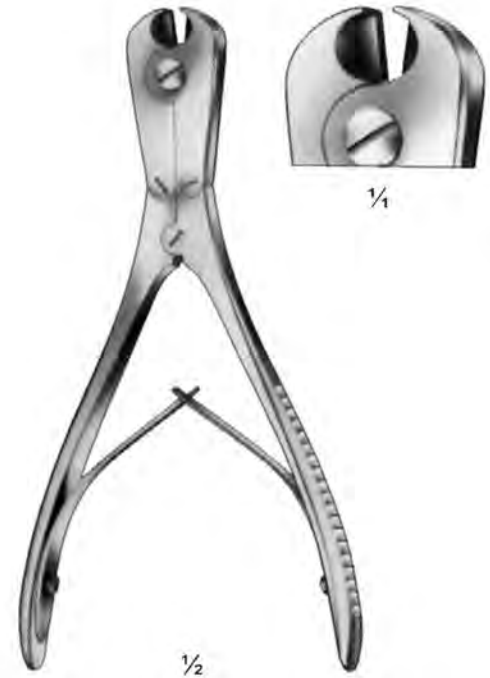

1/2  
553-03-18  
18 cm / 7"



1/2  
553-04-23  
23 cm / 9"  
553-04-23 & 553-05-25



1/2  
553-05-25  
25cm / 10"



1/2  
553-06-22  
22 cm / 8 3/4"

**Drahtkneifzangen**  
**Wire Cutting Pliers**  
**Pincès à couper le fil**

With tungsten carbide inserts

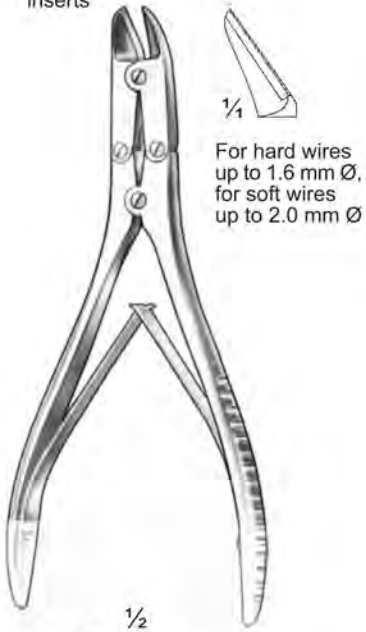

For hard wires up to 1.6 mm Ø, for soft wires up to 2.0 mm Ø

$\frac{1}{2}$   
**554-01-16**  
 16 cm / 6½"



For wires up to 2.5 mm Ø

$\frac{1}{2}$   
**554-02-22**  
 22 cm / 8¾"

With tungsten carbide inserts



For soft wires up to 2.0 mm Ø

For soft wires up to 1.5 mm Ø

$\frac{1}{2}$   
**554-03-18**  
 18 cm / 7"



$\frac{1}{3}$   
**554-04-32**  
 32 cm / 12¾"



For cutting off Kirschner wires, tibia head screw, bolts, pins, up to 3mm Ø



$\frac{1}{2}$   
**554-05-23**  
 23.5 cm / 9¼"

**Drahtkneifzangen**  
**Wire Cutting Pliers**  
**Pinces à couper le fil**



**555-02-47**  
47 cm / 18½"  
For cutting off Kirschner wires  
up to 6 mm Ø



½  
**555-01-24**  
24 cm / 9½"



⅔  
**555-03-30** 30 cm / 12"  
**555-04-40** 40 cm / 16"  
With Tungsten carbide inserts



556-01-13  
13 cm / 5 1/8"  
19 mm Ø



556-02-15  
15 cm / 6"  
18 mm Ø



556-03-15  
15 cm / 6"  
30 mm Ø



556-04-15  
15 cm / 6"  
30 mm Ø



1/4  
556-05-15  
15 cm / 6"  
18 mm Ø



557-01-11  
11 cm / 4¼"  
24 mm Ø



557-02-14  
14 cm / 5½"  
28 mm Ø



557-03-16  
16 cm / 6¼"  
37 mm Ø



557-04-14  
14 cm / 5½"  
30 mm Ø

Laryngoskope und Zubehör  
 Laryngoscope and Accessories  
 Laryngoscopes et accessoires

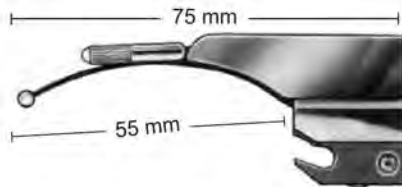

McIntosh  
 558-01-00  
 No. 0, 75 mm

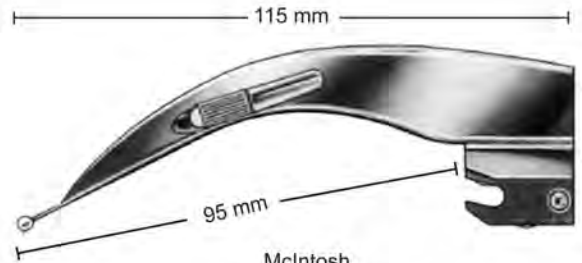

McIntosh  
 558-03-02  
 No. 2, 115 mm

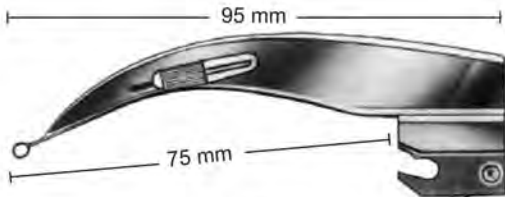

McIntosh  
 558-02-01  
 No. 1, 95 mm

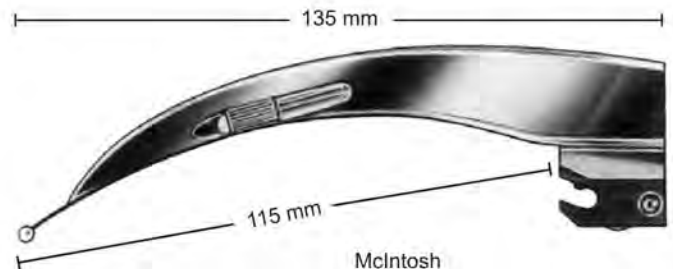

McIntosh  
 558-04-03  
 No. 3, 135 mm

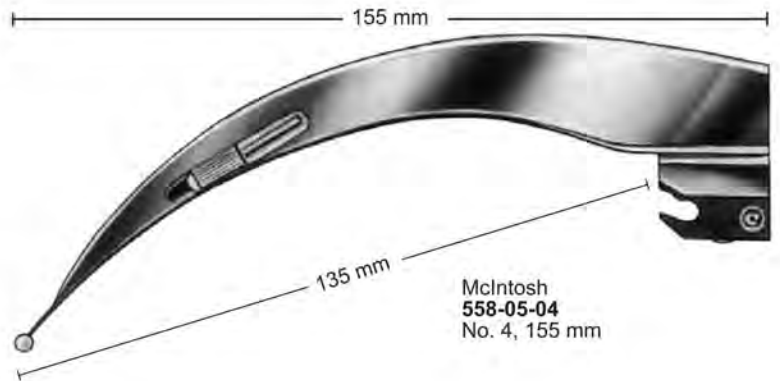

McIntosh  
 558-05-04  
 No. 4, 155 mm

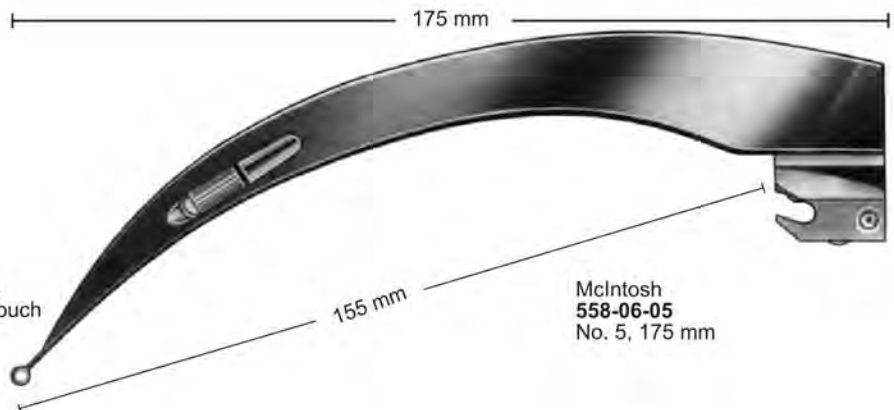

McIntosh  
 558-06-05  
 No. 5, 175 mm

McIntosh  
 558-07-03 With handle and 3 blades No. 1, 2, 3  
 558-08-04 With handle and 4 blades No. 1, 2, 3, 4  
 558-09-05 With handle and 5 blades No. 0, 1, 2, 3, 4  
 558-10-06 With handle and 6 blades No. 0, 1, 2, 3, 4, 5  
 Available in Plastic, wooden case, leather and canvas pouch

**Laryngoskope und Zubehör**  
**Laryngoscope and Accessories**  
**Laryngoscopes et accessoires**



Negus  
**559-01-00**  
 No. 0, 75 mm

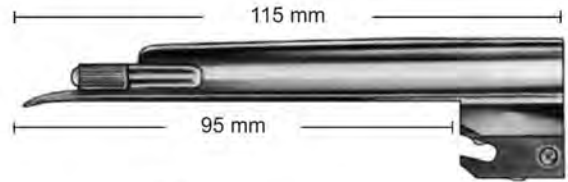

Negus  
**559-03-02**  
 No. 2, 115 mm



Negus  
**559-02-01**  
 No. 1, 95 mm

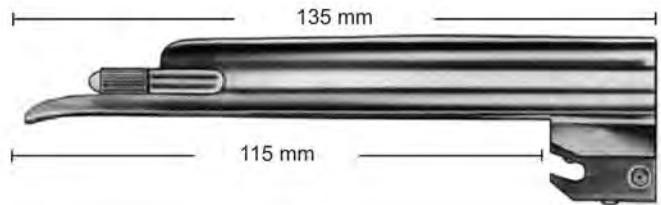

Negus  
**559-04-03**  
 No. 3, 135 mm

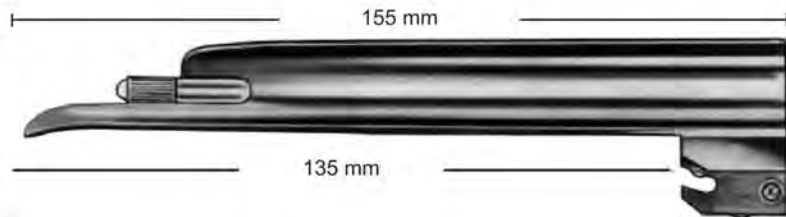

Negus  
**559-05-04**  
 No. 4, 155 mm



Negus  
**559-06-03** With handle and 3 blades No. 1, 2, 3  
**559-07-04** With handle and 4 blades No. 1, 2, 3, 4  
**559-08-05** With handle and 5 blades No. 0, 1, 2, 3, 4  
 Available in Plastic, wooden case, leather and canvas pouch



**Laryngoskope und Zubehör**  
**Laryngoscope and Accessories**  
**Laryngoscopes et accessoires**



Foregger  
**560-01-00**  
No. 0, 75 mm

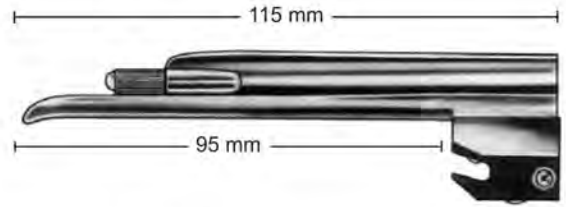

Foregger  
**560-03-02**  
No. 2, 115 mm



Foregger  
**560-02-01**  
No. 1, 95 mm

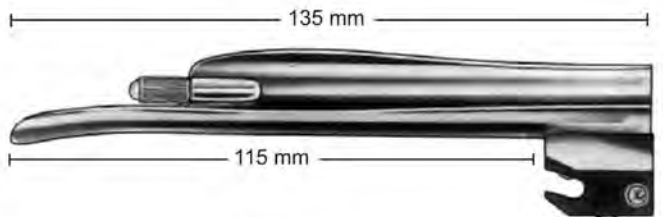

Foregger  
**560-04-03**  
No. 3, 135 mm

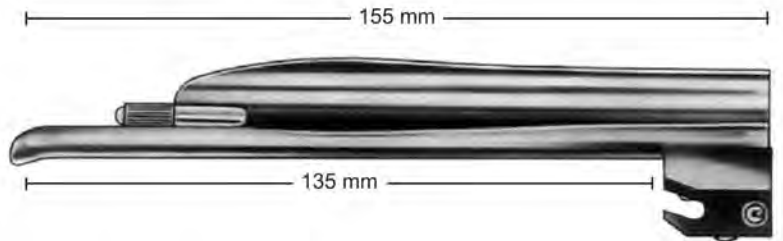

Foregger  
**560-05-04**  
No. 4, 155 mm



Foregger  
**560-06-03** With handle and 3 blades No. 1, 2, 3  
**560-07-04** With handle and 4 blades No. 1, 2, 3, 4  
**560-08-05** With handle and 5 blades No. 0, 1, 2, 3, 4  
Available in Plastic, wooden case, leather and canvas pouch

**Laryngoskope und Zubehör**  
**Laryngoscope and Accessories**  
**Laryngoscopes et accessoires**

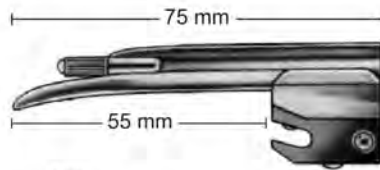

Miller  
**561-01-00**  
No. 0, 77 mm

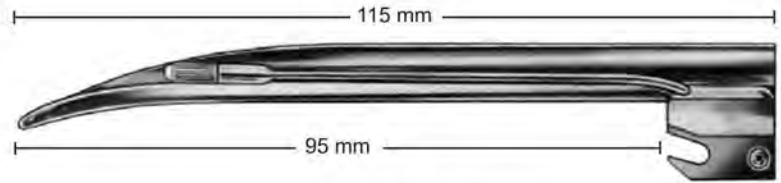

Miller  
**561-03-02**  
No. 2, 155 mm

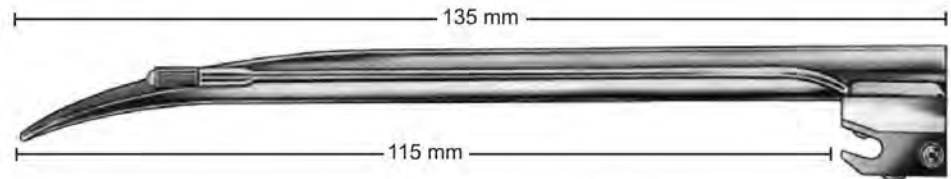

Miller  
**561-04-03**  
No. 3, 197 mm



Miller  
**561-02-01**  
No. 1, 100 mm



Miller  
**561-05-04**  
No. 4, 203 mm



Miller  
**561-06-03** With handle and 3 blades No. 1, 2, 3  
**561-07-04** With handle and 4 blades No. 1, 2, 3, 4  
**561-08-05** With handle and 5 blades No. 0, 1, 2, 3, 4  
Available in Plastic, wooden case, leather and canvas pouch

**Mundkeile  
Mouth Gag  
Baillons**



1/2  
**Denhardt**  
**562-01-12**  
12 cm / 4 3/4"



1/2  
**Denhardt**  
**562-02-12**  
12.5 cm / 5"



1/2  
**Fergusson-Ackland**  
**562-03-14**  
14.5 cm / 5 3/4"



1/2  
**Roser-Koenig**  
**562-04-16** 16 cm / 6 1/4"  
**562-05-19** 19 cm / 7 1/2"



1/2  
**Roser-Koenig**  
**562-06-16** 16 cm / 6 1/4"  
**562-07-19** 19 cm / 7 1/2"



1/2  
**Mason-Ackland**  
**562-08-14** 14 cm / 5 1/2"  
**562-09-16** 16 cm / 6 1/4"  
**562-10-18** 18 cm / 7"  
**562-11-20** 20 cm / 8"



1/2  
**Mason-Ackland**  
**562-12-16** 16 cm / 6 1/4"  
**562-13-18** 18 cm / 7"  
**562-14-20** 20 cm / 8"



1/2  
**Mason**  
**562-15-14** 14 cm / 5 1/2"  
**562-16-16** 16 cm / 6 1/4"  
**562-17-18** 18 cm / 7"  
**562-18-20** 20 cm / 8"

**Mundkeile  
Mouth Gag  
Baillons**



1/2

Heister  
563-01-13  
13 cm / 5 1/8"



Heister  
563-02-13  
13 cm / 5 1/8"



1/2

Doyen-Collin  
563-03-13 13 cm / 5 1/8"  
563-04-15 15 cm / 6"



1/2

Molt  
563-05-11 11 cm / 4 1/4"  
563-06-14 14 cm / 5 1/2"



1/2

Doyen-Jansen  
563-07-10 10 cm / 4"  
563-08-15 15 cm / 6"



Featherstone  
563-09-16  
16.5 cm / 6 1/2"



Jenning  
563-10-11 11 cm / 4 1/4"  
563-11-13 13 cm / 5 1/8"

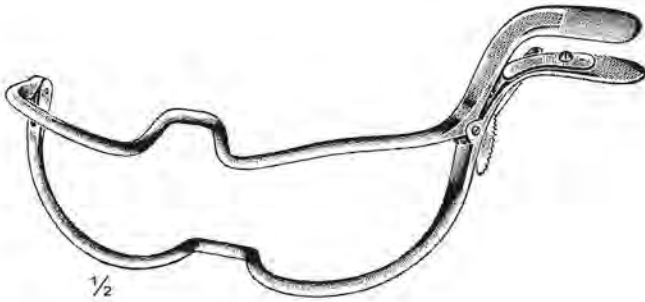

Jennings  
564-01-09 9 cm / 3 1/2"  
564-02-11 11 cm / 4 1/4"  
564-03-13 13 cm / 5 1/8"  
564-04-15 15 cm / 6"

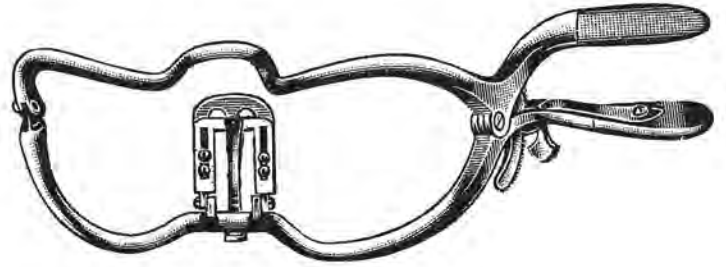

Jennings  
564-05-09 9 cm / 3 1/2"  
564-06-11 11 cm / 4 1/4"  
564-07-13 13 cm / 5 1/8"  
564-08-15 15 cm / 6"

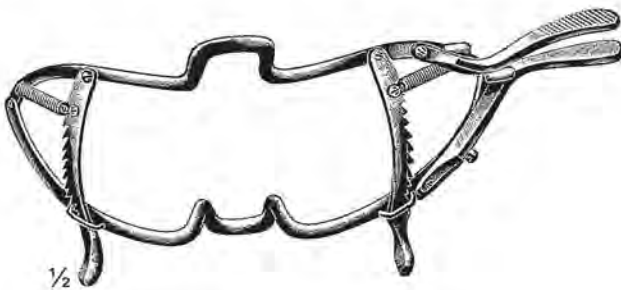

Whitehead  
564-09-09 9 cm / 3 1/2"  
564-10-11 11 cm / 4 1/4"  
564-11-13 13 cm / 5 1/8"  
564-12-15 15 cm / 6"

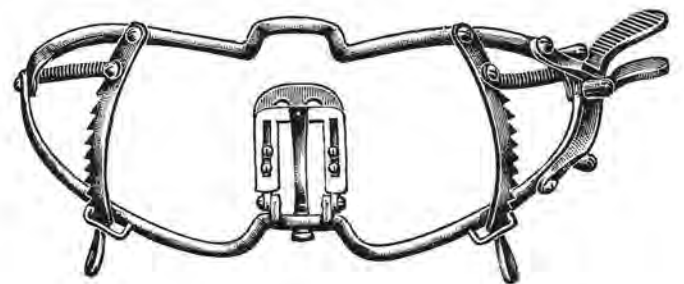

Whitehead  
564-13-09 9 cm / 3 1/2"  
564-14-11 11 cm / 4 1/4"  
564-15-13 13 cm / 5 1/8"  
564-16-15 15 cm / 6"

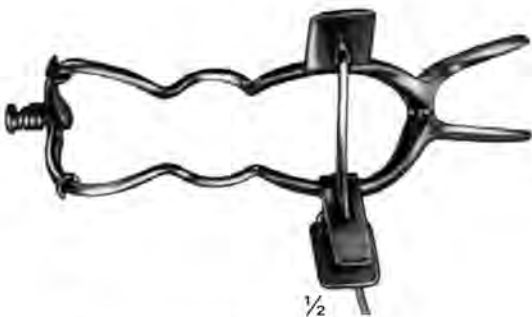

Seemann-Seiffert (Soft-retaining)  
564-17-09 9 cm / 3 1/2"  
564-18-11 11 cm / 4 1/4"  
564-19-13 13 cm / 5 1/8"  
564-20-15 15 cm / 6"



Seemann-Seiffert  
564-21-11 11 cm / 4 1/4"  
564-22-13 13 cm / 5 1/8"



Jennings  
**565-01-09** 9 cm / 3½"  
**565-02-11** 11 cm / 4¼"  
**565-03-13** 13 cm / 5" ⅛  
**565-04-15** 15 cm / 6"



Oringer  
**565-05-00** No. 0, For children  
**565-06-01** No. 1  
**565-07-02** No. 2  
**565-08-03** No. 3  
**565-09-00** Complete set No. 0-3

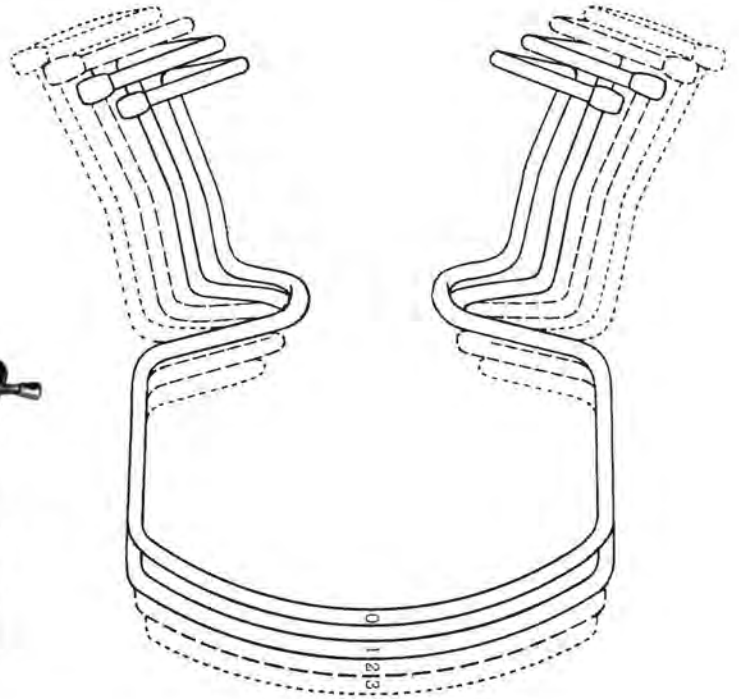

No. 1  
 No. 2  
 No. 3



Kilner-Dott  
**565-10-00**  
 Complete consisting :  
 1 Frame  
 3 Blades No. 1, 2, 3



No. 1  
 No. 2  
 No. 3



Kilner-Russel  
**565-11-00**  
 Complete consisting :  
 1 Frame  
 3 Blades No. 1, 2, 3

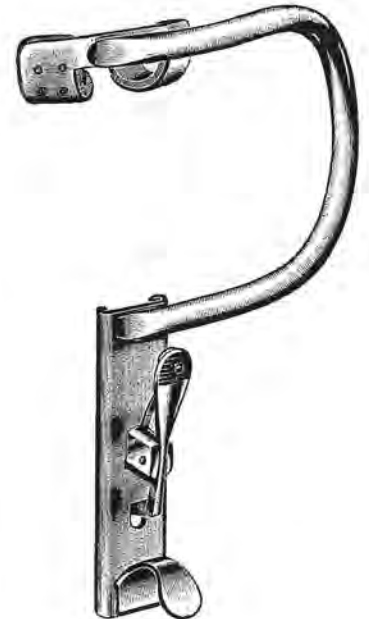

Davis-Boyle  
**566-01-20 To 566-05-26**  
Blades only  
**566-06-00**  
Complete consisting :  
1 Frame 566-07-00  
5 Blades

Davis-Boyle  
**566-07-00**  
Frame only

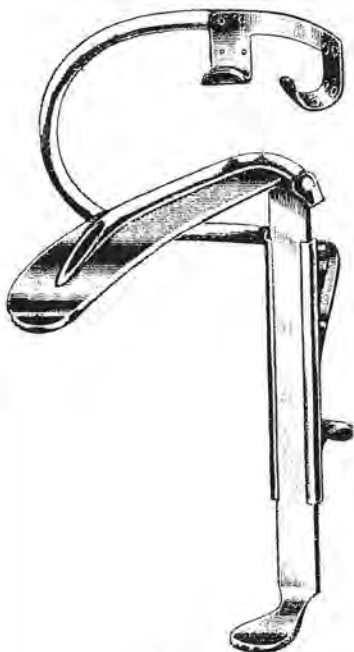

Davis-Boyle, Left  
**566-08-26 To 566-12-20**  
Blades with suction device  
**566-13-00**  
Complete consisting :  
1 Frame  
5 Blades

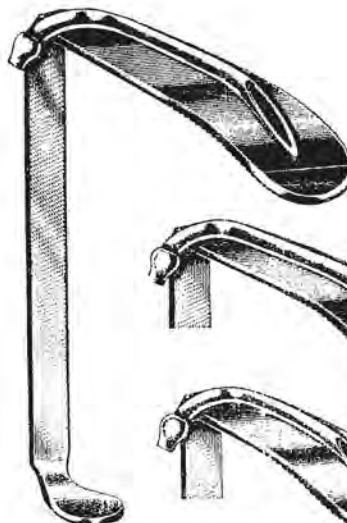

**566-08-26**  
**566-14-26**  
26 X 110 mm

**566-09-25**  
**566-15-25**  
25 X 90 mm

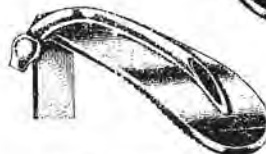

**566-10-24**  
**566-16-24**  
24 X 75 mm

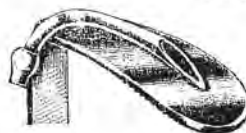

**566-11-22**  
**566-17-22**  
22 X 65 mm



**566-12-20**  
**566-18-20**  
20 X 25 mm

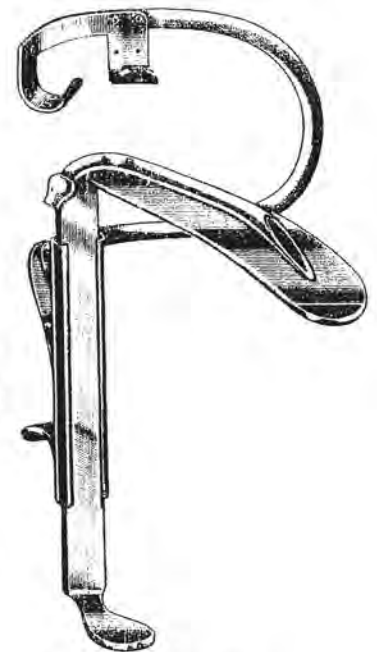

Davis-Boyle, Right  
**566-14-26 To 566-18-20**  
Blades with suction device  
**566-19-00**  
Complete consisting :  
1 Frame  
5 Blades

Mundkeile  
Mouth Gag  
Baillons



567-03-26  
26 X 100 mm

567-02-25  
25 X 86 mm

567-01-23  
23 X 70 mm

Mclvor  
567-01-26 To 567-03-23  
Blades only  
567-04-00  
Complete consisting :  
1 Frame 567-09-00  
3 Blades

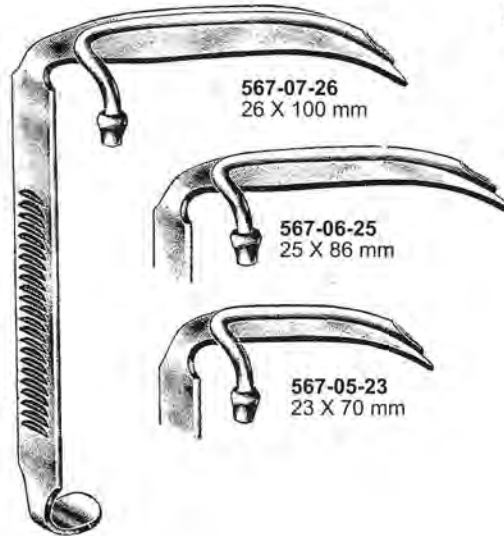

567-07-26  
26 X 100 mm

567-06-25  
25 X 86 mm

567-05-23  
23 X 70 mm

Mclvor  
567-05-26 To 567-07-23  
Blades with suction device  
567-08-00  
Complete consisting :  
1 Frame 567-09-00  
3 Blades



Mclvor  
567-09-00  
Frame only



Dingman  
567-10-01 To 567-12-03  
Blades only  
567-13-00  
Complete consisting :  
1 Frame  
3 Blades  
2 Retractors



567-10-01



567-11-02



567-12-03



Mundkeile  
Mouth Gag  
Baillons



1/2  
Kilner-Doughty  
568-01-01 To 568-03-03  
Blades only  
568-04-00  
Complete consisting :  
1 Frame  
3 Blades  
2 Adjustable tooth plates  
1 Palatal support toothless



1/2  
568-01-01



1/2  
568-02-02



1/2  
568-03-03



1/2



568-05-00  
Chest support for mouth gag

Mundkeile  
Mouth Gag  
Baillons

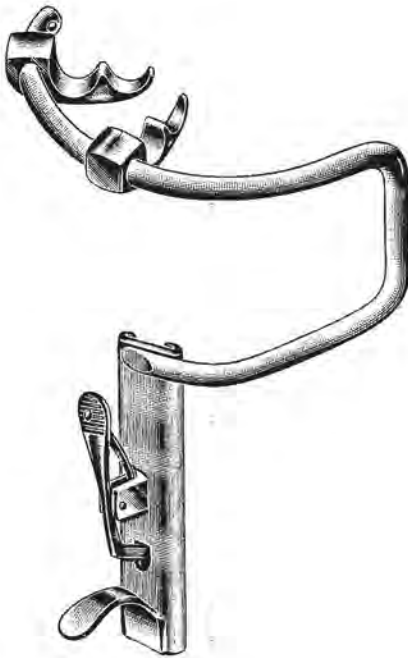

Negus  
569-01-32 To 569-03-27  
Blades with suction device  
569-04-00  
Complete consisting :  
1 Frame  
3 Blades  
2 Adjustable tooth plates

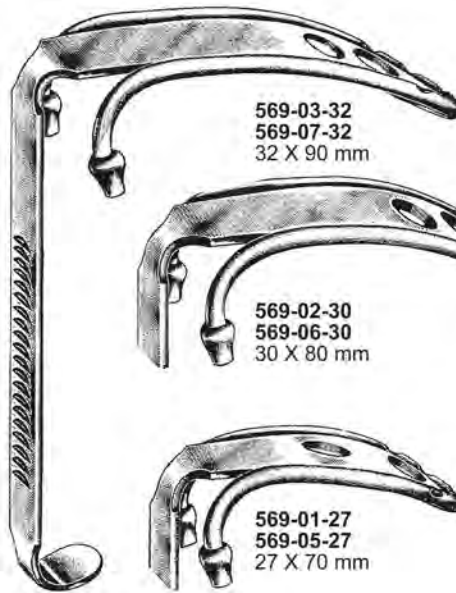

569-03-32  
569-07-32  
32 X 90 mm

569-02-30  
569-06-30  
30 X 80 mm

569-01-27  
569-05-27  
27 X 70 mm

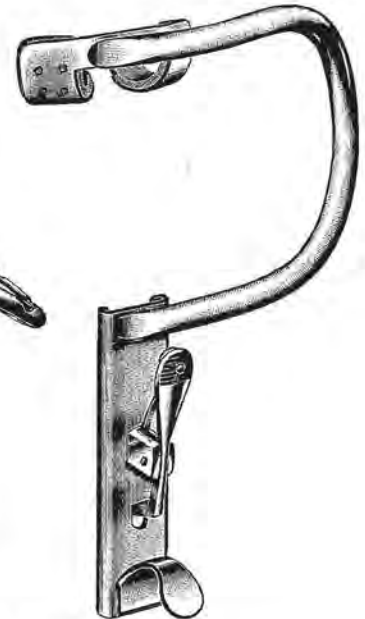

Negus  
569-05-32 To 569-07-27  
Blades with suction device  
569-08-00  
Complete consisting :  
1 Frame, Standard  
3 Blades



569-09-15  
15 cm / 6"  
For infants

569-10-20  
20 cm / 8"  
For children

569-11-25  
25 cm / 10"  
For adults

Magil  
569-09-15 To 569-11-25



16 mm

569-12-14  
14.5 cm / 5 3/4"



19 mm

569-13-14  
14 cm / 5 1/2"

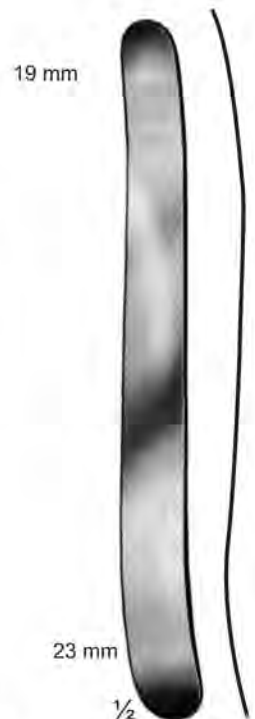

19 mm

23 mm

Buchwald  
569-14-18  
18 cm / 7"

Mundsperrer  
 Mouth Gag  
 Ouvre-bouche



1/2  
 570-01-14  
 14.5 cm / 5 3/4"



1/2  
 Mayo  
 570-02-17  
 17 cm / 6 3/4"

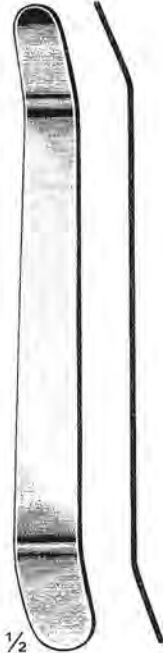

1/2  
 570-03-16  
 16.5 cm / 6 1/2"



1/2  
 Bruenings  
 570-04-19  
 19 cm / 7 1/2"



Doyen  
 570-05 13 cm / 5 1/8"  
 570-06 16 cm / 6 1/4"

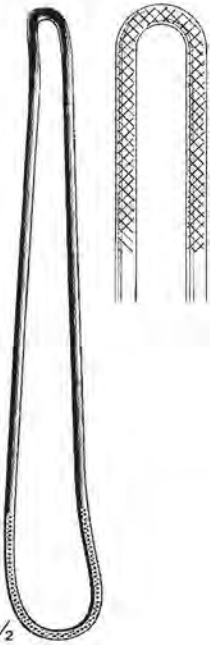

1/2  
 Frenzel  
 570-07-16  
 16.5 cm / 6 1/2"



1/2  
 Collin  
 570-08-16  
 16.5 cm / 6 1/2"



1/2  
 570-09-16  
 16.5 cm / 6 1/2"



Tobold  
 570-10-12  
 12 cm / 4 3/4"



1/2  
 Hartmann  
 570-11-15 15 cm / 6"  
 570-12-18 18 cm / 7"

**Mundsperrer  
Mouth Gag  
Ouvre-bouche**



$\frac{1}{2}$   
Baginski  
571-01-15  
15 cm / 6"



$\frac{1}{2}$   
Andrew  
571-02-11 11 cm / 4 $\frac{1}{4}$ "  
571-03-13 13 cm  $\frac{1}{5}$ "  
571-04-15 15 cm / 6"

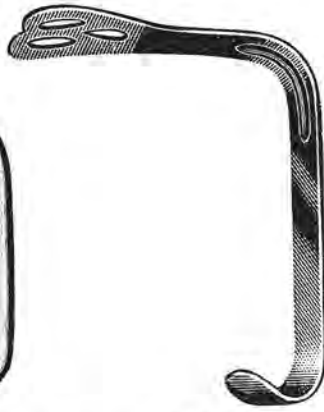

Weder  
571-05-14 & 571-06-15

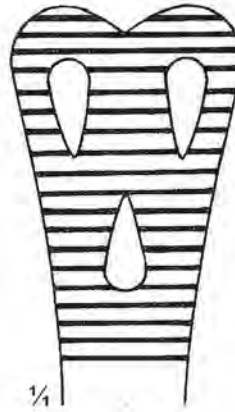

$\frac{1}{4}$   
571-05-14  
14 cm / 5 $\frac{1}{2}$ "  
28 mm

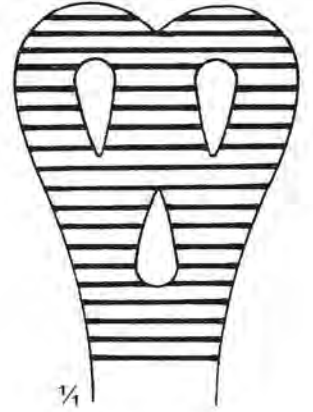

$\frac{1}{4}$   
571-06-15  
15 cm / 6"  
32 mm



$\frac{1}{2}$   
Bosworth  
571-07-12  
12 cm / 4 $\frac{3}{4}$ "

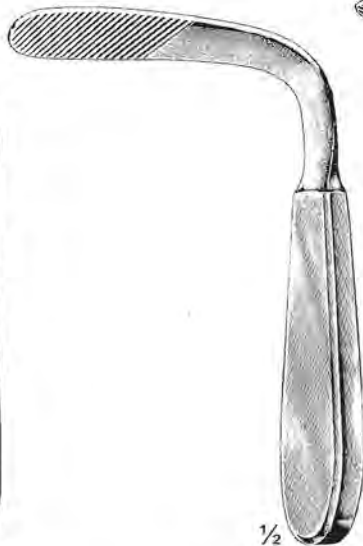

$\frac{1}{2}$   
Tobold  
571-08-14 14.5 cm / 5 $\frac{3}{4}$ "  
571-09-15 15 cm / 6"  
571-10-16 16.5 cm / 6 $\frac{1}{2}$ "

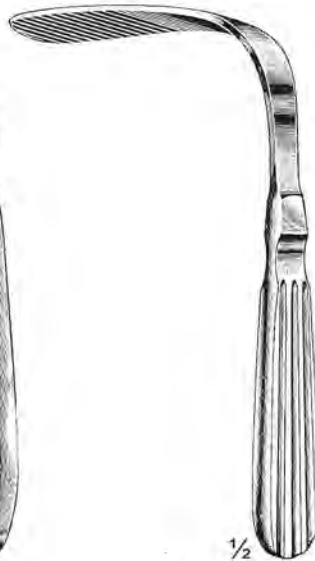

$\frac{1}{2}$   
Tobold  
571-11-14 14.5 cm / 5 $\frac{3}{4}$ "  
571-12-15 15 cm / 6"  
571-13-16 16.5 cm / 6 $\frac{1}{2}$ "

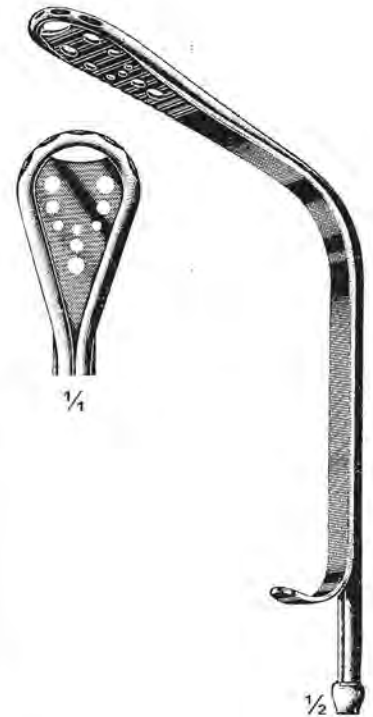

$\frac{1}{2}$   
Le Mee  
571-14-21  
21 cm / 8 $\frac{1}{4}$ "

**Lippen- u. WWangenhalter  
Lip and Cheek Retractors  
Ecarteurs des lèvres et joues**



**Mulux**  
**572-01-00**  
complete consisting :  
1 Battery handle  
1 Interchangeable wire depressor  
2 Wooden depressors  
2 Lenticular bulbs  
Packed in pouch



**University of Minnesota**  
**572-02-14**  
14 cm / 5½"



**Bishop**  
**572-03-13** 13 cm / 5¼"  
**572-04-15** 15 cm / 6"



**Tapia**  
**572-05-19**  
19 cm / 7½"



**Moritz-Schmidt**  
**572-06-19**  
19 cm / 7½"



**Sternberg**  
**572-07-12** 12 cm / 4¾"  
**572-08-14** 14 cm / 5½"  
**572-09-16** 16 cm / 6¼"  
**572-10-18** 18 cm / 7"

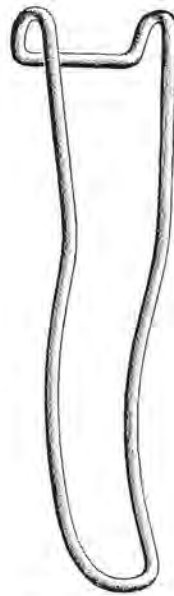

**Sternberg**  
**572-11-12** 12 cm / 4¾"  
**572-12-14** 14 cm / 5½"  
**572-13-16** 16 cm / 6¼"  
**572-14-18** 18 cm / 7"



**572-15-19**  
19 cm / 7½"



**572-16-21**  
21 cm / 8¼"

**Lippen- u WWangenhalter  
Lip and Cheek Retractors  
Ecarteurs des lèvres et joues**



$\frac{1}{2}$   
**573-01-11**  
11 cm / 4 $\frac{1}{4}$ "



$\frac{1}{2}$   
**Shuman**  
**573-02-19**  
19 cm / 7 $\frac{1}{2}$ "



$\frac{1}{4}$   
 $\frac{1}{2}$   
**Hartmann**  
**573-03-10**  
10 cm / 4"



$\frac{1}{4}$   
 $\frac{1}{2}$   
**Hartmann**  
**573-04-09**  
9 cm / 3 $\frac{1}{2}$ "



$\frac{1}{2}$   
**573-05-05**  
5 cm / 2"



$\frac{1}{2}$   
**573-06-07**  
7 cm / 3"

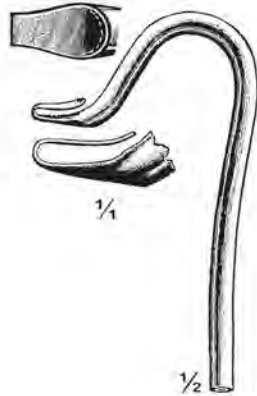

$\frac{1}{4}$   
 $\frac{1}{2}$   
**573-07-10**  
10 cm / 4"



$\frac{1}{2}$   
**Langenbeck**  
**573-08-00**



$\frac{1}{2}$   
**Langenbeck**  
**573-09-00**



$\frac{1}{2}$   
**Langenbeck**  
**573-10-00**

Intraorale Retraktoren  
 Intra Oral Retractors  
 Rétracteurs intra-oraux

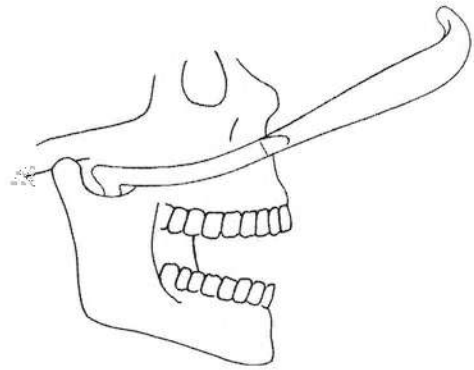
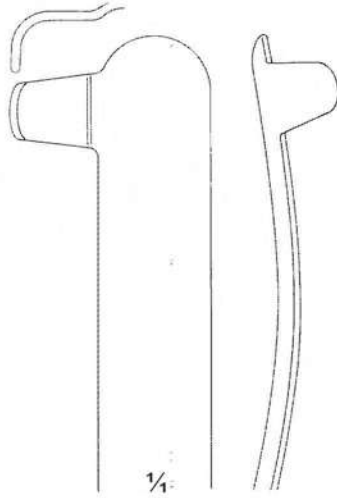
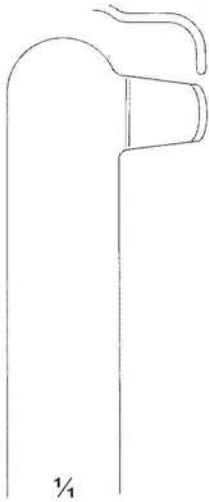

**574-01-21**  
 21.5 cm / 8½"  
 Right



**574-02-21**  
 21.5 cm / 8½"  
 Left



**574-03-21**  
 21.5 cm / 8½"  
 Right  
 With fiber optic



**574-04-21**  
 21.5 cm / 8½"  
 Left  
 With fiber optic

Intraorale Retraktoren  
 Intra Oral Retractors  
 Rétracteurs intra-oraux

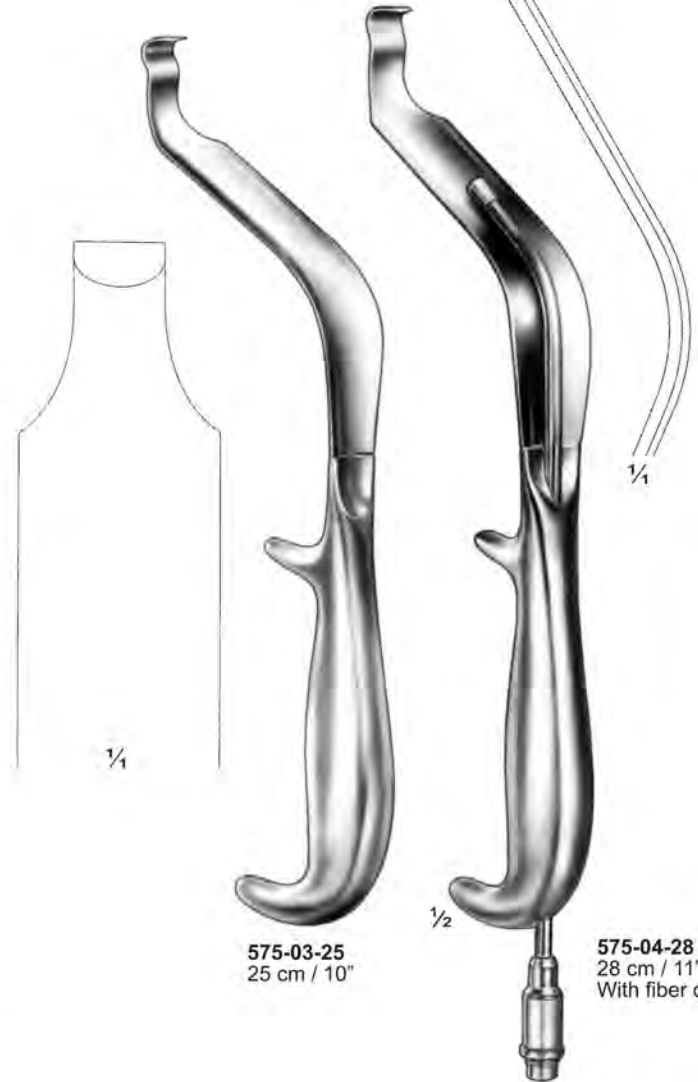
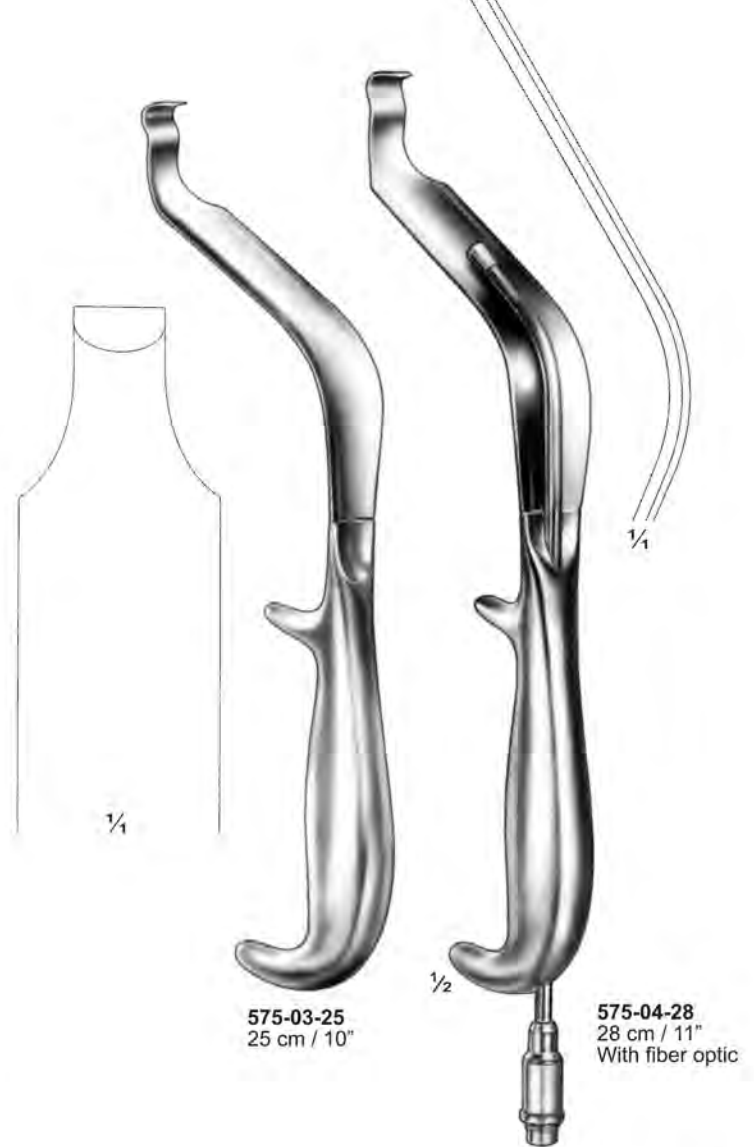
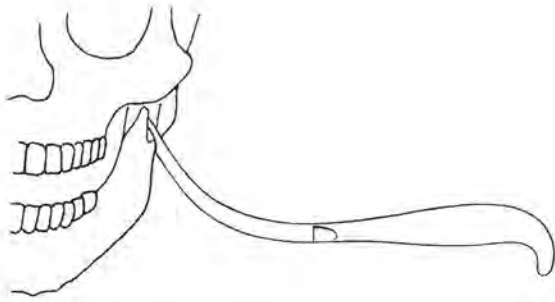



**Intraorale Retraktoren  
Intra Oral Retractors  
Rétracteurs intra-oraux**

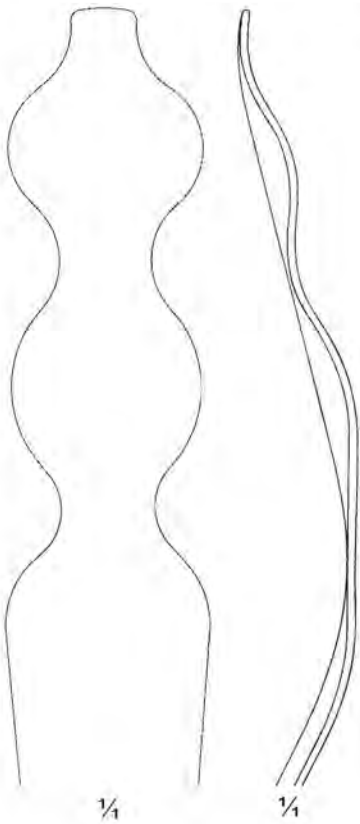
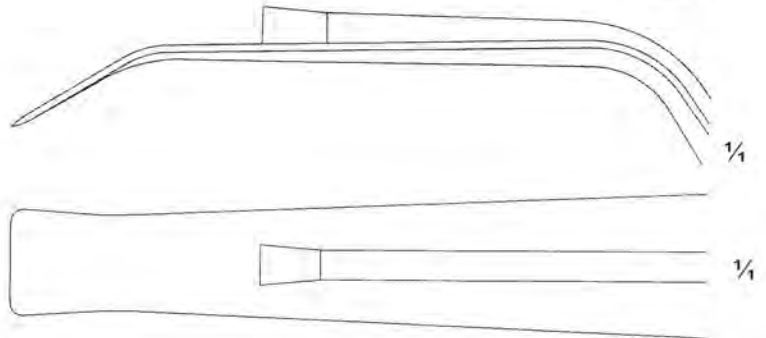
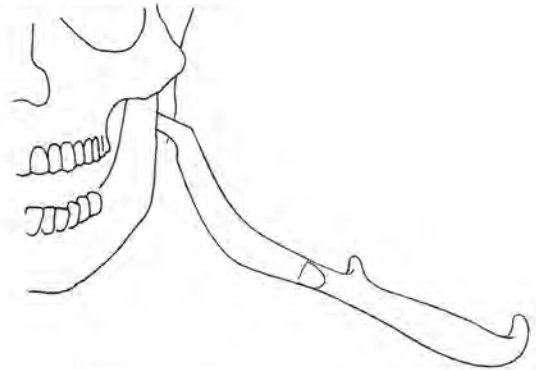
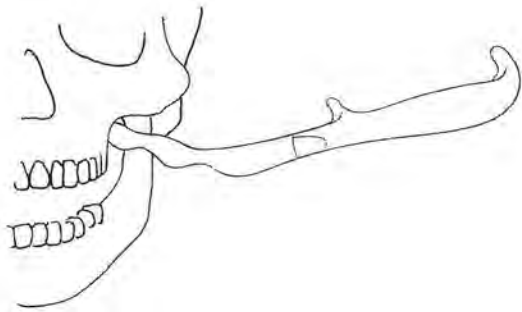

1/2  
**576-01-24**  
24 cm / 9 1/2"



1/2  
**576-02-27**  
27 cm / 10 1/2"  
With fiber optic



1/2  
**576-03-24**  
24 cm / 9 1/2"  
With fiber optic

**Ramushaken  
Ranis Retractors  
Ecarteurs pour ramus**

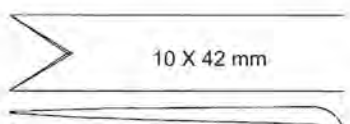

Obwegeser  
577-01-22  
22 cm / 8 3/4"

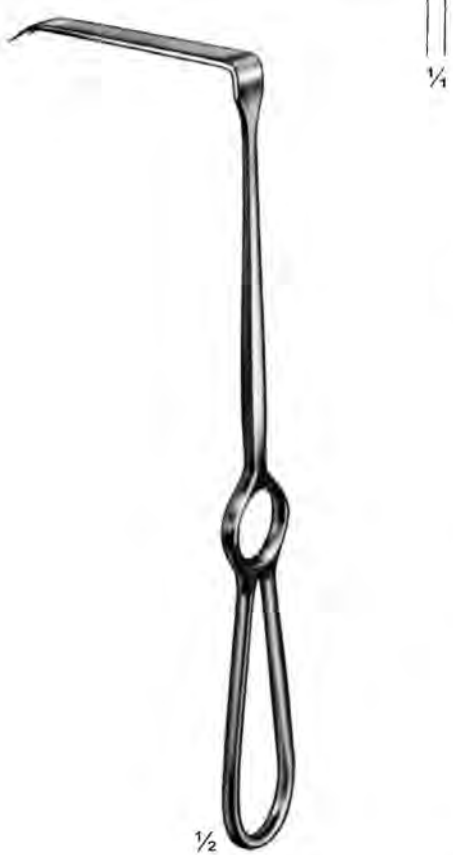
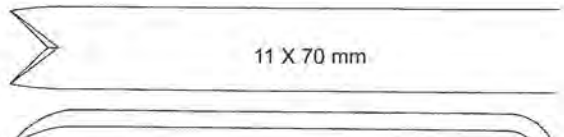

Obwegeser  
577-02-22  
22 cm / 8 3/4"

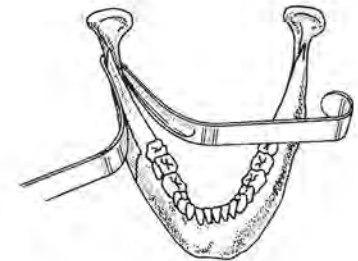

Obwegeser  
577-03-16  
16.5 cm / 6 1/2"



Obwegeser  
577-04-08 8 mm  
577-05-10 10 mm  
16.5 cm / 6 1/2"

Zungenzangen  
Tongue Holding Forceps  
Pincès tire-langue



1/4  
578-01-17  
578-07-17  
578-13-17  
17 cm / 6 3/4"



1/4  
578-02-17  
578-08-17  
578-14-17  
17 cm / 6 3/4"



1/4  
578-03-16  
578-09-16  
578-15-16  
16 cm / 6 1/4"



1/2

Collin  
578-01-17 To 578-06-19



1/2

Collin  
578-07-17 To 578-12-19



1/4  
578-05-17  
578-11-17  
578-17-17  
17 cm / 6 3/4"

578-06-19  
578-12-19  
578-18-19  
19 cm / 7 1/2"



1/2

Collin  
578-14-17 To 578-18-19



1/2

Guy  
578-19-19 & 578-20-19  
19 cm / 7 1/2"



1/4  
578-19-19  
578-21-19



1/4  
578-20-19  
578-22-19



1/2

Guy  
578-21-19 & 578-22-19  
19 cm / 7 1/2"

**Zungenzangen  
Tongue Holding Forceps  
Pincés tire-langue**



$\frac{1}{2}$   
**Loebker**  
**579-01-15**  
15 cm / 6"



$\frac{1}{2}$   
**Stille**  
**579-02-16**  
16 cm / 6 $\frac{1}{4}$ "



$\frac{1}{2}$   
**Young**  
**579-03-16**  
16.5 cm / 6 $\frac{1}{2}$ "

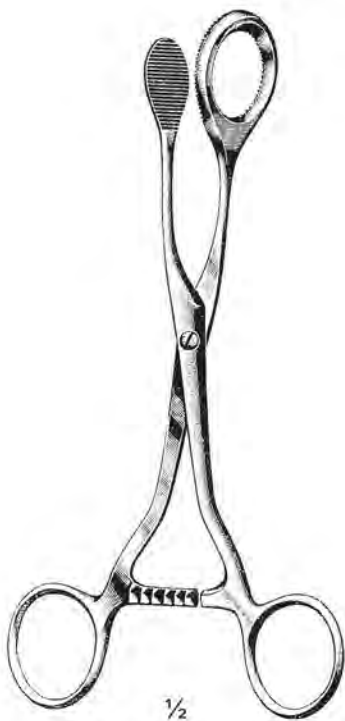

$\frac{1}{2}$   
**Mathieu**  
**579-04-19**  
19 cm / 7 $\frac{1}{2}$ "

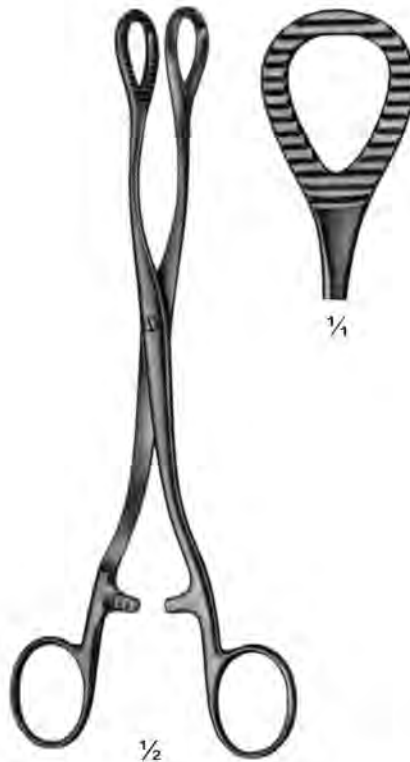

$\frac{1}{2}$   
**Heywood-Smith**  
**579-05-20**  
20 cm / 8"

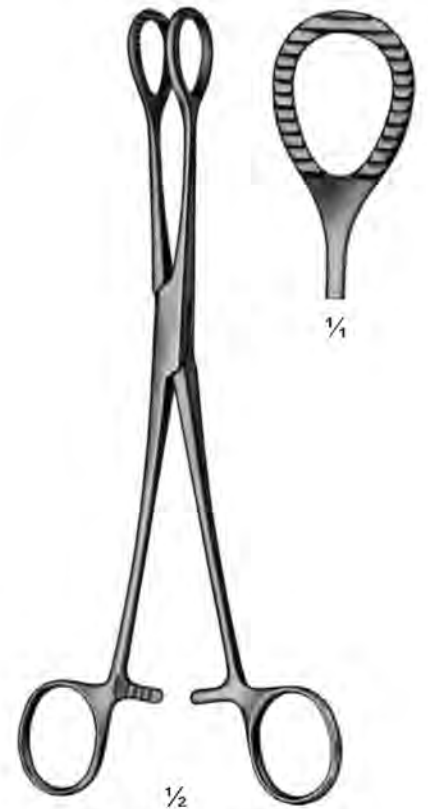

$\frac{1}{2}$   
**Heywood-Smith Modif.**  
**579-06-21**  
21.5 cm / 8 $\frac{1}{2}$ "

**Kehlkopfspiegel  
Laryngeal Mirrors  
Miroirs Laryngiens**



Fig. 000  
6 mm Ø



Fig. 00  
8 mm Ø

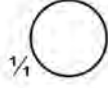

Fig. 0  
10 mm Ø

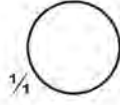

Fig. 1  
12 mm Ø

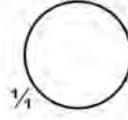

Fig. 2  
14 mm Ø

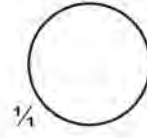

Fig. 3  
16 mm Ø

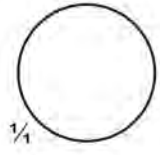

Fig. 4  
18 mm Ø

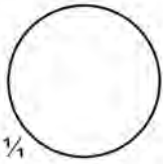

Fig. 5  
20 mm Ø

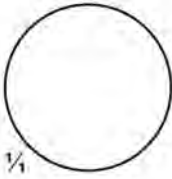

Fig. 6  
22 mm Ø

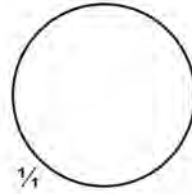

Fig. 7  
24 mm Ø

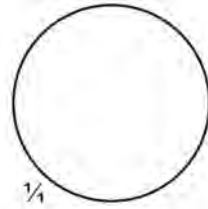

Fig. 8  
26 mm Ø

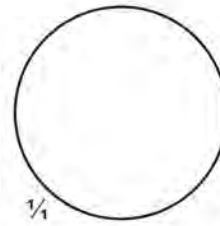

Fig. 9  
28 mm Ø

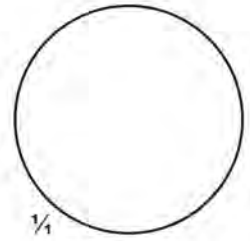

Fig. 10  
30 mm Ø



1/4



1/4



1/2



1/2



1/2



1/2

Plain		Magnifying	
580-01-06	Fig. 00	6 mm Ø	580-14-06
580-02-08	Fig. 0	8 mm Ø	580-15-08
580-03-10	Fig. 1	10 mm Ø	580-16-10
580-04-12	Fig. 2	12 mm Ø	580-17-12
580-05-14	Fig. 3	14 mm Ø	580-18-14
580-06-16	Fig. 4	16 mm Ø	580-19-16
580-07-18	Fig. 5	18 mm Ø	580-20-18
580-08-20	Fig. 6	20 mm Ø	580-21-20
580-09-22	Fig. 7	22 mm Ø	580-22-22
580-10-24	Fig. 8	24 mm Ø	580-23-24
580-11-26	Fig. 9	26 mm Ø	580-24-26
580-12-28	Fig. 10	28 mm Ø	580-25-28
580-13-30	Fig. 11	30 mm Ø	580-26-30

Plain		Magnifying	
580-27-06	Fig. 00	6 mm Ø	580-40-06
580-28-08	Fig. 0	8 mm Ø	580-41-08
580-29-10	Fig. 1	10 mm Ø	580-42-10
580-30-12	Fig. 2	12 mm Ø	580-43-12
580-31-14	Fig. 3	14 mm Ø	580-44-14
580-32-16	Fig. 4	16 mm Ø	580-45-16
580-33-18	Fig. 5	18 mm Ø	580-46-18
580-34-20	Fig. 6	20 mm Ø	580-47-20
580-35-22	Fig. 7	22 mm Ø	580-48-22
580-36-24	Fig. 8	24 mm Ø	580-49-24
580-37-26	Fig. 9	26 mm Ø	580-50-26
580-38-28	Fig. 10	28 mm Ø	580-51-28
580-39-30	Fig. 11	30 mm Ø	580-52-30
12 cm / 4 3/4"		12 cm / 4 3/4"	

580-53-07  
7 cm / 2 3/4"

580-54-11  
11 cm / 4 1/4"

**Kehlkopfspiegel  
Laryngeal Mirrors  
Miroirs Laryngiens**

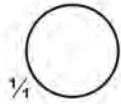

$\frac{1}{4}$   
**581-06-12**  
Fig. 2  
12 mm Ø

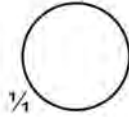

$\frac{1}{4}$   
**581-07-14**  
Fig. 3  
14 mm Ø

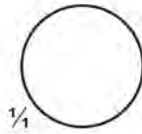

$\frac{1}{4}$   
**581-08-16**  
Fig. 4  
16 mm Ø

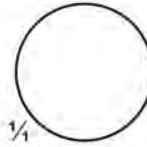

$\frac{1}{4}$   
**581-09-18**  
Fig. 5  
18 mm Ø



$\frac{1}{2}$   
Michel  
**581-06-12 To 581-09-18**  
25 cm / 10"



$\frac{1}{3}$   
Baxt  
**581-05-24**  
24 cm / 9½"



$\frac{1}{2}$   
**581-01-11**  
11 cm / 4¼"



$\frac{1}{2}$   
**581-02-10**  
10.5 cm / 4¼"

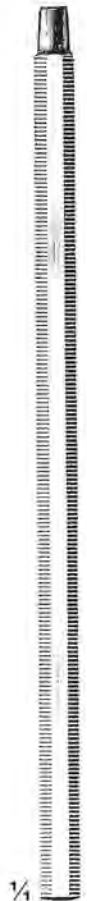

$\frac{1}{4}$   
**581-03-12**  
12 cm / 4¾"



$\frac{1}{4}$   
**581-04-13**  
13 cm / 5¼"

Laryngeal Zange  
Laryngeal Forceps  
Forceps Larynges

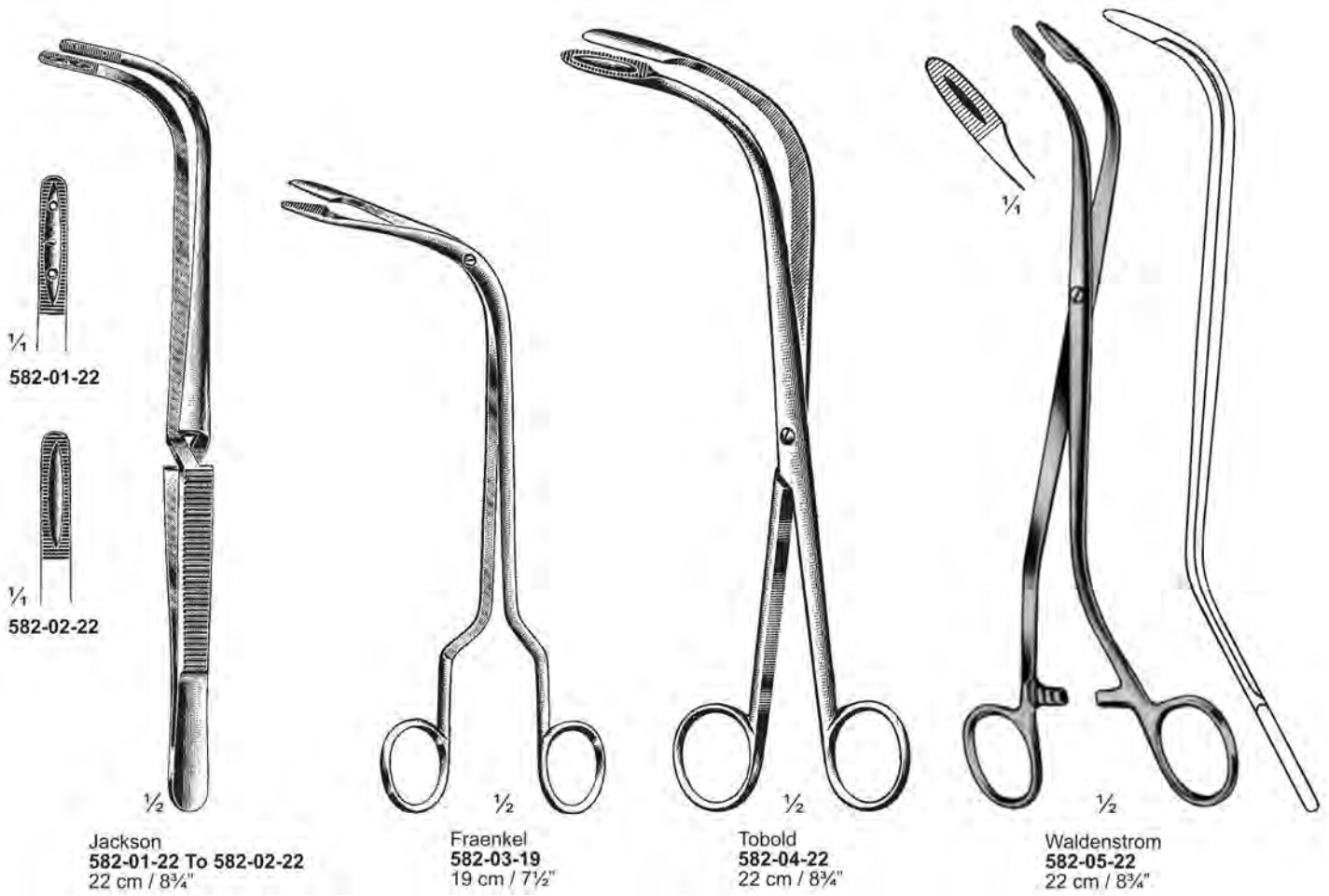

Laryngeal Zange  
Laryngeal Forceps  
Forceps Larynges

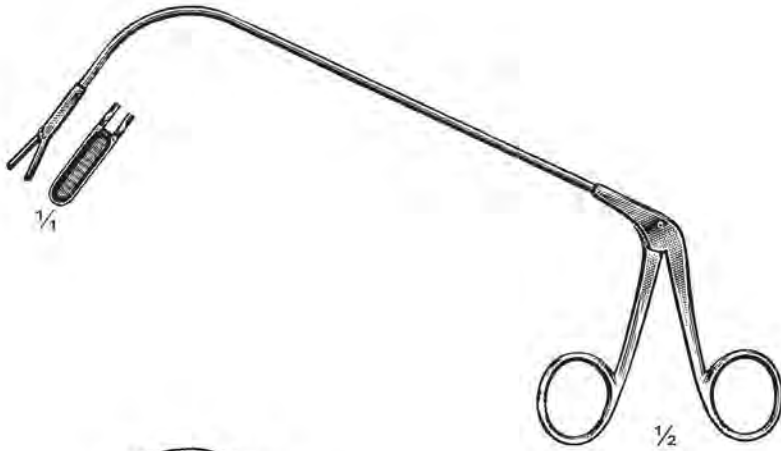

Fraenkel  
583-01-19  
19 cm / 7½"

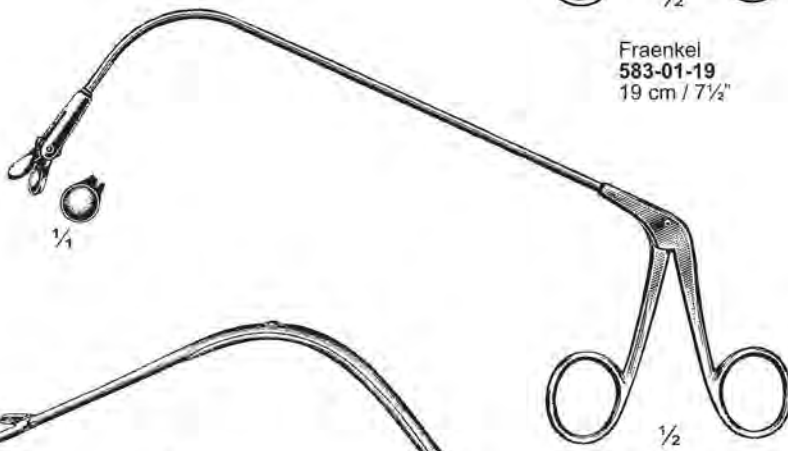

Lange  
583-02-19  
19 cm / 7½"

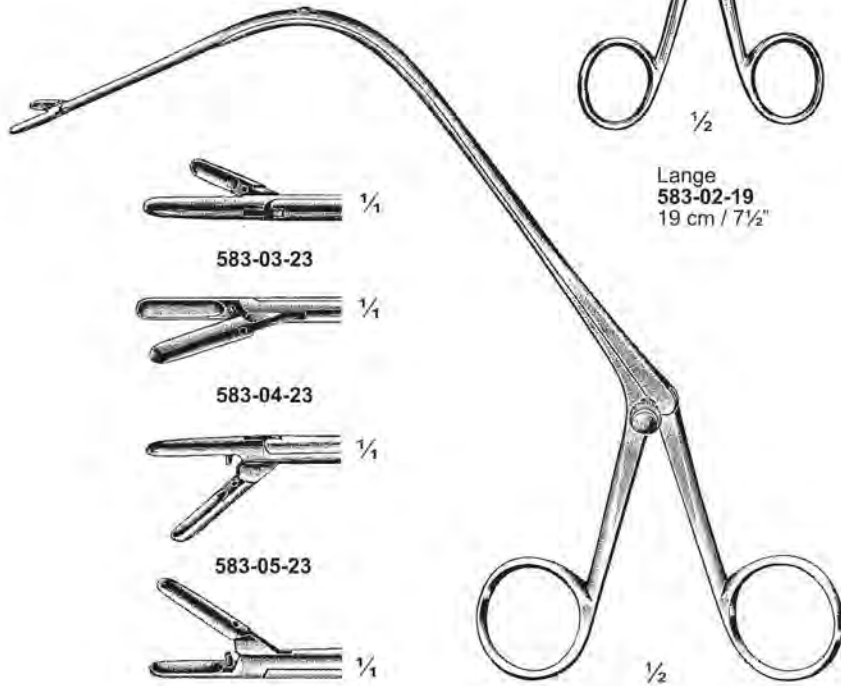

Jurasz  
583-03-23 To 583-06-23  
23 cm / 9"



583-03-23



583-04-23



583-05-23



583-06-23



Reichert  
583-07-24  
24 cm / 9½"

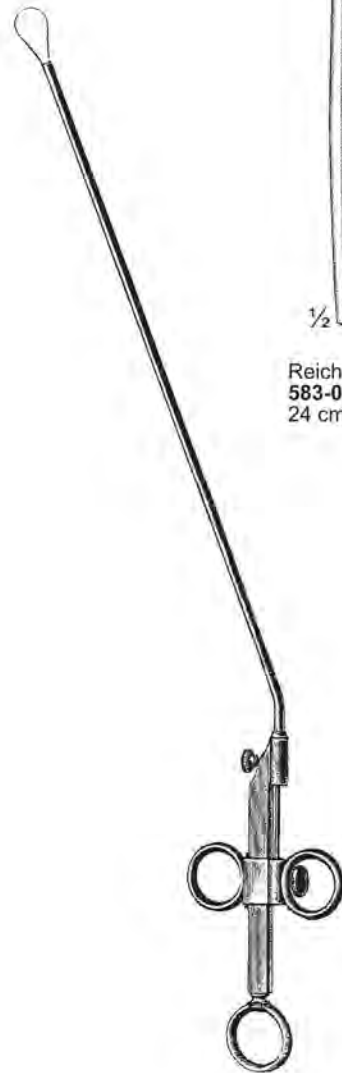

583-08-24  
24 cm / 9½"



**Mobilisierhaken  
Temporomandibular Instruments  
Crochet de mobilisation**

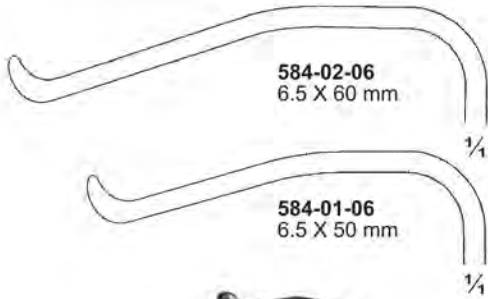

**584-02-06**  
6.5 X 60 mm

**584-01-06**  
6.5 X 50 mm



$\frac{1}{2}$   
Dunn-Dautrey  
**584-01-06 & 584-02-06**  
15 cm / 6"



8 X 50 mm

6.5 X 50 mm

$\frac{1}{2}$   
Dunn-Dautrey  
**584-03-15**  
15 cm / 6"

$\frac{1}{2}$   
Dunn-Dautrey  
**584-04-15**  
15 cm / 6"



$\frac{1}{2}$   
Dunn-Dautrey  
**584-05-13**  
13.5 cm / 5 1/4"



$\frac{1}{2}$   
Dunn-Dautrey  
**584-06-06 & 484-07-06**  
15 cm / 6"

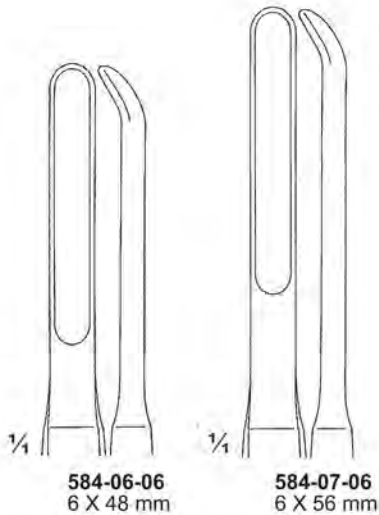

**584-06-06**  
6 X 48 mm

**584-07-06**  
6 X 56 mm

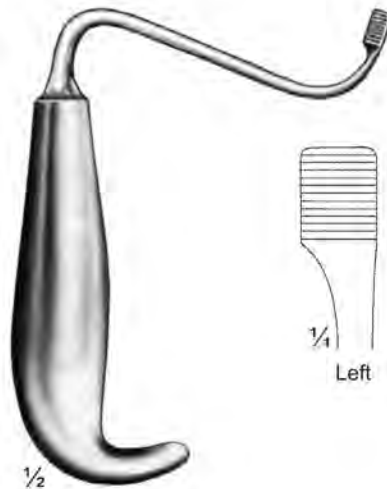

$\frac{1}{2}$   
Tessier  
**584-08-00**



$\frac{1}{4}$   
Left

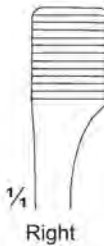

$\frac{1}{4}$   
Right

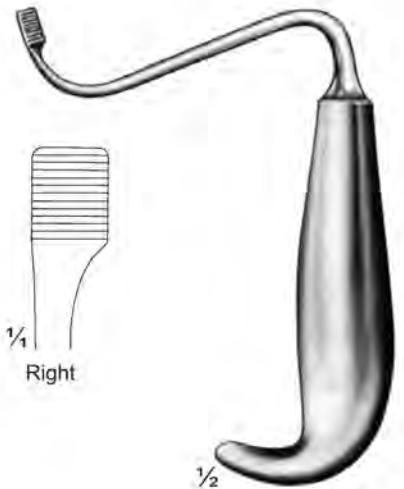

$\frac{1}{2}$   
Tessier  
**584-09-00**

Repositionszangen  
Disimpaction Forceps  
Pincès de reposition

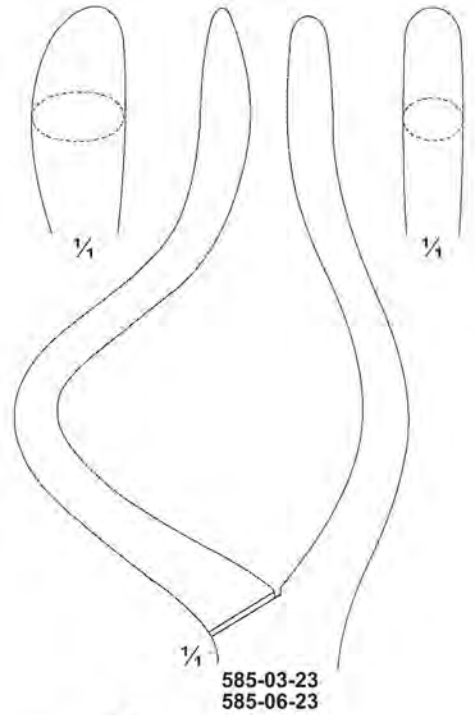
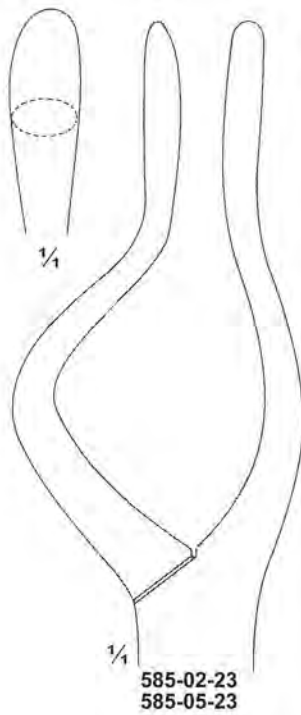
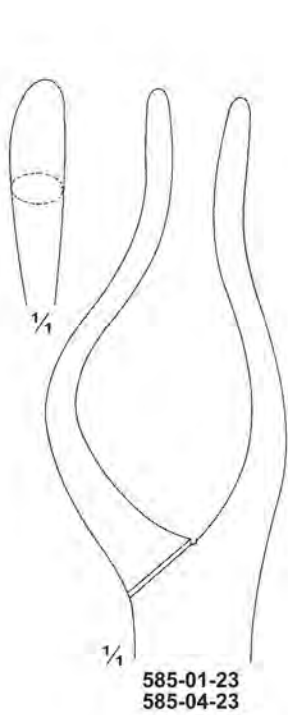

Rowe  
585-01-23 To 585-03-23  
23 cm / 9"  
Left



Rowe  
585-04-23 To 585-06-23  
23 cm / 9"  
Right

**Unterkieferahlen  
Maxillary Awls  
Alènes maxillaires**

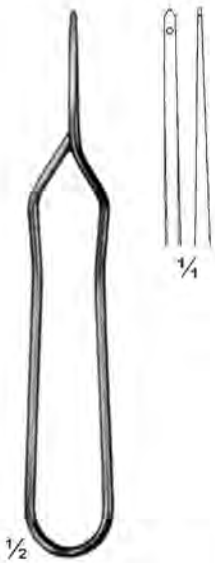

Kelsey-Fry  
586-01-15  
15 cm / 6"

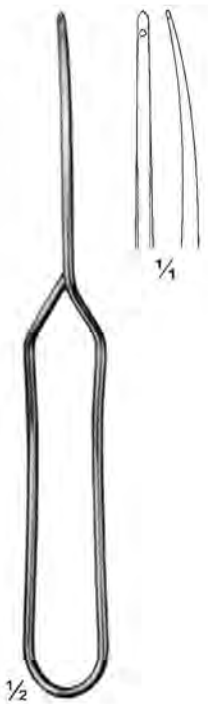

Kelsey-Fry  
586-02-18  
18 cm / 7"



Obwegesser  
586-03-18 18 cm / 7"  
586-04-28 28 cm / 11"



Obwegesser  
586-05-13  
13 cm / 5 "



Obwegesser  
586-06-23  
23 cm / 9"



Sanders-Brown  
586-07-29  
29 cm / 11 1/2"



Sanders-Brown  
586-08-30  
30 cm / 12"

**Tonsillenmesser  
Tonsil Knife  
Bistouri éténucléateur pour**



Lynch  
587-01-20  
20 cm / 8"



Lothrop  
587-02-20  
20 cm / 8"



$\frac{1}{2}$   
587-03-18  
18 cm / 7"



587-04-18  
18 cm / 7"



$\frac{1}{4}$



$\frac{1}{2}$   
Abraham  
587-05-21  
21 cm / 8 $\frac{1}{4}$ "



$\frac{1}{4}$



Bruenings  
587-06-23  
23 cm / 9"

$\frac{1}{4}$



Canfield  
587-07-21  
21 cm / 8 $\frac{1}{4}$ "

$\frac{1}{4}$



$\frac{1}{2}$   
Tyding  
587-08-21  
21 cm / 8 $\frac{1}{4}$ "



$\frac{1}{2}$   
Robb  
587-09-22  
22 cm / 8 $\frac{3}{4}$ "



$\frac{1}{4}$



$\frac{1}{4}$

**Tonsillenmesser  
Tonsil Knife  
Bistouri éténucléateur pour**



Robertson  
588-01-21  
21.5 cm / 8½"



Abraham  
588-02-20  
20 cm / 8"



Brophy  
588-03-19  
19 cm / 7½"



Freer  
588-04-21  
21 cm / 8¼"



Freer  
588-05-21  
21 cm / 8¼"



Day  
588-06-21  
21.5 cm / 8½"



Fischer  
588-07-23  
23 cm / 9"



Colver  
588-08-23  
23 cm / 9"



Douglas  
588-09-21  
21 cm / 8¼"

**Tonsillenmesser  
Tonsil Knife  
Bistouri éténucléateur pour**

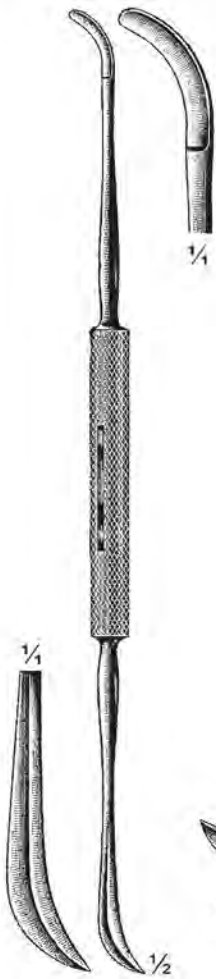

Harris  
589-01-26  
26 cm / 10 1/4"



Millette  
589-02-26  
26 cm / 10 1/4"

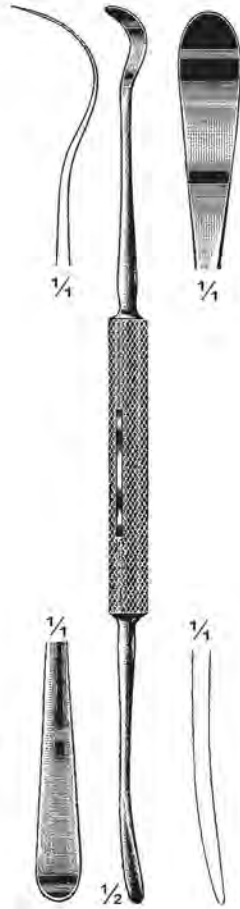

Carpenter  
589-03-24  
24 cm / 9 1/2"

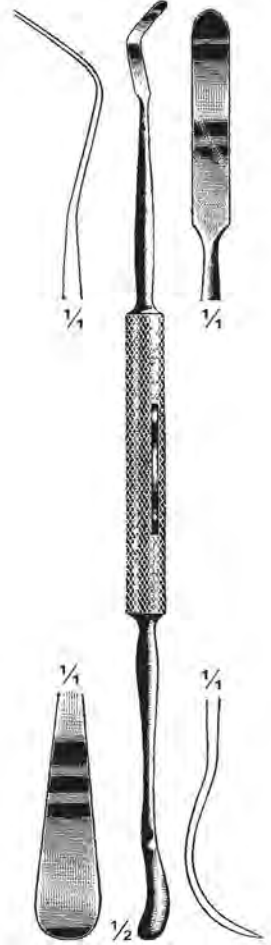

Carpenter  
589-04-25  
25 cm / 10"



Whitehead  
589-05-19  
19 cm / 7 1/2"



Whitehead  
589-06-19  
19 cm / 7 1/2"



Dean  
589-07-19 & 589-08-19  
19 cm / 7 1/2"

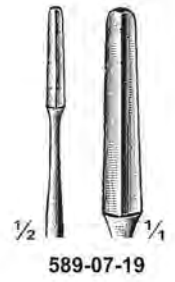

589-07-19

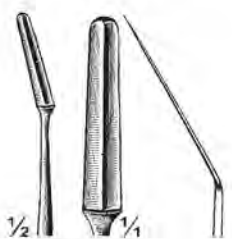

589-08-19

**Tonsillenelevator/ Retraktor, Tonsillenelevatorien  
Tonsil Dissector/Retractor, Tonsil Elevators  
Dissecteur/Rétracteur pour amygdales, Élévateurs pour amygdales**



Colver  
590-01-19  
19 cm / 7½"

¼



590-02-21 To 590-04-21  
21.5 cm / 8½"



½  
Kyle  
590-02-21



½  
Boettcher  
590-03-21



½  
Boettcher  
590-04-21



Hurd  
590-05-22 & 590-06-22  
22 cm / 8¾"

¼

½

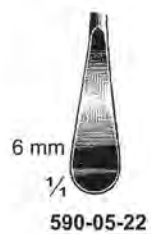

6 mm  
¼  
590-05-22



10 mm  
¼  
590-06-22



½  
Roeder  
590-07-26  
26.5 cm / 10½"



¼

¼

¼

½  
Henke  
590-08-23  
23 cm / 9"



¼

¼

¼

½  
Henke  
590-09-23  
23 cm / 9"

**Tonsillenelevator/ Retraktor, Tonsillenelevatorien  
Tonsil Dissector/Retractor, Tonsil Elevators  
Dissecteur/Rétracteur pour amygdales, Élévateurs pour amygdales**

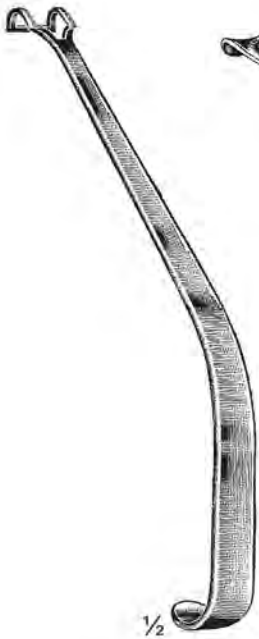

1/2

**Robb-Lewis**  
**591-01-16**  
16 cm / 6 1/4"

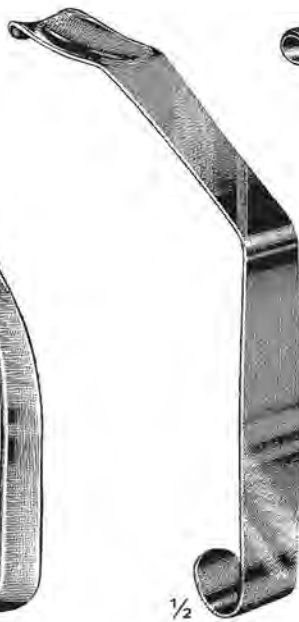

1/2

**Love**  
**591-02-18** 18 mm  
**591-03-20** 20 mm  
**591-04-22** 22 mm  
15 cm / 6"



1/2

**Goodyear**  
**591-05-16**  
16 cm / 6 1/4"

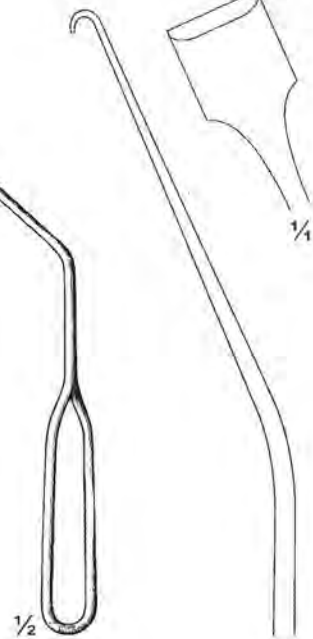

1/2

**Lothrop**  
**591-06-17**  
17 cm / 6 3/4"



1/2

**Nager**  
**591-07-24**  
24 cm / 9 1/2"

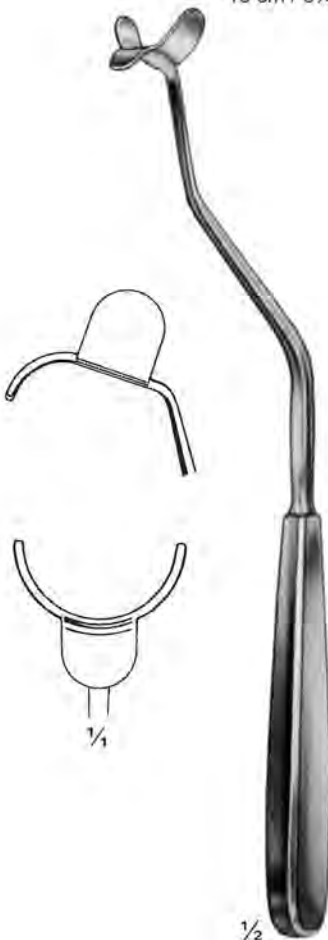

1/2

**Hofer**  
**591-08-24**  
24 cm / 9 1/2"



1/2

**Wieder**  
**591-09-21**  
21.5 cm / 8 1/2"

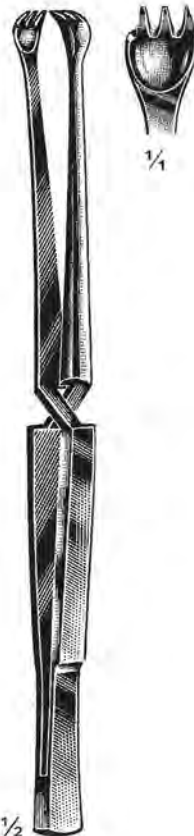

1/2

**Marschik**  
**591-10-22**  
22 cm / 8 3/4"



1/2

**Lewis**  
**591-11-19 & 591-12-19**  
19.5 cm / 7 3/4"



1/4

**591-11-19**



1/4

**591-12-19**

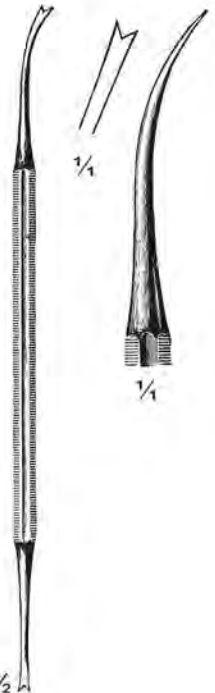

1/2

**Luniatzschek**  
**591-13-19**  
19 cm / 7 1/2"



Tonsillenelevator/ Retraktor, Tonsillenelevatorien  
 Tonsil Dissector/Retractor, Tonsil Elevators  
 Dissecteur/Rétracteur pour amygdales, Élévateurs pour amygdales



1/2  
 Yankauer  
 592-01-21  
 21 cm / 8 1/4"

1/4  
 Alderdice  
 592-02-22  
 22 cm / 8 1/4"

Hartmann  
 592-03-23  
 23 cm / 9"

1/4  
 Nager  
 592-04-24  
 24 cm / 9 1/2"

1/2  
 Dupuy-Weiss  
 592-05-22  
 22 cm / 8 3/4"

1/2  
 Dupuy-Weiss  
 592-06-22  
 22 cm / 8 3/4"

1/2  
 Henton  
 592-07-18  
 18 cm / 7"

1/2  
 Henton  
 592-08-19  
 19 cm / 7 1/2"

1/2  
 Henton  
 592-09-19  
 19 cm / 7 1/2"

1/2  
 Henton  
 592-10-20  
 20 cm / 8"

1/2  
 Trelat  
 592-11-23  
 23 cm / 9"

**Tonsillenkanüle  
Tonsil Needles  
Aiguille pour amygdales**

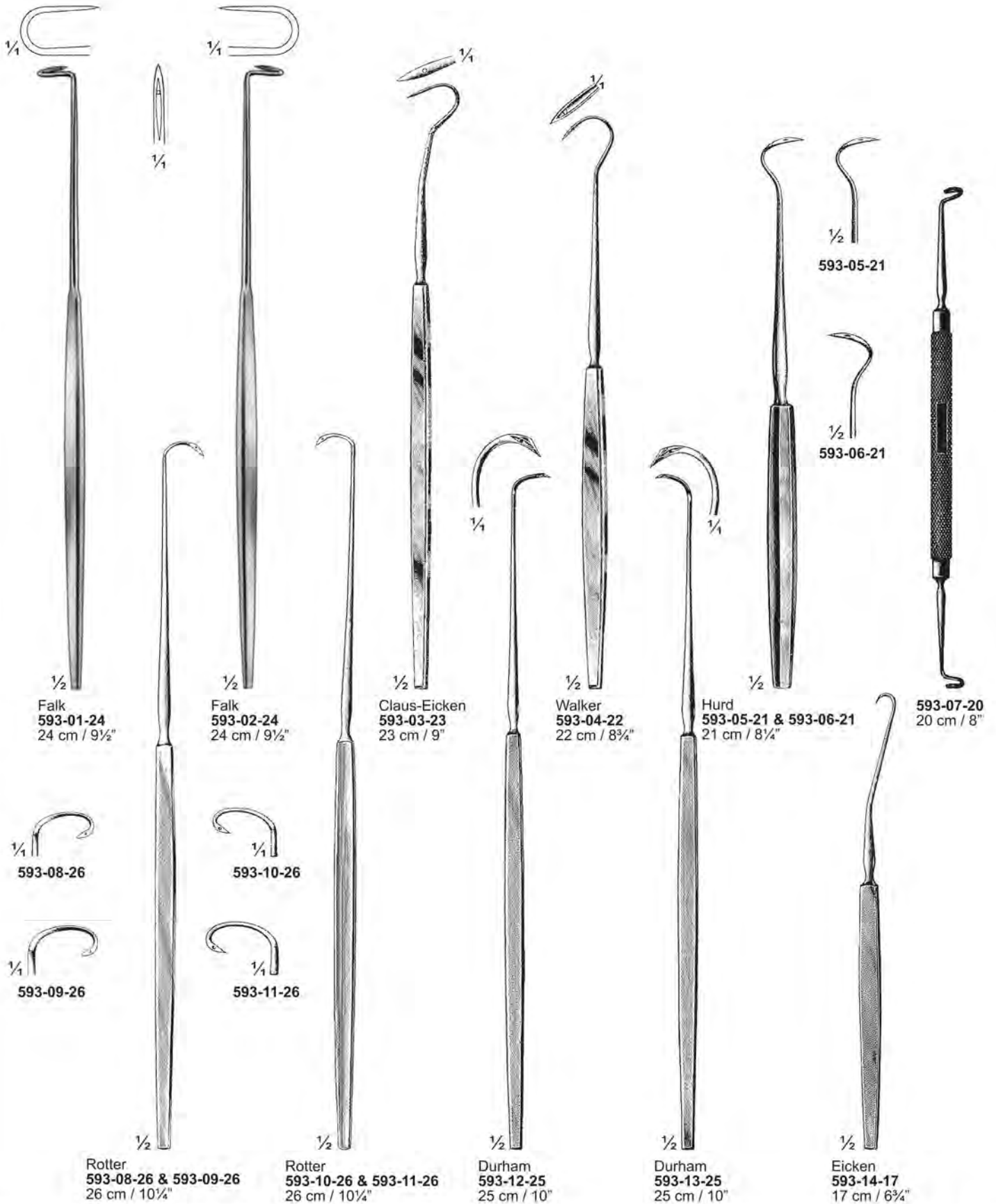

$\frac{1}{2}$   
Falk  
593-01-24  
24 cm / 9½"

$\frac{1}{2}$   
Falk  
593-02-24  
24 cm / 9½"

$\frac{1}{2}$   
Claus-Eicken  
593-03-23  
23 cm / 9"

$\frac{1}{2}$   
Walker  
593-04-22  
22 cm / 8¾"

$\frac{1}{2}$   
Hurd  
593-05-21 & 593-06-21  
21 cm / 8¼"

593-07-20  
20 cm / 8"

$\frac{1}{4}$   
593-08-26

$\frac{1}{4}$   
593-10-26

$\frac{1}{4}$   
593-09-26

$\frac{1}{4}$   
593-11-26

$\frac{1}{2}$   
Rotter  
593-08-26 & 593-09-26  
26 cm / 10¼"

$\frac{1}{2}$   
Rotter  
593-10-26 & 593-11-26  
26 cm / 10¼"

$\frac{1}{2}$   
Durham  
593-12-25  
25 cm / 10"

$\frac{1}{2}$   
Durham  
593-13-25  
25 cm / 10"

$\frac{1}{2}$   
Eicken  
593-14-17  
17 cm / 6¾"

**Tonsillenklemmen  
Tonsil Forceps  
Pincettes pour amygdales**

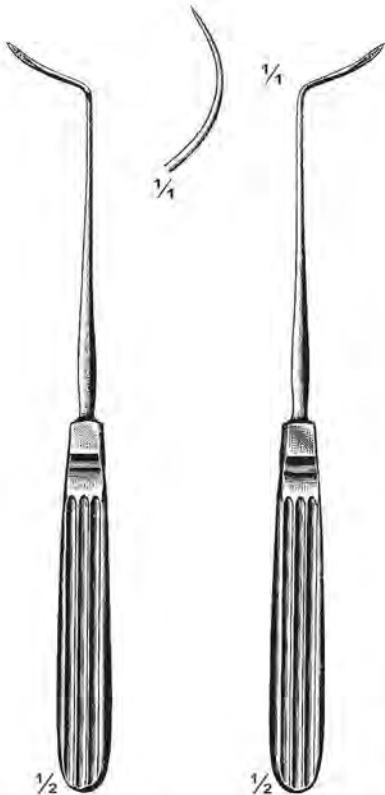

1/2  
Alexander  
594-01-20  
20 cm / 8"

1/2  
Alexander  
594-02-20  
20 cm / 8"



1/2  
Marschik-Krone  
594-03-20  
20 cm / 8"



1/2  
White  
594-04-18 18 cm / 7"  
594-05-23 23 cm / 9"

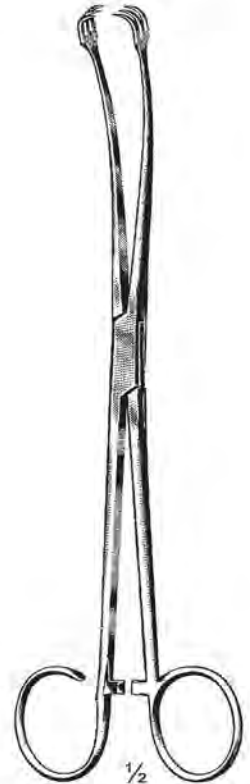

1/2  
Ballenger  
594-06-21  
21.5 cm / 8 1/2"

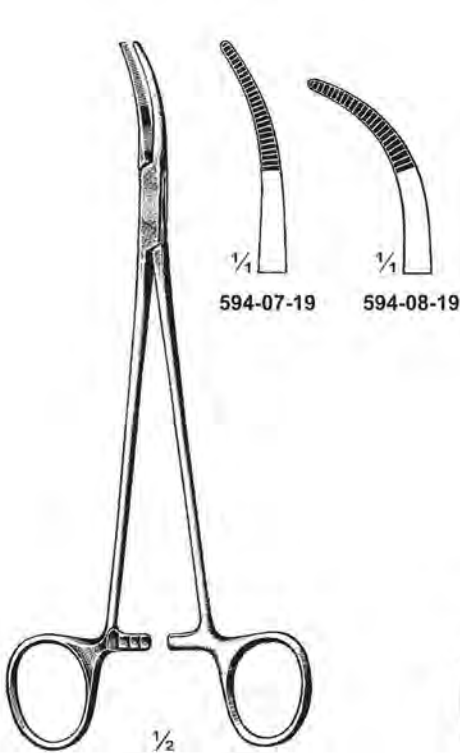

1/2  
Schnidt  
594-07-19 & 594-08-19  
19 cm / 7 1/2"

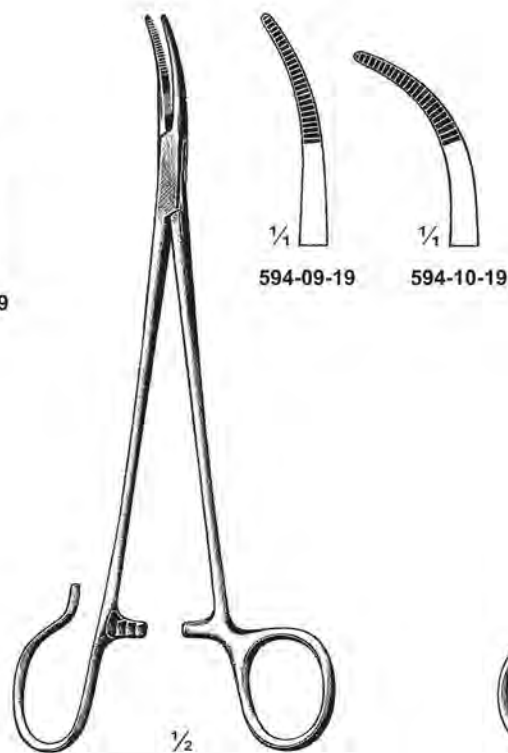

1/2  
Schnidt  
594-09-19 & 594-10-19  
19 cm / 7 1/2"

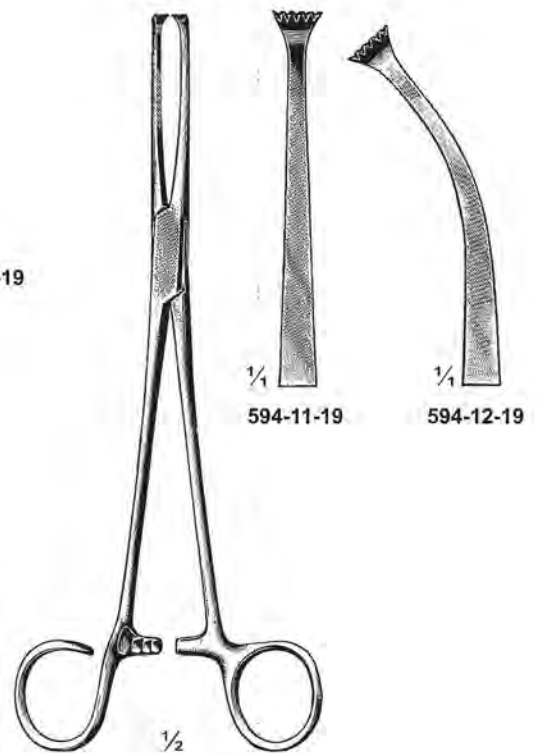

1/2  
Colver  
594-11-19 & 594-12-19  
19 cm / 7 1/2"

**Tonsillenklemmen**  
**Tonsil Forceps**  
**Pinces pour amygdales**



Muck  
595-01-08 & 595-02-10  
18 cm / 7"



595-03-20  
Museux  
595-03-20 & 595-04-20  
20 cm / 8"

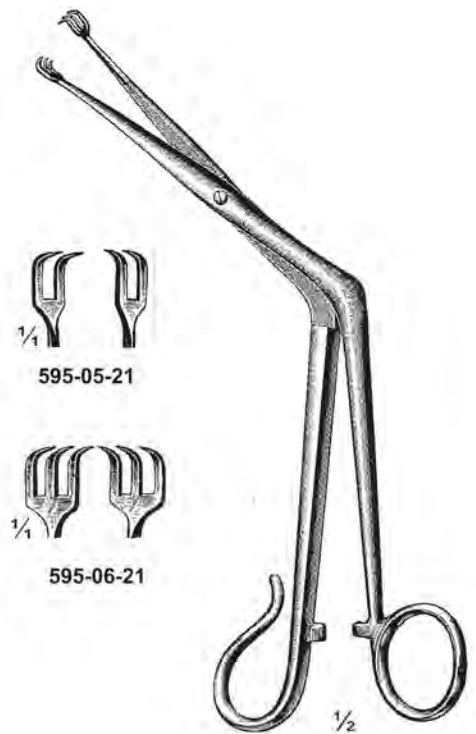

Tivnen-Tyding  
595-05-21 & 595-06-21  
21 cm / 8 1/4"

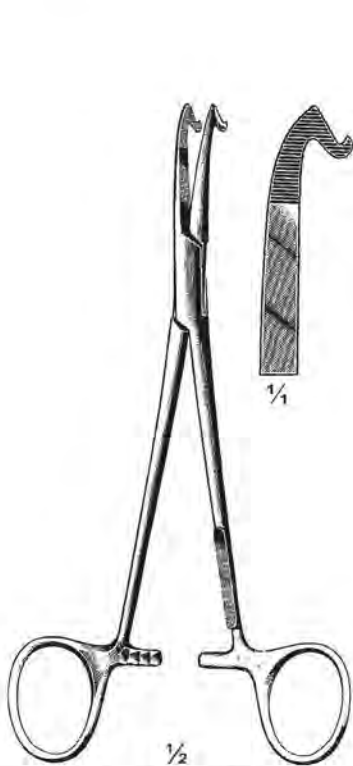

McWorther-Lothrop  
595-07-18  
18.5 cm / 7 1/4"



Blohmke  
595-08-20  
20 cm / 8"

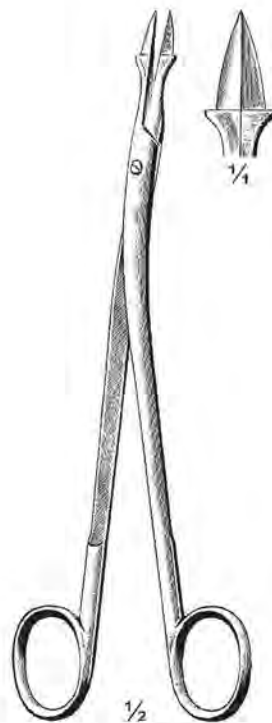

Thilenius  
595-09-20  
20 cm / 8"

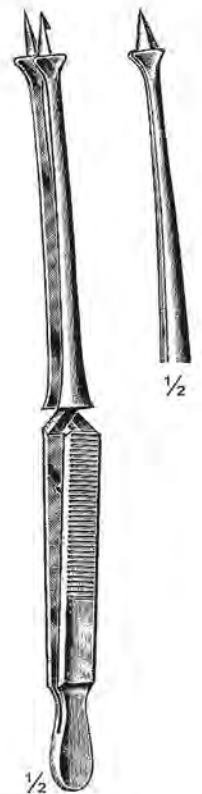

Leineweber  
595-10-20  
20 cm / 8"

**Tonsillenschnürer  
Tonsil Snares  
Serre-noeuds pour amygdales**

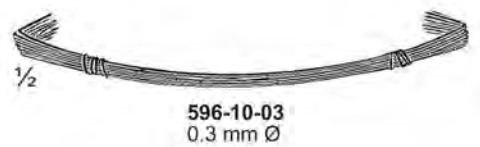
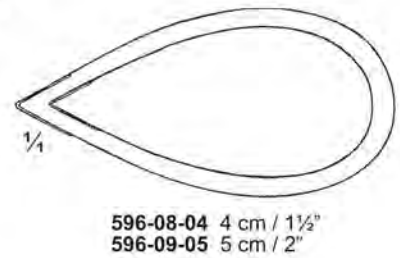
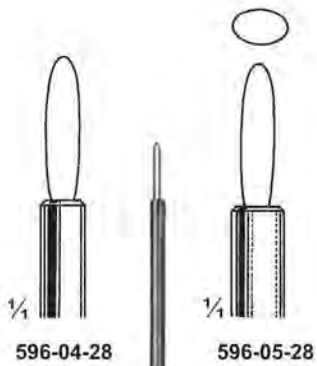
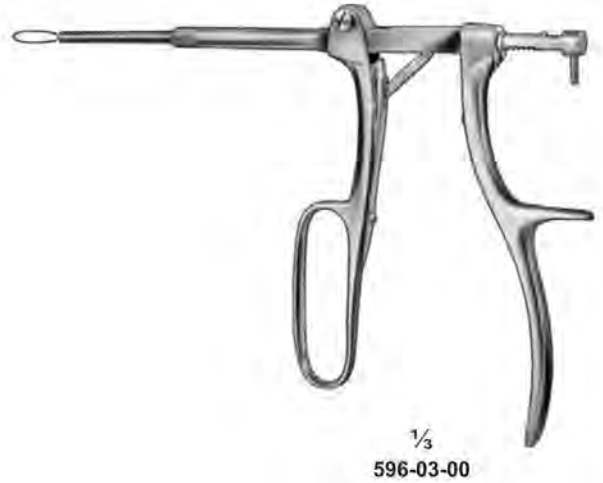
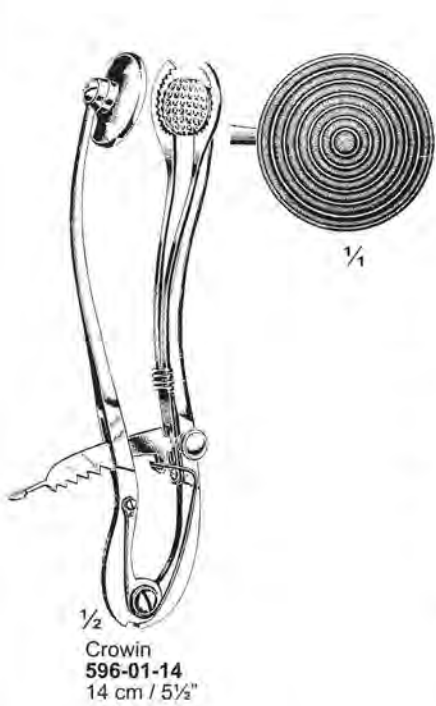

**Tonsillenschnürer, Tonsillenzangen**  
**Tonsil Snares, Tonsil Punches**  
**Serre-noeuds pour amygdales, Pincettes pour amygdales**

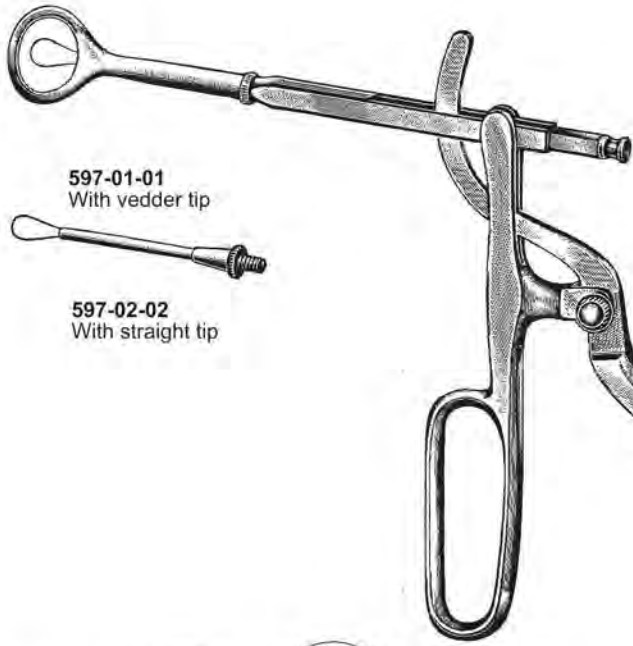

**597-01-01**  
With vedder tip



**597-02-02**  
With straight tip

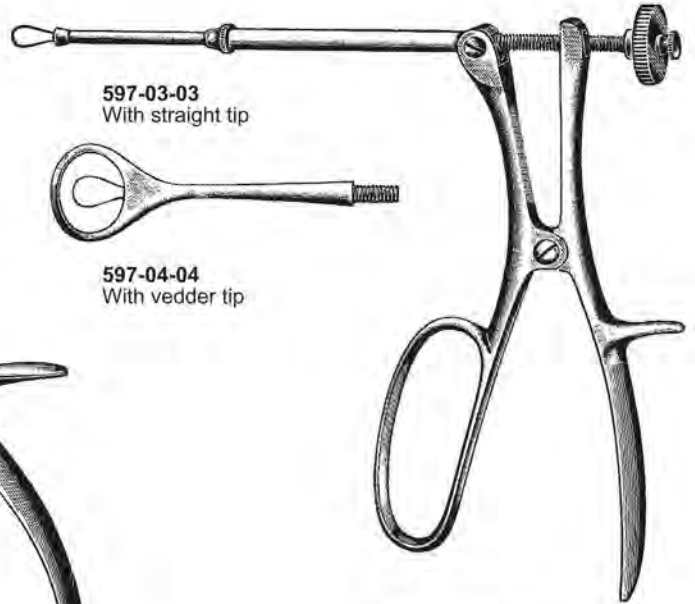

**597-03-03**  
With straight tip



**597-04-04**  
With vedder tip

Brown  
597-03-03 & 597-04-04

Tyding  
597-01-01 & 597-02-02

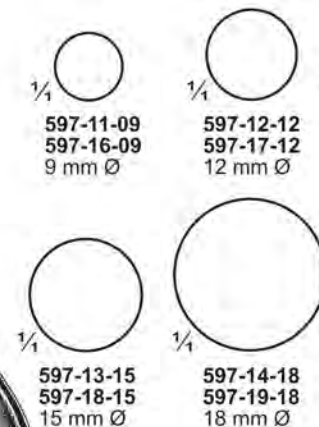
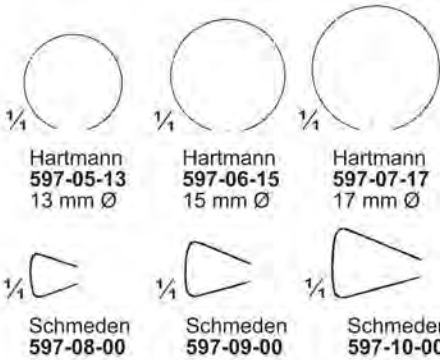

**597-05-13 To 597-10-00**  
21 cm / 8 $\frac{1}{4}$ "

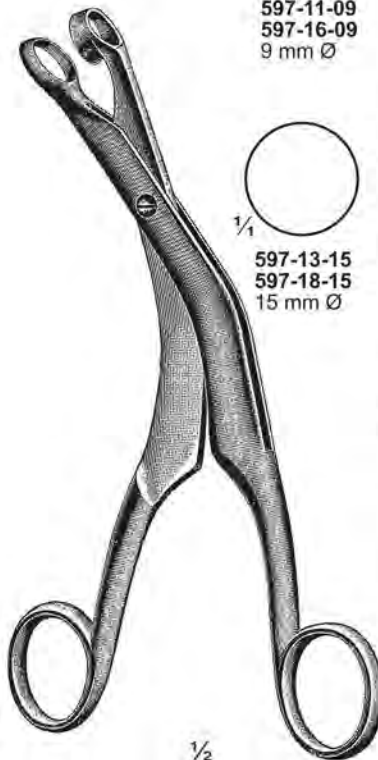

Ruault  
**597-11-09 To 597-15-20**  
21 cm / 8 $\frac{1}{4}$ "

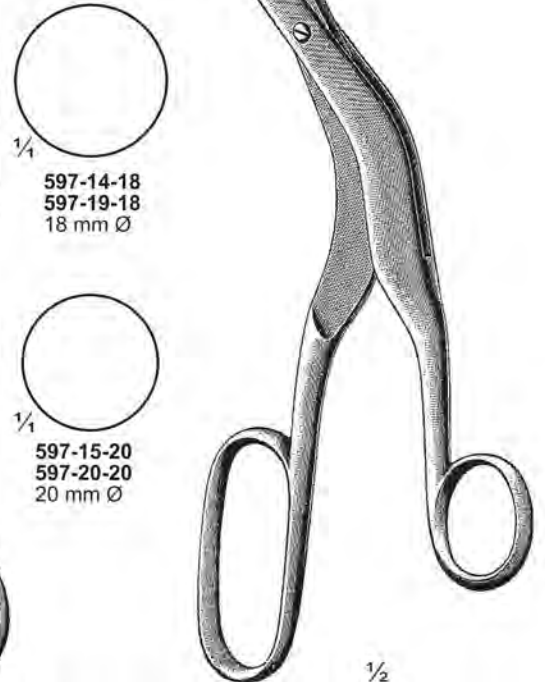

Ruault-Collin  
**597-16-09 To 597-20-20**  
22 cm / 8 $\frac{3}{4}$ "

**Tonsillenschnürer, Tonsillenzangen**  
**Tonsil Snares, Tonsil Punches**  
**Serre-noeuds pour amygdales, Pincés pour amygdales**



Sluder-Ballenger  
 598-01-01 To 598-03-03  
 598-04-03  
 Complete with 3 tips

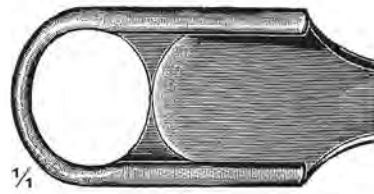

598-01-01  
 598-05-05

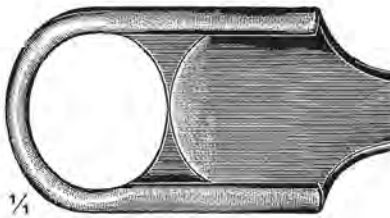

598-02-02  
 598-06-06



598-03-03  
 598-07-07



Sluder-Ballenger  
 598-05-05 To 598-07-07  
 598-08-03  
 Complete with 3 tips



1/2  
 Baginsky  
 598-09-24  
 24 cm / 9 1/2"

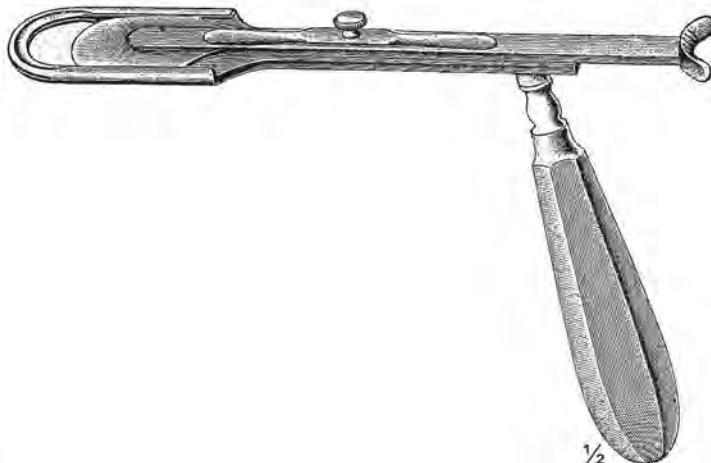

1/2  
 Mackenzie  
 598-10-00

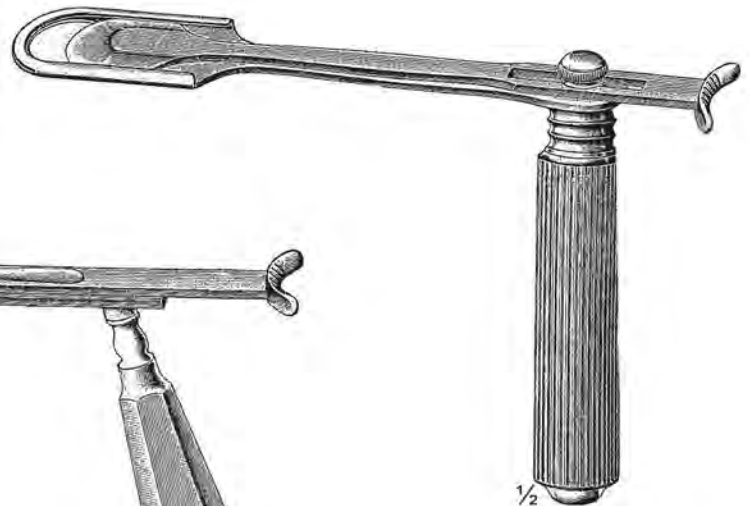

1/2  
 Mackenzie  
 598-11-00

**Broncho-Oesophagoskopiezangen**  
**Broncho-Esophagoscapy Forceps**  
**Pinces Pour Broncho-Esophagoscopie**

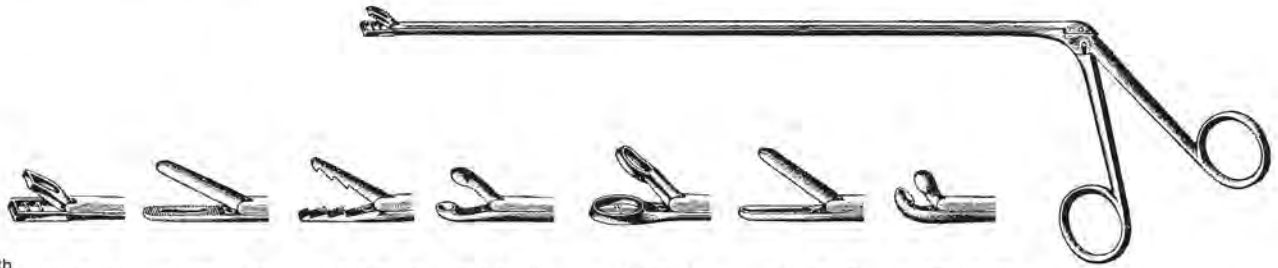

Shaft length  
 30 cm / 12"  
 40 cm / 16"  
 50 cm / 20"  
 60 cm / 24"

599-01-30	599-05-30	599-09-30	599-13-30	599-17-30	599-21-30	599-25-30
599-02-40	599-06-40	599-10-40	599-14-40	599-18-40	599-22-40	599-26-40
599-03-50	599-07-50	599-11-50	599-15-50	599-19-50	599-23-50	599-27-50
599-04-60	599-08-60	599-12-60	599-16-60	599-20-60	599-24-60	599-28-60

Chevalier-Jackson  
 599-01-30 To 599-28-60

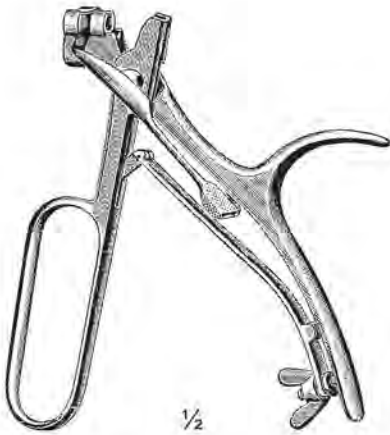

Huber  
**599-29-00**  
 Available with tube 599-32-20 To 599-43-20  
 Available with tip 600-01-00 To 600-43-00



Bruenings  
**599-30-00**  
 Available with tube 599-32-20 To 599-43-20  
 Available with tip 600-01-00 To 600-43-00

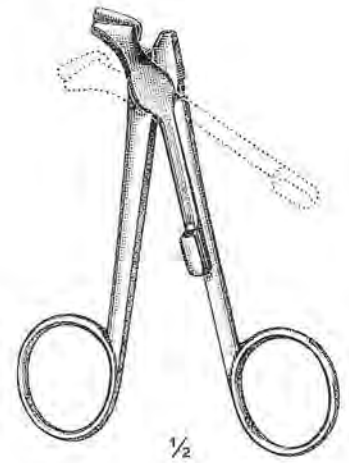

Yeoman  
**599-31-00**  
 Available with tube 599-32-20 To 599-43-20  
 Available with tip 600-01-00 To 600-43-00



599-32-20	20 cm / 8"
599-33-30	30 cm / 12"
599-34-40	40 cm / 16"
599-35-50	50 cm / 20"
599-36-60	60 cm / 24"

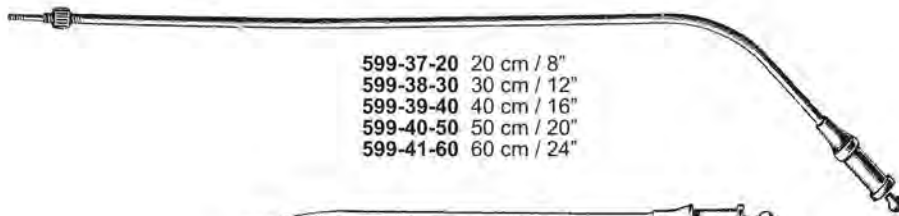

599-37-20	20 cm / 8"
599-38-30	30 cm / 12"
599-39-40	40 cm / 16"
599-40-50	50 cm / 20"
599-41-60	60 cm / 24"

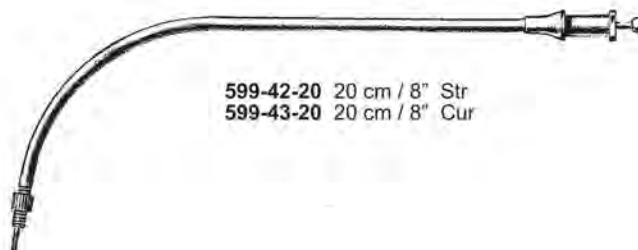

599-42-20	20 cm / 8" Str
599-43-20	20 cm / 8" Cur



**Broncho-Oesophagoskopiezangen**  
**Broncho-Esophagoscopy Forceps**  
**Pinces Pour Broncho-Esophagoscopie**



Fraenkel  
600-01-00



Fraenkel  
600-02-00



Fraenkel  
600-03-00



Lange  
600-04-00



Fraenkel  
600-05-00



Scheinmann  
600-06-00



Krause  
600-07-00



Scheinmann  
600-08-00



Eicken  
600-09-00



Seiffert  
600-10-00

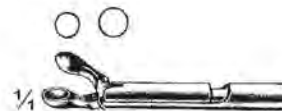

Bruenings  
600-11-03 3 mm Ø  
600-12-04 4 mm Ø



Bruenings  
600-13-03 3 mm Ø  
600-14-04 4 mm Ø



Bruenings  
600-15-02 2.5 X 5 mm  
600-16-03 3 X 6 mm



Krause  
600-17-00

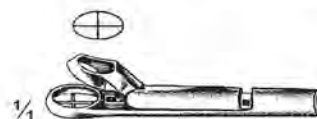

Krause  
600-18-00

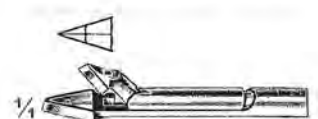

Schumacher  
600-19-00



Cordes  
600-20-04 4 mm Ø



Cordes (Rocenberg)  
600-21-03 3 mm  
600-22-04 4 mm  
600-23-05 5 mm



Cordes  
600-24-05 5 mm



Cordes  
600-25-04 4 mm Ø



Fraenkel  
600-26-00



Eicken  
600-27-00



Fraenkel  
600-28-00



Scheinman  
600-29-00



Cordes  
600-30-00

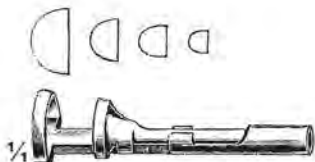

Cordes  
600-31-03 3 mm  
600-32-04 4 mm  
600-33-05 5 mm  
600-34-08 8 mm

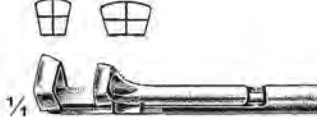

Cordes  
600-35-00  
600-36-00



Seiffert  
600-37-00



Bruenings  
600-38-03 3 mm Ø  
600-39-04 4 mm Ø



Bruenings  
600-40-02 2.5 X 5 mm  
600-41-03 3 X 6 mm



Krause  
600-42-00  
600-43-00

**Broncho-Oesophagoskopiezangen  
Broncho-Esophagoscopy Forceps  
Pinces Pour Broncho-Esophagoscopie**



Jaw 2 mm

Rintne Hospital  
**601-01-35**  
35 cm / 14"

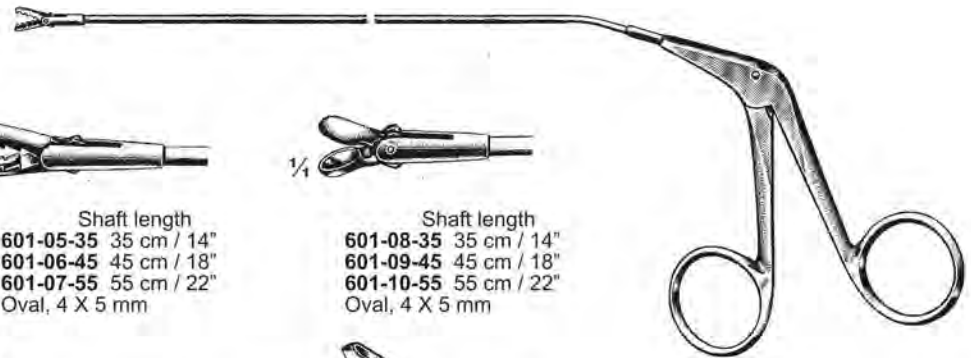

**601-02-35 To 601-22-55**



Shaft length  
**601-02-35** 35 cm / 14"  
**601-03-45** 45 cm / 18"  
**601-04-55** 55 cm / 22"



Shaft length  
**601-05-35** 35 cm / 14"  
**601-06-45** 45 cm / 18"  
**601-07-55** 55 cm / 22"  
Oval, 4 X 5 mm



Shaft length  
**601-08-35** 35 cm / 14"  
**601-09-45** 45 cm / 18"  
**601-10-55** 55 cm / 22"  
Oval, 4 X 5 mm



Shaft length  
**601-11-35** 35 cm / 14"  
**601-12-45** 45 cm / 18"  
**601-13-55** 55 cm / 22"



Shaft length  
**601-14-35** 35 cm / 14"  
**601-15-45** 45 cm / 18"  
**601-16-55** 55 cm / 22"



Shaft length  
**601-17-35** 35 cm / 14"  
**601-18-45** 45 cm / 18"  
**601-19-55** 55 cm / 22"  
Oval, 3 X 5 mm



Shaft length  
**601-21-35** 35 cm / 14"  
**601-21-45** 45 cm / 18"  
**601-22-55** 55 cm / 22"



**601-23-45**



**601-24-45**



**601-25-45**



Tucker  
**601-26-45**



**601-27-45**



**601-28-45**



**601-29-45**

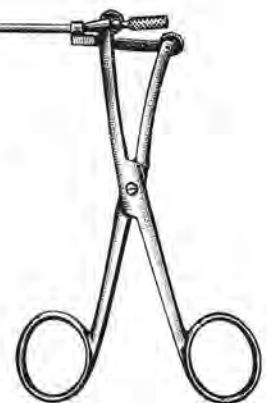

Original-Jackson  
**601-23-45 To 601-29-45**  
45 cm / 18"  
4 mm Ø

**Broncho-Oesophagoskopiezangen  
Broncho-Esophagoscopey Forceps  
Pinces Pour Broncho-Esophagoscopie**



**602-01-24**  
Shaft 24 cm / 9½"



**602-02-24**  
Shaft 24 cm / 9½"



**602-03-24**



**602-03-24 To 602-09-24**  
Shaft 24 cm / 9½"  
30°



**602-04-24**  
Scissors



**602-05-24**  
Scissors



**602-06-24**



**602-07-24**



**602-08-24**



**602-09-24**



**Chevalier-Jackson**  
**602-10-30** 30 cm / 12"  
Serrated jaw



**Chevalier-Jackson**  
**602-11-30** 30 cm / 12"  
**602-12-35** 35 cm / 14"  
**602-13-40** 40 cm / 16"  
**602-14-50** 50 cm / 20"  
Scooped serrated  
jaw



**Chevalier-Jackson**  
**602-15-30** 30 cm / 12"  
**602-16-35** 35 cm / 14"  
**602-17-40** 40 cm / 16"  
**602-18-50** 50 cm / 20"  
Scooped serrated  
jaw, light weight

**602-10-30 To 602-33-50**



**Chevalier-Jackson**  
**602-19-28** 28 cm / 11"  
**602-20-35** 35 cm / 14"  
**602-21-40** 40 cm / 16"  
**602-22-50** 50 cm / 20"  
Upward cur cup jaws



**Chevalier-Jackson**  
**602-23-30** 30 cm / 12"  
**602-24-40** 40 cm / 16"  
Cur to upward, round  
cup jaw, light weight



**Peterson**  
**602-25-30** 30 cm / 12"  
**602-26-35** 35 cm / 14"  
**602-27-40** 40 cm / 16"  
**602-28-45** 45 cm / 18"  
**602-29-50** 50 cm / 20"  
Scooped jaw



**Peterson**  
**602-30-30** 30 cm / 12"  
**602-31-35** 35 cm / 14"  
**602-32-45** 45 cm / 18"  
**602-33-50** 50 cm / 20"  
Scooped jaw,  
Light weight

**Broncho-Oesophagoskopiezangen  
Broncho-Esophagoscopy Forceps  
Pinces Pour Broncho-Esophagoscopie**

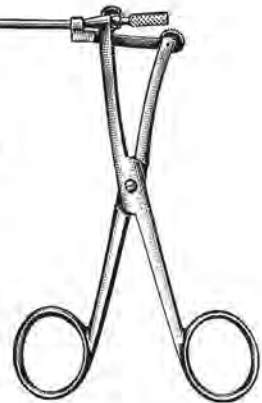

Original-Jackson  
603-01-40 To 603-03-40  
40 cm / 16"  
3 mm Ø

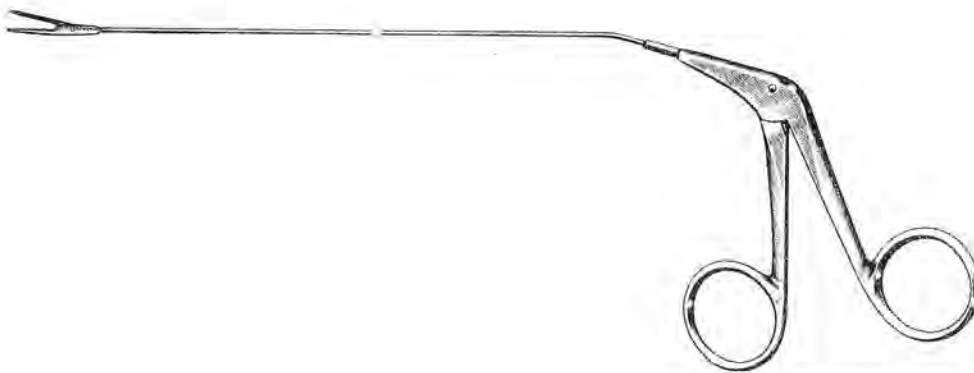

603-01-24 To 603-25-24  
Shaft 24 cm / 9½"



**Broncho-Oesophagoskopiezangen  
Broncho-Esophagoscopy Forceps  
Pincettes Pour Broncho-Esophagoscopie**

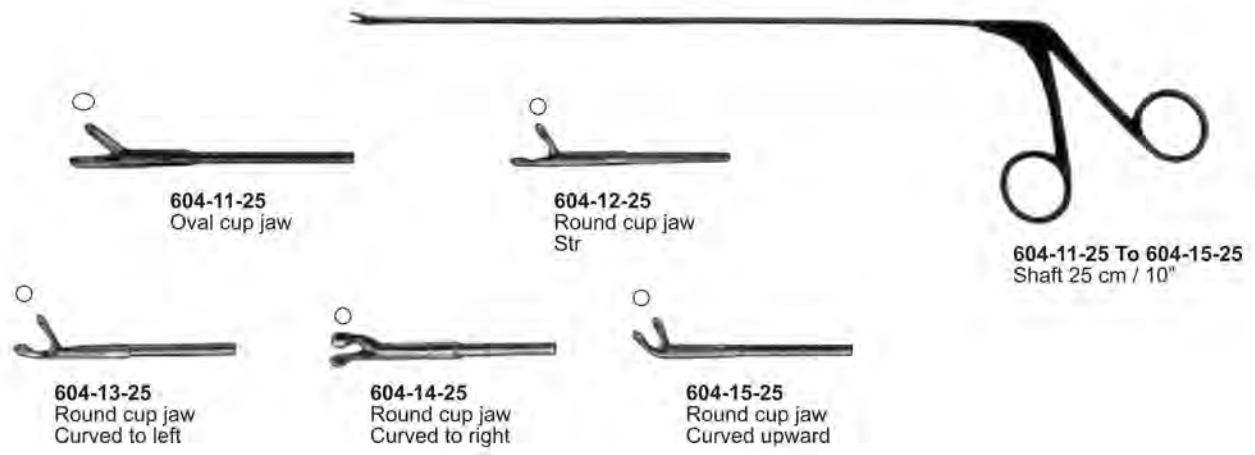
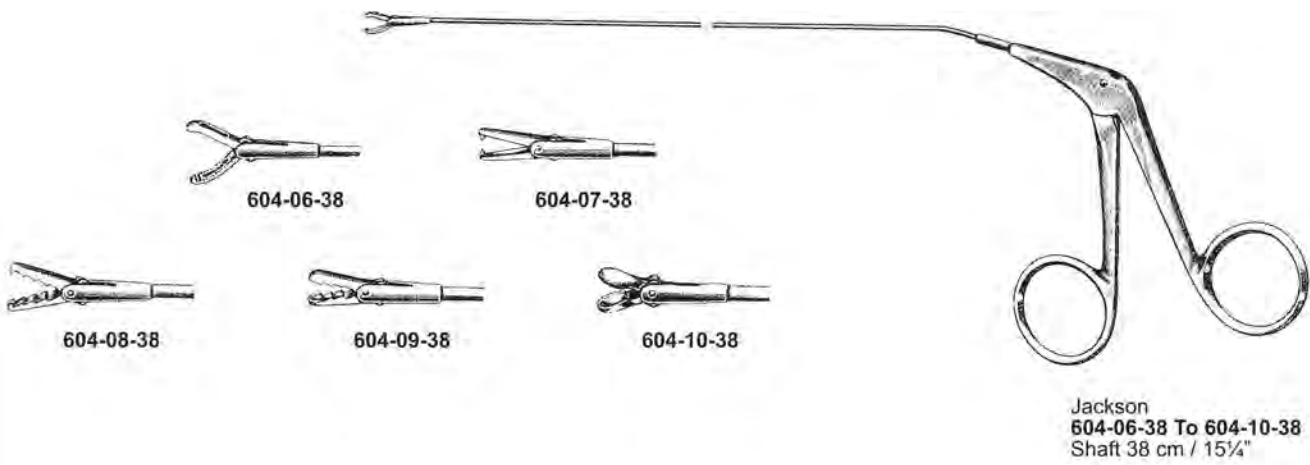
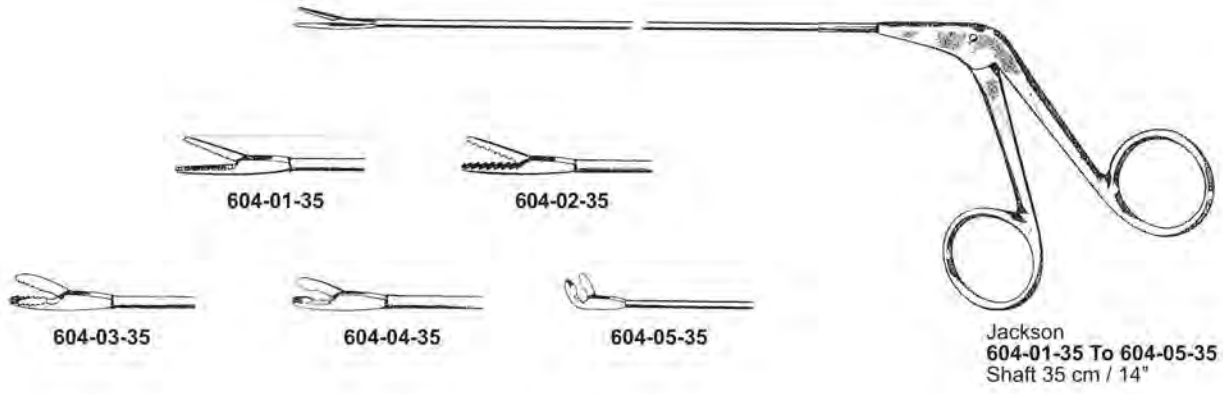

# Laryngeal Zange Laryngeal Forceps Forceps Larynges

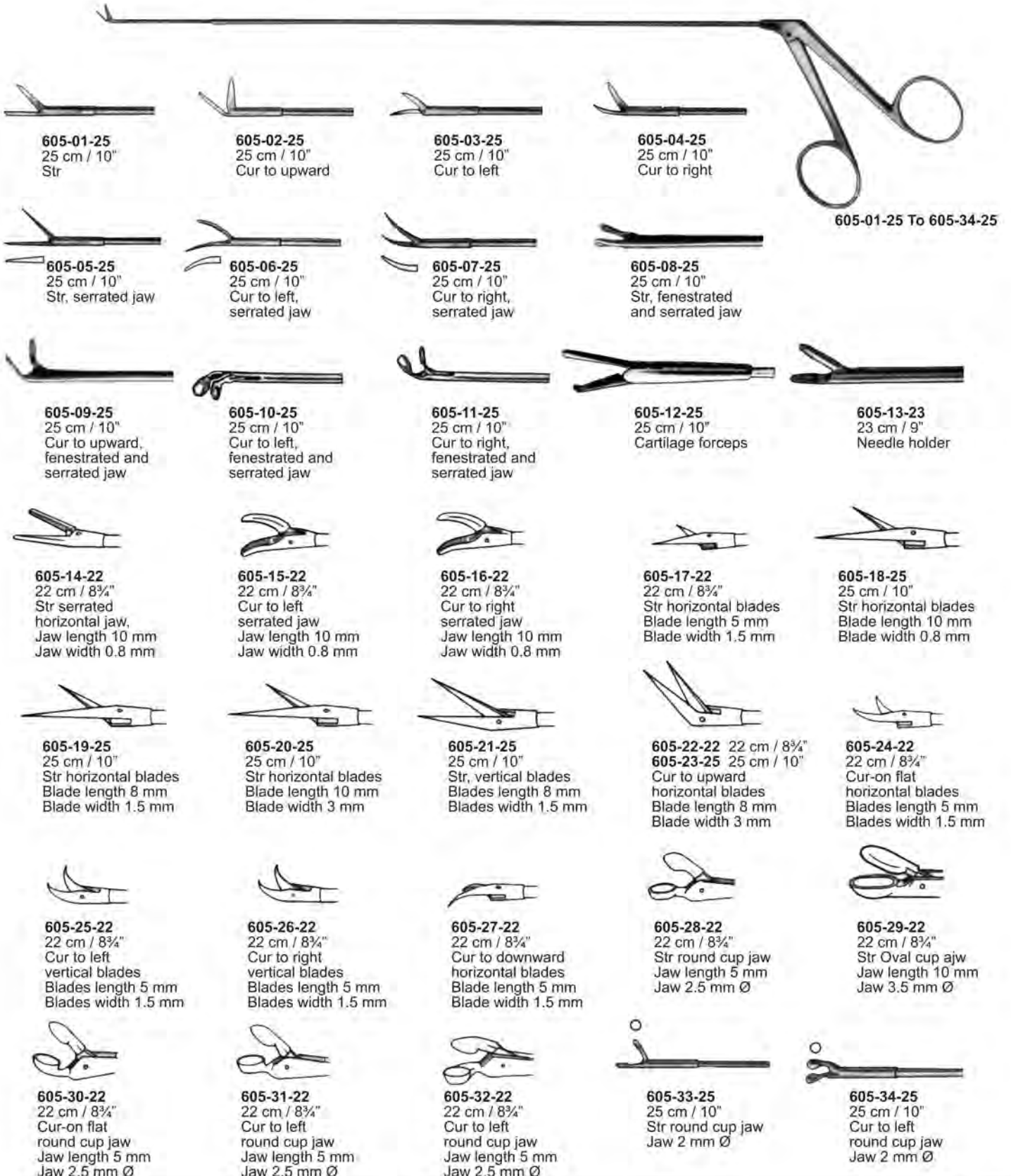

**Laryngeal Zange  
Laryngeal Forceps  
Forceps Larynges**



**606-01-15**  
Str serrated jaw  
Jaw length 4 mm  
Jaw width 1 mm



**606-02-15**  
Str serrated jaw  
Jaw length 8 mm  
Jaw width 1 mm



**606-03-15**  
Curved to left  
Serrated jaw  
Jaw length 4 mm  
Jaw width 1 mm



**606-04-15**  
Curved to right  
Serrated jaw  
Jaw length 4 mm  
Jaw width 1 mm

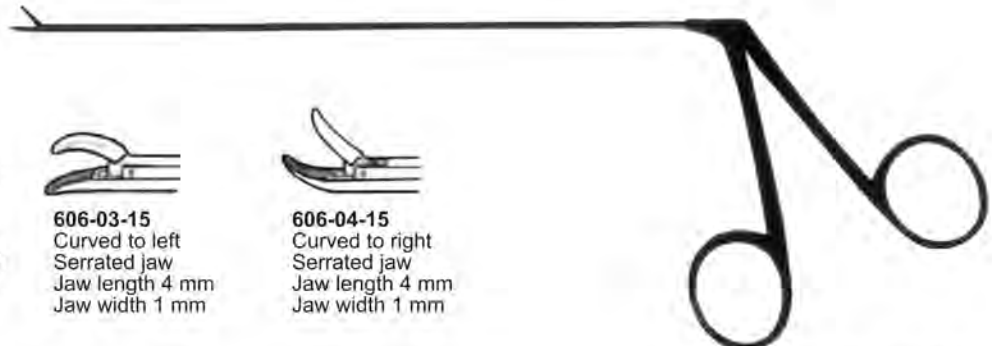

**606-01-15 To 606-07-15**  
Shaft length 15 cm / 6"



**606-05-15**  
Str  
Blade length 4 mm  
Blade width 1.5 mm



**606-06-15**  
Curved to left  
Blade length 4 mm  
Blade width 1.5 mm



**606-07-15**  
Curved to right  
Blade length 4 mm  
Blade width 1.5 mm



Mackay  
**606-08-12**  
Shaft length 12 cm / 4¾"  
Angled to right  
Blades length 10 mm



Mackay  
**606-09-12**  
Shaft length 12 cm / 4¾"  
Str, blades length 10 mm



Mackay-Chomper  
**606-10-12**  
Shaft length 12 cm / 4¾"  
Bite 9 X 4 mm

**Trachealtrokar  
Tracheal Trocars  
Trocart pour la trachéotomie**

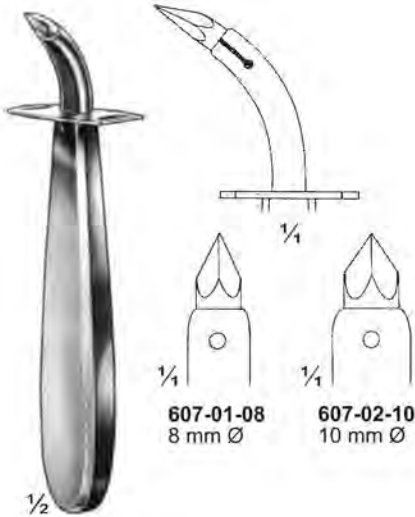

**607-01-08**  
8 mm Ø

**607-02-10**  
10 mm Ø

**Uckermann**  
**607-01-08 & 607-02-10**  
13 cm / 5 1/8"



**Trousseau**  
**607-03-12**  
12 cm / 4 3/4"



**Laborde**  
**607-04-12**  
12.5 cm / 5"



**Laborde**  
**607-05-13**  
13.5 cm / 5 1/4"  
Strong pattern



**607-06-24**

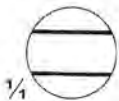

**607-07-24**



**607-06-24 & 607-07-24**  
24 cm / 9 1/2"



**Weedra**  
**607-08-19**  
19 cm / 7 1/2"



**Iterson**  
**607-09-16 & 607-10-16**  
16 cm / 6 1/4"



**Trachealhaken  
Tracheal Hooks  
Ecarteurs pour trachéotomie**

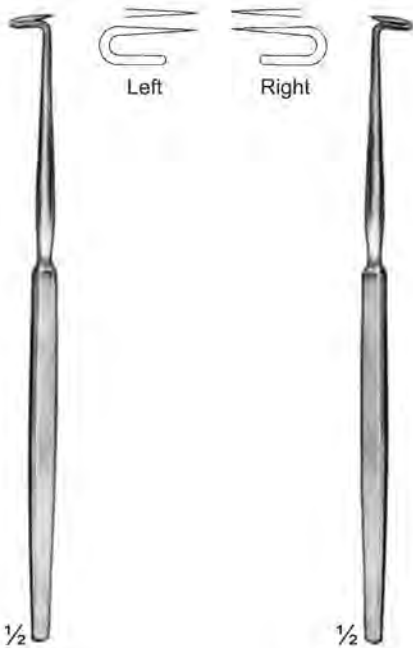

$\frac{1}{2}$   
Bose  
608-01-16  
16 cm / 6 $\frac{1}{4}$ "

$\frac{1}{2}$   
Bose  
608-02-16  
16 cm / 6 $\frac{1}{4}$ "



608-03-18 To 608-05-18  
18 cm / 7"



$\frac{1}{4}$   
608-03-18  
Sharp



$\frac{1}{4}$   
608-04-18  
Blunt



$\frac{1}{4}$   
608-05-18  
Blunt



$\frac{1}{4}$

13 X 6 mm



$\frac{1}{2}$   
Schoenborn  
608-06-20  
20 cm / 8"



$\frac{1}{2}$   
Bose  
608-07-06  
6 cm / 2 $\frac{1}{4}$ "



$\frac{1}{2}$   
Finsen  
608-08-05  
5 cm / 2"



$\frac{1}{2}$   
Finsen  
608-09-07  
7 cm / 2 $\frac{3}{4}$ "



$\frac{1}{2}$   
Finsen modi.  
608-10-07  
7.5 cm / 3"



$\frac{1}{2}$   
Finsen  
608-11-07  
7 cm / 2 $\frac{3}{4}$ "

**Trachealthaken  
Tracheal Hooks  
Ecarteurs pour trachéotomie**

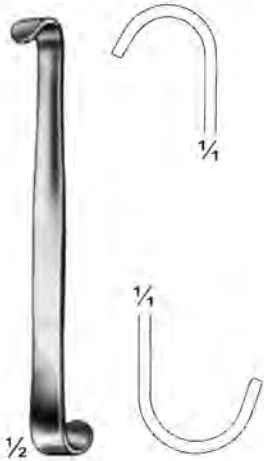

Luer  
609-01-11  
11 cm / 4 1/4"



Jackson  
609-02-15  
15 cm / 6"



609-03-15  
15 cm / 6"

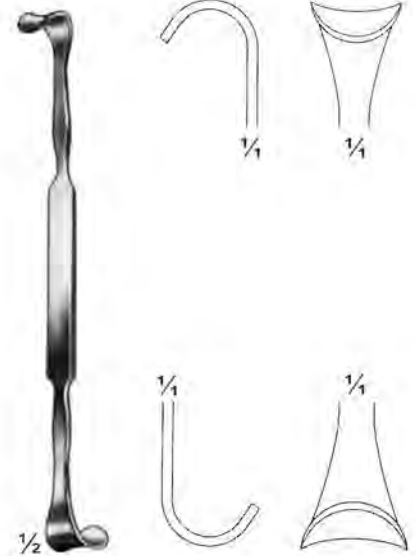

Rose  
609-04-13  
13 cm / 5 1/4"



Jackson  
609-05-18  
18 cm / 7"

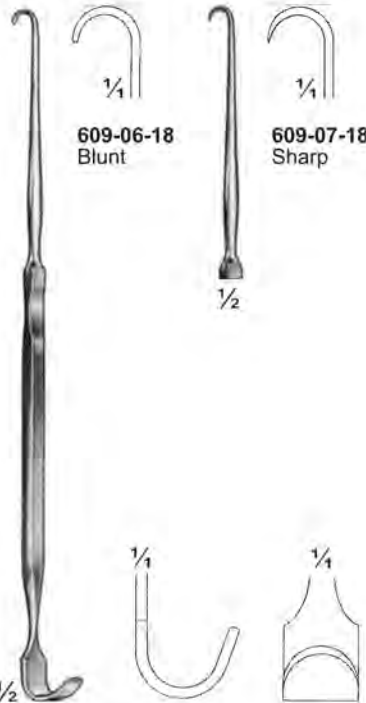

Jackson  
609-06-18 & 609-07-18  
18 cm / 7"



Lukens  
609-08-17  
17 cm / 6 3/4"



Wagener-Mosher  
609-09-05 5 mm Ø  
609-10-07 7 mm Ø  
609-11-09 9 mm Ø  
21 cm / 8 1/4"

**Trachealkanülen  
Tracheal Tubes  
Canules tracheales**



**Jackson**  
Stainless steel

<b>610-01-04</b> Fig. 0	4 Ø X 50 mm	<b>610-12-04</b>
<b>610-02-05</b> Fig. 1	5 Ø X 48 mm	<b>610-13-05</b>
<b>610-03-06</b> Fig. 2	6 Ø X 58 mm	<b>610-14-06</b>
<b>610-04-07</b> Fig. 3	7 Ø X 70 mm	<b>610-15-07</b>
<b>610-05-08</b> Fig. 4	8 Ø X 78 mm	<b>610-16-08</b>
<b>610-06-09</b> Fig. 5	9 Ø X 84 mm	<b>610-17-09</b>
<b>610-07-10</b> Fig. 6	10 Ø X 84 mm	<b>610-18-10</b>
<b>610-08-11</b> Fig. 7	11 Ø X 86 mm	<b>610-19-11</b>
<b>610-09-12</b> Fig. 8	12 Ø X 88 mm	<b>610-20-12</b>
<b>610-10-13</b> Fig. 9	13 Ø X 90 mm	<b>610-21-13</b>
<b>610-11-14</b> Fig. 10	14 Ø X 90 mm	<b>610-22-14</b>

German silver



Stainless steel

<b>610-23-09</b> Fig. 5	9 Ø X 65 mm	<b>610-26-09</b>
<b>610-24-10</b> Fig. 6	10 Ø X 70 mm	<b>610-27-10</b>
<b>610-25-11</b> Fig. 7	11 Ø X 80 mm	<b>610-28-11</b>

German silver



**Chevallier-Jackson**  
Stainless steel

<b>610-29-04</b> Fig. 0	4 Ø X 50 mm	<b>610-40-04</b>
<b>610-30-05</b> Fig. 1	5 Ø X 48 mm	<b>610-41-05</b>
<b>610-31-06</b> Fig. 2	6 Ø X 58 mm	<b>610-42-06</b>
<b>610-32-07</b> Fig. 3	7 Ø X 70 mm	<b>610-43-07</b>
<b>610-33-08</b> Fig. 4	8 Ø X 78 mm	<b>610-44-08</b>
<b>610-34-09</b> Fig. 5	9 Ø X 84 mm	<b>610-45-09</b>
<b>610-35-10</b> Fig. 6	10 Ø X 84 mm	<b>610-46-10</b>
<b>610-36-11</b> Fig. 7	11 Ø X 86 mm	<b>610-47-11</b>
<b>610-37-12</b> Fig. 8	12 Ø X 88 mm	<b>610-48-12</b>
<b>610-38-13</b> Fig. 9	13 Ø X 90 mm	<b>610-49-13</b>
<b>610-39-14</b> Fig. 10	14 Ø X 90 mm	<b>610-50-14</b>

German silver



**Collin**  
Stainless steel

<b>610-51-04</b> Fig. 0	4 Ø X 50 mm	<b>610-62-04</b>
<b>610-52-05</b> Fig. 1	5 Ø X 48 mm	<b>610-63-05</b>
<b>610-53-06</b> Fig. 2	6 Ø X 58 mm	<b>610-64-06</b>
<b>610-54-07</b> Fig. 3	7 Ø X 70 mm	<b>610-65-07</b>
<b>610-55-08</b> Fig. 4	8 Ø X 78 mm	<b>610-66-08</b>
<b>610-56-09</b> Fig. 5	9 Ø X 84 mm	<b>610-67-09</b>
<b>610-57-10</b> Fig. 6	10 Ø X 84 mm	<b>610-68-10</b>
<b>610-58-11</b> Fig. 7	11 Ø X 86 mm	<b>610-69-11</b>
<b>610-59-12</b> Fig. 8	12 Ø X 88 mm	<b>610-70-12</b>
<b>610-60-13</b> Fig. 9	13 Ø X 90 mm	<b>610-71-13</b>
<b>610-61-14</b> Fig. 10	14 Ø X 90 mm	<b>610-72-14</b>

German silver

# Trachealkanülen Tracheal Tubes Canules tracheales



Luer		
Stainless steel		German silver
611-01-08 Fig. 4	8 Ø X 65 mm	611-07-08
611-02-09 Fig. 5	9 Ø X 70 mm	611-08-09
611-03-10 Fig. 6	10 Ø X 75 mm	611-09-10
611-04-11 Fig. 7	11 Ø X 80 mm	611-10-11
611-05-12 Fig. 8	12 Ø X 85 mm	611-11-12
611-06-13 Fig. 9	13 Ø X 90 mm	611-12-13



Luer		
Stainless steel		German silver
611-13-08 Fig. 4	8 Ø X 65 mm	611-19-08
611-14-09 Fig. 5	9 Ø X 70 mm	611-20-09
611-15-10 Fig. 6	10 Ø X 75 mm	611-21-10
611-16-11 Fig. 7	11 Ø X 80 mm	611-22-11
611-17-12 Fig. 8	12 Ø X 85 mm	611-23-12
611-18-13 Fig. 9	13 Ø X 90 mm	611-24-13



Luer		
Stainless steel		German silver
611-25-08 Fig. 4	8 Ø X 65 mm	611-31-08
611-26-09 Fig. 5	9 Ø X 70 mm	611-32-09
611-27-10 Fig. 6	10 Ø X 75 mm	611-33-10
611-28-11 Fig. 7	11 Ø X 80 mm	611-34-11
611-29-12 Fig. 8	12 Ø X 85 mm	611-35-12
611-30-13 Fig. 9	13 Ø X 90 mm	611-36-13



Krishaber		
Stainless steel		German silver
611-37-04 Fig. 0	4 Ø X 50 mm	610-46-04
611-38-05 Fig. 1	5 Ø X 48 mm	610-47-05
611-39-06 Fig. 2	6 Ø X 58 mm	610-48-06
611-40-07 Fig. 3	7 Ø X 70 mm	610-49-07
611-41-08 Fig. 4	8 Ø X 65 mm	611-50-08
611-42-09 Fig. 5	9 Ø X 70 mm	611-51-09
611-43-10 Fig. 6	10 Ø X 75 mm	611-52-10
611-44-11 Fig. 7	11 Ø X 80 mm	611-53-11
611-45-12 Fig. 8	12 Ø X 85 mm	611-54-12



Krishaber-Luer		
Stainless steel		German silver
611-55-04 Fig. 0	4 Ø X 50 mm	610-64-04
611-56-05 Fig. 1	5 Ø X 48 mm	610-65-05
611-57-06 Fig. 2	6 Ø X 58 mm	610-66-06
611-58-07 Fig. 3	7 Ø X 70 mm	610-67-07
611-59-08 Fig. 4	8 Ø X 65 mm	611-68-08
611-60-09 Fig. 5	9 Ø X 70 mm	611-69-09
611-61-10 Fig. 6	10 Ø X 75 mm	611-70-10
611-62-11 Fig. 7	11 Ø X 80 mm	611-71-11
611-63-12 Fig. 8	12 Ø X 85 mm	611-72-12

## Trachealkanülen Tracheal Tubes Canules tracheales



Schroetter  
612-01-01  
Fig. 1



Schroetter  
612-02-02  
Fig. 2



Schroetter  
612-03-03  
Fig. 3



Schroetter  
612-04-04  
Fig. 4



Schroetter  
612-05-05  
Fig. 5



Schroetter  
612-06-06  
Fig. 6



Schroetter  
612-07-07  
Fig. 7



Schroetter  
612-08-08  
Fig. 8



Schroetter  
612-09-09  
Fig. 9



Schroetter  
612-10-10  
Fig. 10



Schroetter  
612-11-11  
Fig. 11



Schroetter  
612-12-12  
Fig. 12

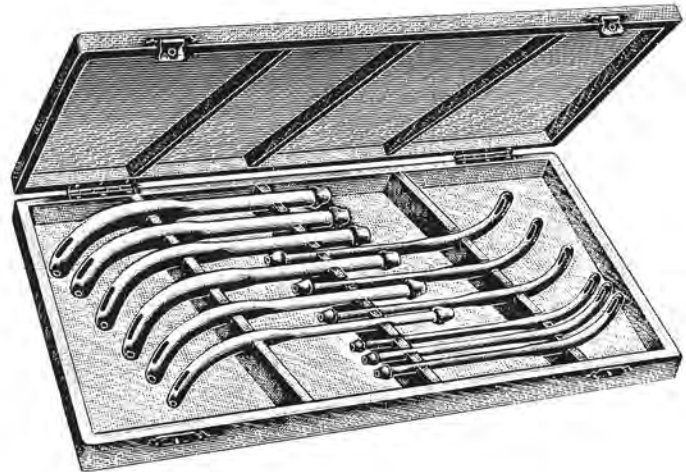

Schroetter  
Complete consisting:  
12 Schroetter dialators 612-01-01 To 612-12-12  
612-13-00 Packed in wooden case  
612-14-00 Packed in stainless case

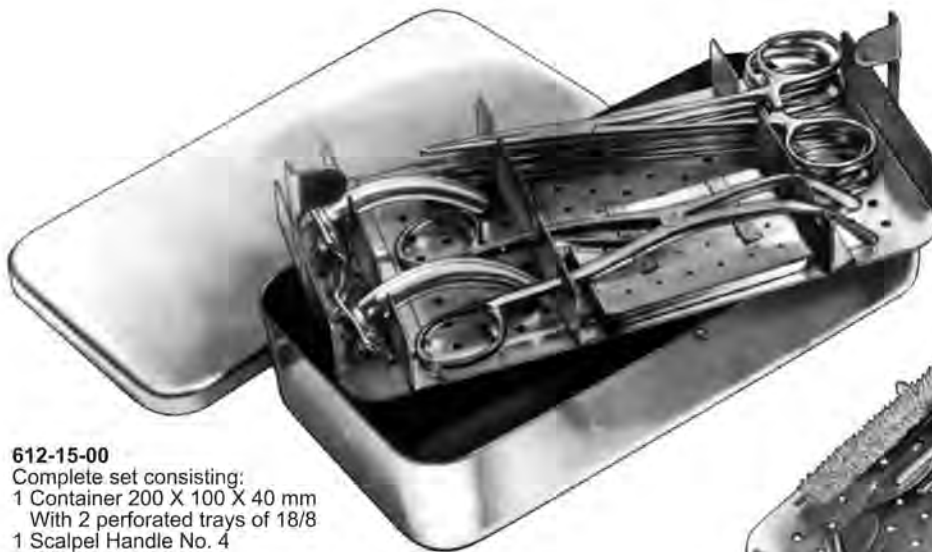

### 612-15-00

Complete set consisting:

- 1 Container 200 X 100 X 40 mm  
With 2 perforated trays of 18/8
- 1 Scalpel Handle No. 4
- 1 Scalpel Blade No. 23
- 3 Scalpel Blades, assorted
- 1 Small case for above scalpel blades
- 1 Dressing Forceps, 13cm, Serrated
- 2 Tissue Forceps, 13cm, 1x2 Teeth
- 4 Crile Forceps, 14cm, Str
- 1 Grooved Director, 13cm
- 1 Trousseau Trachea Dilator, 14cm
- 2 Iterson Trachea Hooks, Blunt
- 1 Bose Hook, Sharp, Left hand side, 16cm
- 1 Bose Hook, Sharp, Right hand side, 16cm
- 1 Luer Trachea Tube, size 2.6 mm dia, German Silver
- 1 Luer Trachea Tube, size 4.8 mm dia, German Silver
- 1 Cleaning Brush, 12 mm dia, 27cm
- 1 Plastic Pouch for this set



Nasenspekula  
Nasal Speculam  
Spéculum nasaux



613-01-13  
613-04-13  
Fig. 0  
Infant



1/4

613-02-13  
613-05-13  
Fig. 1  
Child



1/4

613-03-13  
613-06-13  
Fig. 2  
Child



1/4

Hartmann  
613-01-13 To 613-03-13  
13.5 cm / 5 1/4"



Hartmann  
613-04-13 To 613-06-13  
13.5 cm / 5 1/4"  
With wire spring



Hartmann  
613-07-15 To 613-09-15  
15 cm / 6"  
Adult

613-07-15  
613-10-15  
Fig. 1  
Small

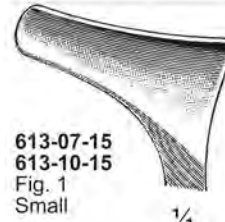

1/4

613-08-15  
613-11-15  
Fig. 2  
Medium

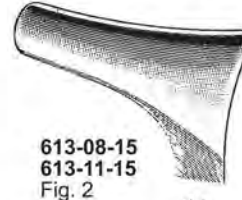

1/4

613-09-15  
613-12-15  
Fig. 3  
Large

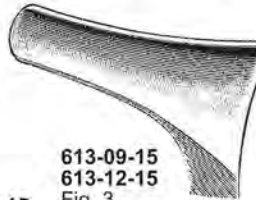

1/4



Hartmann  
613-10-15 To 613-12-15  
15 cm / 6"  
Adult



Hartmann-Halle  
613-13-15 To 613-15-15  
15 cm / 6"

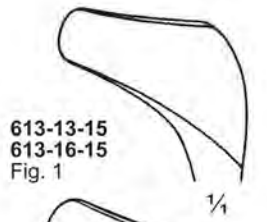

613-13-15  
613-16-15  
Fig. 1

1/4

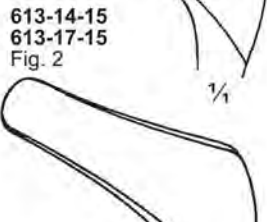

613-14-15  
613-17-15  
Fig. 2

1/4

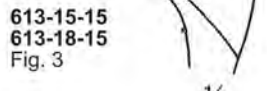

613-15-15  
613-18-15  
Fig. 3

1/4



Hartmann-Halle  
613-16-15 To 613-18-15  
15 cm / 6"



Schwarz  
613-19-14  
14 cm / 5 1/2"



Mod. Wein  
613-20-14  
14.5 cm / 5 3/4"

Nasenspekula  
Nasal Speculam  
Spéculum nasaux



614-01-14  
Fig. 1  
Small

1/4

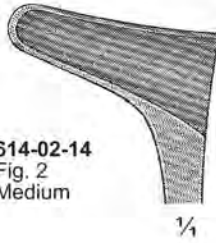

614-02-14  
Fig. 2  
Medium

1/4



614-03-14  
Fig. 3  
Large

1/4



1/4

1/2

614-04-13  
13 cm / 5 1/4"



1/4

1/2

614-05-13  
13 cm / 5 1/4"

Vienna  
614-01-14 To 614-03-14  
14.5 cm / 5 3/4"  
Light weight



1/4

1/2

Sonnenschein  
614-06-14  
14 cm / 5 1/2"



1/2

Beckmann  
614-07-15 To 614-10-15  
15 cm / 6"



614-07-15  
614-11-15  
Fig. 1  
Child

1/4



614-09-15  
614-13-15  
Fig. 3  
Medium

1/4



614-08-15  
614-12-15  
Fig. 2  
Small

1/4

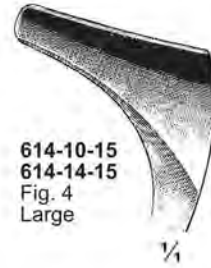

614-10-15  
614-14-15  
Fig. 4  
Large

1/4



1/2

Beckmann  
614-11-15 To 614-14-15  
15 cm / 6"

Nasenspekula  
Nasal Speculam  
Spéculum nasaux



614-01-14  
Fig. 1  
Small

1/4

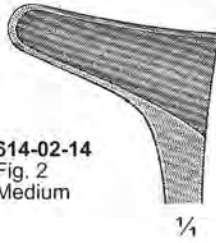

614-02-14  
Fig. 2  
Medium

1/4



614-03-14  
Fig. 3  
Large

1/4



1/4

1/2

614-04-13  
13 cm / 5 1/4"

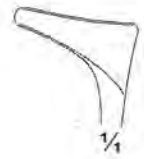

1/4

1/2

614-05-13  
13 cm / 5 1/4"

Vienna  
614-01-14 To 614-03-14  
14.5 cm / 5 3/4"  
Light weight



1/4

1/2

Sonnenschein  
614-06-14  
14 cm / 5 1/2"



1/2

Beckmann  
614-07-15 To 614-10-15  
15 cm / 6"



614-07-15  
614-11-15  
Fig. 1  
Child

1/4



614-09-15  
614-13-15  
Fig. 3  
Medium

1/4



614-08-15  
614-12-15  
Fig. 2  
Small

1/4

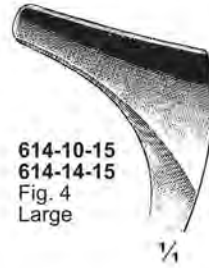

614-10-15  
614-14-15  
Fig. 4  
Large

1/4



1/2

Beckmann  
614-11-15 To 614-14-15  
15 cm / 6"



Nasenspekula  
Nasal Speculam  
Spéculum nasaux



Cottle  
616-01-15 To 616-04-15  
15 cm / 6"

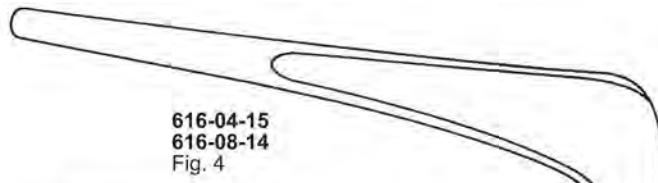

616-04-15  
616-08-14  
Fig. 4

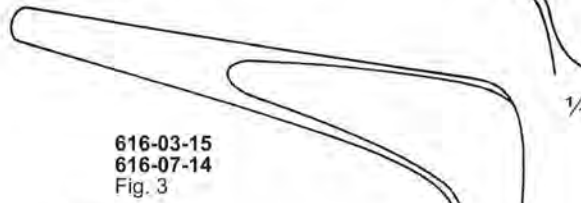

616-03-15  
616-07-14  
Fig. 3

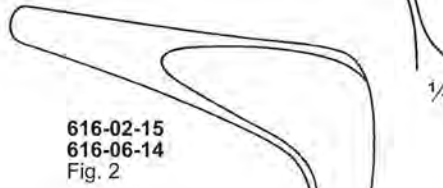

616-02-15  
616-06-14  
Fig. 2

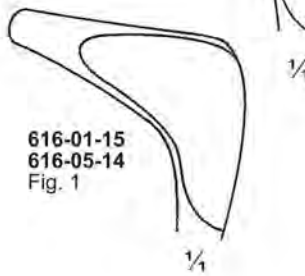

616-01-15  
616-05-14  
Fig. 1



Cottle  
616-05-14 To 616-08-14  
14 cm / 5½"



Wiener Model  
616-09-15 To 616-11-15  
15 cm / 6"

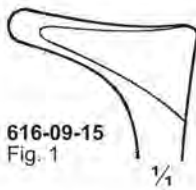

616-09-15  
Fig. 1

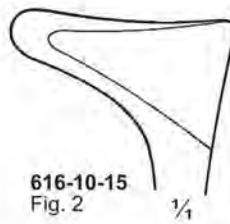

616-10-15  
Fig. 2

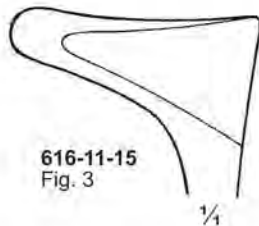

616-11-15  
Fig. 3



Tieck-Halle  
616-12-13  
13.5 cm / 5¼"

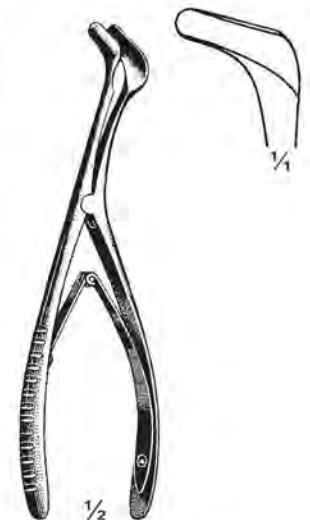

Tieck-Halle  
616-13-13  
13.5 cm / 5¼"

Nasenspekula  
Nasal Speculam  
Spéculum nasaux



Wiener Model  
617-01-14 To 617-03-14  
14 cm / 5½"



617-01-14  
Fig. 1  
Small

617-02-14  
Fig. 2  
Medium

617-03-14  
Fig. 3  
Large



Wiener Model  
617-04-13 & 617-05-13  
13 cm / 5¼"

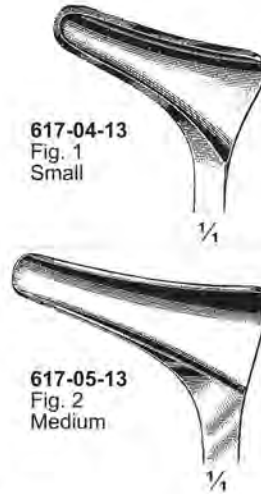

617-04-13  
Fig. 1  
Small

617-05-13  
Fig. 2  
Medium



USA Model  
617-06-30 30 mm Blades  
617-07-40 40 mm Blades  
617-08-50 50 mm Blades  
15 cm / 6"  
Fenestrated blades



Fraenkel  
617-09-08  
8 cm / 3"



Patton  
617-10-00



617-11-01  
Fig. 1  
Small

617-12-02  
Fig. 2  
Medium

617-13-03  
Fig. 3  
Large



Thudicheum  
(Goldsmith)  
617-11-01 To 617-13-03  
6.5 cm / 2½"

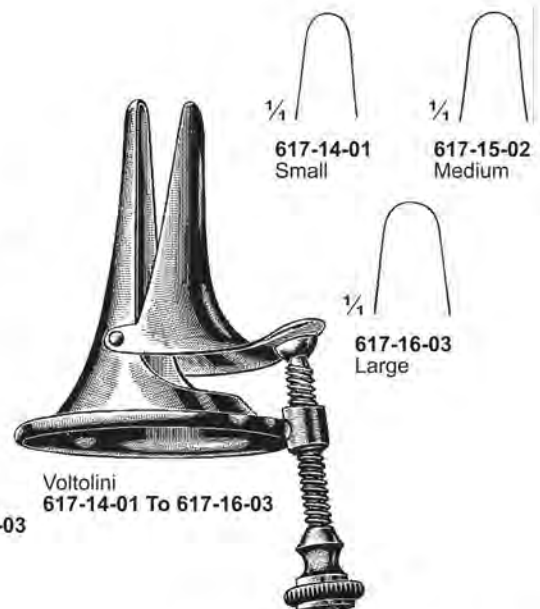

617-14-01  
Small

617-15-02  
Medium

617-16-03  
Large

Voltolini  
617-14-01 To 617-16-03

**Nasenspekula  
Nasal Speculam  
Spéculums nasaux**



Fraenkel  
618-01-00



Cholewa  
618-02-15  
15 cm / 6"



Lange-Wilde  
618-03-26  
26 cm / 10 1/4"



Krause  
618-04-26  
26 cm / 10 1/4"



Krause-Voss  
618-05-26  
26 cm / 10 1/4"



Jackson  
618-06-22  
22 cm / 8 3/4"



Seiler  
618-07-16  
16 cm / 6 1/4"

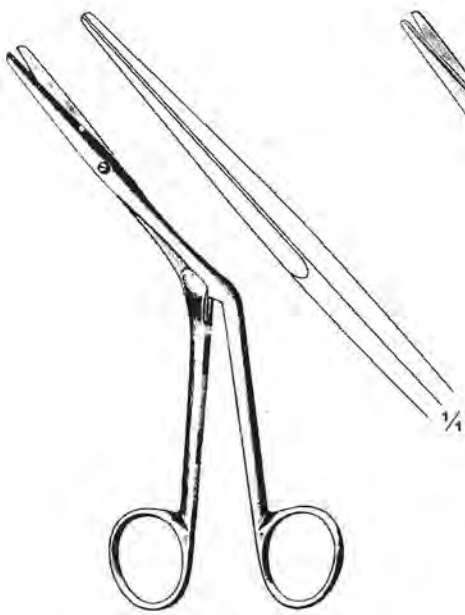

Knight  
618-08-18  
18 cm / 7"

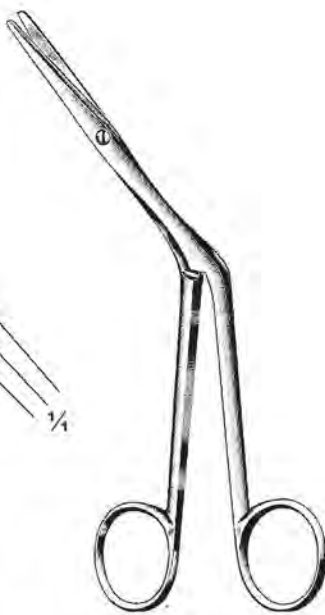

Heymann  
618-09-18  
18 cm / 7"



Kirstein  
618-10-18  
18 cm / 7"

Nasenpolypenzangen  
 Nasal Polypus Forceps  
 Pincès à polypes nasaux

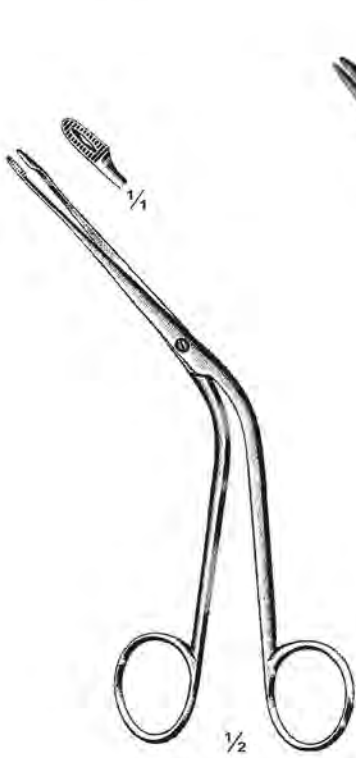

Hartmann  
 619-01-16  
 16 cm / 6 1/4"



Hartmann  
 619-02-20  
 20 cm / 8"



Heymann-Knight  
 619-03-18  
 18 cm / 7"

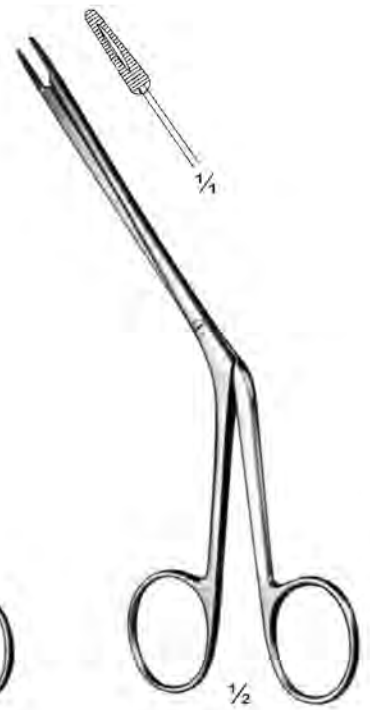

Littauer  
 619-04-18  
 18 cm / 7"

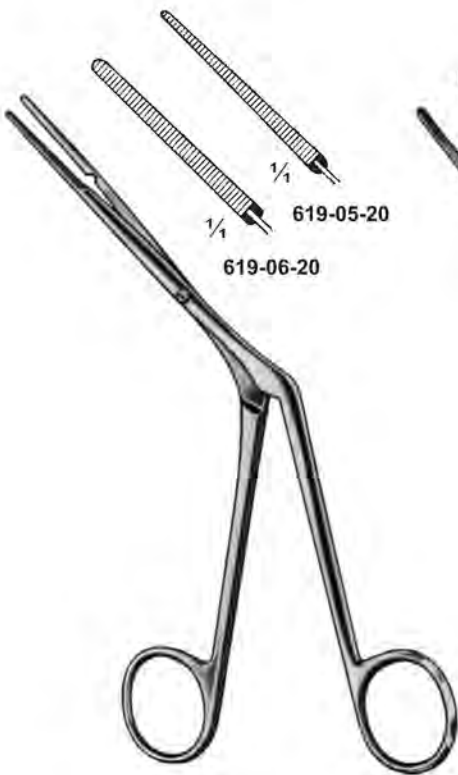

Westmacott  
 619-05-20 & 619-06-20  
 20 cm / 8"



Lubet-Barbon  
 619-07-20  
 20 cm / 8"



Knight  
 619-08-18  
 18 cm / 7"



Killian  
 619-09-17  
 17 cm / 6 3/4"

**Nasenpolypenzangen  
Nasal Polypus Forceps  
Pincès à polypes nasaux**

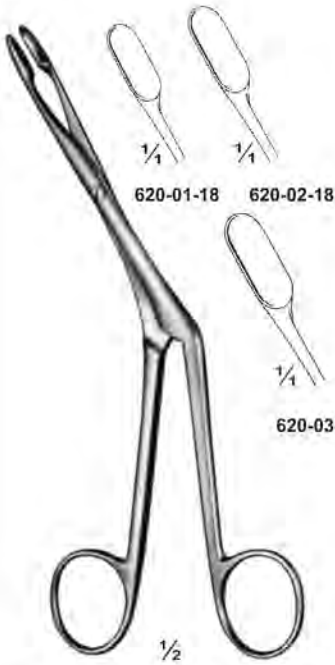

**Heymann**  
620-01-18 To 620-03-18  
18 cm / 7"

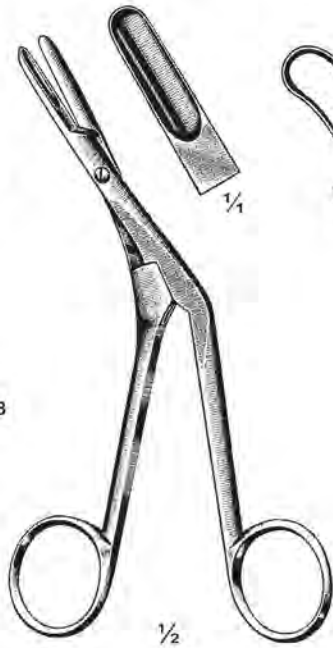

**Craig**  
620-04-18  
18 cm / 7"

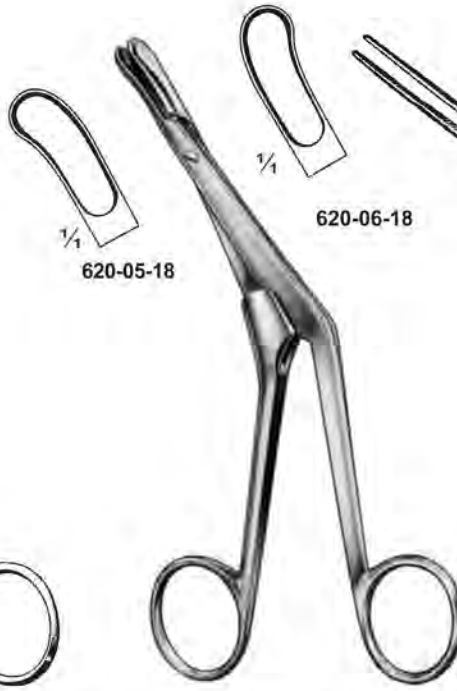

**Craig-Domnick**  
620-05-18 & 620-06-18  
18 cm / 7"

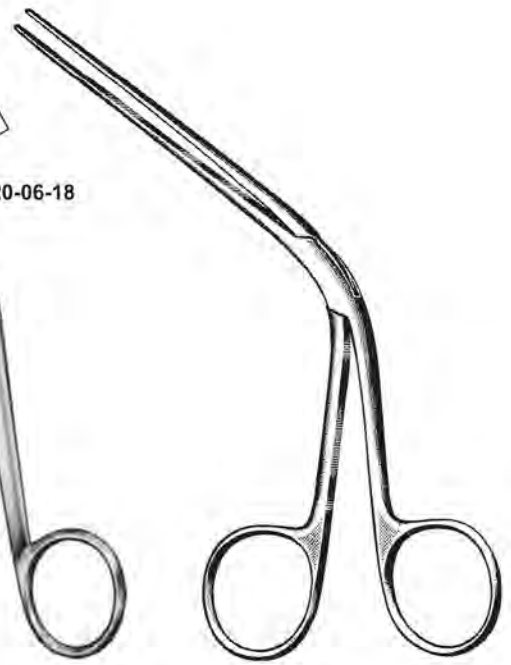

**Tilley**  
620-07-17  
17 cm / 6 3/4"



**Quire**  
620-08-12  
12 cm / 4 3/4"

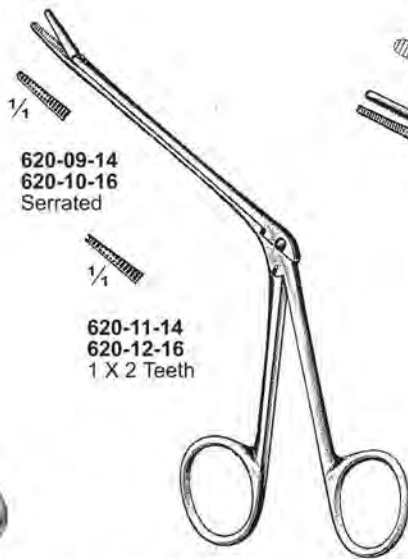

**Noyes**  
Serrated  
620-09-14 Shaft 14 cm / 5 1/2"    1 X 2 Teeth  
620-10-16 Shaft 16.5 cm / 6 1/2"    620-11-14  
620-12-16

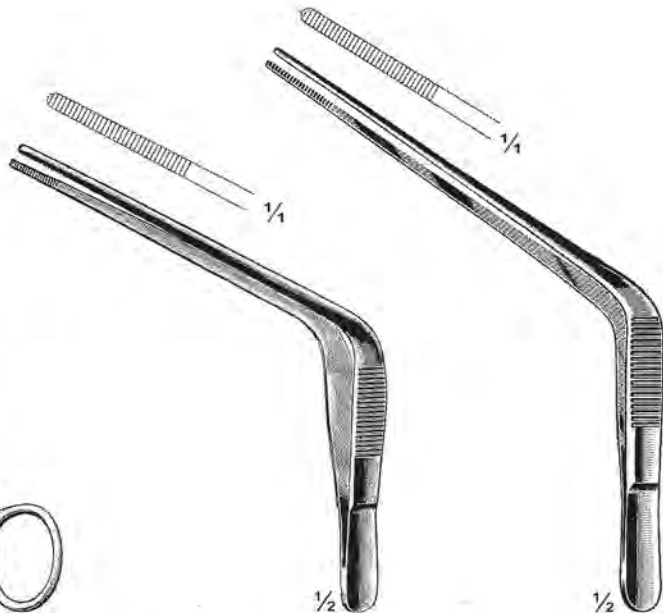

**Troeltsch**  
620-13-15  
15 cm / 6"

**Troeltsch**  
620-14-18  
18 cm / 7"



**Gruenwald (Jansen)**  
620-15-20  
20 cm / 8"

**Nasenpolypenzangen  
Nasal Polypus Forceps  
Pincès à polypes nasaux**

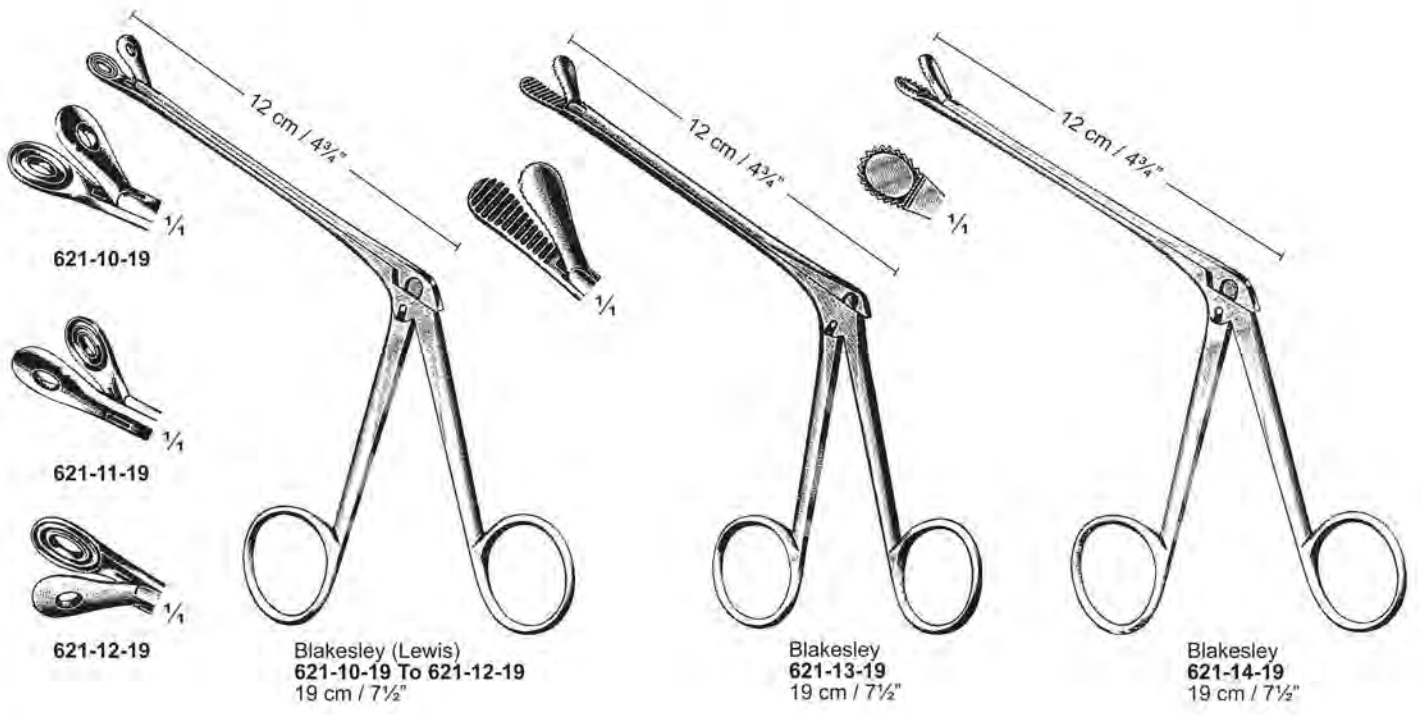
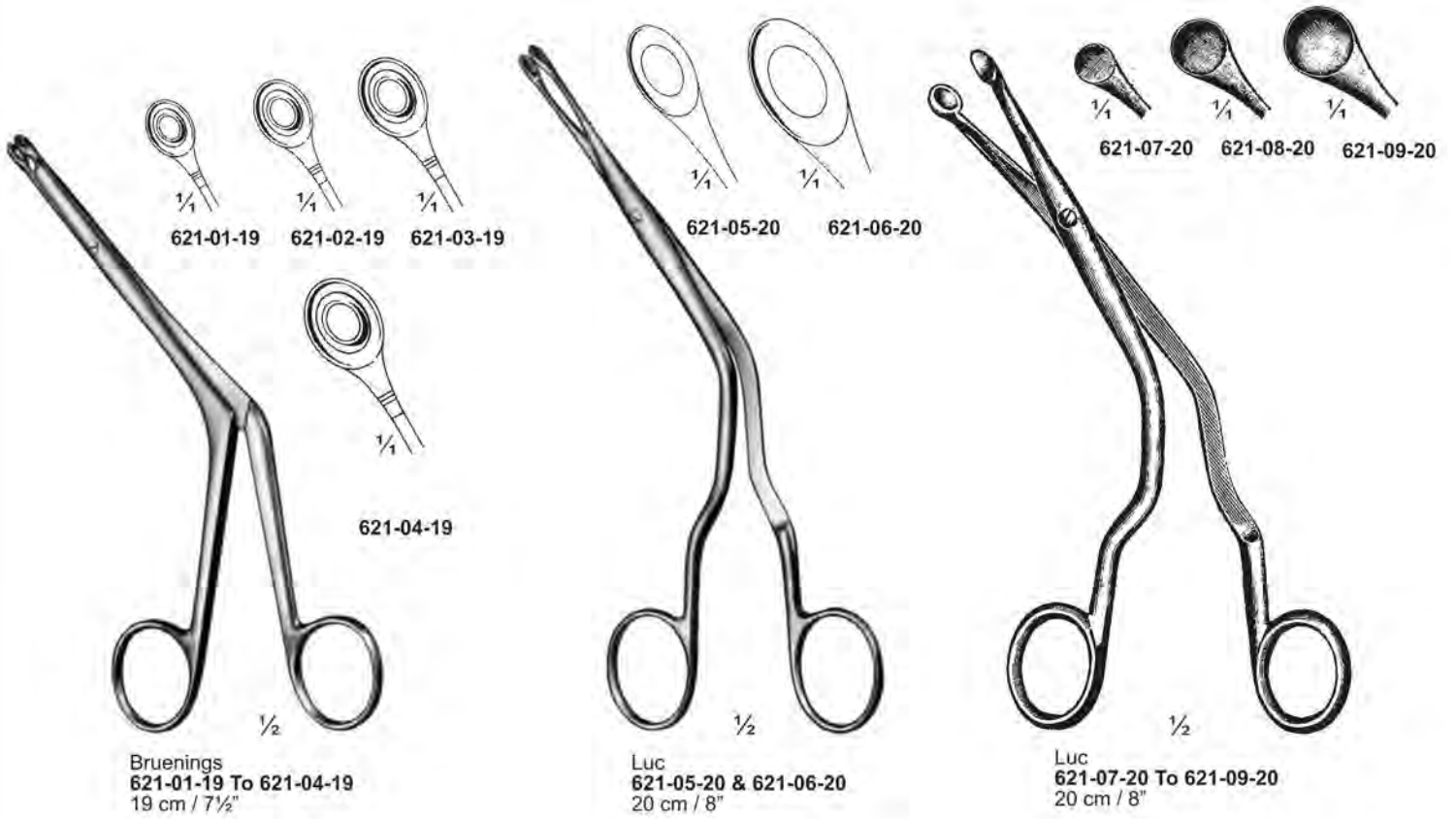

**Nasenpolypenzangen  
Nasal Polypus Forceps  
Pincès à polypes nasaux**



**Ferris-Smith**  
**622-01-19**  
19 cm / 7 1/2"

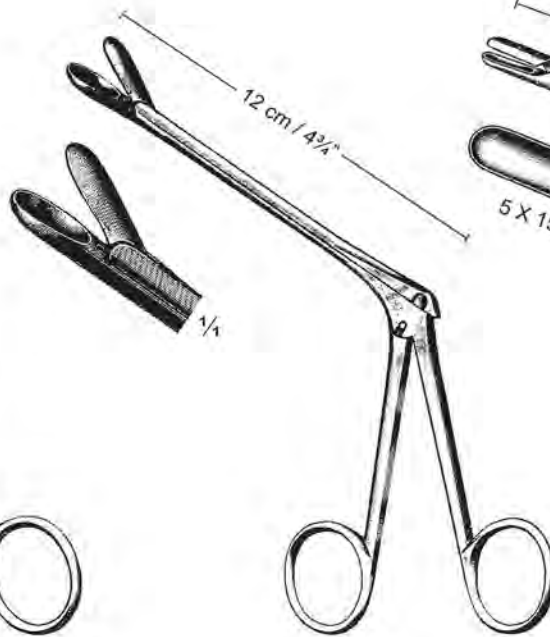

**Watson-Williams**  
**622-02-19**  
19 cm / 7 1/2"

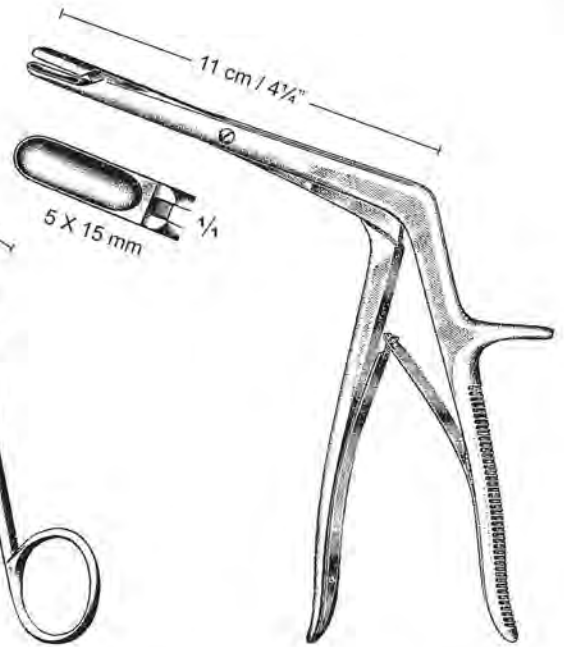

**Kofler**  
**622-03-23**  
23 cm / 9"

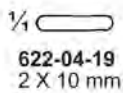

**622-04-19**  
2 X 10 mm

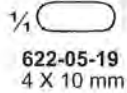

**622-05-19**  
4 X 10 mm

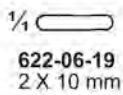

**622-06-19**  
2 X 10 mm

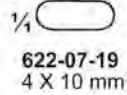

**622-07-19**  
4 X 10 mm

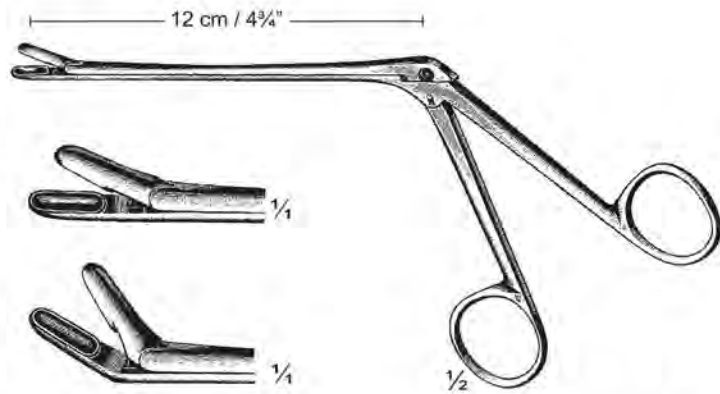

**Takahashi**  
**622-04-19 To 623-07-19**  
19 cm / 7 1/2"



**Weil**  
**622-08-19**



**622-09-19**

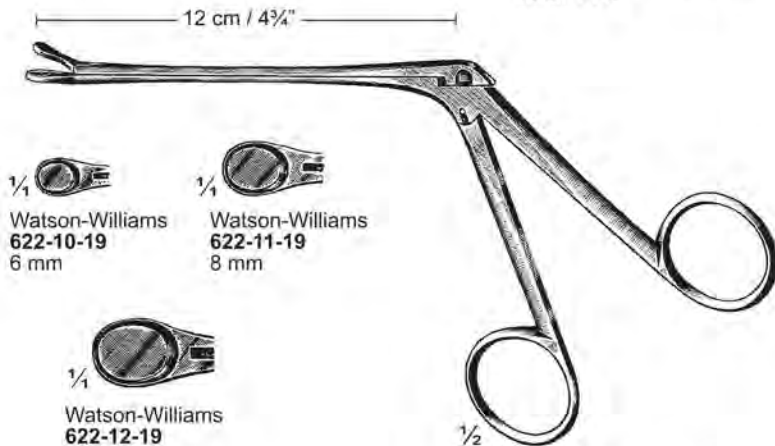

**622-08-19 To 622-12-19**  
19 cm / 7 1/2"



**Watson-Williams**  
**622-10-19**  
6 mm



**Watson-Williams**  
**622-11-19**  
8 mm



**Watson-Williams**  
**622-12-19**  
10 mm

**Siebbeinzangen  
Nasal Cutting Forceps  
Pincers éthmoïdales**

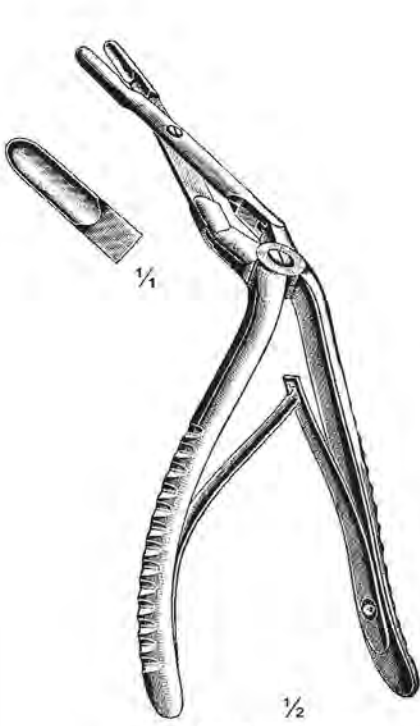

Middleton-Jansen  
623-01-19  
19 cm / 7½"





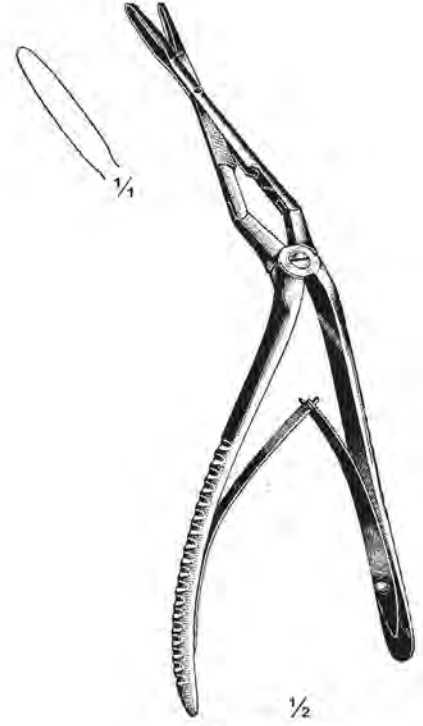

Middleton-Jansen  
623-02-19  
19 cm / 7½"







Middleton-Struycken  
623-03-19  
19 cm / 7½"



- |   |   |   |   |
|---|---|---|---|
|  |  |  |  |
| Hartmann<br>623-04-05<br>5 mm Ø   | Hartmann<br>623-05-07<br>7 mm Ø   | Hartmann<br>623-06-09<br>9 mm Ø   | Hartmann<br>623-07-11<br>11 mm Ø  |



- |   |   |   |   |
|---|---|---|---|
|  |  |  |  |
| Schmeden<br>623-08-05<br>5 mm   | Schmeden<br>623-09-07<br>7 mm   | Schmeden<br>623-10-08<br>8 mm   | Schmeden<br>623-11-09<br>9 mm   |

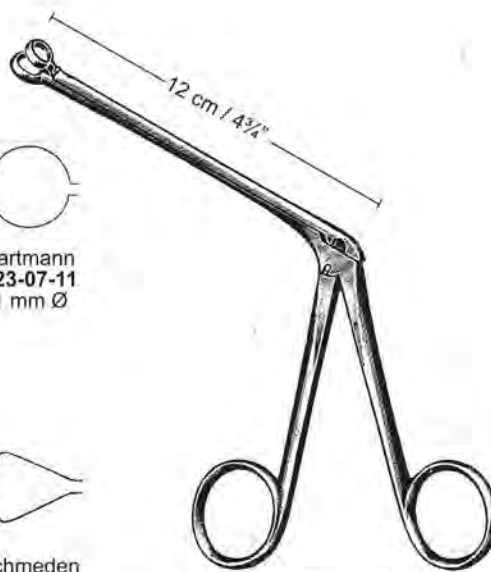

623-04-05 To 623-11-09  
19 cm / 7½"



Hajek-Claus  
623-12-20  
20 cm / 8"



**Siebbeinzangen  
Nasal Cutting Forceps  
Pincés éthmoïdales**

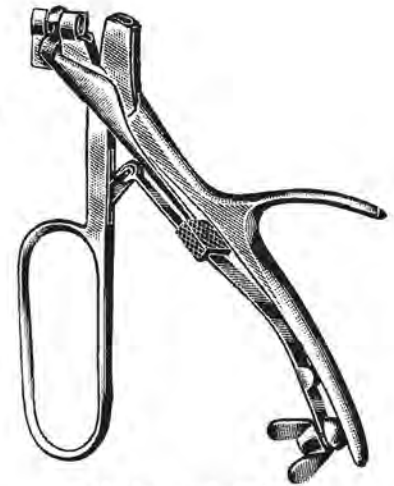

**624-01-04 To 624-17-11**  
Complete handle with  
interchangeable Shaft



Hartmann  
**624-01-04**  
4 X 8 mm



Hartmann  
**624-02-06**  
6 X 10 mm



Hartmann  
**624-03-06**  
6 X 14 mm



Gruenwald  
**624-04-02**  
2 X 11 mm



Cordes  
**624-05-03**  
3 mm



Cordes  
**624-06-03**  
3 mm



Ostrom  
**624-07-00**



Wagener  
**624-08-00**



Wagener  
**624-09-00**



Wagener  
**624-10-00**

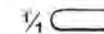

Myles  
**624-11-02**  
2.5 X 7 mm



Myles  
**624-12-03**  
3 X 8 mm



Myles  
**624-13-03**  
3.5 X 9 mm



Hartmann  
**624-14-05**  
5 mm Ø



Hartmann  
**624-15-07**  
7 mm Ø



Hartmann  
**624-16-09**  
9 mm Ø



Hartmann  
**624-17-11**  
11 mm Ø

**Septummesser  
Septum Knives  
Bistouris pour la cloison nasale**



Cottle  
625-01-15  
15 cm / 6"

Cottle  
625-02-15  
15 cm / 6"

Heymann  
625-03-14  
14 cm / 5½"

Fomon  
625-04-16  
16 cm / 6¼"

Joseph  
625-05-15  
15 cm / 6"

Converse  
625-06-16  
16 cm / 6¼"

Krieg  
625-07-15  
15 cm / 6"



625-10-16  
Sharp

625-11-16  
Sharp

625-12-16  
Sharp

625-13-16  
Sharp



625-14-16  
Blunt

625-15-16  
Blunt

625-16-16  
Blunt

625-17-16  
Blunt

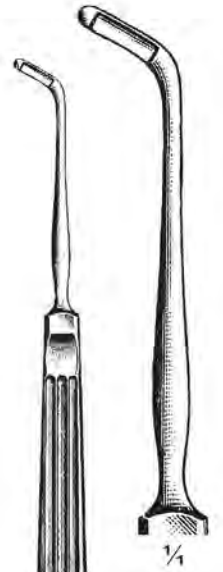

Joseph  
625-08-16  
16 cm / 6¼"

Joseph  
625-09-21  
21 cm / 8¼"

Joseph  
625-10-16 To 625-17-16  
16 cm / 6¼"

Joseph  
625-18-16  
16 cm / 6¼"

Septummesser  
Septum Knives  
Bistouris pour la cloison nasale



Bruenings  
626-01-16  
16 cm / 6¼"



Halle  
626-02-18  
18 cm / 7"



Ballenger  
626-03-14  
14 cm / 5½"



Freer  
626-04-15  
15 cm / 6"



Freer  
626-05-15  
15 cm / 6"



Freer  
626-06-16  
16 cm / 6¼"

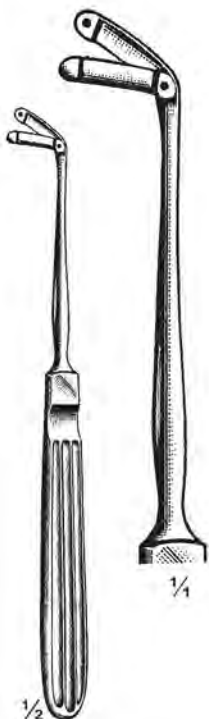

Maltz  
626-07-16  
16 cm / 6¼"



626-08-15 & 626-09-15  
15 cm / 6"

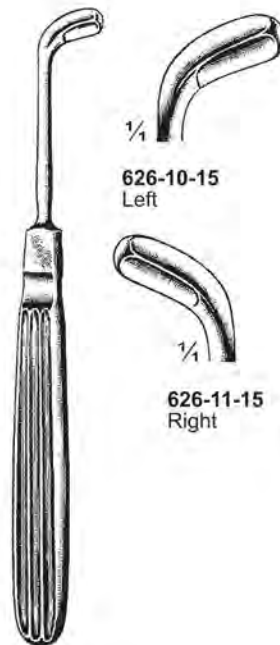

626-10-15 & 626-11-15  
15 cm / 6"

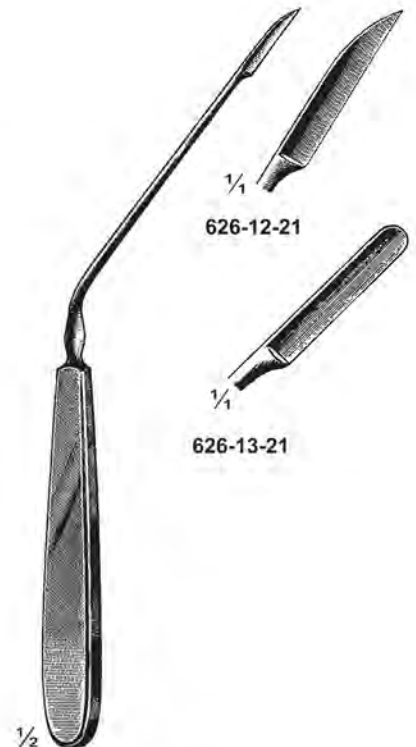

Flatau  
626-12-21 & 626-13-21  
21 cm / 8¼"



**Septummesser  
Septum Knives  
Bistouris pour la cloison nasale**

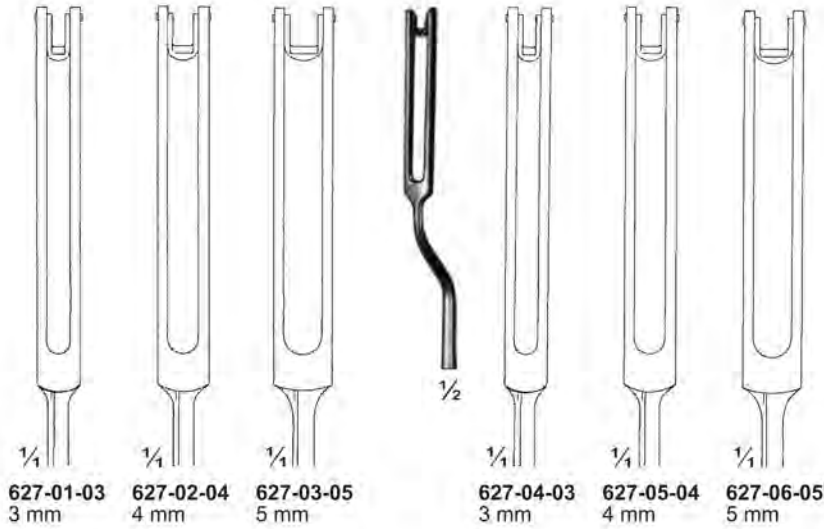

1/4      1/4      1/4      1/4      1/2      1/4      1/4      1/4  
**627-01-03**    **627-02-04**    **627-03-05**    **627-04-03**    **627-05-04**    **627-06-05**  
 3 mm          4 mm          5 mm          3 mm          4 mm          5 mm



1/2  
**Killian**  
**627-07-13**  
13 cm / 5 1/4"



1/2  
**Freer-Ingals**  
**627-08-17**  
17 cm / 6 3/4"

**Ballenger**  
**627-01-03 To 627-06-05**  
20 cm / 8"

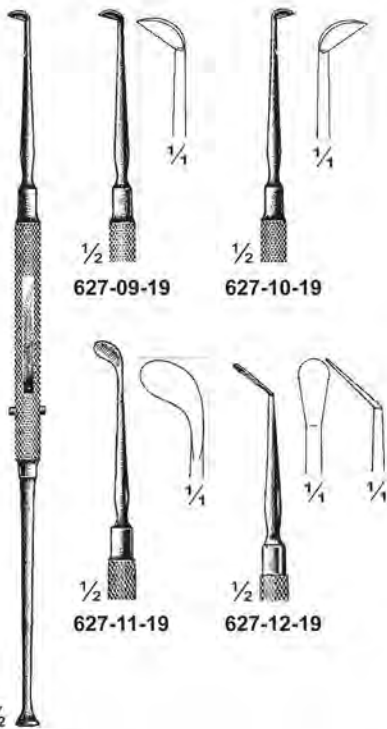

1/2  
**Freer**  
**627-09-19 To 627-12-19**  
19 cm / 7 1/2"



1/4      1/4  
Sharp  
1/2  
**Freer**  
**627-13-19**  
19 cm / 7 1/2"



1/4  
Sharp  
1/2  
**Freer**  
**627-14-19**  
19 cm / 7 1/2"



1/4      1/4  
Sharp  
1/2  
**Freer**  
**627-15-18**  
18 cm / 7"



1/4      1/4  
Sharp  
1/2  
**Freer**  
**627-16-20**  
20 cm / 8"

**Septum elevatorien  
Septum Elevators  
Élévateurs pour la closion nasale**

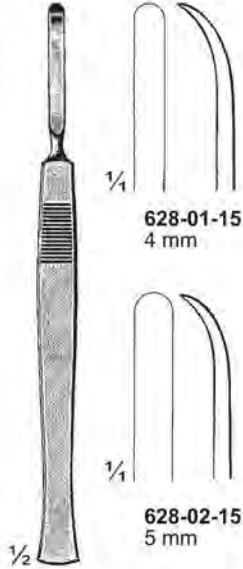

McKenty  
628-01-15 & 628-02-15  
15 cm / 6"



Halle  
628-03-16  
16.5 cm / 6 1/2"



Joseph  
628-04-16  
16 cm / 6 1/4"



Joseph  
628-05-16  
16 cm / 6 1/4"



Killian  
628-06-17  
17 cm / 6 3/4"  
Sharp



Killian  
628-07-17  
17 cm / 6 3/4"  
Blunt



Killian  
628-08-18  
18 cm / 7"

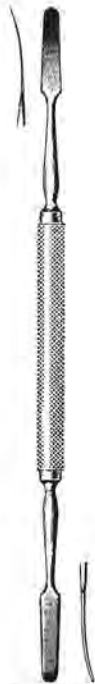

Killian  
628-09-18  
18 cm / 7"



Killian  
628-10-23  
23 cm / 9"



Hajek-Ballenger  
628-11-20  
20 cm / 8"



Kistner  
628-12-17 & 628-13-17  
17 cm / 6 3/4"



Pierce  
628-14-20  
20 cm / 8"

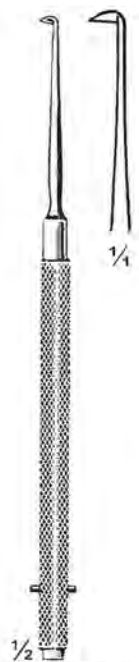

Freer-Ingals  
628-15-17  
17 cm / 6 3/4"

Septum elevator  
 Septum Elevators  
 Elévateurs pour la cloison nasale



Roger  
 629-01-19  
 19 cm / 7½"



Pennington  
 629-02-21  
 21 cm / 8¼"



Carter  
 629-03-21  
 21 cm / 8¼"



Howarth  
 629-04-21  
 21.5 cm / 8½"



McKenty  
 629-05-22  
 22 cm / 8¾"



Masing  
 629-06-21  
 21 cm / 8¼"

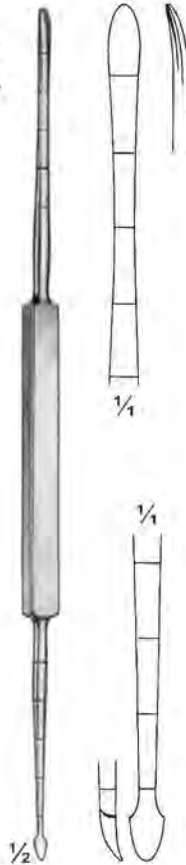

Cottle  
 629-07-21  
 21 cm / 8¼"



Cottle  
 629-08-22  
 22 cm / 8¾"

**Septumlevatorien  
Septum Elevators  
Élévateurs pour la clonion nasale**

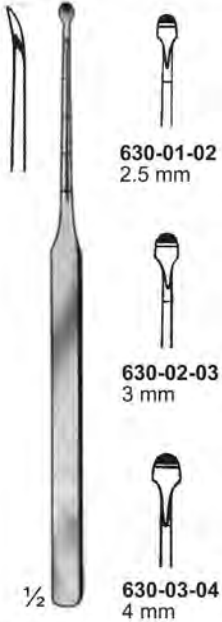

Cottle  
630-01-02 To 630-03-04  
16 cm / 6 1/4"



Cottle  
630-04-23  
23 cm / 9"



Joseph-Masing  
630-05-22  
22 cm / 8 3/4"



Lange  
630-06-23  
23 cm / 9"



630-07-21  
21 cm / 8 1/4"  
4 mm Ø

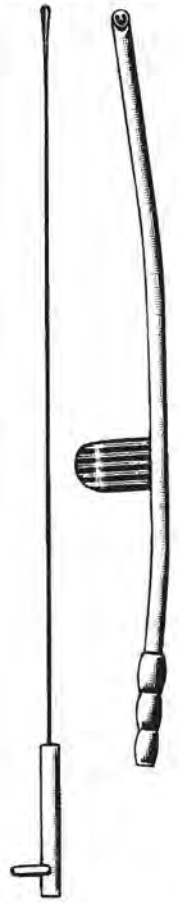

630-08-20  
20 cm / 8"  
4 mm



Yankauer  
630-09-18  
18 cm / 7"



630-10-18  
Sharp

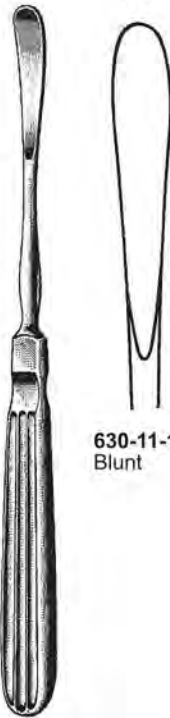

630-11-18  
Blunt



Converse  
630-12-18  
18 cm / 7"



Goldman  
630-13-17  
17 cm / 6 3/4"



Converse  
630-14-19  
19 cm / 7 1/4"

**Septum elevatorien**  
**Septum Elevators**  
**Élévateurs pour la cloison nasale**

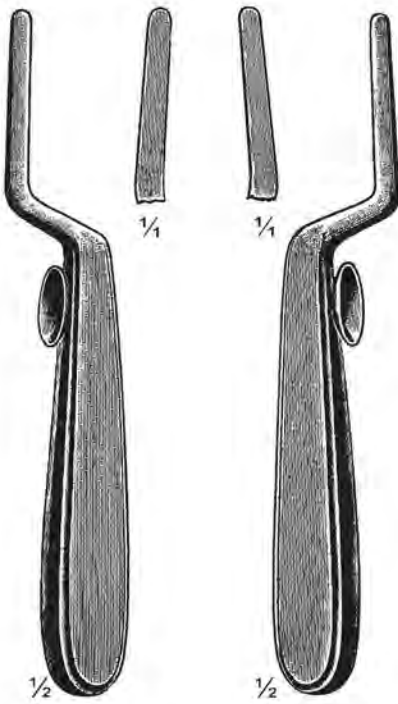

1/2  
 Killian  
**631-01-18**  
 18 cm / 7"  
 Left



1/2  
 Killian  
**631-02-18**  
 18 cm / 7"  
 Right



**631-03-22**  
 22 cm / 8 3/4"



1/2  
 Cottle  
**631-04-22**  
 22 cm / 8 3/4"



1/2  
 Cottle  
**631-05-23**  
 23 cm / 9"

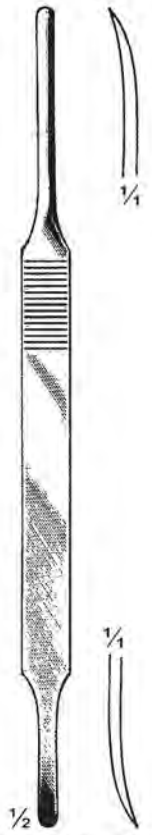

1/2  
 Cottle-McKenty  
**631-06-22**  
 22 cm / 8 3/4"



1/4



1/4

Cottle  
**631-07-00**  
 Bone crusher



1/4

Cottle  
**631-08-00**  
 Bone and cartilage  
 guide



1/4

**631-09-00**  
 Bone and cartilage  
 guide



**Tonsillenscheren  
Septum Scissors  
Ciseaux pour les amygdales**



Cottle  
632-01-19  
19 cm / 7 1/4"

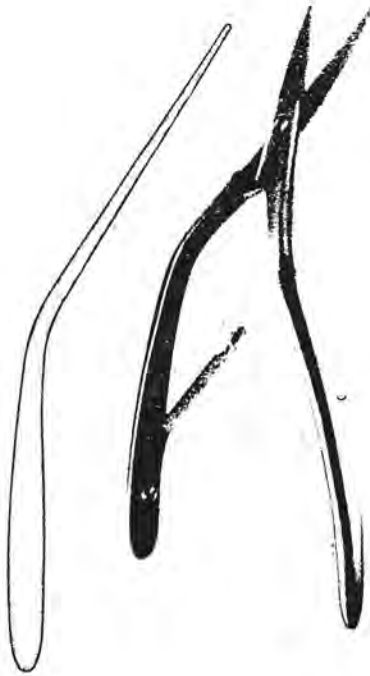

Cottle  
632-02-19  
19 cm / 7 1/4"



Muhling  
632-03-21  
21 cm / 8 1/4"

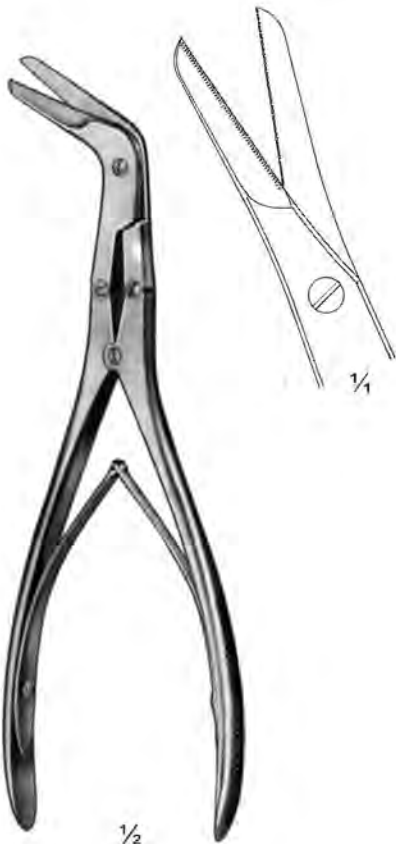

Killian  
632-04-21  
21 cm / 8 1/4"  
Both blades serrated



Caplan  
632-05-20  
20 cm / 8"  
Both blades serrated



Ruhin  
632-06-21  
21 cm / 8 1/4"  
Septum morselizer



**Nasenmeißel, Osteotome, Nasensägen**  
**Rhinoplastic Chisels, Osteotomes, Nasal Saws**  
**Ciseaux-burins nasaux, Ostéotomes, Scies nasales**



Freer  
633-01-16  
16 cm / 6 1/4"



Freer  
633-02-16  
16 cm / 6 1/4"



Freer  
633-03-17 4 mm  
633-04-17 6 mm  
17 cm / 6 3/4"



Ballenger  
633-05-17 4 mm  
633-06-17 6 mm  
17 cm / 6 3/4"



Killian  
633-07-16  
16 cm / 6 1/4"



Killian-Claus  
633-08-16  
16 cm / 6 1/4"



Freer  
633-09-19 & 633-10-19  
19 cm / 7 1/2"



Sewall  
633-11-20  
20 cm / 8"



Rubin  
633-12-10 To 633-14-14  
18 cm / 7"

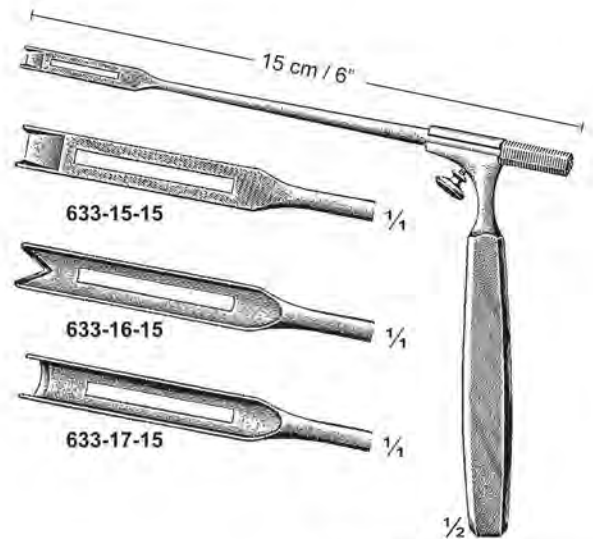
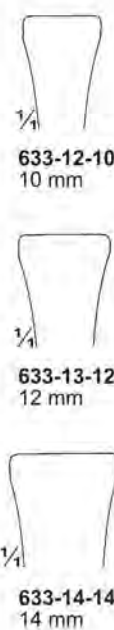

Metzenbaum  
633-15-15 To 633-17-15  
Handle size 11 cm / 4 1/4"  
633-18-00  
Complete with 1 Handle  
1 Chisel and 2 Gouges

**Nasenmeißel, Osteotome, Nasensägen**  
**Rhinoplastic Chisels, Osteotomes, Nasal Saws**  
**Ciseaux-burins nasaux, Ostéotomes, Scies nasales**

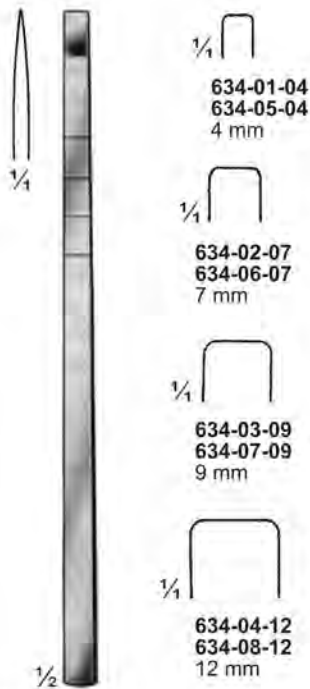

Cottle  
**634-01-04 To 634-04-12**  
 18 cm / 7"

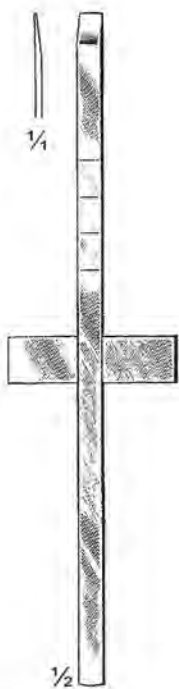

Cottle  
**634-05-04 To 634-08-12**  
 18 cm / 7"



Cottle  
**634-09-04 To 634-12-12**  
 18 cm / 7"

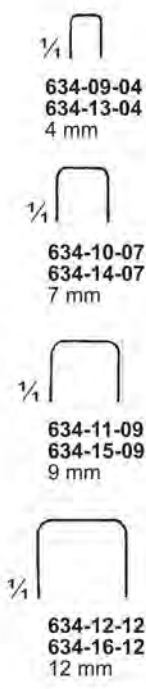

Cottle  
**634-13-04 To 634-16-12**  
 18 cm / 7"



Cottle  
**634-17-10**  
 20 cm / 8"

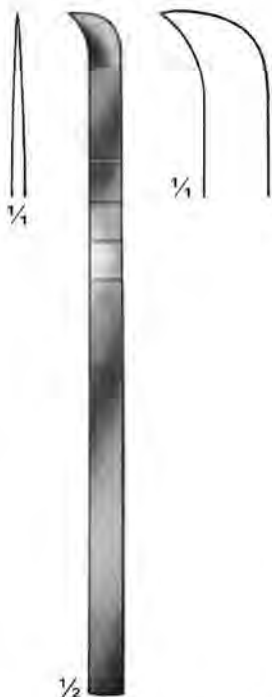

Cottle  
**634-18-18**  
 18 cm / 7"

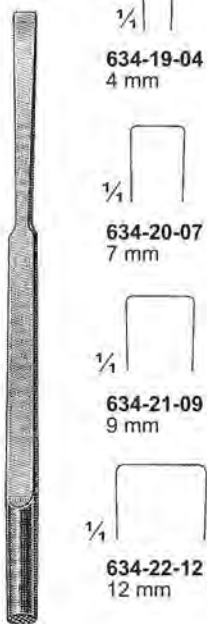

Cottle  
**634-19-04 To 634-22-12**  
 18 cm / 7"



Walter  
**634-23-03 & 634-24-05**  
 19 cm / 7½"

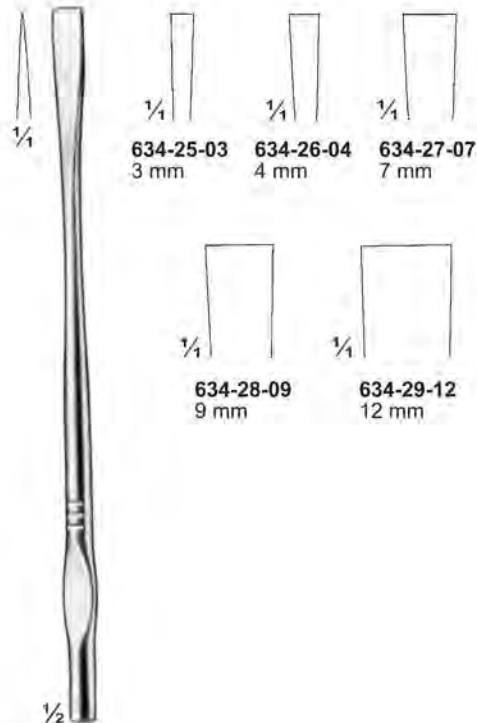

Walter  
**634-25-03 To 634-29-12**  
 19 cm / 7½"



**Nasenmeißel, Osteotome, Nasensägen**  
**Rhinoplastic Chisels, Osteotomes, Nasal Saws**  
**Ciseaux-burins nasaux, Ostéotomes, Scies nasales**

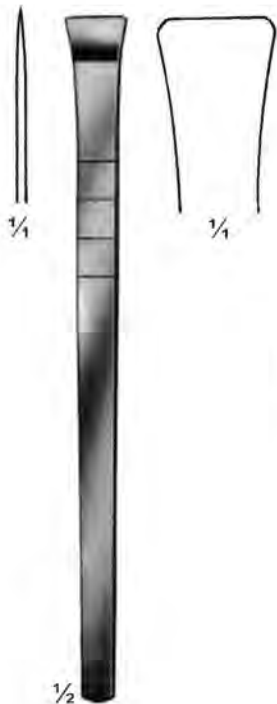

Cottle  
**635-01-18**  
 18 cm / 7"

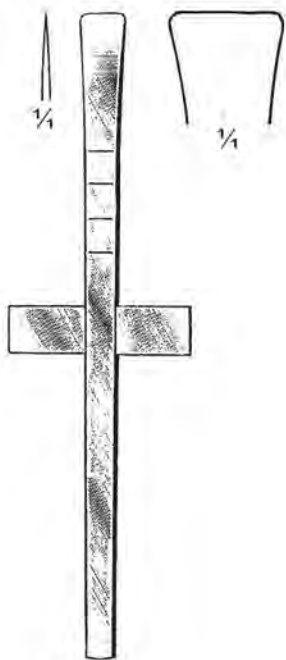

Cottle  
**635-02-18**  
 18 cm / 7"

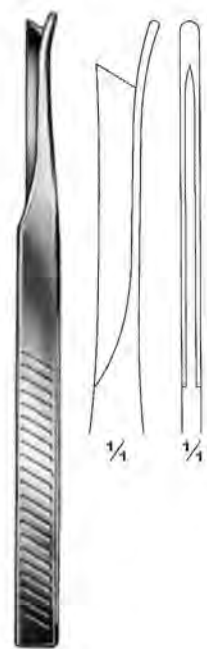

Silver  
**635-03-18**  
 18 cm / 7"

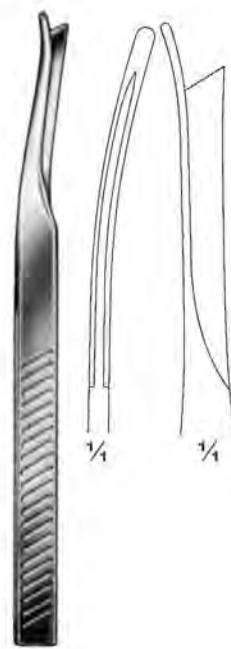

Silver  
**635-04-18**  
 18 cm / 7"



Silver  
**635-05-18**  
 18 cm / 7"

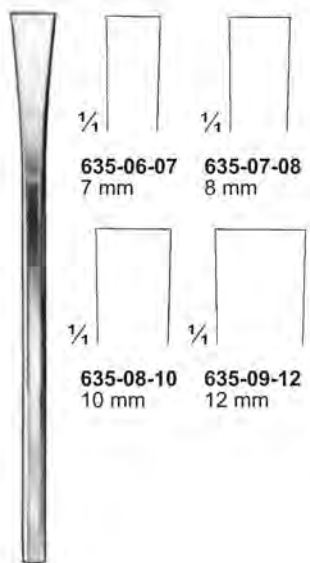

Sheehan  
**635-06-07 To 635-09-12**  
 17 cm / 6 3/4"

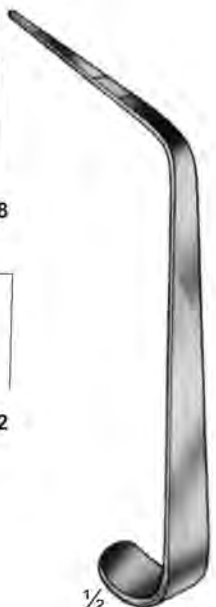

Cottle  
**635-10-40 To 635-13-70**  
 16 cm / 6 1/4"

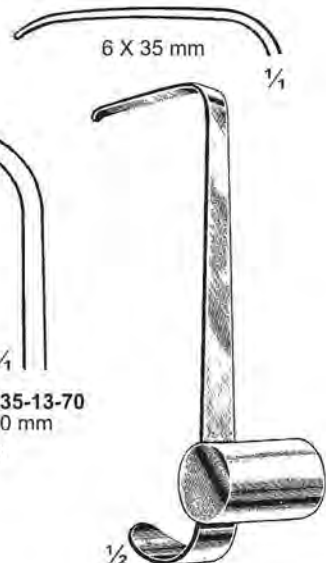
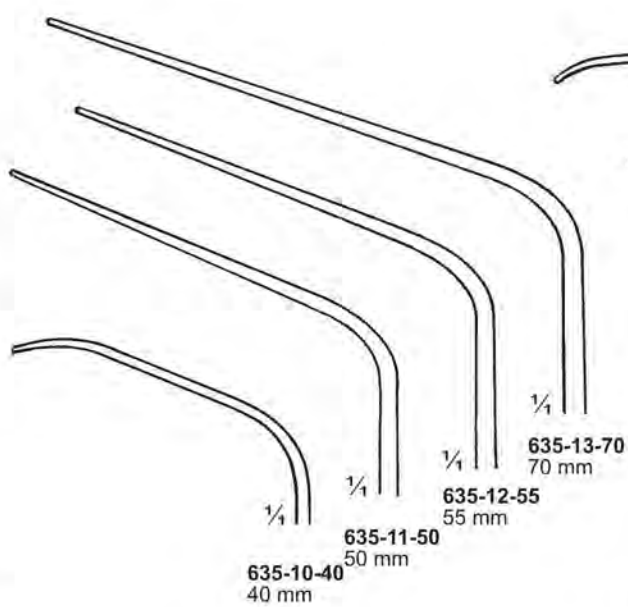

Cottle  
**635-14-13**  
 13 cm / 5 1/4"



**Nasenmeißel, Osteotome, Nasensägen**  
**Rhinoplastic Chisels, Osteotomes, Nasal Saws**  
**Ciseaux-burins nasaux, Ostéotomes, Scies nasales**

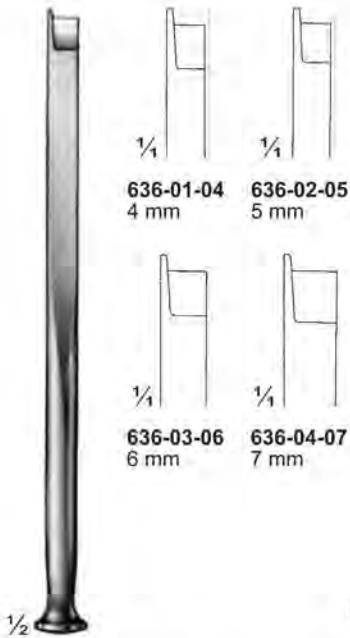

**Fomon**  
**636-01-04 To 636-04-07**  
 17 cm / 6 3/4"

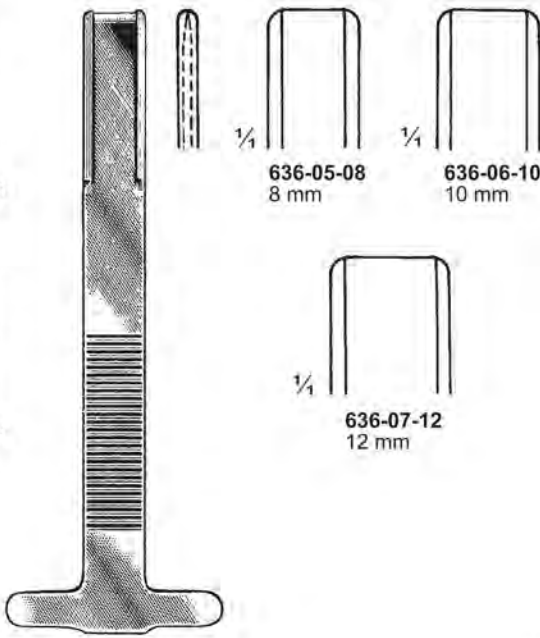

**Rubin**  
**636-05-08 To 636-07-12**  
 18 cm / 7"

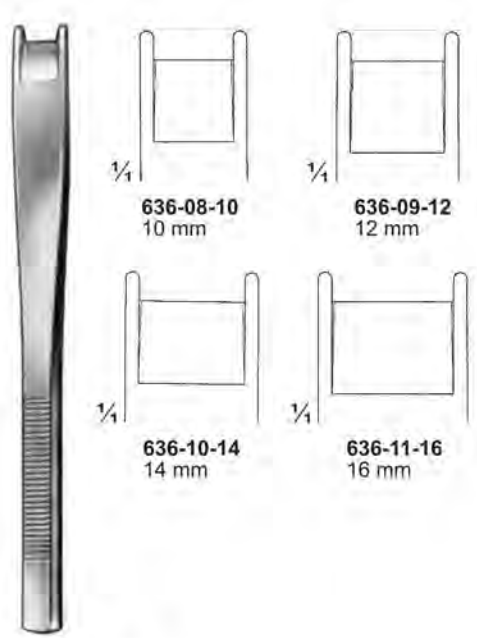

**Cinelli**  
**636-08-10 To 636-11-16**  
 18 cm / 7"

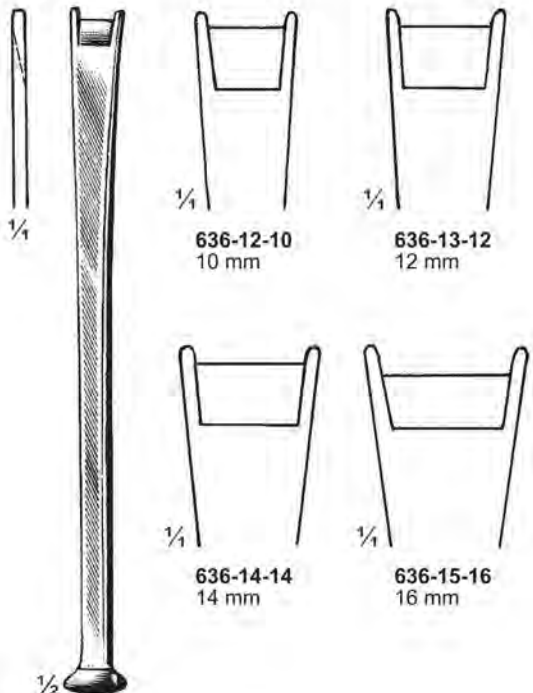

**Moberg**  
**636-12-10 To 636-15-16**  
 18 cm / 7"

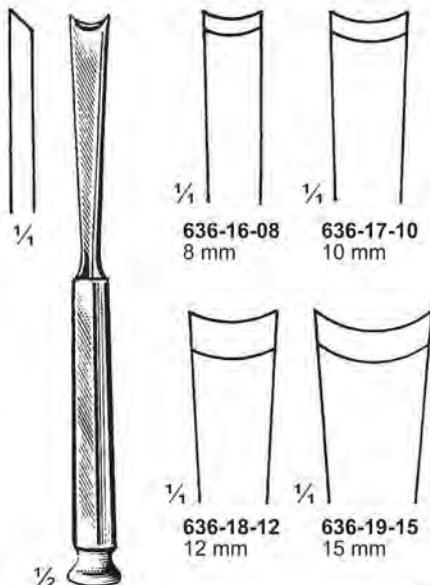

**McIndoe**  
**636-16-08 To 636-19-15**  
 16 cm / 6 1/4"

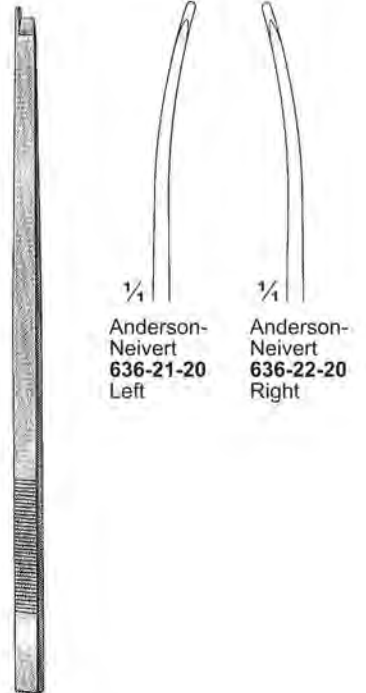

**Neivert**  
**636-20-20 To 636-22-20**  
 20 cm / 8"

**Nasenmeißel, Osteotome, Nasensägen**  
**Rhinoplastic Chisels, Osteotomes, Nasal Saws**  
**Ciseaux-burins nasaux, Ostéotomes, Scies nasales**



1/2  
**Fomon**  
**637-01-17**  
 17 cm / 6 3/4"

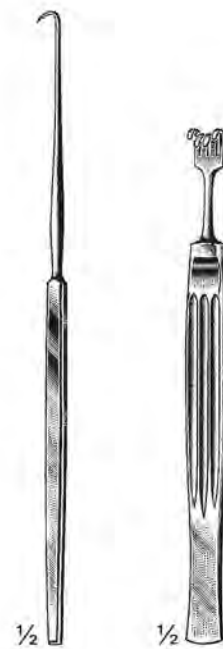

1/2  
**Cottle**  
**637-02-16**  
 16 cm / 6 1/4"

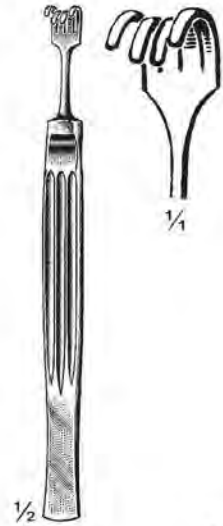

1/2  
**Cottle**  
**637-03-14**  
 14 cm / 5 1/2"



1/2  
**Cottle**  
**637-04-14 To 637-07-14**  
 14 cm / 5 1/2"

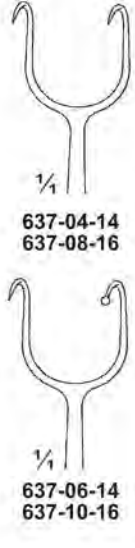

1/4  
**637-04-14**  
**637-08-16**

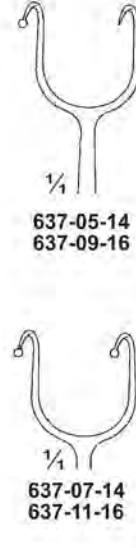

1/4  
**637-05-14**  
**637-09-16**



1/4  
**637-06-14**  
**637-10-16**



1/4  
**637-07-14**  
**637-11-16**



1/2  
**Fomon**  
**637-08-16 To 637-11-16**  
 16 cm / 6 1/4"

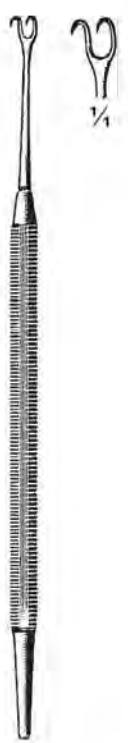

1/2  
**Cottle**  
**637-12-15**  
 15 cm / 6"



**Masing**  
**637-13-20**  
 20 cm / 8"



1/2  
**Neivert**  
**637-14-19**  
 19.5 cm / 7 3/4"



1/2  
**Cottle-Neivert**  
**637-15-20**  
 20 cm / 8"



1/2  
**Cottle**  
**637-16-14**  
 14 cm / 5 1/2"

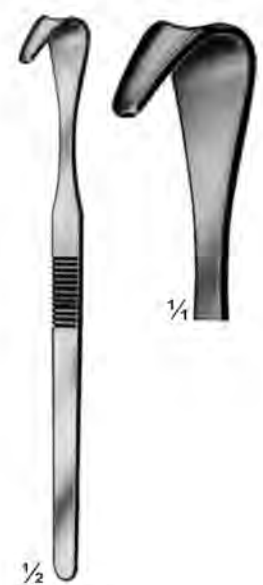

1/2  
**Cottle**  
**637-17-15**  
 15 cm / 6"

Nasenmeißel, Osteotome, Nasensägen  
 Rhinoplastic Chisels, Osteotomes, Nasal Saws  
 Ciseaux-burins nasaux, Ostéotomes, Scies nasales



Joseph  
638-01-15  
15 cm / 6"



638-02-15 To 638-04-15  
15 cm / 6"



638-02-15



638-03-15



638-04-15



Freer  
638-05-15  
15 cm / 6"

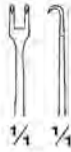

Joseph  
638-06-02 To 638-09-10  
16 cm / 6 1/4"



638-06-02  
2 mm



638-07-05  
5 mm



638-08-07  
7 mm



638-09-10  
10 mm



Freer  
638-10-17  
17 cm / 6 3/4"



Kilner  
638-11-10  
10 cm / 4"



Converse  
638-12-12  
12 cm / 4 3/4"



Aufricht  
638-13-13  
13.5 cm / 5 1/4"

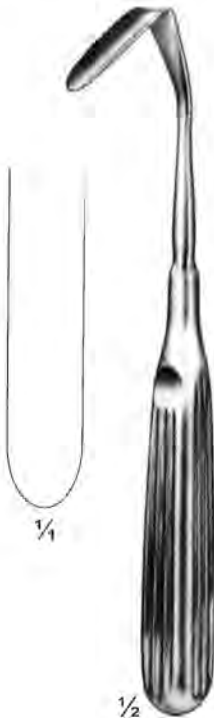

Aufricht  
638-14-19  
19 cm / 7 1/2"



Yankauer  
638-15-17 To 638-23-17  
17 cm / 6 3/4"  
Septum suture needles



638-15-17



638-16-17



638-17-17



638-18-17



638-19-17



638-20-17



638-21-17



638-22-17



638-23-17



Nasenmeißel, Osteotome, Nasensägen  
 Rhinoplastic Chisels, Osteotomes, Nasal Saws  
 Ciseaux-burins nasaux, Ostéotomes, Scies nasales



639-01-16



639-02-16

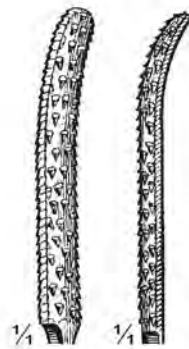

639-03-16

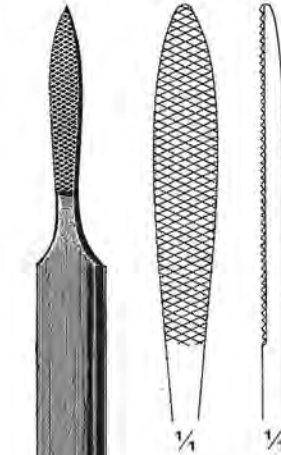

Joseph  
 639-04-16  
 16 cm / 6 1/4"

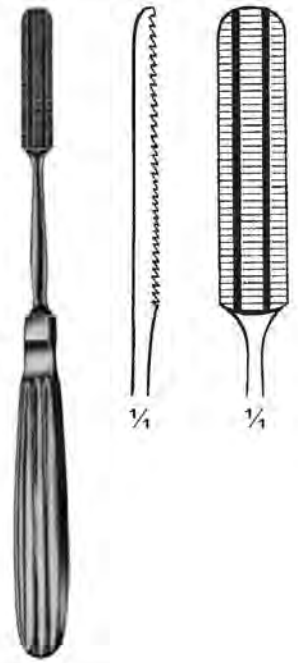

Maltz  
 639-05-18  
 18 cm / 7"

Gallaher  
 639-01-16 To 639-03-16  
 16 cm / 6 1/4"



Lewis  
 639-06-18 & 639-07-18  
 18 cm / 7"



639-06-18  
 Fine



639-07-18  
 Coarse

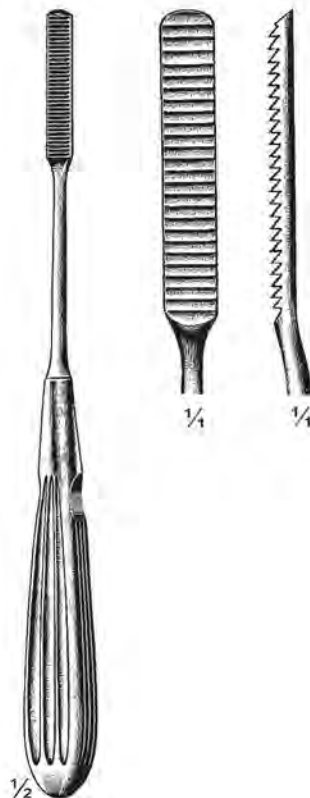

Cottle  
 639-08-21  
 21 cm / 8 1/4"



Aufricht  
 639-09-21 To 639-11-21  
 21 cm / 8 1/4"



639-09-21

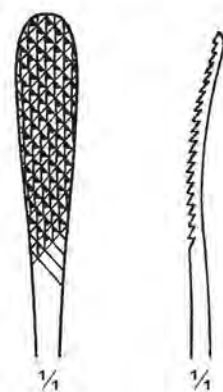

639-10-21

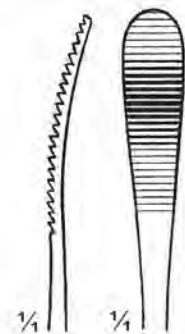

639-11-21



**Nasenmeißel, Osteotome, Nasensägen**  
**Rhinoplastic Chisels, Osteotomes, Nasal Saws**  
**Ciseaux-burins nasaux, Ostéotomes, Scies nasales**

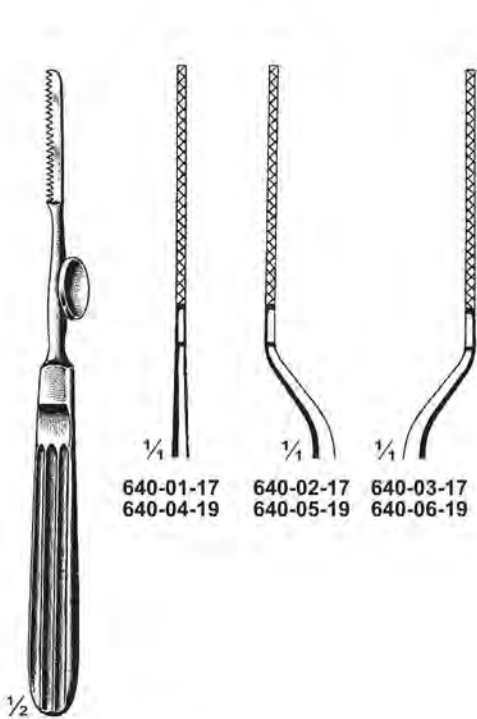

640-01-17 640-02-17 640-03-17  
 640-04-19 640-05-19 640-06-19

Joseph  
 640-01-17 To 640-03-17  
 17 cm / 6¾"



Joseph  
 640-04-19 To 640-06-19  
 19 cm / 7½"



¼  
 640-07-18



Wiener  
 640-07-18 & 640-08-18  
 18 cm / 7"



¼  
 640-08-18



Joseph  
 640-09-17  
 17 cm / 6¾"



½  
 Joseph  
 640-10-17  
 17 cm / 6¾"



½  
 Joseph  
 640-11-17  
 17 cm / 6¾"

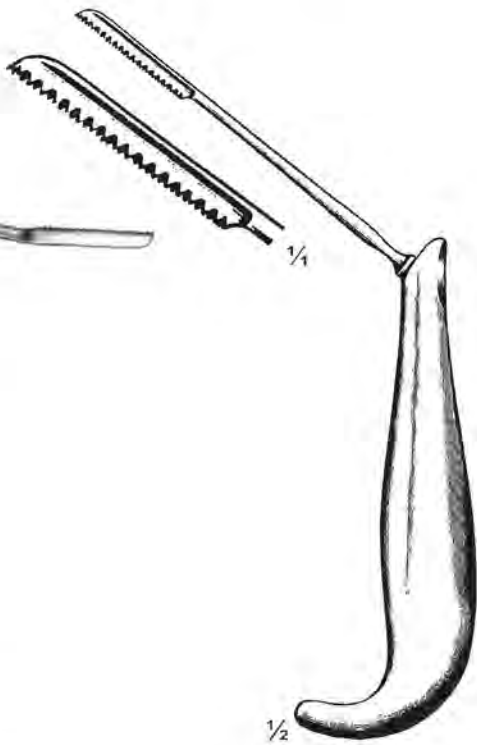

¼  
 Mowlem  
 640-12-21  
 21 cm / 8¼"



Masing  
 640-13-21  
 21 cm / 8¼"



Masing  
 640-14-21  
 21 cm / 8¼"



**Nasenmeißel, Osteotome, Nasensägen**  
**Rhinoplastic Chisels, Osteotomes, Nasal Saws**  
**Ciseaux-burins nasaux, Ostéotomes, Scies nasales**



Fomon  
**641-01-21**  
 21 cm / 8 1/4"



1/4



1/4



1/4



Converse  
**641-02-18**  
 18.5 cm / 7 1/4"



1/4



1/2



1/2



1/2

Fomon  
**641-03-20 To 641-07-20**  
 20 cm / 8"  
 With tungsten carbide inserts



**641-03-20**



**641-04-20**



**641-05-20**

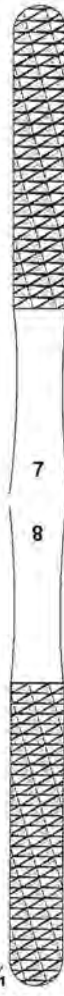

**641-06-20**

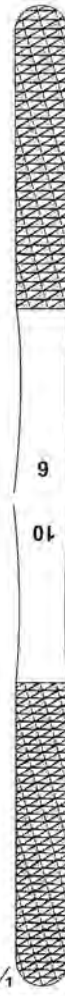

**641-07-20**

**Nasenmeißel, Osteotome, Nasensägen**  
**Rhinoplastic Chisels, Osteotomes, Nasal Saws**  
**Ciseaux-burins nasaux, Ostéotomes, Scies nasales**



Cottle  
**642-01-00**  
 Complete consisting:  
 1 Handle  
 2 Saw blades  
 1 Nutt and key



Joseph  
**642-02-15**  
 15 cm / 6"

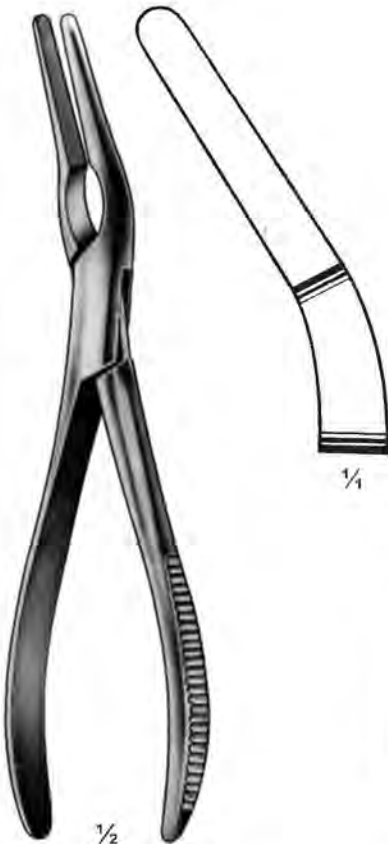

Asch  
**642-03-22**  
 22 cm / 8¾"



Rubin  
**642-04-21**  
 21 cm / 8¼"



Kressner  
**642-05-02 To 642-07-05**  
 21 cm / 8¼"

**642-05-02**  
 2.5 X 60 mm

**642-06-04**  
 4 X 70 mm

**642-07-05**  
 5 X 75 mm

**Nasenmeißel, Osteotome, Nasensägen**  
**Rhinoplastic Chisels, Osteotomes, Nasal Saws**  
**Ciseaux-burins nasaux, Ostéotomes, Scies nasales**



Cottle-Walsham  
**643-01-21**  
 21 cm / 8 1/4"



**643-02-23**  
 Right



**643-03-23**  
 Left

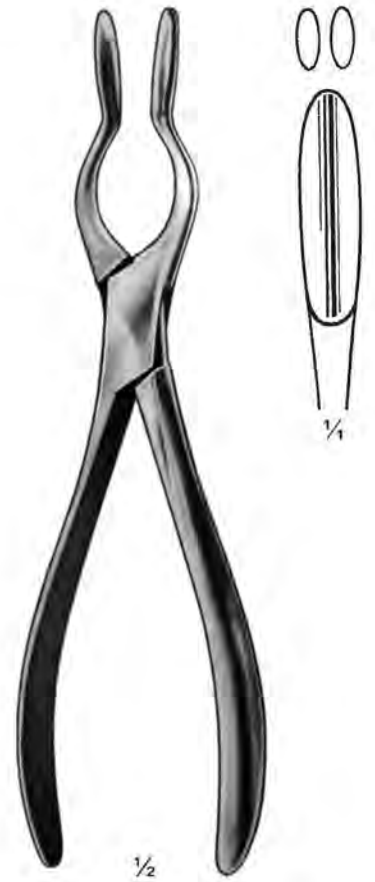

Walsham (Universal)  
**643-04-23**  
 23 cm / 9"



Tschoepe  
**643-05-19**  
 19 cm / 7 1/2"

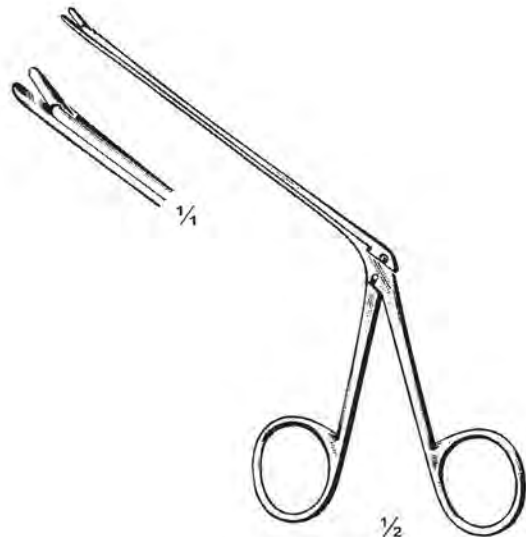

Cottle-Masing  
**643-06-06** Shaft 6 cm / 2 1/4"  
**643-07-09** Shaft 9 cm / 3 1/2"  
 16 cm / 6 1/4"



**Nasenmeißel, Osteotome, Nasensägen**  
**Rhinoplastic Chisels, Osteotomes, Nasal Saws**  
**Ciseaux-burins nasaux, Ostéotomes, Scies nasales**



**644-01-07**  
7.5 cm / 3"



Masing  
**644-02-08**  
8.5 cm / 3¼"



Ogura  
**644-03-11**  
11 cm / 4¼"



Cottle  
**644-04-11**  
11 cm / 4¼"



**644-05-10**  
10 cm / 4"



Fox  
**644-06-13** 13 cm / 5¼"  
**644-07-15** 15 cm / 6"  
3 X 3 Teeth



Fox  
**644-08-13**  
13 cm / 5¼"  
3 X 3 Teeth



Fox  
**644-09-13** 13 cm / 5¼"  
**644-10-15** 15 cm / 6"  
3 X 3 Teeth



Fox  
**644-11-15**  
15 cm / 6"  
3 X 3 Teeth



Hinderer  
**644-12-13**  
13 cm / 5¼"  
2 X 2 Teeth



Cottle  
**644-13-15**  
15 cm / 6"



Cottle  
**644-14-14**  
14 cm / 5½"



Guillen  
**644-15-12**  
12 cm / 4¾"

**Tonsillenscheren**  
**Tonsil Scissors**  
**Ciseaux pour les amygdales**



Fox  
**645-01-15**  
 15 cm / 6"



Littler  
**645-02-12**  
 12 cm / 4 3/4"

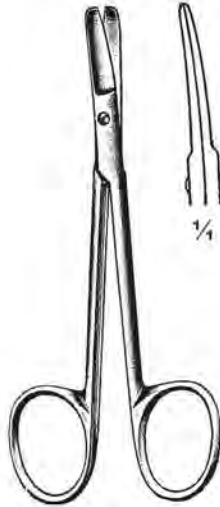

Cottle (Bulldog)  
**645-03-11**  
 11.5 cm / 4 1/2"



Converse  
**645-04-13**  
 13.5 cm / 5 1/4"



Castanares  
**645-05-16**  
 16 cm / 6 1/4"



McIndoe  
**645-06-19**  
 19 cm / 7 1/2"

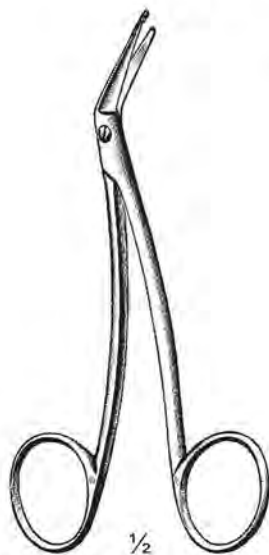

Taylor  
**645-07-14**  
 14 cm / 5 1/2"



Cottle  
**645-08-16**  
 16 cm / 6 1/4"

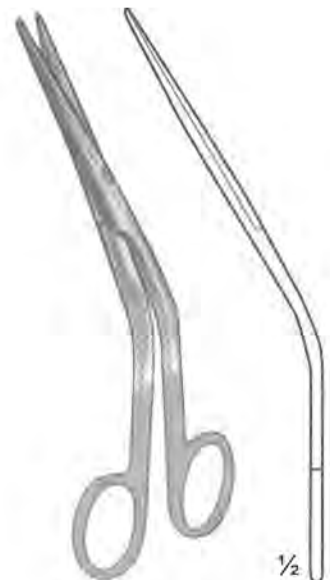

Cottle  
**645-09-16**  
 16 cm / 6 1/4"  
 With Tungsten  
 carbide inserts

**Tonsillenscheren  
Tonsil Scissors  
Ciseaux pour les amygdales**

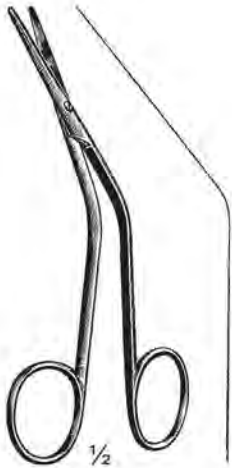

Fomon  
**646-01-13**  
13 cm / 5 1/8"



Fomon  
**646-02-13**  
13 cm / 5 1/8"

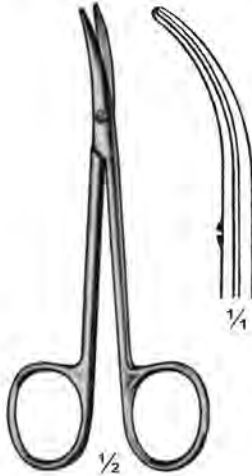

Fomon  
**646-03-12**  
12.5 cm / 5"



Fomon  
**646-04-12**  
12.5 cm / 5"



Cinelli  
**646-05-11**  
11 cm / 4 1/4"



Aufricht  
**646-06-14**  
14 cm / 5 1/2"

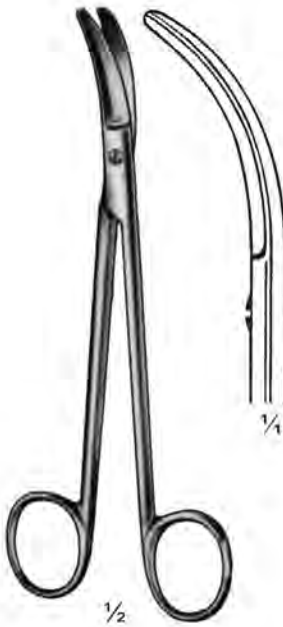

Joseph  
**646-07-16**  
16.5 cm / 6 1/2"

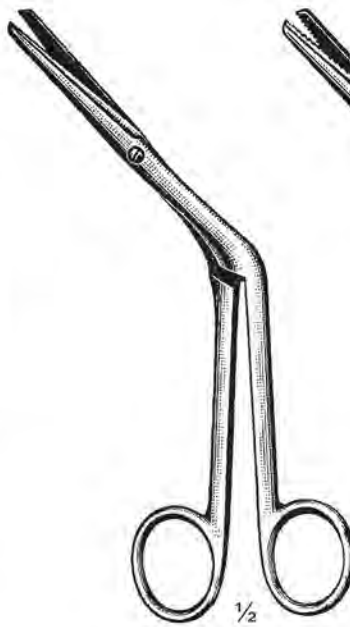

Heymann  
**646-08-17**  
17 cm / 6 3/4"

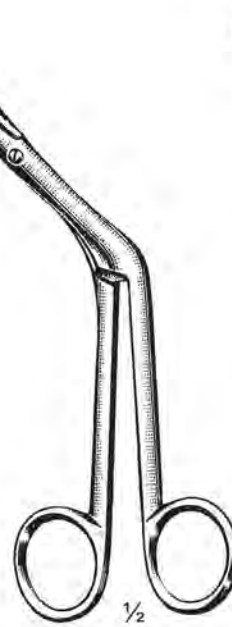

Heymann  
**646-09-17**  
17 cm / 6 3/4"  
Serrated blades



Seiler  
**646-10-17**  
17 cm / 6 3/4"

**Tonsillenscheren  
Tonsil Scissors  
Ciseaux pour les amygdales**



1/2  
Quisling  
647-01-17  
17 cm / 6 3/4"



300 g  
Guillen  
647-02-300  
24 cm / 9 1/2"



300 g  
Cottle  
647-03-300  
19 cm / 7 1/2"



1/2  
Dingman  
647-04-15  
15 cm / 6"  
Left



1/2  
Dingman  
647-05-15  
15 cm / 6"  
Right



1/2  
Coakley  
647-17-06 To 647-11-17  
17 cm / 6 3/4"



1/4  
647-06-17  
647-12-19



1/4  
647-07-17  
647-13-19



1/4  
647-08-17  
647-14-19



1/4  
647-09-17  
647-15-19



1/4  
647-10-17  
647-16-19



1/4  
647-11-17  
647-17-19



Coakley  
647-12-19 To 647-17-19  
19 cm / 7 1/2"



Faulkner  
647-18-21  
21 cm / 8 1/4"



Pratt  
647-19-21  
21 cm / 8 1/4"



Ringmesser  
Adenoid Curettes  
Couteaux à végétations adénoïdales



1/2

Beckmann  
648-01-01 To 648-06-06  
22 cm / 8 3/4"



1/4

648-01-01  
648-07-01



1/4

648-02-02  
648-08-02



1/4

648-03-03  
648-09-03



1/4

648-04-04  
648-10-04



1/4

648-05-05  
648-11-05



1/4

648-06-06  
648-12-06



1/2

Beckmann  
648-07-01 To 648-12-06  
22 cm / 8 3/4"



1/2

Beckmann  
648-13-01 To 648-17-05  
22 cm / 8 3/4"



1/4

648-13-01



1/4

648-14-02



1/4

648-15-03



1/4

648-16-04



1/4

648-17-05

**Ringmesser  
Adenoid Cures  
Couteaux à végétations adénoïdales**



$\frac{1}{2}$   
St. Clair-Thomson  
649-01-01 To 649-04-04  
21 cm / 8 $\frac{1}{4}$ "



$\frac{1}{4}$   
649-01-01



$\frac{1}{4}$   
649-02-02



$\frac{1}{4}$   
649-03-03



$\frac{1}{4}$   
649-04-04

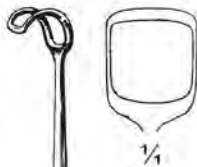

$\frac{1}{2}$   
Ingersoll  
649-05-21  
21.5 cm / 8 $\frac{1}{2}$ "



$\frac{1}{2}$   
Vogel  
649-06-21  
21.5 cm / 8 $\frac{1}{2}$ "

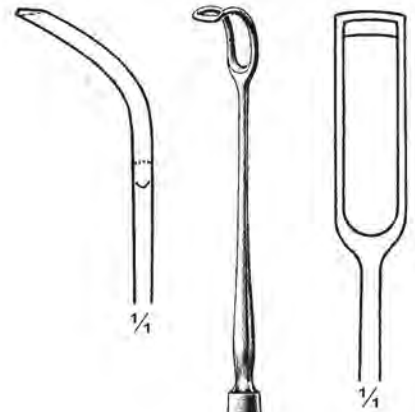

$\frac{1}{2}$   
Meddleton  
649-07-22  
22 cm / 8 $\frac{3}{4}$ "

**Ringmesser  
Adenoid Currettes  
Couteaux à végétations adénoïdales**

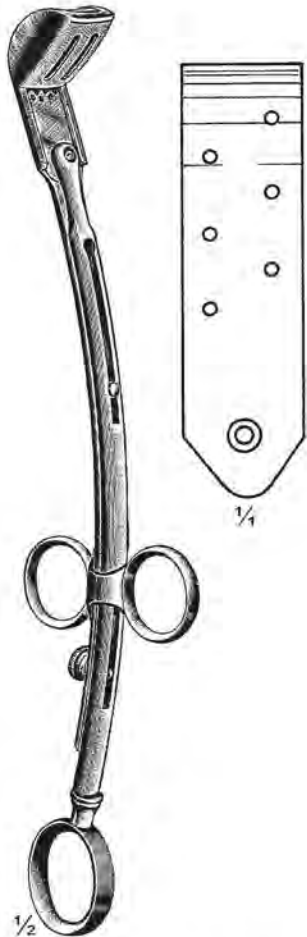
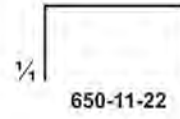
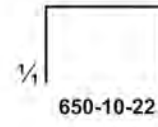
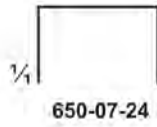
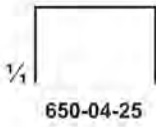
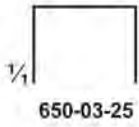
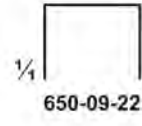
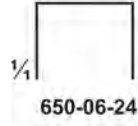
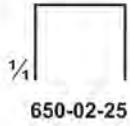

**La Force**  
650-01-25 To 650-05-25  
25 cm / 10"

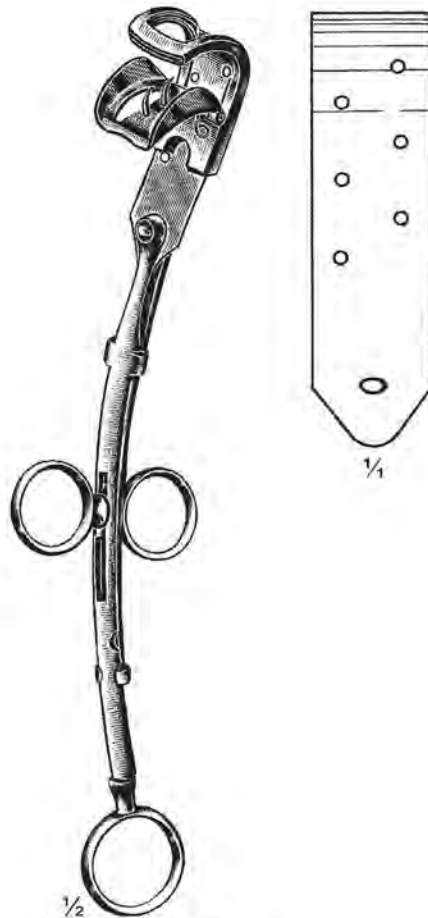

**La Force-Stevenson**  
650-06-24 To 650-08-24  
24 cm / 9½"

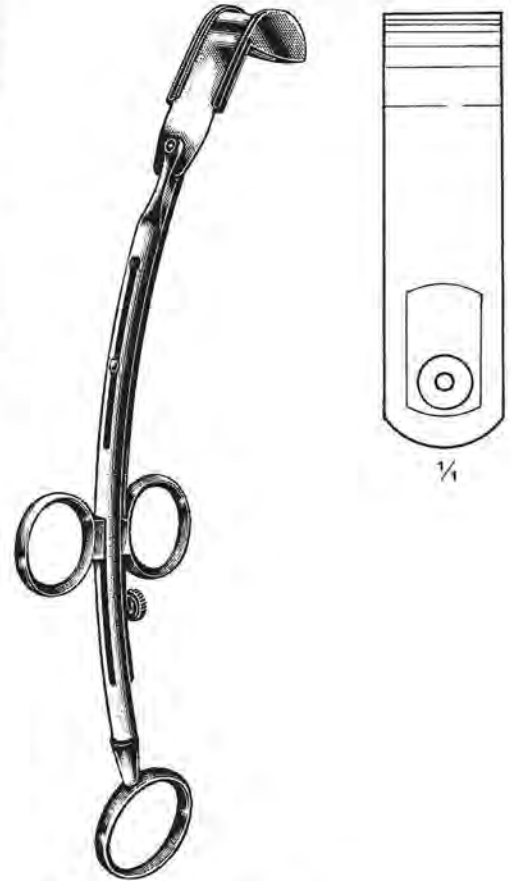

**Shambaugh**  
650-09-22 To 650-11-22  
22 cm / 8¾"

Ringmesser  
Adenoid Currettes  
Couteaux à végétations adénoïdales



Barnhill  
651-01-01 To 651-05-05  
22 cm / 8 3/4"



1/4  
651-01-01

1/4  
651-02-02

1/4  
651-03-03



1/4  
651-04-04



1/4  
651-05-05



Stubbs  
651-06-01 To 651-09-04  
22 cm / 8 3/4"



1/4  
651-06-01



1/4  
651-07-02



1/4  
651-08-03



1/4  
651-09-04



Moure  
651-10-01 To 651-13-04  
22 cm / 8 3/4"



1/4  
651-10-01



1/4  
651-11-02



1/4  
651-12-03



1/4  
651-13-04

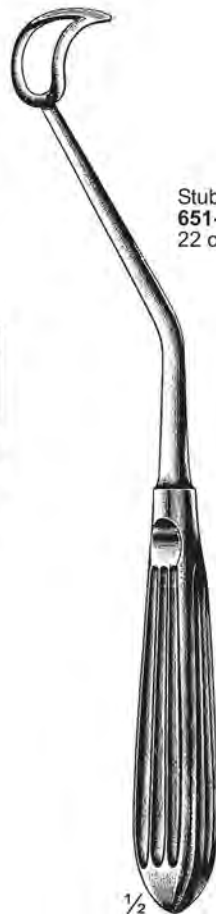

651-14 To 651-18  
24 cm / 9 1/2"



1/4  
651-14-01



1/4  
651-15-02



1/4  
651-16-03



1/4  
651-17-04



1/4  
651-18-05

**Ringmesser  
Adenoid Curettes  
Couteaux à végétations adénoïdales**



Shambaugh (Negus)  
652-01-01 To 652-06-06  
20 cm / 8"



652-01-01



652-02-02



652-03-03



652-04-04



652-05-05



652-06-06



Eicken  
652-07-03  
15 cm / 6"

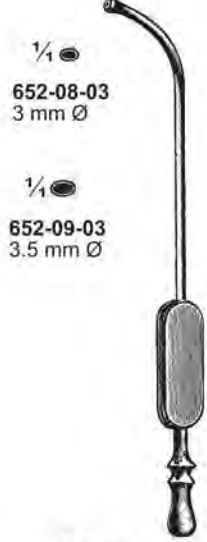

Killian  
652-08-03 & 652-09-03  
15 cm / 6"

652-09-03  
3.5 mm Ø



Van Alyea  
652-10-02  
15 cm / 6"  
2 mm Ø



Van Alyea  
652-11-02  
15 cm / 6"  
2 mm Ø



Van Alyea  
652-12-01  
12 cm / 4 3/4"  
1.5 mm Ø



Van Alyea  
652-13-01  
12 cm / 4 3/4"  
1.5 mm Ø



Van Alyea  
652-14-01  
12 cm / 4 3/4"  
1.5 mm Ø

# Katheter Catheters Catheters

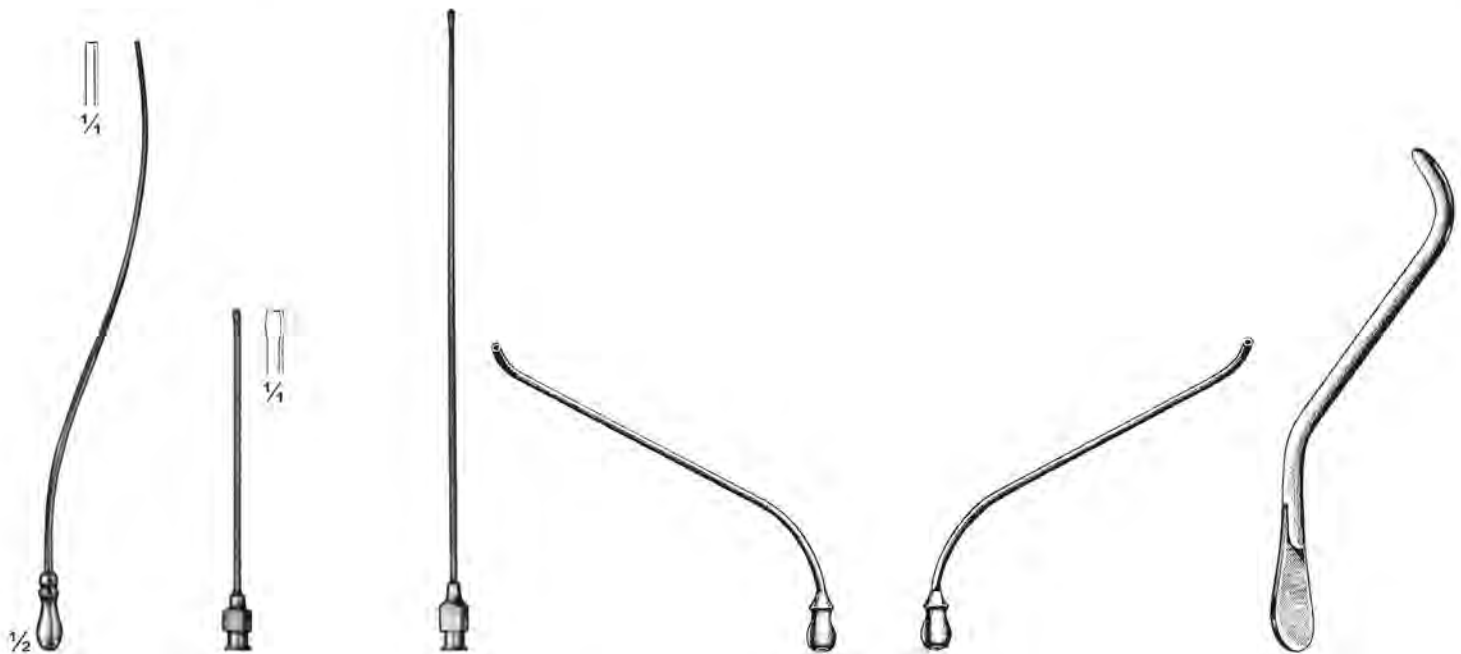

**Killian**  
653-01-17  
17 cm / 6¾"

**Hajek**  
653-02-01 1.5 mm Ø  
653-03-02 2.0 mm Ø  
17 cm / 6¾"

**Myles**  
653-04-01 9 cm / 3½"  
653-05-01 11.5 cm / 4½"  
1.8 mm Ø

**Hartmann**  
653-06-02 12 cm / 4¾"  
2 mm Ø

**Hartmann**  
653-07-02 12 cm / 4¾"  
2 mm Ø

**Ritter-Halle**  
653-08-02 2.5 mm Ø  
653-09-03 3.0 mm Ø  
653-10-04 4.0 mm Ø  
16 cm / 6¼"



**Guillen**  
653-11-20  
20 cm / 8"

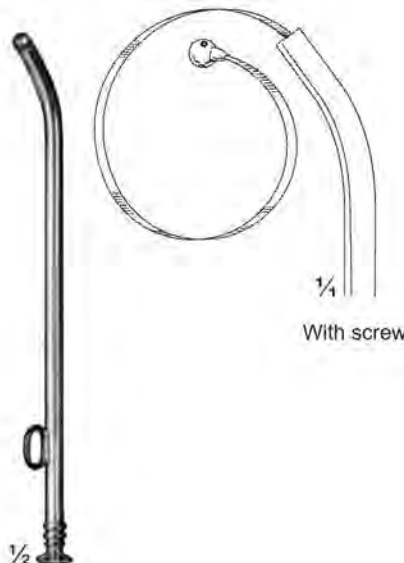

**Bellocq**  
653-12-14  
14 cm / 5½"

With screw



**Siebenmann**  
653-13 To 653-22  
15 cm / 6"



653-13-01 1.5 mm Ø  
653-14-01 1.7 mm Ø  
653-15-02 2.0 mm Ø  
653-16-02 2.5 mm Ø  
653-17-03 3.0 mm Ø



653-18-01 1.5 mm Ø  
653-19-01 1.7 mm Ø  
653-20-02 2.0 mm Ø  
653-21-02 2.5 mm Ø  
653-22-03 3.0 mm Ø







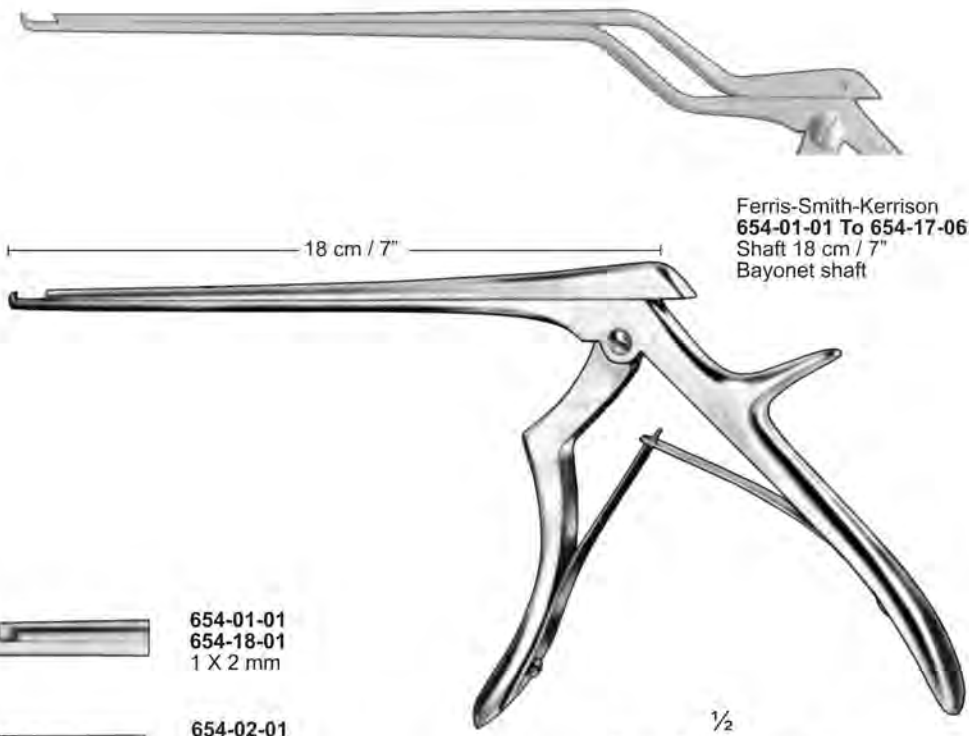



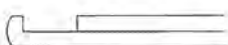

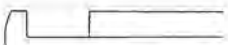
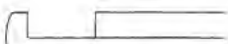

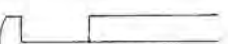
653-23-02  
11 cm / 4¼"  
2 mm Ø

**Keilbeinstanzen  
Punches  
Pinces emporte-pièces pour sinus sphéroïdal**

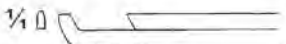
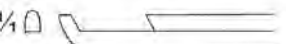

Ferris-Smith-Kerrison  
654-01-01 To 654-17-06  
Shaft 18 cm / 7"  
Bayonet shaft

¼ ∅		654-01-01 654-18-01 1 X 2 mm			
¼ ∅		654-02-01 654-19-01 1 X 2 mm			
¼ ∅		654-03-02 654-20-02 2 X 2 mm			
¼ ∅		654-04-02 654-21-02 2 X 2 mm			
¼ ∅		654-05-03 654-22-03 3 X 3 mm			
¼ ∅		654-06-04 654-23-04 4 X 3 mm			
¼ ∅		654-07-04 654-24-04 4 X 3 mm			
¼ ∅		654-08-05 654-25-05 5 X 3 mm			
¼ ∅		654-09-05 654-26-05 5 X 3 mm			
¼ ∅		654-10-06 654-27-06 6 X 4 mm			
			½		
				Ferris-Smith-Kerrison 654-18-01 To 654-34-06 Shaft 18 cm / 7"	
			¼ ∅		654-11-01 654-28-01 1 X 2 mm
			¼ ∅		654-12-01 654-29-01 1 X 2 mm
			¼ ∅		654-13-02 654-30-02 2 X 3 mm
			¼ ∅		654-14-03 654-31-03 3 X 4 mm
			¼ ∅		654-15-04 654-32-04 4 X 4 mm
			¼ ∅		654-16-05 654-33-05 5 X 5 mm
			¼ ∅		654-17-06 654-34-06 6 X 5 mm

**Keilbeinstanzen ; Pinzas cortantes para seno esfenoideal  
Spenoid Punches ; Pinzes per seno sfenoide  
Pincas emporte-pièces pour sinus sphénoïdal ; Pinças de seio esfenoideal**

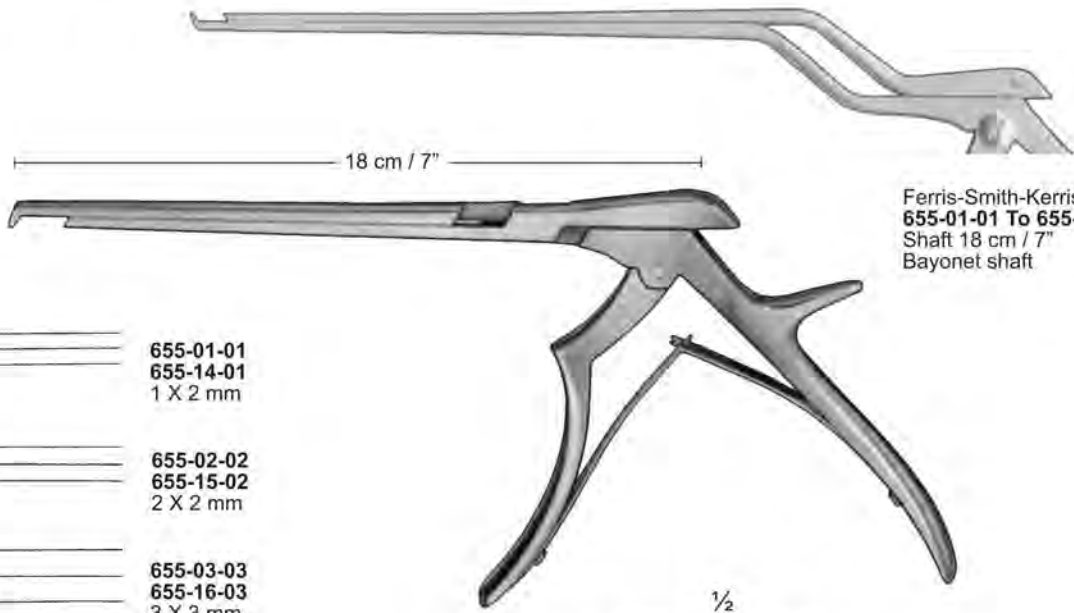

Ferris-Smith-Kerrison  
655-01-01 To 655-13-06  
Shaft 18 cm / 7"  
Bayonet shaft

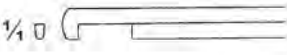
- 

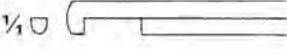
655-01-01  
655-14-01  
1 X 2 mm
- 

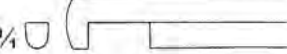
655-02-02  
655-15-02  
2 X 2 mm
- 

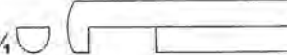
655-03-03  
655-16-03  
3 X 3 mm
- 

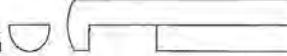
655-04-04  
655-17-04  
4 X 3 mm
- 

655-05-05  
655-18-05  
5 X 3 mm
- 

655-06-06  
655-19-06  
6 X 4 mm

Ferris-Smith-Kerrison  
655-14-01 To 655-26-06  
Shaft 18 cm / 7"

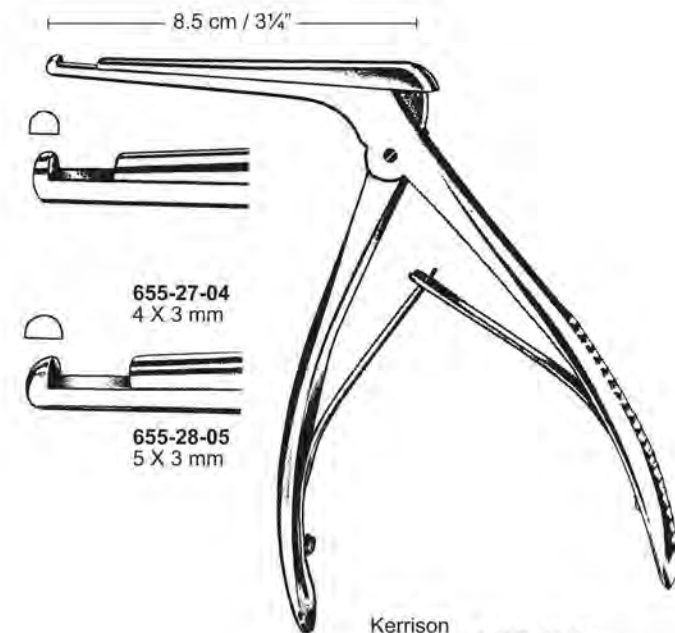

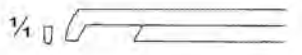

Kerrison  
655-27-04 & 655-28-05  
Shaft 8.5 cm / 3 1/4"

- 

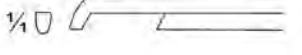
655-07-01  
655-20-01  
1 X 2 mm
- 

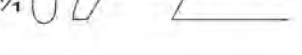
655-08-01  
655-21-01  
1 X 2 mm
- 

655-09-02  
655-22-02  
2 X 3 mm
- 

655-10-03  
655-23-03  
3 X 4 mm
- 

655-11-04  
655-24-04  
4 X 4 mm
- 

655-12-05  
655-25-05  
5 X 5 mm
- 

655-13-06  
655-26-06  
6 X 5 mm



**Keilbeinstanzen ; Pinzas cortantes para seno esfenoideal  
Spenoid Punches ; Pinzes per seno sfenoide  
Pinces emporte-pièces pour sinus sphénoïdal ; Pinças de seio esfenoideal**

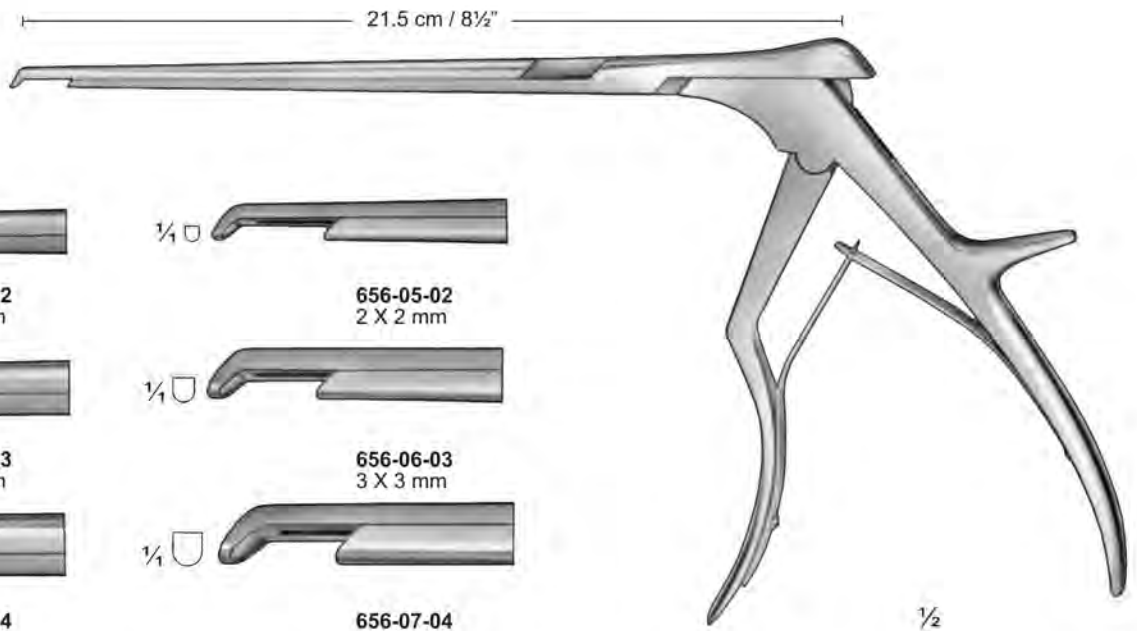

**656-01-02**  
2 X 2 mm



**656-05-02**  
2 X 2 mm



**656-02-03**  
3 X 3 mm



**656-06-03**  
3 X 3 mm



**656-03-04**  
4 X 4 mm



**656-07-04**  
4 X 4 mm



**656-04-05**  
5 X 5 mm



**656-08-05**  
5 X 5 mm

Kerrison  
656-01-02 To 656-08-05  
Shaft 21.5 cm / 8 1/2"

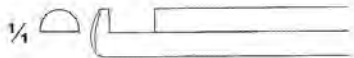
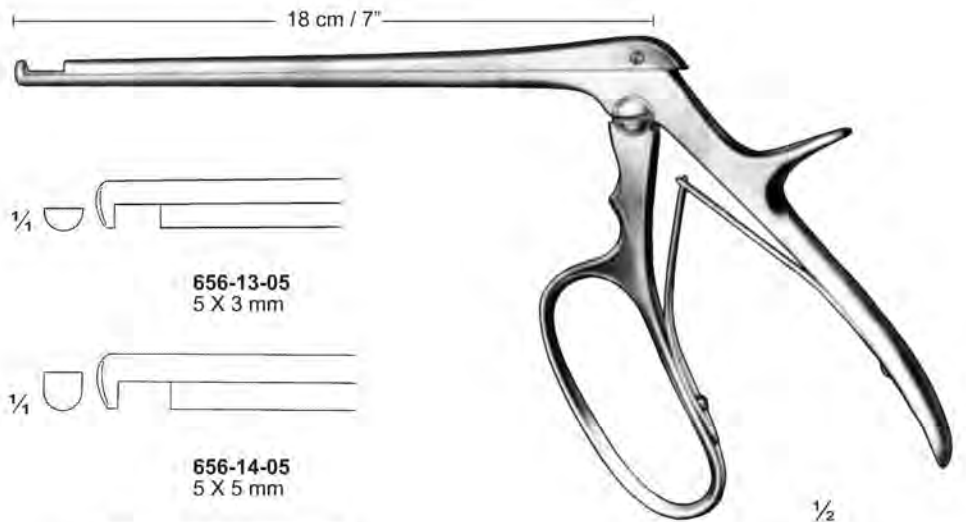

**656-09-05**  
5 X 3 mm

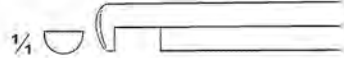

**656-13-05**  
5 X 3 mm

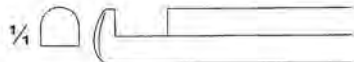

**656-10-05**  
5 X 5 mm

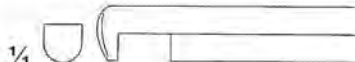

**656-14-05**  
5 X 5 mm

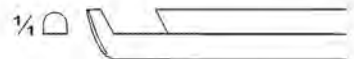

**656-11-03**  
3 X 3 mm

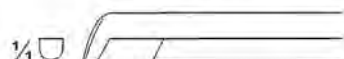

**656-15-03**  
3 X 3 mm

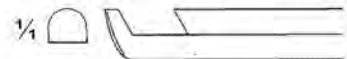

**656-12-05**  
5 X 4 mm

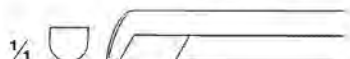

**656-16-05**  
5 X 4 mm

Ferris-Smith-Kerrison  
656-09-05 To 656-16-05  
Shaft 18 cm / 7"

**Keilbeinstanzen  
Punches  
Pinces emporte-pièces pour sinus sphénoïdal**

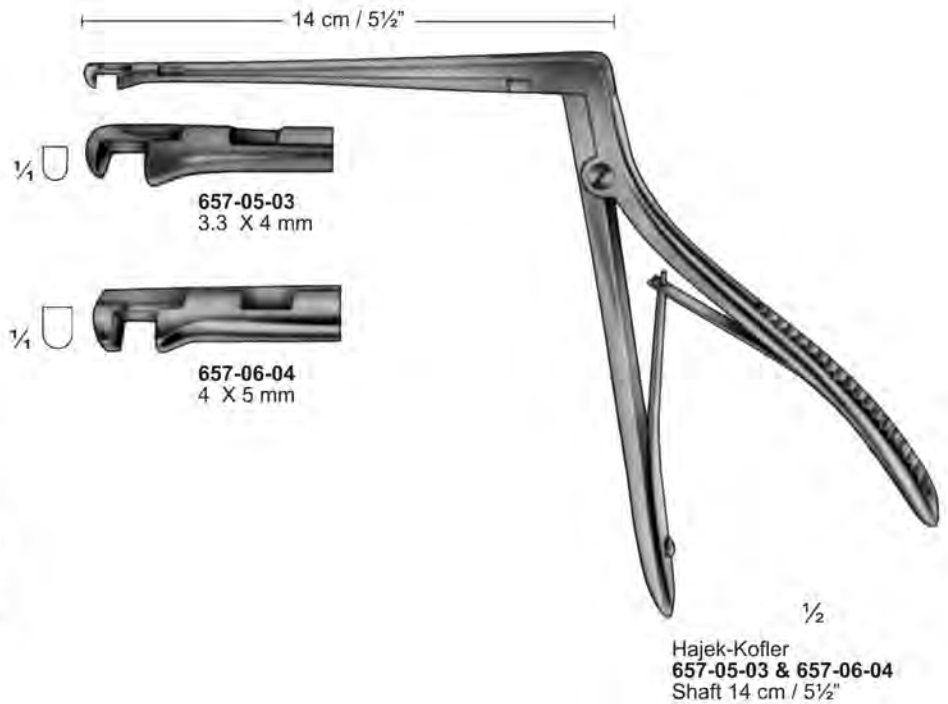
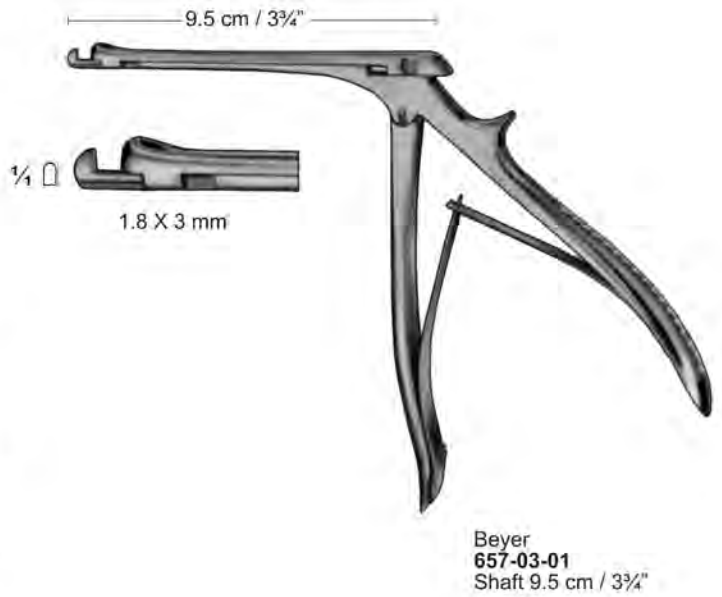
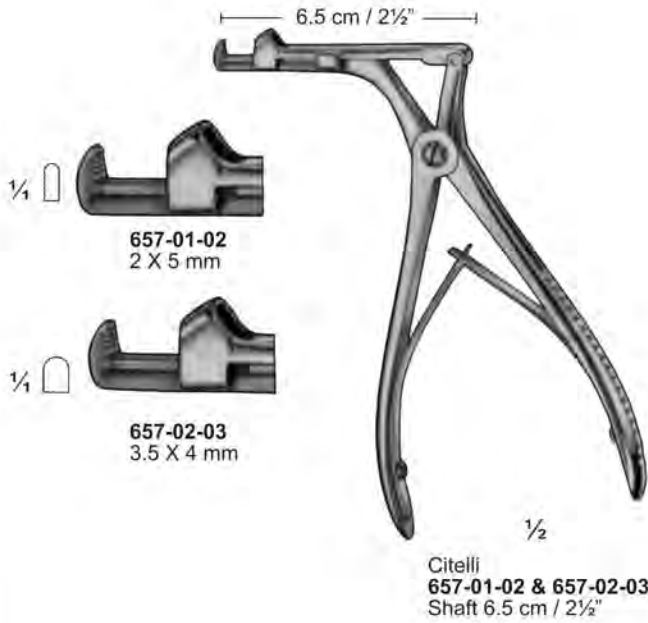

**Keilbeinstanzen  
Punches  
Pincès emporte-pièces pour sinus sphénoïdal**

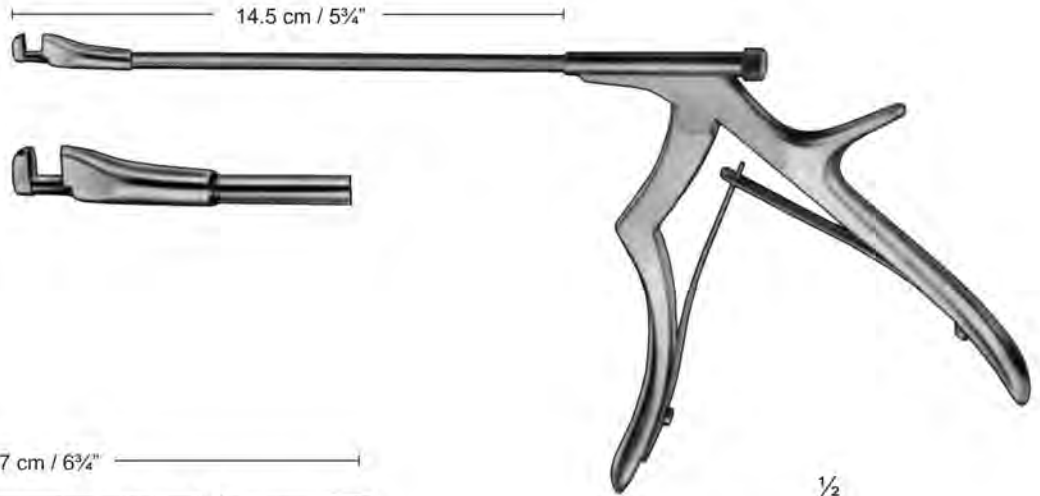

$\frac{1}{2}$   
Kofler  
**658-01-03**  
Shaft 14.5 cm / 5 $\frac{3}{4}$ "

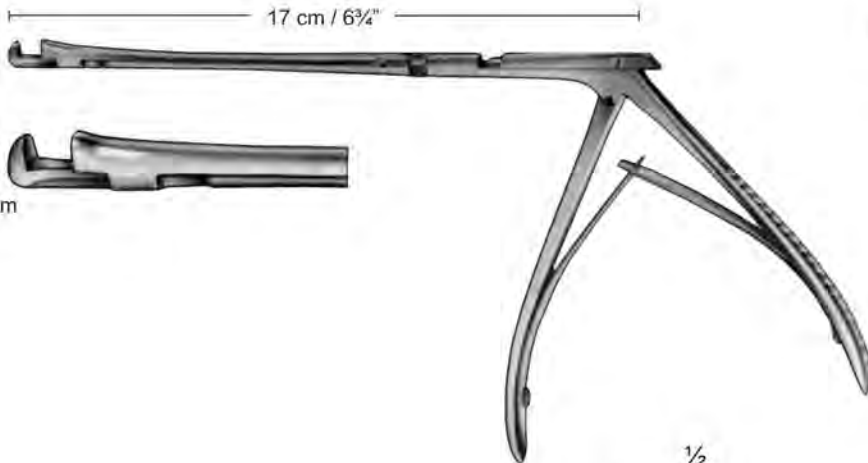

$\frac{1}{4}$   
4 X 4 mm

$\frac{1}{2}$   
Hajek-Kofler  
**658-02-04**  
Shaft 17 cm / 6 $\frac{3}{4}$ "

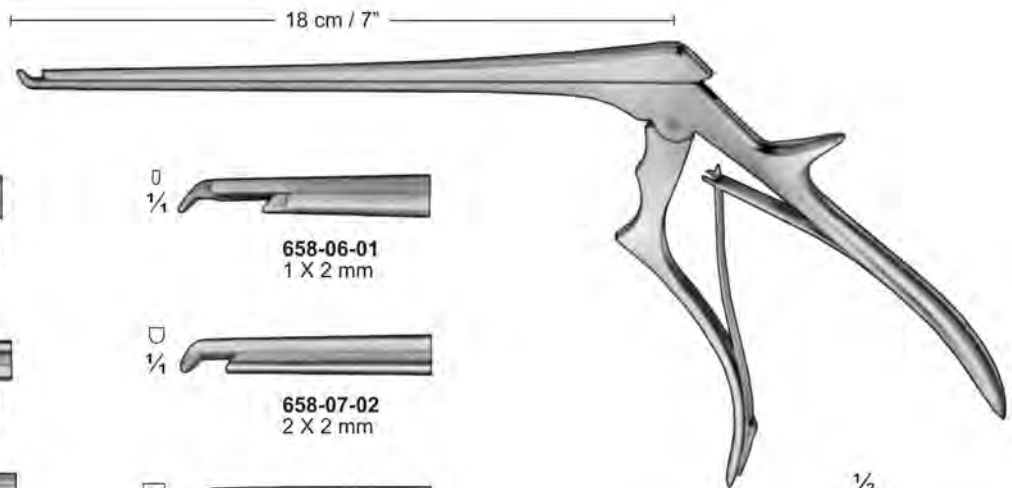

$\frac{0}{1/4}$   
**658-03-01**  
1 X 2 mm

$\frac{0}{1/4}$   
**658-06-01**  
1 X 2 mm

$\frac{0}{1/4}$   
**658-04-02**  
2 X 2 mm

$\frac{0}{1/4}$   
**658-07-02**  
2 X 2 mm

$\frac{0}{1/4}$   
**658-05-03**  
3 X 3 mm

$\frac{0}{1/4}$   
**658-08-03**  
3 X 3 mm

$\frac{1}{2}$   
**658-03-01 To 658-08-03**  
Shaft 18 cm / 7"

**Keilbeinstanzen  
Punches  
Pinces emporte-pièces pour sinus sphénoïdal**

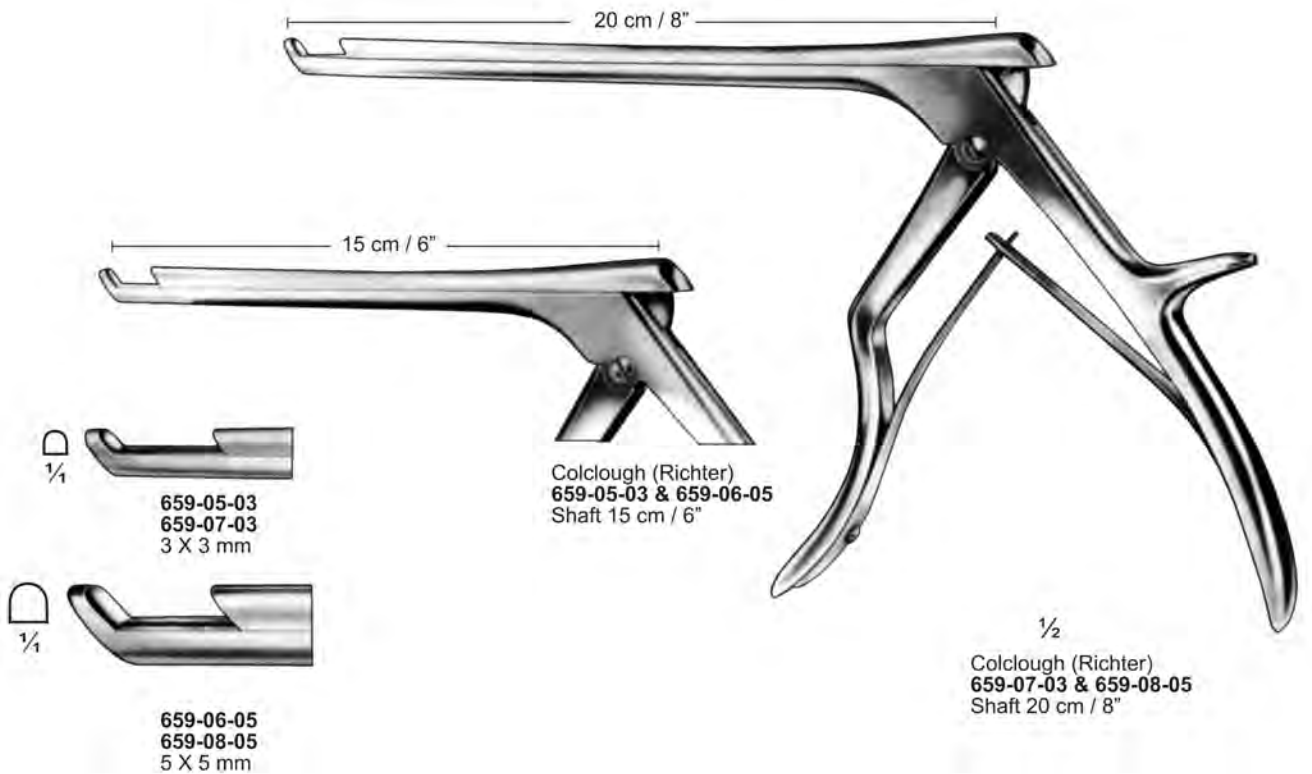
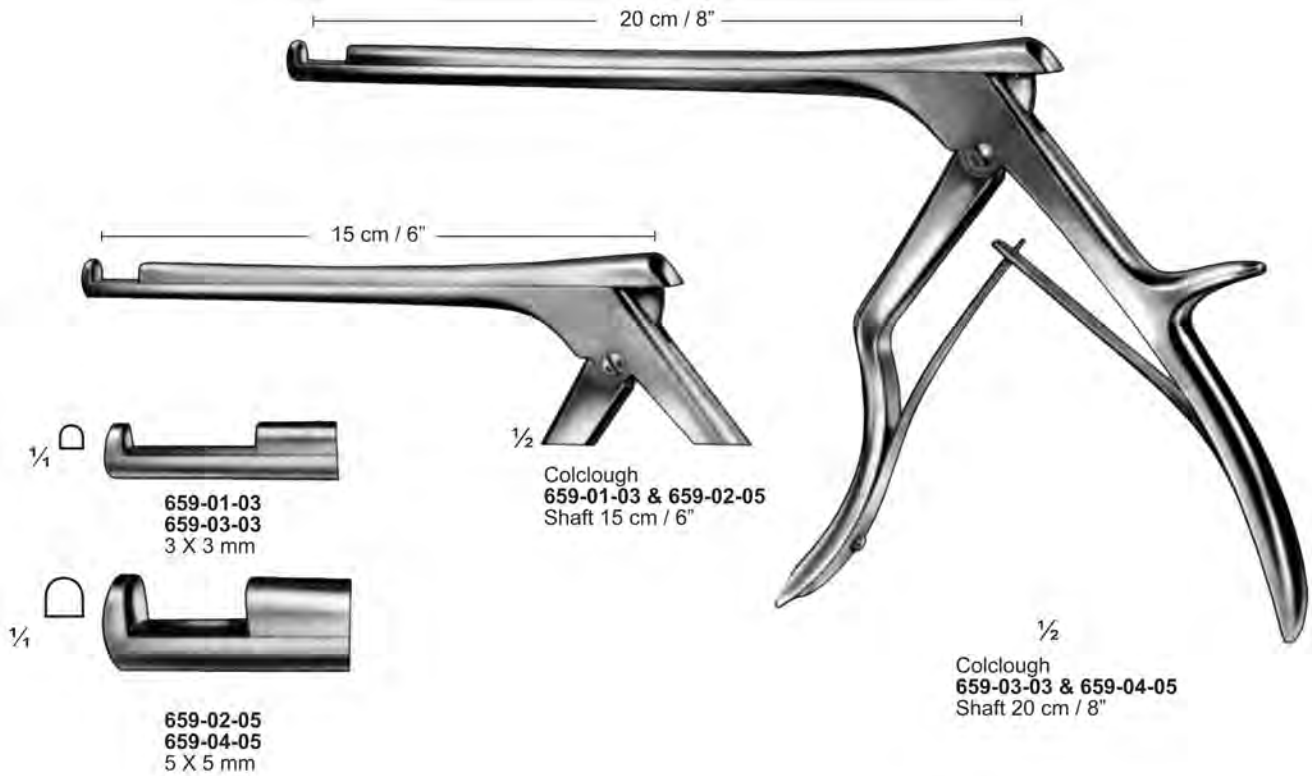

**Keilbeinstanzen  
Punches  
Pinces emporte-pièces pour sinus sphénoïdal**

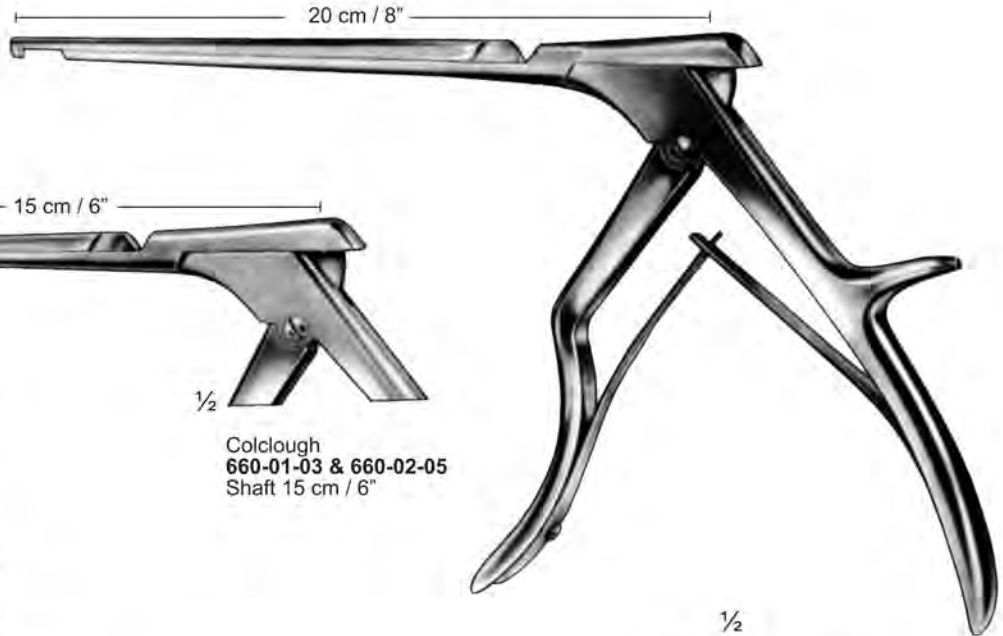

Colclough  
660-01-03 & 660-02-05  
Shaft 15 cm / 6"

1/2  
Colclough  
660-03-03 & 660-04-05  
Shaft 20 cm / 8"



660-01-03  
660-03-03  
3 X 3 mm



660-02-05  
660-04-05  
5 X 5 mm



660-05-04  
4 X 4 mm



660-06-05  
5 X 5 mm



660-07-06  
6 X 6 mm

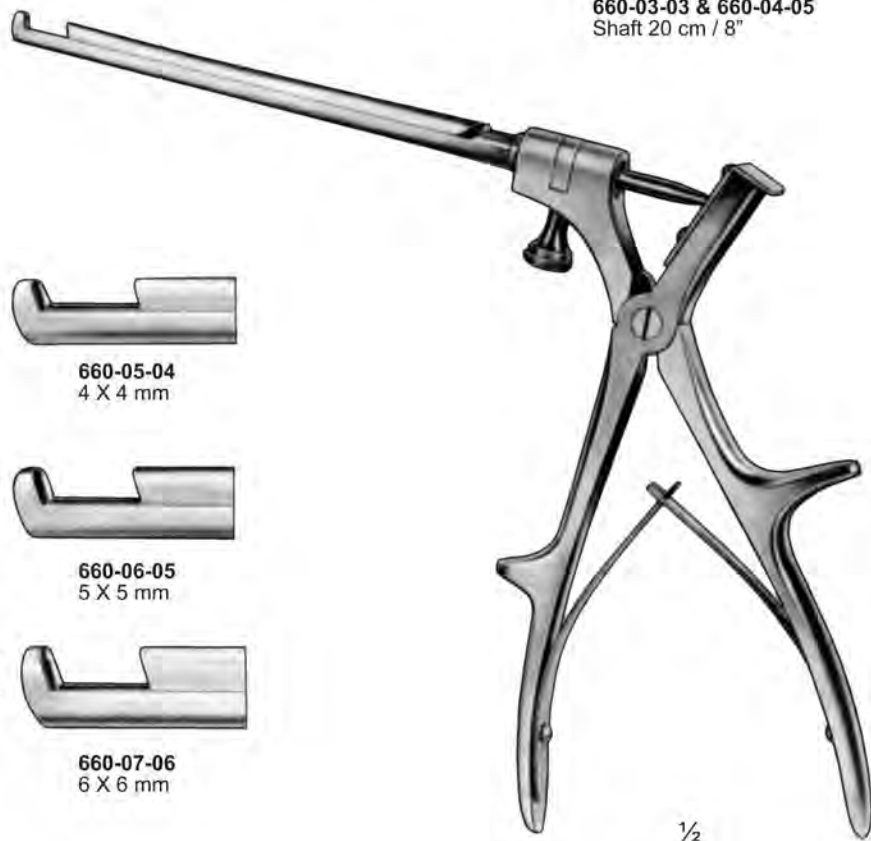

Colclough  
660-05-04 To 660-07-06  
27 cm / 10 1/2"  
With interchangeable tips

**Keilbeinstanzen  
Punches  
Pinces emporte-pièces pour sinus sphénoïdal**

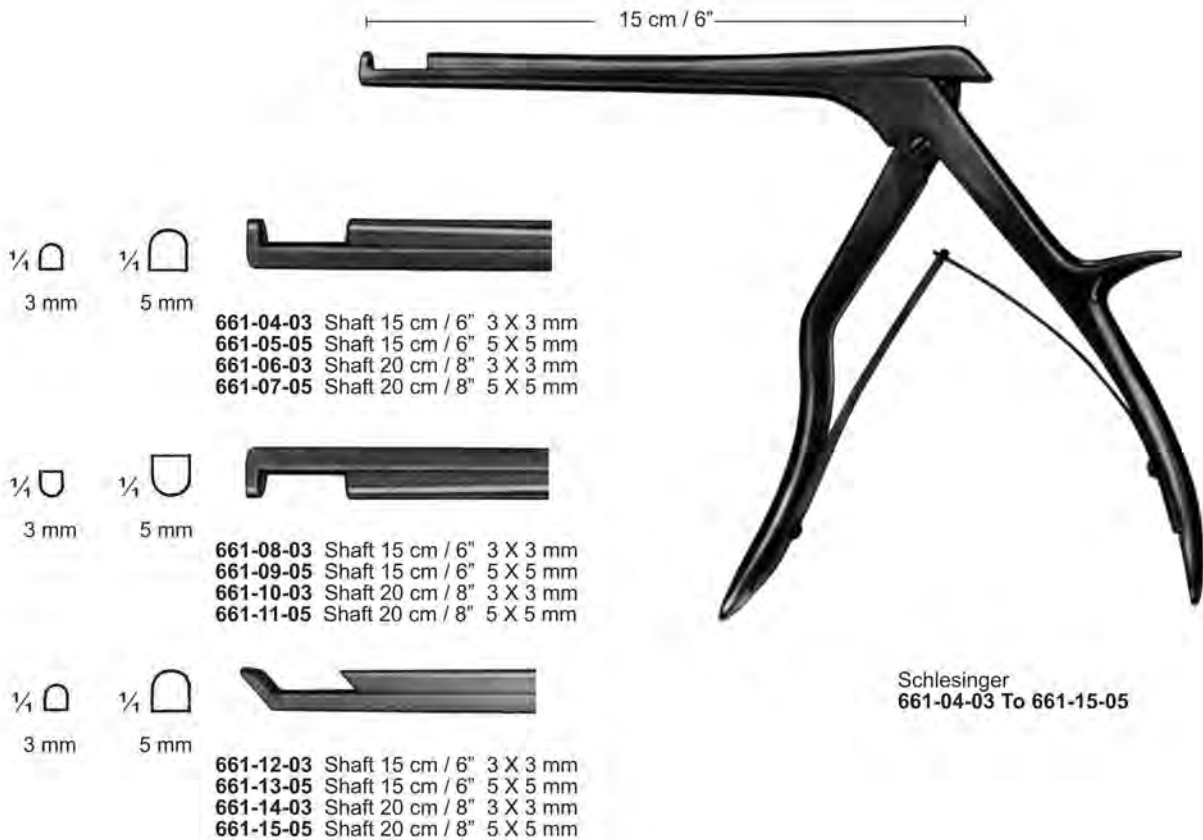
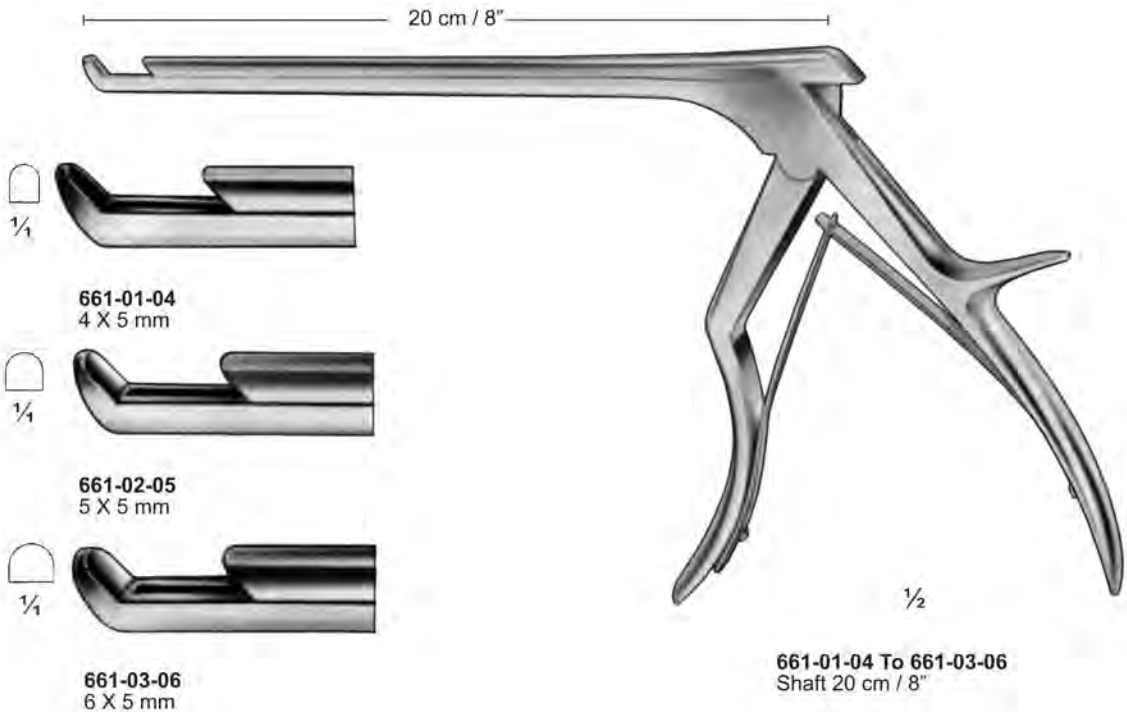



**Keilbeinstanzen, Laminektomiezangen  
Punches, Laminectomy Rongeurs  
Pincers emporte-pièces pour sinus sphénoïdal, Pincers pour laminectomie**

20 cm / 8"

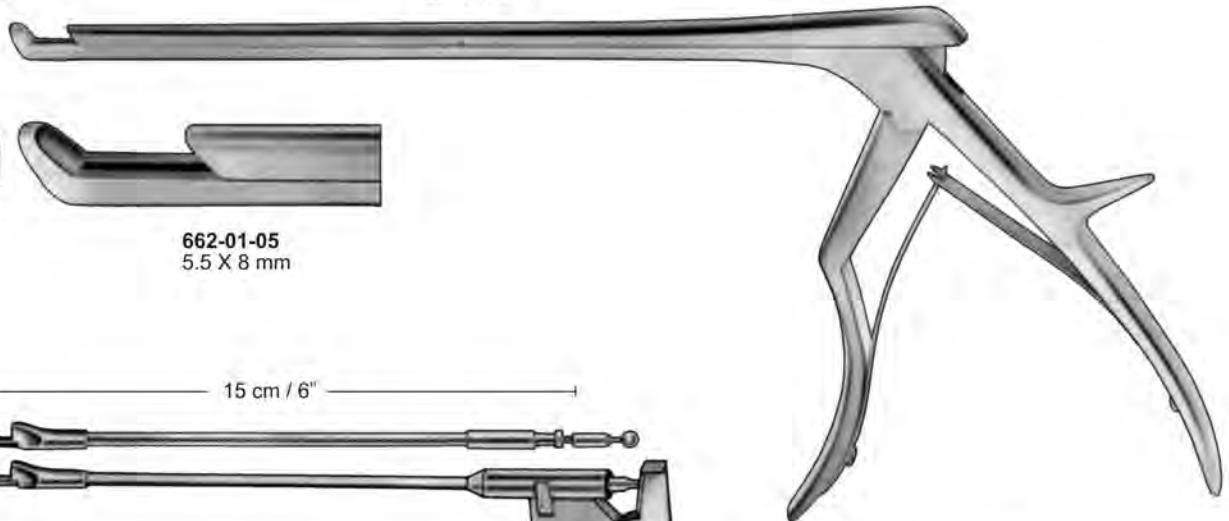

**662-01-05**  
5.5 X 8 mm

Sypert  
**662-01-05**  
Shaft 25 cm / 10"

15 cm / 6"

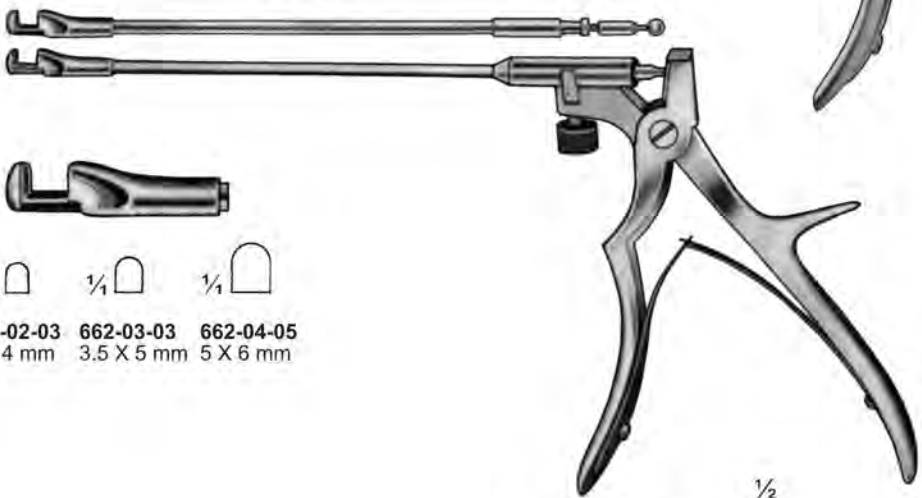

Ferris-Smith  
**662-02-03 To 662-04-05**  
Shaft 15 cm / 6"

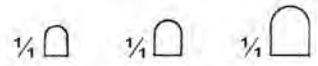

**662-02-03** 3 X 4 mm  
**662-03-03** 3.5 X 5 mm  
**662-04-05** 5 X 6 mm



**662-05-02** 2 X 10 mm  
**662-06-03** 3 X 10 mm  
**662-07-04** 4 X 10 mm

15 cm / 6"

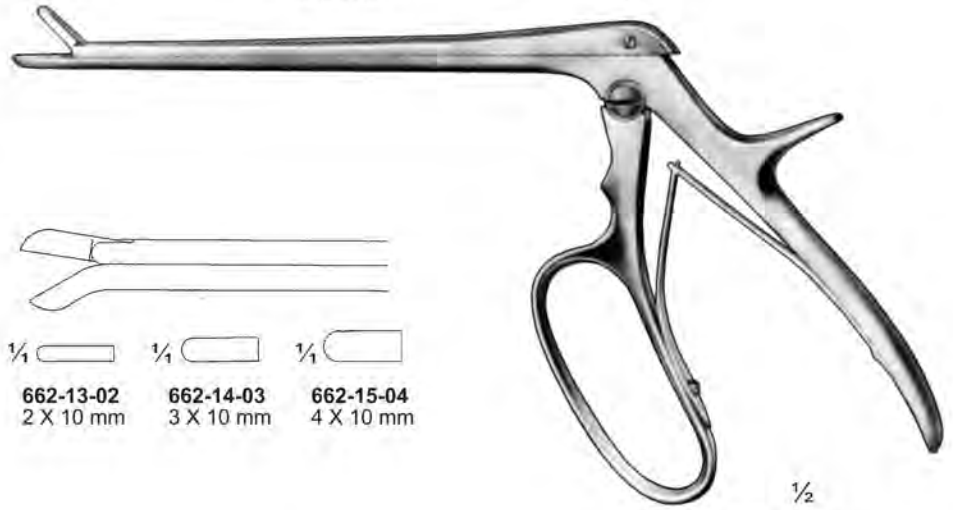

Ferris-Smith-Cushing  
**662-05-02 To 662-15-04**  
Shaft 18 cm / 7"

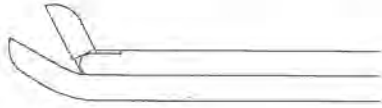

**662-08-02** 2 X 10 mm  
**662-09-03** 3 X 10 mm  
**662-10-04** 4 X 10 mm

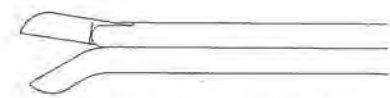

**662-13-02** 2 X 10 mm  
**662-14-03** 3 X 10 mm  
**662-15-04** 4 X 10 mm



**662-11-05** 5 X 10 mm  
**662-12-06** 6 X 10 mm

Laminektomiezanzen  
Laminectomy Rongeurs  
Pincers pour laminectomie

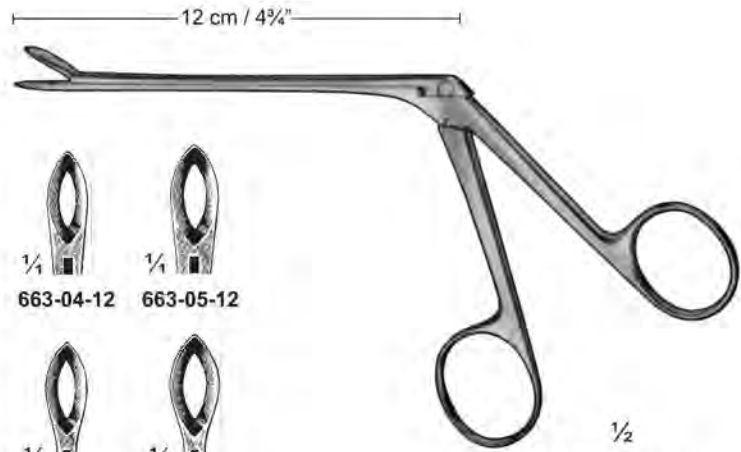
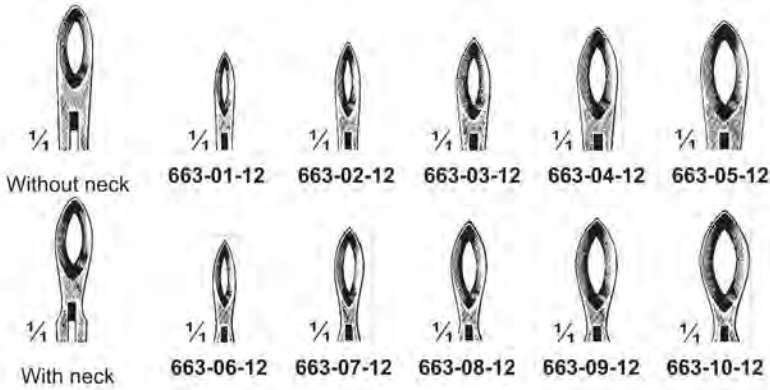

Weil-Blakesley  
663-01-12 To 663-10-12  
Shaft 12 cm / 4 3/4"

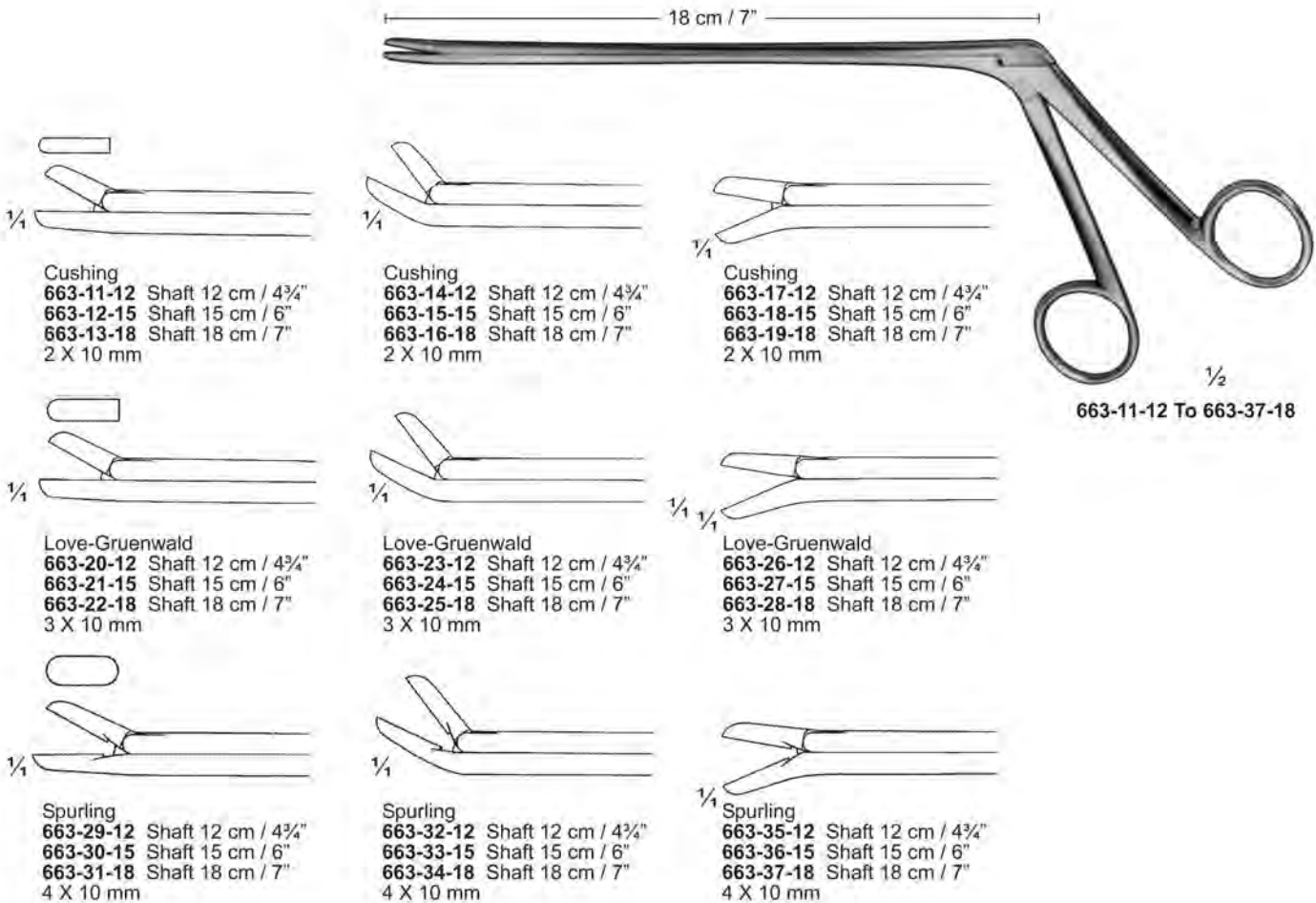



**Laminektomiezanzen  
Laminectomy Rongeurs  
Pincers pour laminectomie**

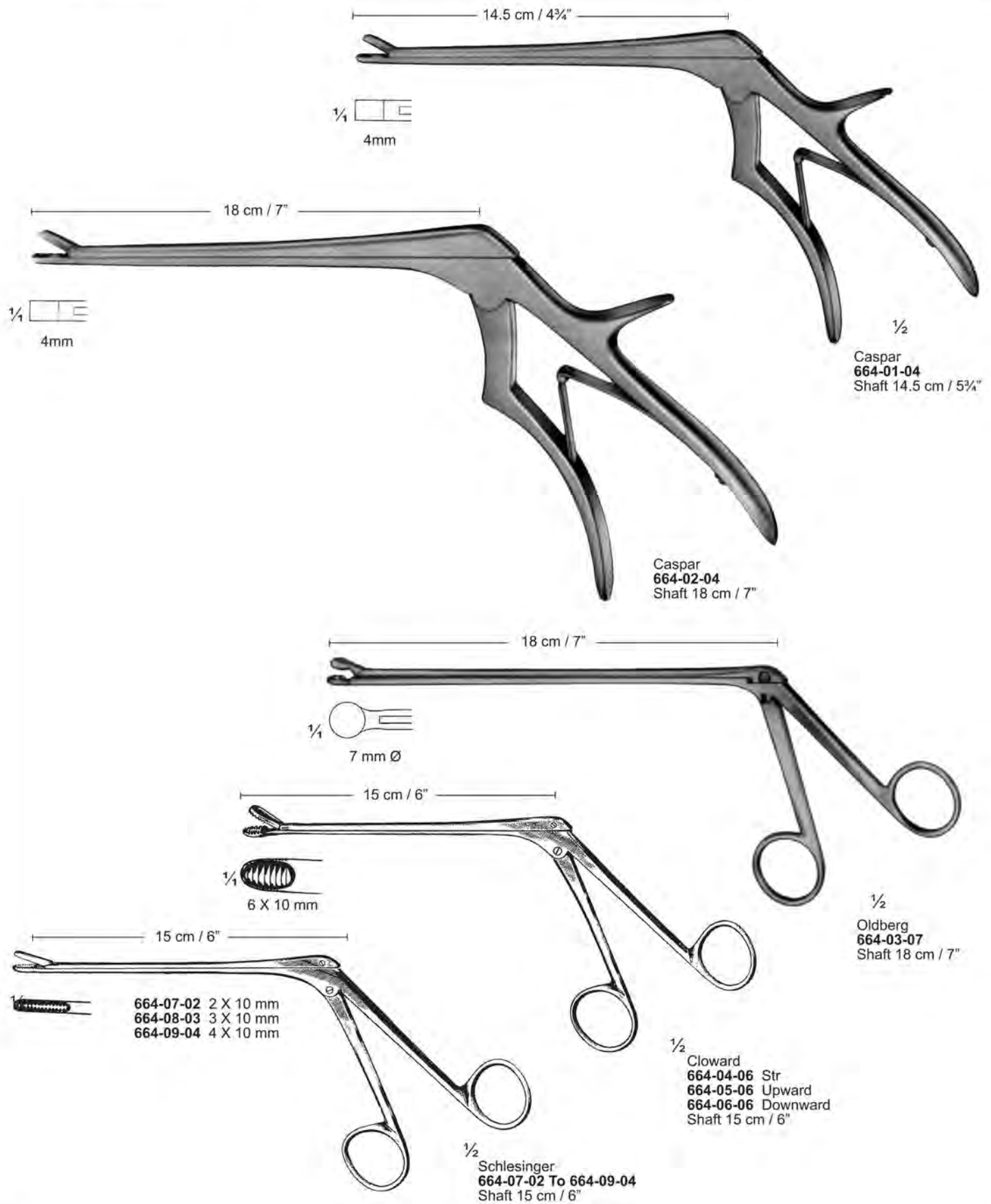

Laminektomieezangen  
Laminectomy Rongeurs  
Pincés pour laminectomie

20 cm / 8"

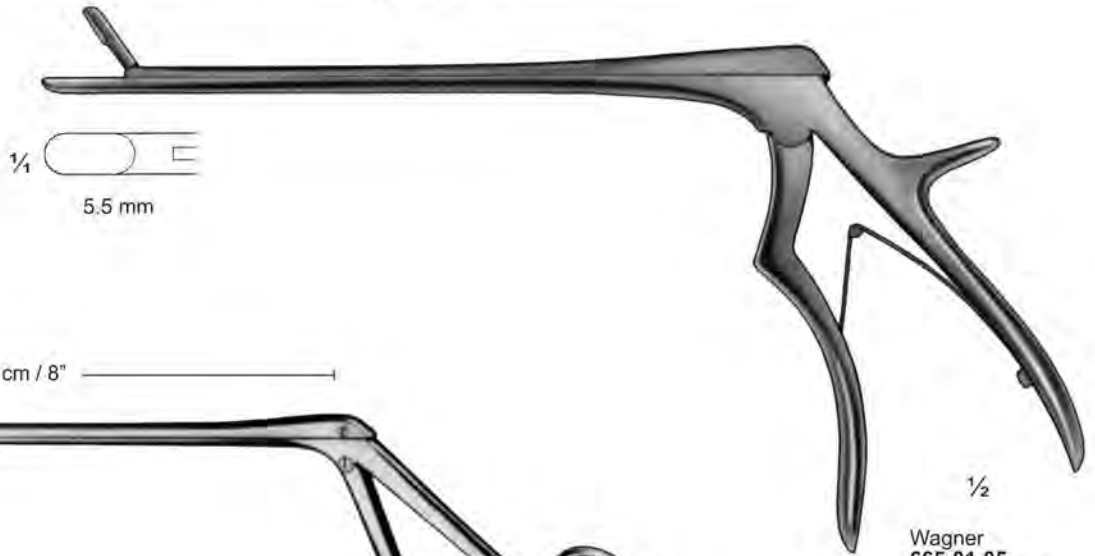

1/4 5.5 mm

Wagner  
665-01-05  
Shaft 20 cm / 8"  
Heavy pattern

20 cm / 8"



1/4 Blunt

Landolt  
665-02-20  
Shaft 20 cm / 8"

21 cm / 8 1/4"

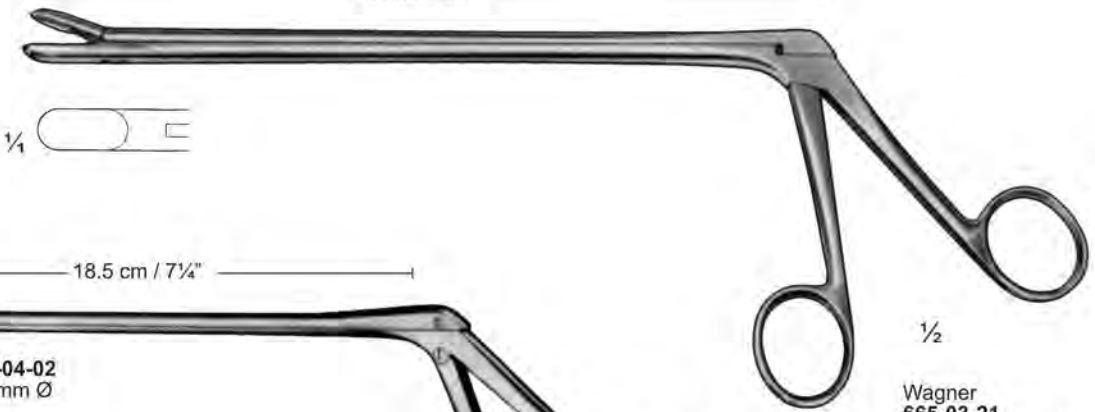

Wagner  
665-03-21  
Shaft 21 cm / 8 1/4"  
Heavy pattern

18.5 cm / 7 1/4"



1/4 665-04-02  
2.2 mm Ø

1/4 665-05-03  
3.5 mm Ø

Yasargil  
665-04-02 & 665-05-03  
Shaft 18.5 cm / 7 1/4"

Laminektomiezanzen  
Laminectomy Rongeurs  
Pincés pour laminectomie

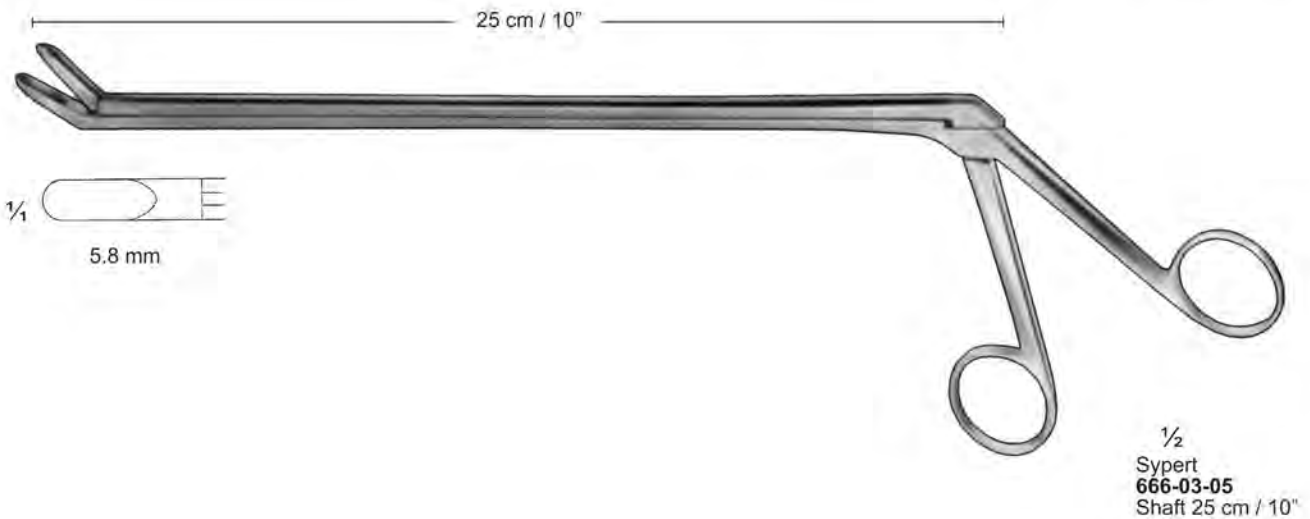
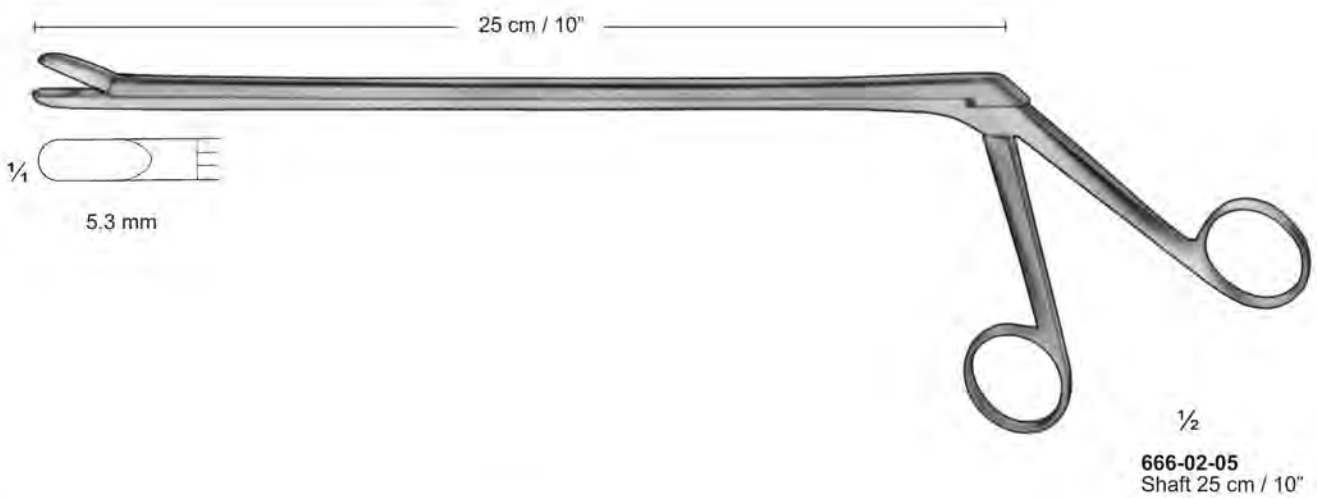
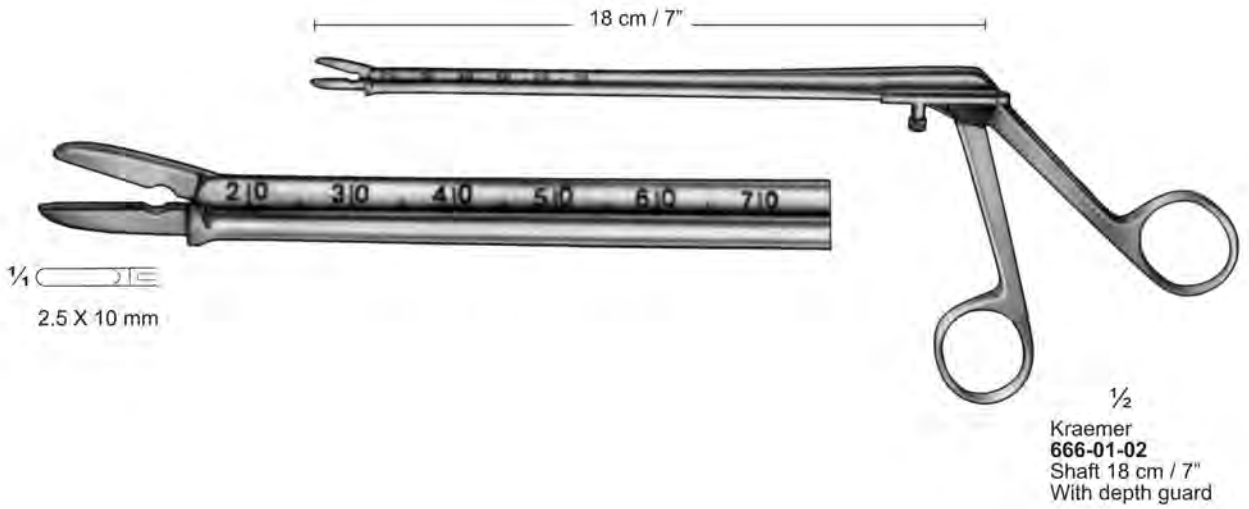

Laminektomiezingen  
Laminectomy Rongeurs  
Pincés pour laminectomie

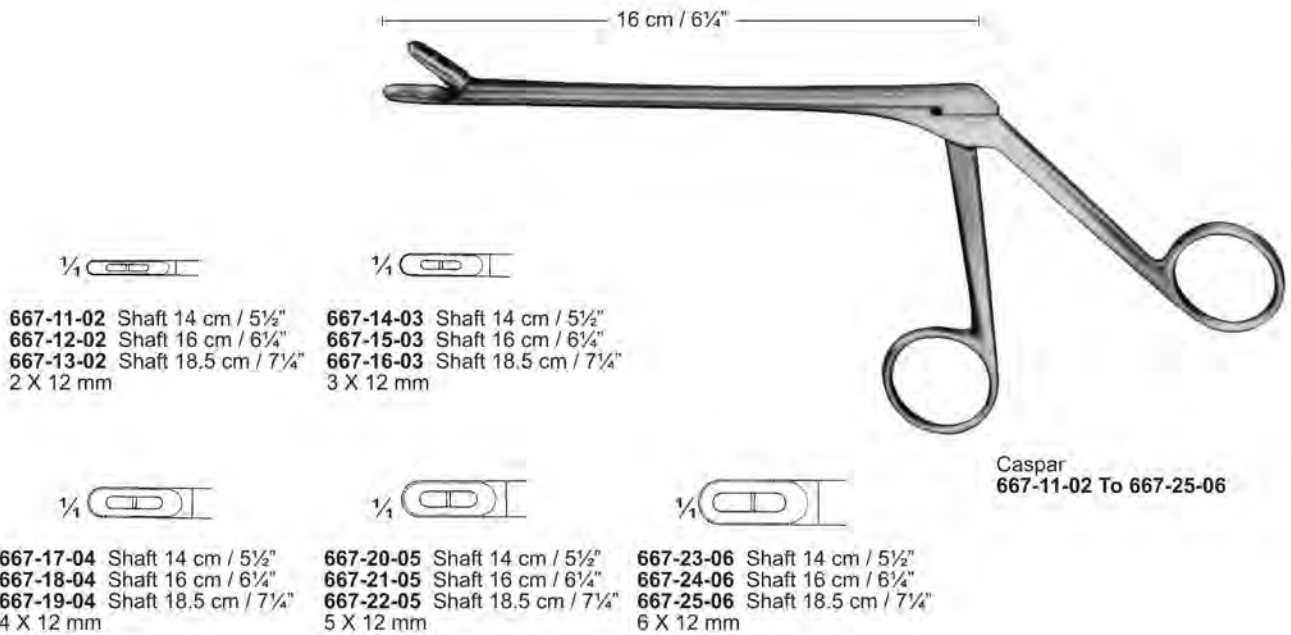
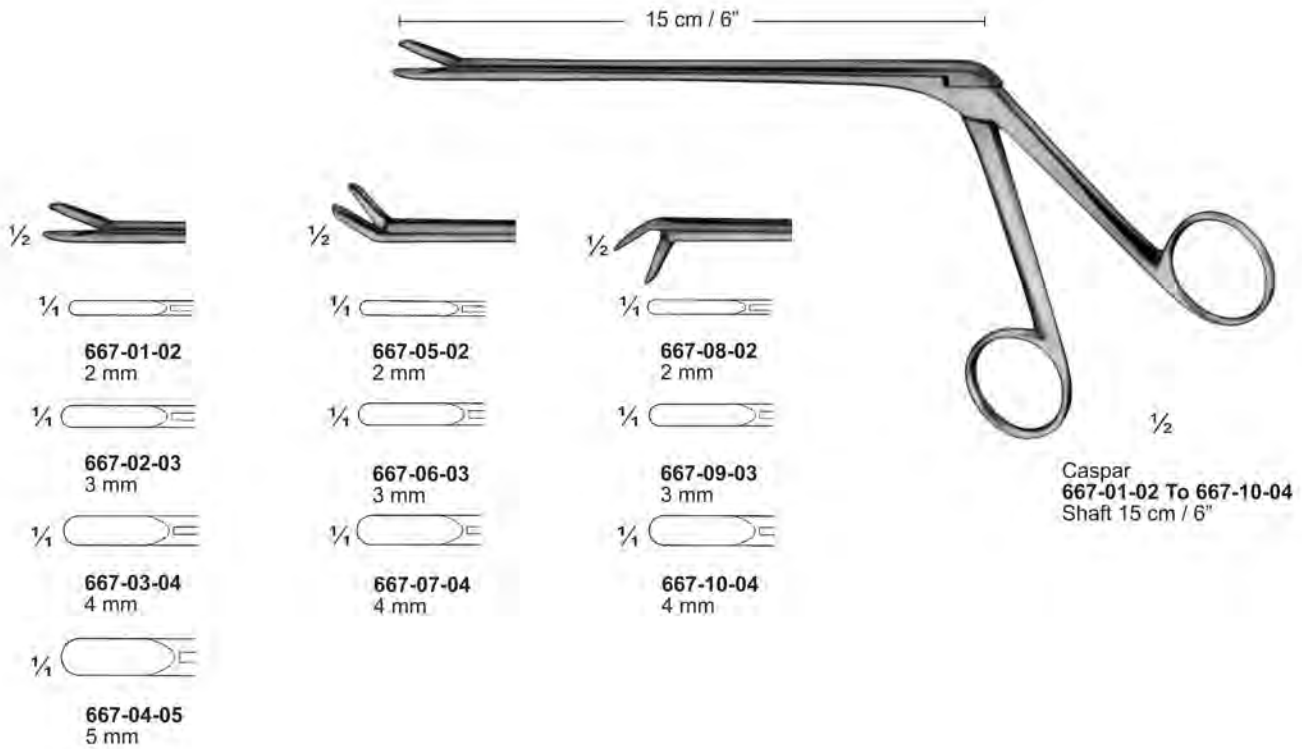

**Laminektomiezanzen  
Laminectomy Rongeurs  
Pincers pour laminectomie**

16 cm / 6 1/4"



1/2  
Caspar  
668-01-03 To 668-09-05



668-01-03 Shaft 14 cm / 5 1/2"  
668-02-03 Shaft 16 cm / 6 1/4"  
668-03-03 Shaft 18.5 cm / 7 1/4"  
3 X 12 mm



668-04-04 Shaft 14 cm / 5 1/2"  
668-05-04 Shaft 16 cm / 6 1/4"  
668-06-04 Shaft 18.5 cm / 7 1/4"  
4 X 12 mm



668-07-05 Shaft 14 cm / 5 1/2"  
668-08-05 Shaft 16 cm / 6 1/4"  
668-09-05 Shaft 18.5 cm / 7 1/4"  
5 X 12 mm

16 cm / 6 1/4"



1/2  
Caspar  
668-10-03 To 668-18-05



668-10-03 Shaft 14 cm / 5 1/2"  
668-11-03 Shaft 16 cm / 6 1/4"  
668-12-03 Shaft 18.5 cm / 7 1/4"  
3 X 12 mm



668-13-04 Shaft 14 cm / 5 1/2"  
668-14-04 Shaft 16 cm / 6 1/4"  
668-15-04 Shaft 18.5 cm / 7 1/4"  
4 X 12 mm



668-16-05 Shaft 14 cm / 5 1/2"  
668-17-05 Shaft 16 cm / 6 1/4"  
668-18-05 Shaft 18.5 cm / 7 1/4"  
5 X 12 mm



668-19-00  
Right



668-20-00  
Left

668-19-00 & 668-20-00

**Ursprüngliche Steinhauser Instrumente  
Original Steinhauser Instruments  
Steinhauser Originaux Instruments**

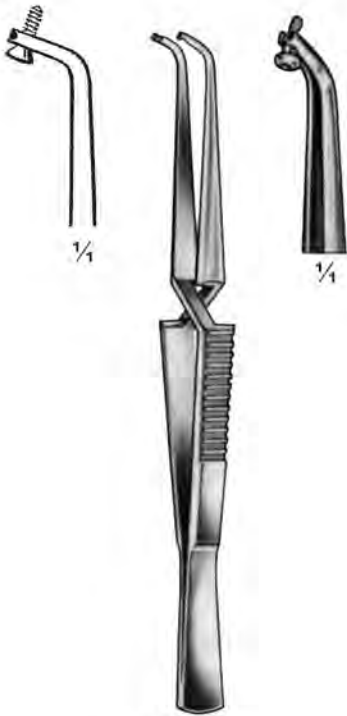

Steinhauser  
**669-01-15**  
15 cm / 6"



Steinhauser  
**669-02-13**  
13.5 cm / 5 1/4"

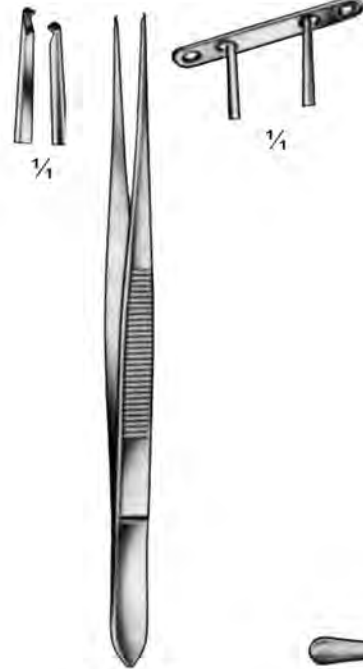

Steinhauser  
**669-03-14**  
14 cm / 5 1/2"



Steinhauser  
**669-04-15**  
15 cm / 6"  
2.7 mm Ø



**669-05-09**  
9 cm / 3 1/2"  
1.5 mm Ø



**669-06-20**  
20 cm / 8"



Steinhauser  
**669-07-23**  
23 cm / 9"  
5 mm Ø



Steinhauser  
**669-08-19**  
19.5 cm / 7 3/4"



Steinhauser  
**669-09-18**  
18 cm / 7"

**Ursprüngliche Steinhauser Instrumente  
Original Steinhauser Instruments  
Steinhauser Originaux Instruments**



**670-01-13**  
13 cm / 5 1/4"  
With tungsten carbide inserts

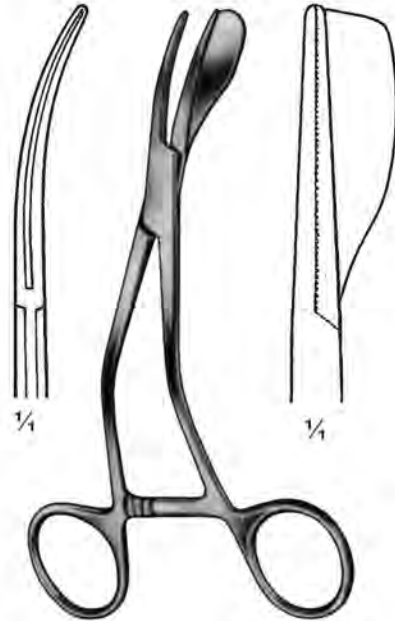

Steinhauser  
**670-02-14**  
14 cm / 5 1/2"  
Right

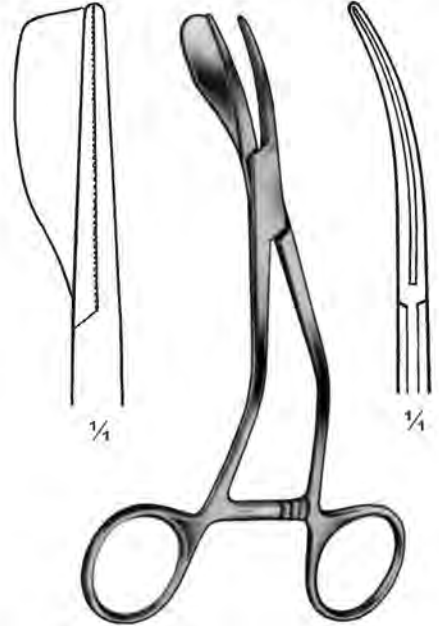

Steinhauser  
**670-03-14**  
14 cm / 5 1/2"  
Left



Steinhauser  
**670-04-13**  
13 cm / 5 1/4"



Steinhauser  
**670-05-23**  
23.5 cm / 9 1/4"  
Left



Steinhauser  
**670-06-23**  
23.5 cm / 9 1/4"  
Right

**Ohrkatheter, Polypenschnürer, Ohrpinzetten**  
**Ear Catheters, Polypus Snares, Ear Forceps**  
**Sondes auriculaires, Serre-noeuds, Pincers auriculaires**



1/2  
Krause  
671-01-17  
17 cm / 6 3/4"



1/2  
Krause-Voss  
671-02-17  
17 cm / 6 3/4"

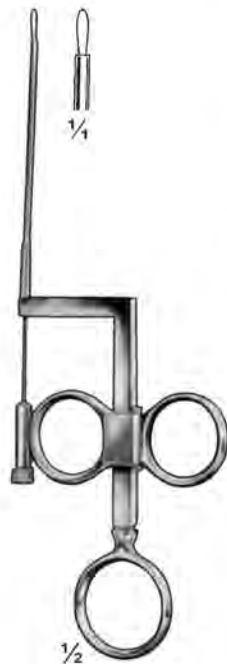

1/2  
Lange-Wilde  
671-03-17  
17 cm / 6 3/4"

1/4  
671-04-13  
Fig. 0

1/4  
671-05-13  
Fig. 1

1/4  
671-06-13  
Fig. 2

1/4  
671-07-13  
Fig. 3

1/4  
671-08-13  
Fig. 4

1/4  
671-09-13  
Fig. 5



1/2  
Hartmann  
671-04-13 To 671-09-13  
13 cm / 5 1/8"

1/4  
671-10-16  
Fig. 1

1/4  
671-11-16  
Fig. 2

1/4  
671-12-16  
Fig. 3

1/4  
671-13-16  
Fig. 4

1/4  
671-14-16  
Fig. 5



1/2  
Troeltsch  
671-10-16 To 671-14-16  
16 cm / 6 1/4"

1/4  
671-15-14  
Fig. 1



1/2  
Itard  
671-15-14 To 671-19-14  
14 cm / 5 1/2"

1/4  
671-20-15  
Fig. 2  
Charr. 7



1/2  
Troeltsch  
671-20-15 To 671-22-15  
15 cm / 6"

1/4  
671-21-15  
Fig. 3  
Charr. 8

1/4  
671-22-15  
Fig. 4  
Charr. 9

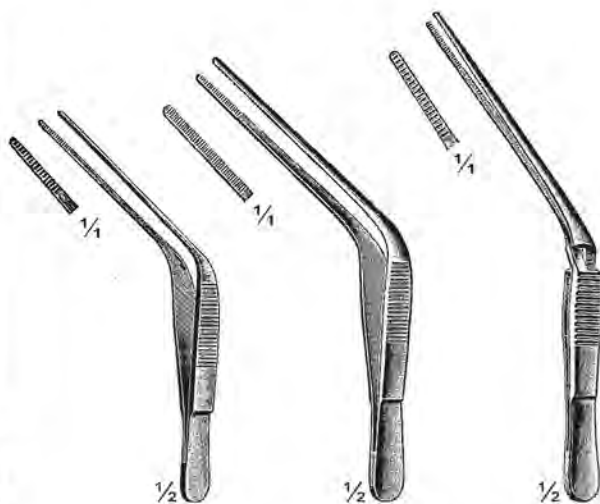

1/4  
Troeltsch (Wilde)  
671-23-11  
11 cm / 4 1/2"

1/4  
Troeltsch (Wilde)  
671-24-12  
12 cm / 4 3/4"

1/4  
Troeltsch (Wilde)  
671-25-13  
13 cm / 5 1/8"



1/2  
Lucae  
671-26-14  
14 cm / 5 1/2"



1/2  
Jansen  
671-27-16 16 cm / 6 1/4"  
671-28-20 20 cm / 8"



**Ohrpolypenzangen  
Ear Polypus Forceps  
Pincettes pour polypes auriculaires**

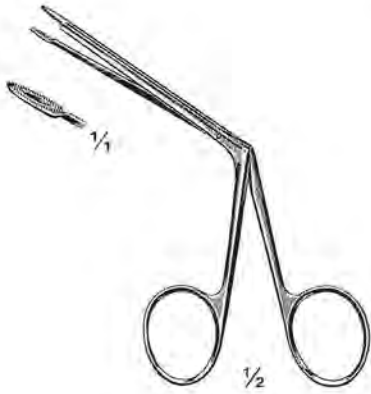

Littauer  
**672-01-12**  
12 cm / 4 3/4"

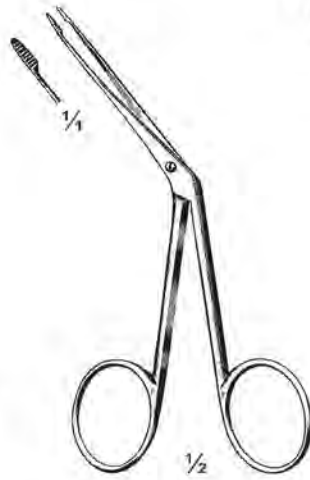

Hartmann  
**672-02-13**  
13 cm / 5 1/4"

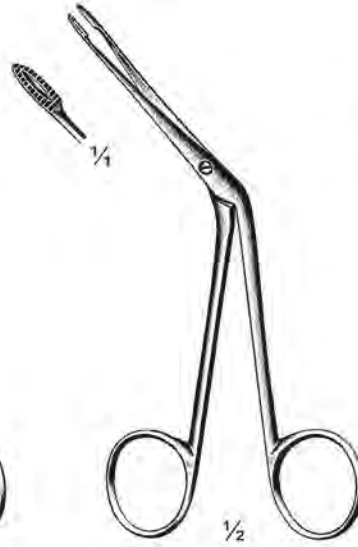

Hartmann  
**672-03-14**  
14 cm / 5 1/2"

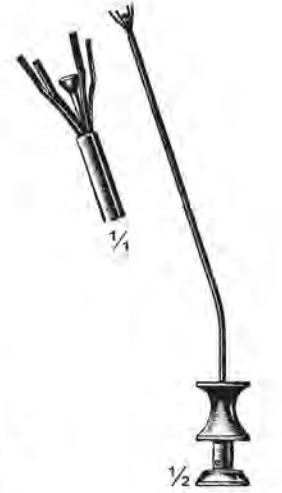

Marquet  
**672-04-14**  
14 cm / 5 1/2"  
1.5 mm Ø

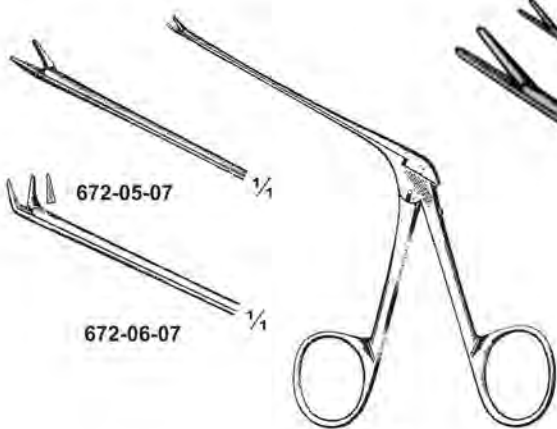

Hartmann  
**672-05-07 & 672-06-07**  
Shaft 7.4 cm / 3"



Bellucci  
**672-07-08**  
Shaft 8 cm / 3 1/4"

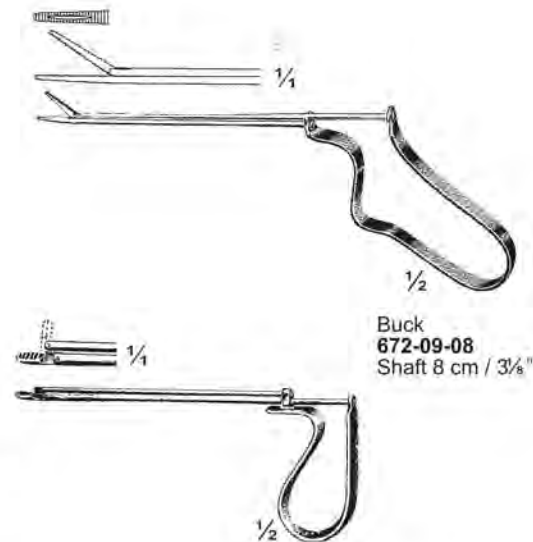

Buck  
**672-09-08**  
Shaft 8 cm / 3 1/8"

Quire  
**672-08-08**  
Shaft 8 cm / 3 1/8"

# Ohrpolypenzangen Ear Polypus Forceps Pincers pour polypes auriculaires

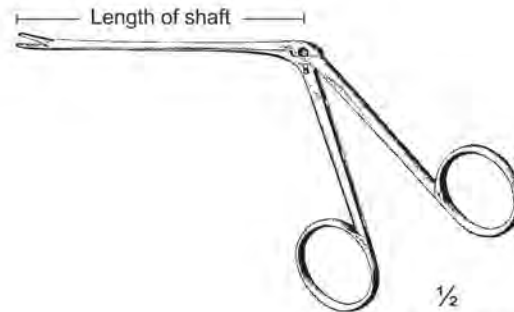

673-01-08 To 673-25-08



Hartmann-Wullstein  
673-01-08  
Shaft 8.5 cm / 3 1/4"



Hartmann  
673-02-08  
Shaft 8.5 cm / 3 1/4"



673-03-08  
Shaft 8 cm / 3 1/8"



Hartmann  
673-04-08 Shaft 8.5 cm / 3 1/4"  
673-05-14 Shaft 14 cm / 5 1/2"  
673-06-16 Shaft 16.5 cm / 6 1/2"



Hartmann-Noyes  
673-07-09  
Shaft 9 cm / 3 1/2"



Hartmann-Noyes  
673-08-08  
Shaft 8.5 cm / 3 1/4"



Hartmann-Weingartner  
673-09-08  
Shaft 8.5 cm / 3 1/4"



Hartmann-Noyes  
673-10-09  
Shaft 9 cm / 3 1/2"  
1 X 2 Teeth



Hartmann  
673-11-08 Shaft 8.5 cm / 3 1/4"  
673-12-14 Shaft 14 cm / 5 1/2"  
1 X 2 Teeth



Hartmann  
673-13-08 2 mm Ø  
673-14-08 2.2 mm Ø  
673-15-08 2.5 mm Ø  
673-16-08 3 mm Ø  
Shaft 8 cm / 3 1/8"

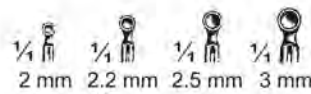

Hartmann  
673-17-08 2 mm Ø  
673-18-08 2.2 mm Ø  
673-19-08 2.5 mm Ø  
673-20-08 3 mm Ø  
Shaft 8 cm / 3 1/8"



Hartmann-Wullstein  
673-21-08  
Shaft 8.5 cm / 3 1/4"  
1 mm Ø



Hartmann  
673-22-08  
Shaft 8.5 cm / 3 1/4"  
2 mm Ø



Struempel  
673-23-08  
Shaft 8.5 cm / 3 1/4"



Hartmann  
673-24-08  
Shaft 8.5 cm / 3 1/4"



Hartmann  
673-25-08  
Shaft 8.5 cm / 3 1/4"

# Mikro-Ohrzängchen Micro Ear Forceps Micro Pincers auriculaires



**674-01-08**  
0.5 X 4 mm  
Str, Smooth



**674-02-08**  
0.5 X 4 mm  
Str, Serr



**674-03-08**  
0.5 X 8 mm  
Str, Serr



**674-04-08**  
0.5 X 3 mm  
Curved up, Serr



**674-05-08**  
0.5 X 3 mm  
Right, Serr



**674-06-08**  
0.5 X 3 mm  
Left, Serr



**674-01-08 To 674-06-08**  
Shaft 8 cm / 3"

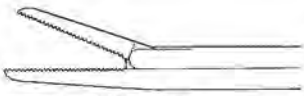

0.6 mm  
4 mm



**674-07-08** 0.6 X 4 mm  
**674-08-08** 0.8 X 4 mm  
Str, Serr



**674-09-08** 0.6 X 3 mm  
**674-10-08** 0.8 X 4 mm  
Curved up, Serr



**674-07-08 To 674-10-08**  
Shaft 8 cm / 3 1/4"

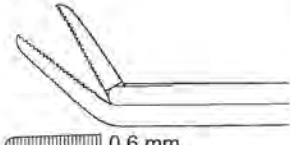

0.6 mm  
3 mm



**674-11-08** 0.6 X 3 mm  
**674-12-08** 0.8 X 4 mm  
Right, Serr

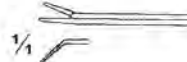

**674-13-08** 0.6 X 3 mm  
**674-14-08** 0.8 X 4 mm  
Left, Serr

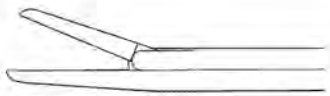

0.6 mm  
4 mm



**674-15-08**  
0.6 X 4 mm  
Str, Smooth



**674-15-08**  
Shaft 8 cm / 3 1/8"



0.6 mm  
3.5 mm



**674-16-08**  
0.6 X 3.5 mm  
Str, Smooth



0.6 mm  
3.5 mm



**674-17-08**  
0.6 X 3.5 mm  
Str, Serr



Mini McGee Alligator  
**674-16-08 & 674-17-08**  
Shaft 8 cm / 3 1/8"

**Mikro-Ohrzangchen**  
**Micro Ear Forceps**  
**Micro Pincers auriculaires**

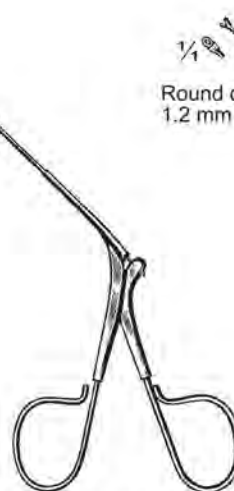
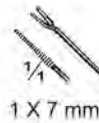
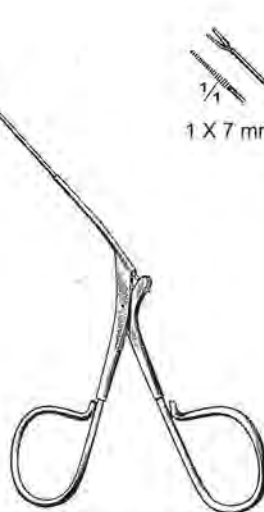
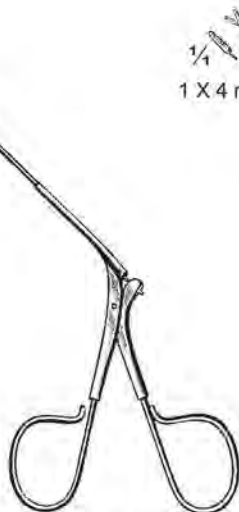
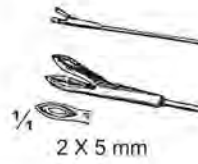
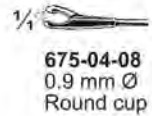
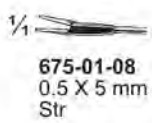



**Mikro-Ohrzangchen, Mikro-Ohrscherchen**  
**Micro Ear Forceps, Micro Ear Scissors**  
**Micro Pincers auriculaires, Micro Ciseaux auriculaires**

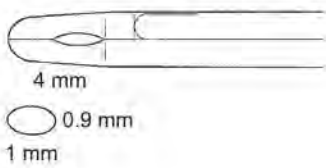

**676-01-08 To 676-04-08**  
 Shaft 8 cm / 3 1/8"  
 Oval cup 0.9 X 1 mm  
 Jaw length 4 mm

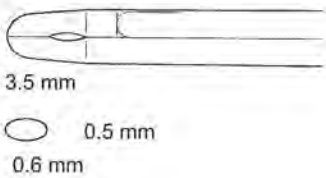
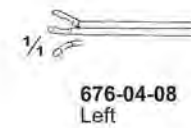
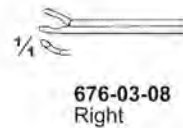

**676-05-08 To 676-08-08**  
 Shaft 8 cm / 3 1/8"  
 Oval cup 0.5 X 0.6 mm  
 Jaw length 3.5 mm

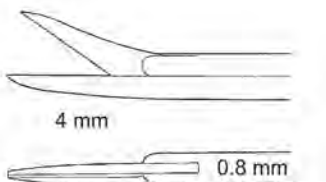
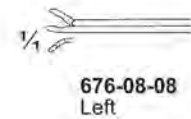

Bellucci  
**676-09-08 To 676-12-08**  
 Shaft 8 cm / 3 1/8"  
 Blade length 4 mm  
 Very delicate

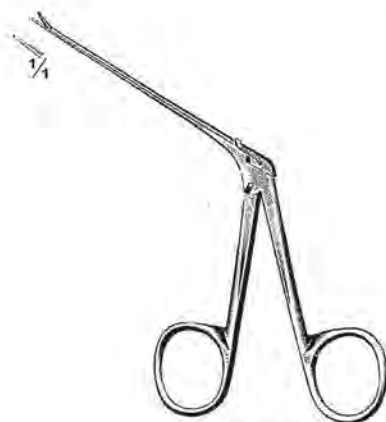
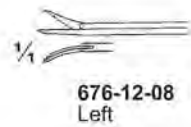

**676-13-08**  
 Shaft 8 cm / 3 1/8"  
 Jaw 0.4 X 4 mm  
 Str

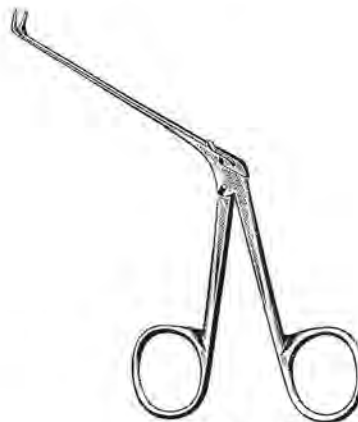

**676-14-08**  
 Shaft 8 cm / 3 1/8"  
 Jaw 0.4 X 4 mm  
 Curved up

**Mikro-Ohrzängchen, Mikro-Ohrscherchen  
Micro Ear Forceps, Micro Ear Scissors  
Micro Pincers auriculaires, Micro Ciseaux auriculaires**

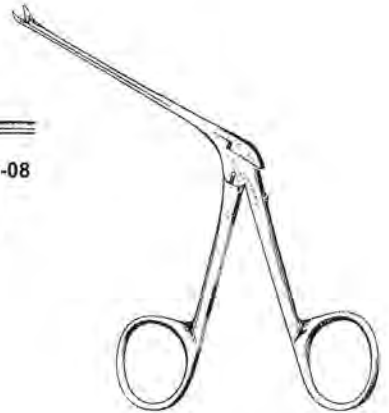
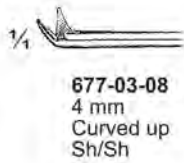

Bellucci  
**677-01-08 To 677-05-08**  
Shaft 8 cm / 3 1/4"

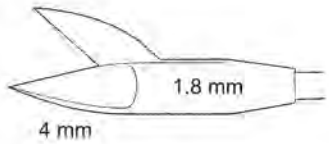

Wullstein  
**677-06-08 To 677-09-08**  
Shaft 8 cm / 3 1/8"  
Shaft 0.8 mm Ø  
Blade length 4 mm

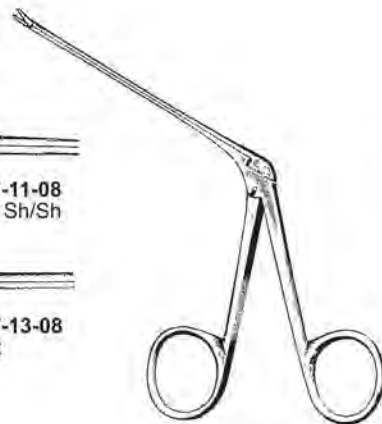
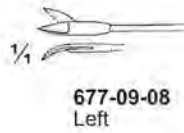
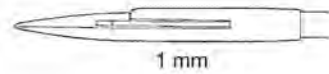

Shea-Bellucci  
**677-10-08 To 677-13-08**  
Shaft 8 cm / 3 1/8"  
Blade length 8 mm

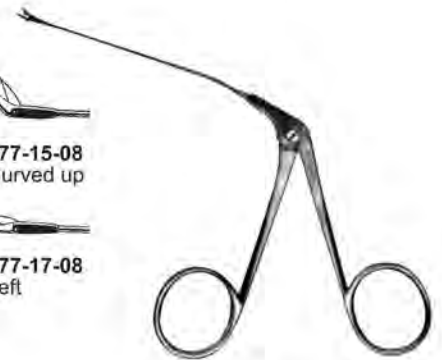

**677-14-08 To 677-17-08**  
Shaft 8 cm / 3 1/8"  
Shaft 0.9 mm Ø  
Blade length 4 mm

**Mikro-Ohrzangchen**  
**Micro Ear Forceps**  
**Micro Pincers auriculaires**



Greven  
**678-01-08**  
Shaft 8 cm / 3 1/4"

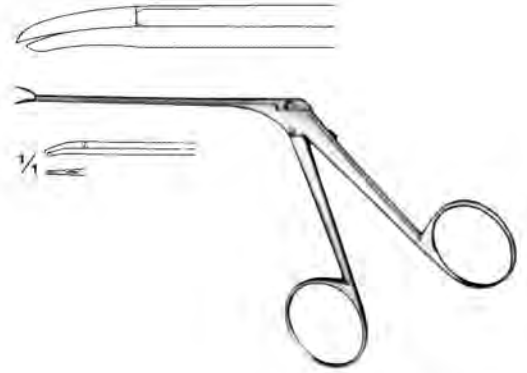

Schuknecht  
**678-02-08**  
Shaft 8 cm / 3 1/4"

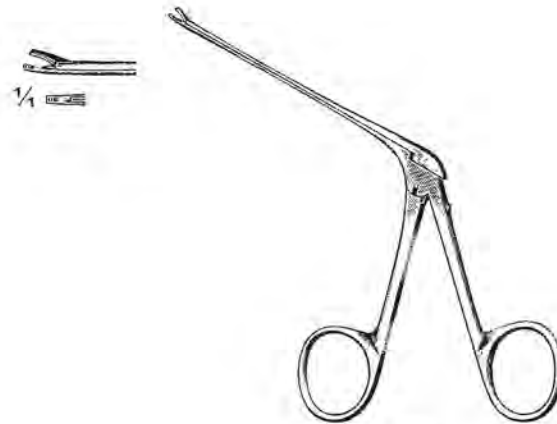

Greven  
**678-03-08**  
Shaft 8 cm / 3 1/4"

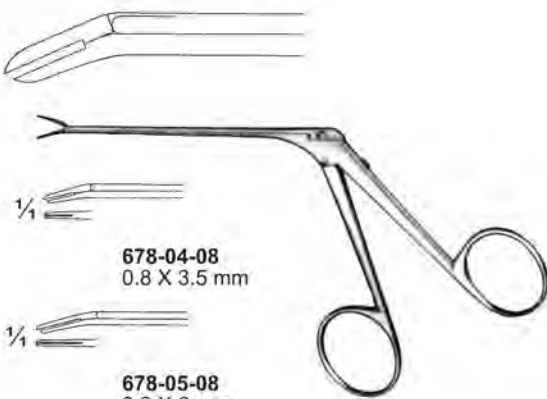

**678-04-08**  
0.8 X 3.5 mm

**678-05-08**  
0.8 X 6 mm

McGee  
**678-04-08 & 678-05-08**  
Shaft 8 cm / 3 1/4"

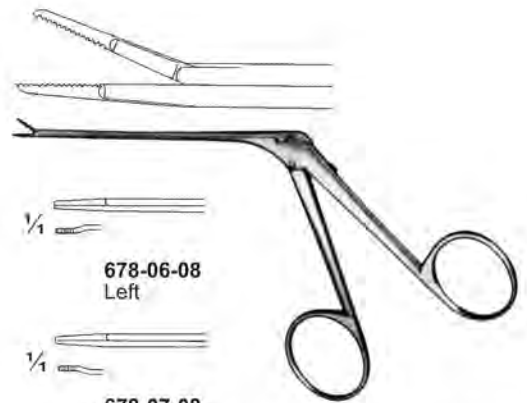

**678-06-08**  
Left

**678-07-08**  
Right

Juers  
**678-06-08 & 678-07-08**  
Shaft 8 cm / 3 1/4"

**Mikro-Ohrzangchen**  
**Micro Ear Forceps**  
**Micro Pincers auriculaires**

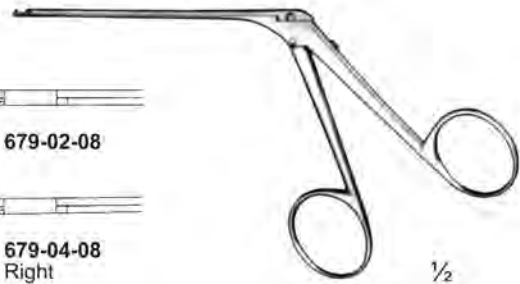
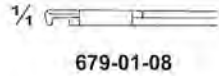
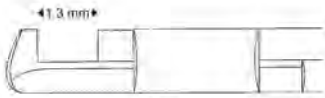

House-Dieter  
**679-01-08 To 679-04-08**  
 Shaft 8 cm / 3 1/8"



Fuller  
**679-05-08**  
 Shaft 8 cm / 3 1/8"  
 Instrument for introducing  
 teflon pistons



Davol  
**679-06-08**  
 Shaft 8 cm / 3 1/8"

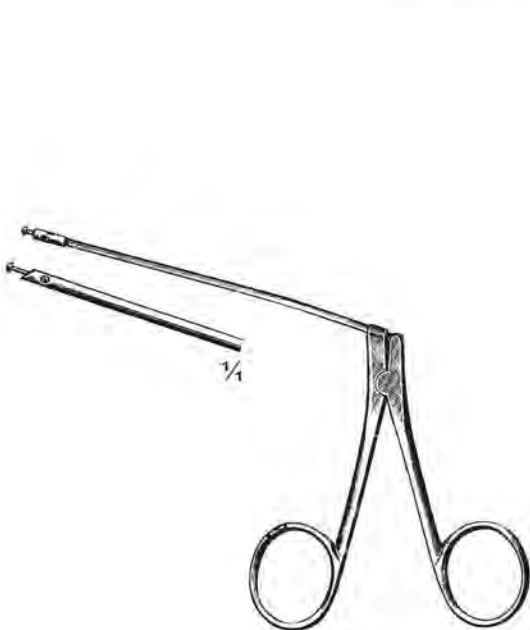

Mehmke  
**679-07-09**  
 Shaft 9 cm / 3 1/2"



Wullstein  
**679-08-08**  
 Shaft 8 cm / 3 1/8"

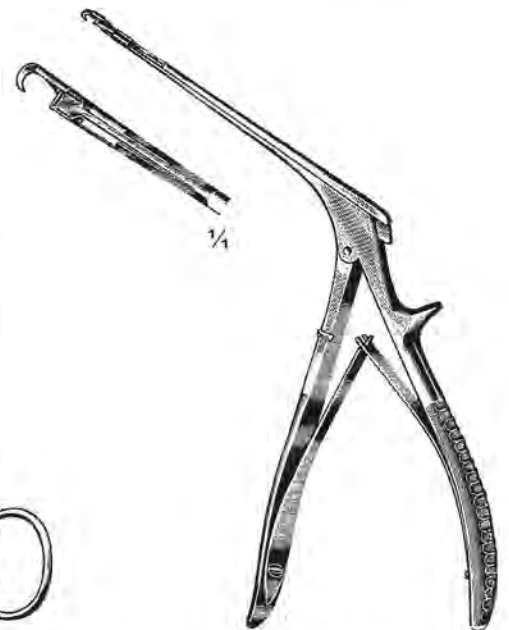

Lempert  
**679-09-09**  
 Shaft 9.5 cm / 3 3/4"





# Ohrspekula Ear Specula Spéculums auriculaires

1/4 ○  
680-01-02  
No. 1  
2.5 mm Ø

1/4 ○  
680-04-03  
No. 0  
3 mm Ø

1/4 ○  
680-09-04  
No. 1  
4.5 mm Ø

1/4 ○  
680-10-05  
No. 2  
5.5 mm Ø

1/4 ○  
680-02-04  
No. 2  
4 mm Ø

1/4 ○  
680-05-04  
No. 1  
4.5 mm Ø

1/4 ○  
680-11-06  
No. 3  
6.5 mm Ø

1/4 ○  
680-12-07  
No. 4  
7.5 mm Ø

1/4 ○  
3 mm Ø

1/4 ○  
4.5 mm Ø

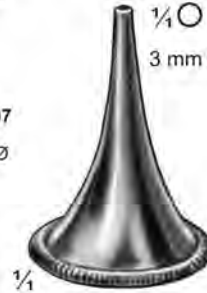

Hartmann  
680-01-02 To 680-06-06  
680-07-03 Set of 3 (680-01-02 To 680-03-05)  
680-08-03 Set of 3 (680-04-03 To 680-06-06)

Hartmann  
680-09-04 To 680-12-07  
680-13-03 Set of 3 (680-10-05 To 680-12-07)  
680-14-04 Set of 4 (680-09-04 To 680-12-07)

Hartmann  
680-15-03

Hartmann  
680-16-04  
For infants

1/4 ○  
680-17-04  
680-23-04  
No. 1  
4.5 mm Ø

1/4 ○  
680-18-05  
680-24-05  
No. 2  
5.5 mm Ø

1/4 ○  
680-19-06  
680-25-06  
No. 3  
6.5 mm Ø

1/4 ○  
680-20-07  
680-26-07  
No. 4  
7.5 mm Ø

1/4 ○  
680-28-03  
No. 1  
3 mm Ø

1/4 ○  
680-29-04  
No. 2  
4.5 mm Ø

1/4 ○  
680-30-05  
No. 3  
5.5 mm Ø

1/4 ○  
680-31-06  
No. 4  
6.5 mm Ø



Toynbee  
680-17-04 To 680-20-07  
680-21-03 Set of 3 (680-18-05 To 680-20-07)  
680-22-04 Set of 4 (680-17-04 To 680-20-07)

Toynbee  
680-23-04 To 680-26-07  
680-27-04  
Set of 4 (680-23-04 To 680-26-07)

Poltzer  
680-28-03 To 680-31-06  
680-32-03 Set of 3 (680-28-03 To 680-30-05)  
680-33-04 Set of 4 (680-28-03 To 680-31-06)

1/4 ○  
680-34-09  
No. 1  
9 mm Ø

1/4 ○  
680-35-11  
No. 2  
11 mm Ø

1/4 ○  
680-37-04  
No. 1  
4.5 mm Ø

1/4 ○  
680-38-05  
No. 2  
5.5 mm Ø

1/4 ○  
680-39-06  
No. 3  
6.5 mm Ø

1/4 ○  
680-40-07  
No. 4  
7.5 mm Ø

1/4 ○  
680-42-02  
2 mm Ø

1/4 ○  
680-43-03  
3 mm Ø

1/4 ○  
680-44-04  
4 mm Ø

1/4 ○  
680-45-05  
5 mm Ø

1/4 ○  
680-46-06  
6 mm Ø

1/4 ○  
680-47-07  
7.5 mm Ø



Hartmann  
680-34-09 & 680-35-11  
680-36-02  
Set of 2 (680-34-09 & 680-35-11)

Boucheron  
680-37-04 To 680-40-07  
680-41-04  
Set of 4 (680-37-04 To 680-40-07)

680-42-02 To 680-47-07  
680-48-06  
Set of 6 (680-42-02 To 680-47-07)

$\frac{1}{4}$  O  
**681-01-03**  
No. 1  
3 mm Ø



$\frac{1}{4}$  O  
**681-02-04**  
No. 2  
4 mm Ø

$\frac{1}{4}$  O  
**681-03-05**  
No. 3  
5 mm Ø

Troeltsch  
**681-01-03 To 681-03-05**  
**681-04-03**  
Set of 3 (681-01-03 To 681-03-05)

$\frac{1}{4}$  O  
**681-05-06**  
No. 1  
6 mm Ø



$\frac{1}{4}$  O  
**681-06-07**  
No. 2  
7 mm Ø

$\frac{1}{4}$  O  
**681-07-08**  
No. 3  
8 mm Ø

Troeltsch  
**681-05-06 To 681-07-08**  
**681-08-03**  
Set of 3 (681-05-06 To 681-07-08)

$\frac{1}{4}$  O  
**681-09-04**  
No. 1  
4.5 mm Ø



$\frac{1}{4}$  O  
**681-10-05**  
No. 2  
5.5 mm Ø

$\frac{1}{4}$  O  
**681-11-06**  
No. 3  
6.5 mm Ø

$\frac{1}{4}$  O  
**681-12-07**  
No. 4  
7.5 mm Ø

Gruber  
**681-09-04 To 681-12-07**  
**681-13-03** Set of 3 (681-09-04 To 681-11-06)  
**681-14-04** Set of 4 (681-09-04 To 681-12-07)

$\frac{1}{4}$  O  
**681-15-05**  
No. 1  
5.5 X 6.5 mm



$\frac{1}{4}$  O  
**681-16-06**  
No. 2  
6.5 X 7.5 mm

$\frac{1}{4}$  O  
**681-17-07**  
No. 3  
7.5 X 8.5 mm

$\frac{1}{4}$  O  
**681-18-08**  
No. 4  
8.5 X 9.5 mm

$\frac{1}{4}$  O  
**681-19-09**  
No. 5  
9.5 X 10.5 mm

$\frac{1}{4}$  O  
**681-20-10**  
No. 6  
10.5 X 11.5 mm

Zoellner  
**681-15-05 To 681-20-10**  
**681-21-06**  
Set of 6 (681-15-05 To 681-20-10)

$\frac{1}{4}$  O  
**681-22-03**  
No. 1  
3.5 X 4.5 mm



$\frac{1}{4}$  O  
**681-23-04**  
No. 2  
4.5 X 5.5 mm

$\frac{1}{4}$  O  
**681-24-05**  
No. 3  
5.5 X 6.5 mm

$\frac{1}{4}$  O  
**681-25-06**  
No. 4  
6.5 X 7.5 mm

Gruber  
**681-22-03 To 681-25-06**  
**681-26-03** Set of 3 (681-22-03 To 681-24-05)  
**681-27-04** Set of 4 (681-22-03 To 681-25-06)



**681-28-10**  
10 cm / 4"



**681-29-06**  
6 cm / 2 1/2"  
Speculum holder

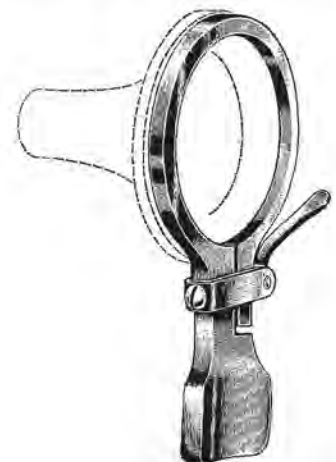

**681-30-06**  
6 cm / 2 1/2"  
Speculum holder

**Ohrspekula  
Ear Specula  
Spéculums auriculaires**



Holmagren  
682-01-06 & 682-02-07

$\frac{1}{4}$    
682-01-06  
No. 1  
6 mm Ø

$\frac{1}{4}$    
682-02-07  
No. 2  
7 mm Ø



Richnau-Holmgren  
682-03-03 To 682-06-06

$\frac{1}{4}$    
682-03-03  
No. 0  
3 mm Ø

$\frac{1}{4}$    
682-04-04  
No. 1  
4 mm Ø

$\frac{1}{4}$    
682-05-05  
No. 3  
5 mm Ø

$\frac{1}{4}$    
682-06-06  
No. 4  
6 mm Ø

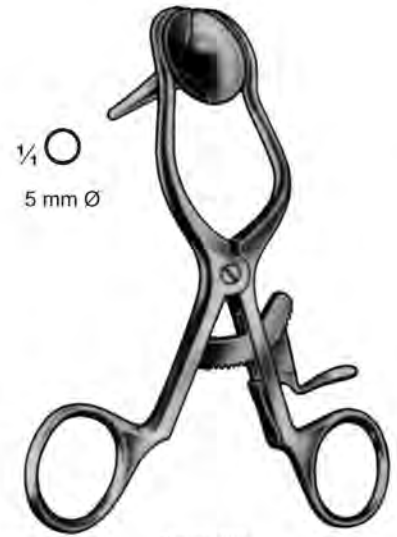

Paparella  
682-07-06  
13 cm / 5 $\frac{1}{4}$ "

$\frac{1}{4}$    
5 mm Ø



Erhardt  
682-08-04 To 682-10-06  
682-11-03 Set of 3 (682-08-04 To 682-10-06)

$\frac{1}{4}$    
682-08-04  
No. 1  
4.5 mm Ø

$\frac{1}{4}$    
682-09-05  
No. 2  
5.5 mm Ø

$\frac{1}{4}$    
682-10-06  
No. 3  
6.5 mm Ø



Bruenings  
682-12-05 To 682-17-10  
682-18-06 Set of 6 (682-12-05 To 682-17-10)

$\frac{1}{4}$    
682-12-05  
No. 0  
5.5 mm Ø

$\frac{1}{4}$    
682-13-06  
No. 1  
6.5 mm Ø

$\frac{1}{4}$    
682-14-07  
No. 2  
7.5 mm Ø

$\frac{1}{4}$    
682-15-08  
No. 3  
8.5 mm Ø

$\frac{1}{4}$    
682-16-09  
No. 4  
9.5 mm Ø

$\frac{1}{4}$    
682-17-10  
No. 5  
10.5 mm Ø



Bruenings  
682-19-00  
Complete with 4 Bruenings  
specula packed in woode case

Ohrspekula, Stimmgabeln  
 Ear Specula, Tuning Forks  
 Spéculums auriculaires, Diapasons



- |   |   |   |
|---|---|---|
| $\frac{1}{4}$  | $\frac{1}{4}$  | $\frac{1}{4}$  |
| <b>683-01-06</b><br>No. 1<br>6 mm Ø   | <b>683-02-06</b><br>No. 2<br>6.5 mm Ø   | <b>683-03-07</b><br>No. 3<br>7.5 mm Ø   |

Siegle  
 683-01-06 To 683-03-07  
 683-04-03  
 Set of 3 (683-01-06 To 683-03-07)



Siegle  
**683-05-00**  
 Complete set with  
 3 Siegle specula packed  
 in wooden case



$\frac{1}{2}$   
 Hartmann  
**683-06-128**  
 c 128



$\frac{1}{2}$   
 Hartmann  
**683-07-256**  
 c' 256



$\frac{1}{2}$   
 Hartmann  
**683-08-512**  
 c² 512



$\frac{1}{2}$   
 Hartmann  
**683-09-1024**  
 c³ 1024



$\frac{1}{2}$   
 Hartmann  
**683-10-2048**  
 c 2048



$\frac{1}{2}$   
 Hartmann  
**683-11-4096**  
 c⁵ 4096

Stimmgabeln  
Tuning Forks  
Diapasons



1/2

Hartmann  
684-01-64  
c 64



1/2

Hartmann  
684-02-128  
c 128



1/2

Hartmann  
684-03-256  
c' 256



1/2

684-04-440  
a' 440



Lucae  
684-05-128  
c 128



Lucae  
684-06-256  
c' 256



Lucae  
684-07-512  
c<sup>2</sup> 512



Lucae  
684-08-1024  
c<sup>3</sup> 1024



Lucae  
684-09-2048  
c<sup>4</sup> 2048



Lucae  
684-10-4096  
c<sup>5</sup> 4096

Stimmgabeln  
Tuning Forks  
Diapasons



1/2

French  
685-05-16  
c\_ 16



1/2

French  
685-06-32  
c\_ 32



Alu  
685-01-512  
c² 512



Alu  
685-02-1024  
c³ 1024



Alu  
685-03-2048  
c 2048



Alu  
685-04-4096  
c 4096



Alu  
685-07-64  
c 64



Alu  
685-08-128  
c 128



Alu  
685-09-256  
c¹ 256

Stimmgabeln  
Tuning Forks  
Diapasons



Gardiner-Brown  
686-01-128  
c 128



Gardiner-Brown  
686-02-256  
c' 256



Gardiner-Brown  
686-03-512  
c² 512



Gardiner-Brown  
686-04-1024  
c³ 1024



Gardiner-Brown  
686-05-2048  
c⁴ 2048



Gardiner-Brown  
686-06-435  
a¹ 435

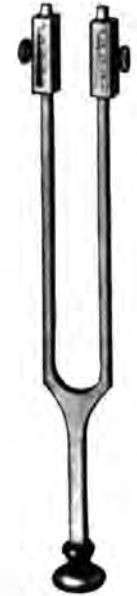

Rydel-Seiffer  
686-07-128  
c 64/c 128

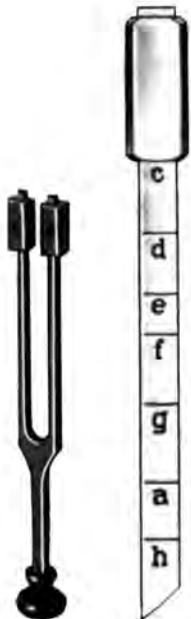

Lucae  
686-08-128  
c 128



Koenig  
686-09-109  
a 109



1/2  
Hartmann  
686-10-128  
c 128



1/2  
Hartmann  
686-11-256  
c' 256



1/2  
686-12-00  
Tuning fork for  
neurology

**Stimmgabeln  
Tuning Forks  
Diapasons**



Hartmann  
**687-01-05**  
Complete set packed in wooden case  
consisting :  
1 Hartmann tuning fork c 128  
1 Hartmann tuning fork c<sup>1</sup> 256  
1 Hartmann tuning fork c<sup>2</sup> 512  
1 Hartmann tuning fork c<sup>3</sup> 1024  
1 Hartmann tuning fork c 2048



Hartmann  
**687-02-08**  
Complete set packed in wooden case  
consisting :  
1 Hartmann tuning fork c 64  
1 Hartmann tuning fork c 128  
1 Hartmann tuning fork c<sup>1</sup> 32  
1 Hartmann tuning fork c<sup>1</sup> 256  
1 Hartmann tuning fork c<sup>2</sup> 512  
1 Hartmann tuning fork c<sup>3</sup> 1024  
1 Hartmann tuning fork c 2048  
1 Hartmann tuning fork c 4096



Alu  
**687-03-05**  
Complete set packed in wooden case  
consisting :  
1 Alu tuning fork c 128  
1 Alu tuning fork c<sup>1</sup> 256  
1 Alu tuning fork c<sup>2</sup> 512  
1 Alu tuning fork c<sup>3</sup> 1024  
1 Alu tuning fork c 2048

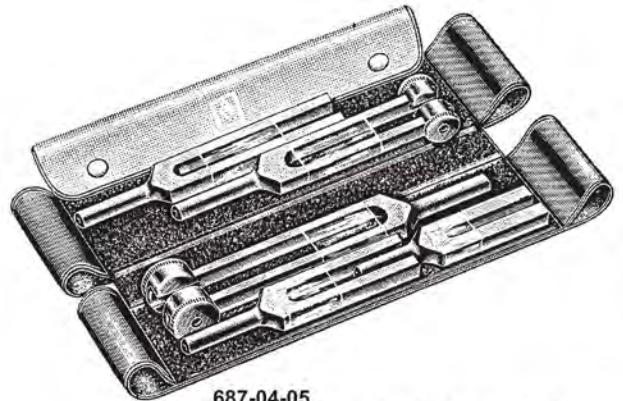

**687-04-05**  
Complete set packed in plastic pouch  
consisting :  
1 Alu tuning fork c 128  
1 Alu tuning fork c<sup>1</sup> 256  
1 Alu tuning fork c<sup>2</sup> 512  
1 Alu tuning fork c<sup>3</sup> 1024  
1 Alu tuning fork c 2048





**Mikro-Ohrmesser, Mikro-Ohrnadeln  
Knives  
Micro Couteaux auriculaires, Micro Aghi auricolari**

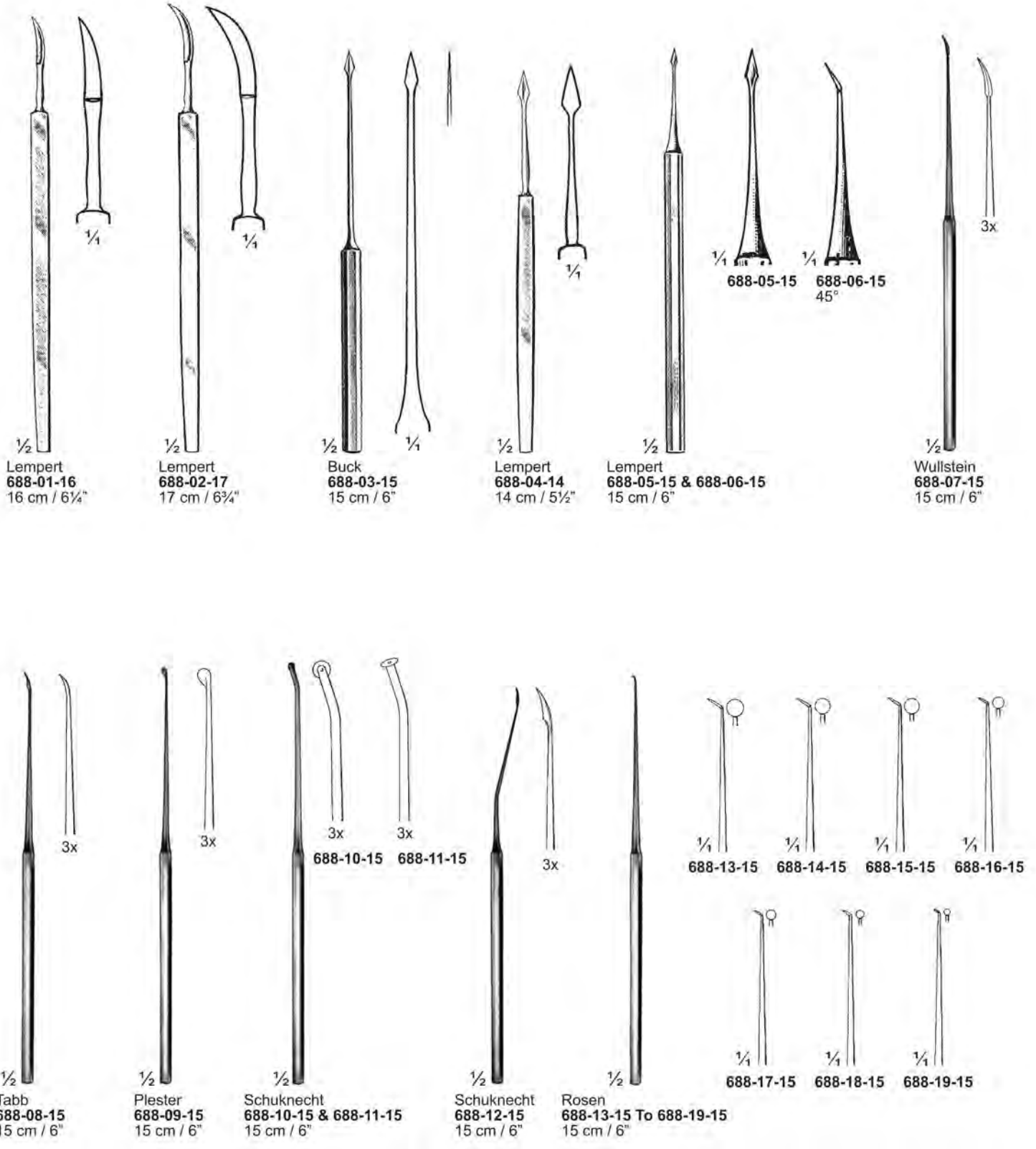

1/2  
Lempert  
688-01-16  
16 cm / 6 1/4"

1/2  
Lempert  
688-02-17  
17 cm / 6 3/4"

1/2  
Buck  
688-03-15  
15 cm / 6"

1/2  
Lempert  
688-04-14  
14 cm / 5 1/2"

1/2  
Lempert  
688-05-15 & 688-06-15  
15 cm / 6"

1/2  
Wullstein  
688-07-15  
15 cm / 6"

1/2  
Tabb  
688-08-15  
15 cm / 6"

1/2  
Plester  
688-09-15  
15 cm / 6"

1/2  
Schuknecht  
688-10-15 & 688-11-15  
15 cm / 6"

1/2  
Schuknecht  
688-12-15  
15 cm / 6"

1/2  
Rosen  
688-13-15 To 688-19-15  
15 cm / 6"

**Mikro-Ohrmesser**  
**Micro Ear Knives**  
**Micro Couteaux auriculaires**



1/2  
**Muck**  
**689-01-13**  
 13.5 cm / 5 1/2"



1/2  
**Poltzer**  
**689-02-13**  
 13.5 cm / 5 1/2"



1/2  
**Bruehl**  
**689-03-15**  
 15 cm / 6"



1/2  
**Bruehl**  
**689-04-15**  
 15 cm / 6"



1/2  
**Reiner**  
**689-05-19**  
 19 cm / 7 1/2"

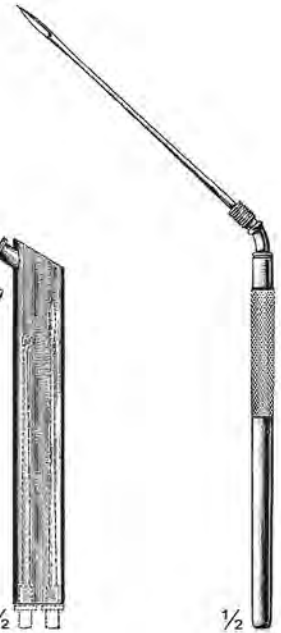

1/2  
**Gerzog**  
**689-06-16**  
 16 cm / 6 1/4"



1/2  
**Friesner**  
**689-07-16**  
 16 cm / 6 1/4"



1/2  
**Dench**  
**689-08-16**  
 16 cm / 6 1/4"



1/2  
**Buck**  
**689-09-16**  
 16 cm / 6 1/4"



1/2  
**Poltzer**  
**689-10-16**  
 16 cm / 6 1/4"



1/2  
**689-11-19 To 689-15-19**  
 19 cm / 7 1/2"



1/4  
**Royce**  
**689-11-19**



1/4  
**Royce**  
**689-12-19**



1/4  
**Sexton**  
**689-13-19**



1/4  
**Dintenfass**  
**689-14-19**



1/4  
**Poltzer**  
**689-15-19**



1/2

**Trommelfellnadein  
Tympanum Needles  
Aiguilles pour le tympan**

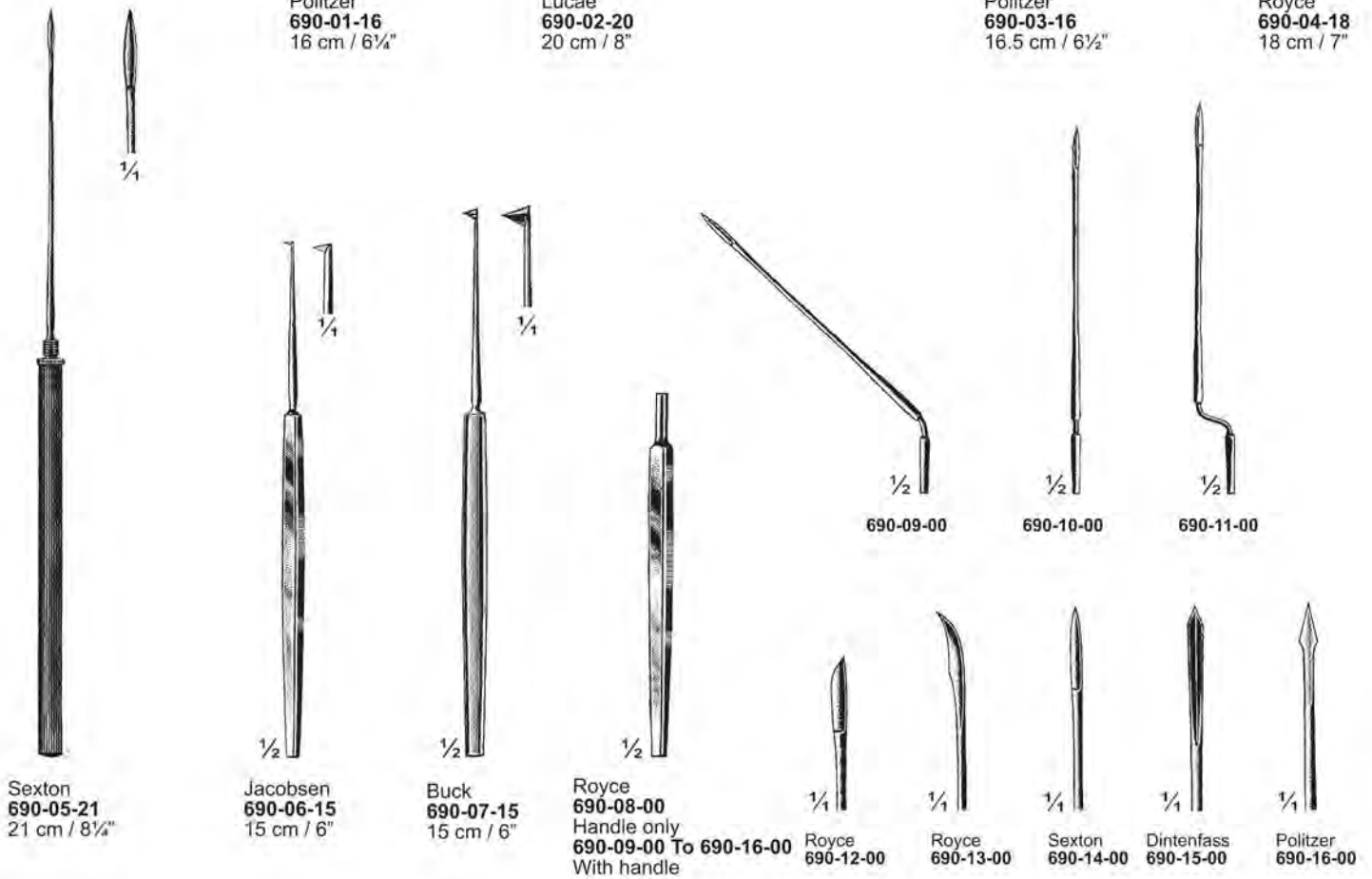
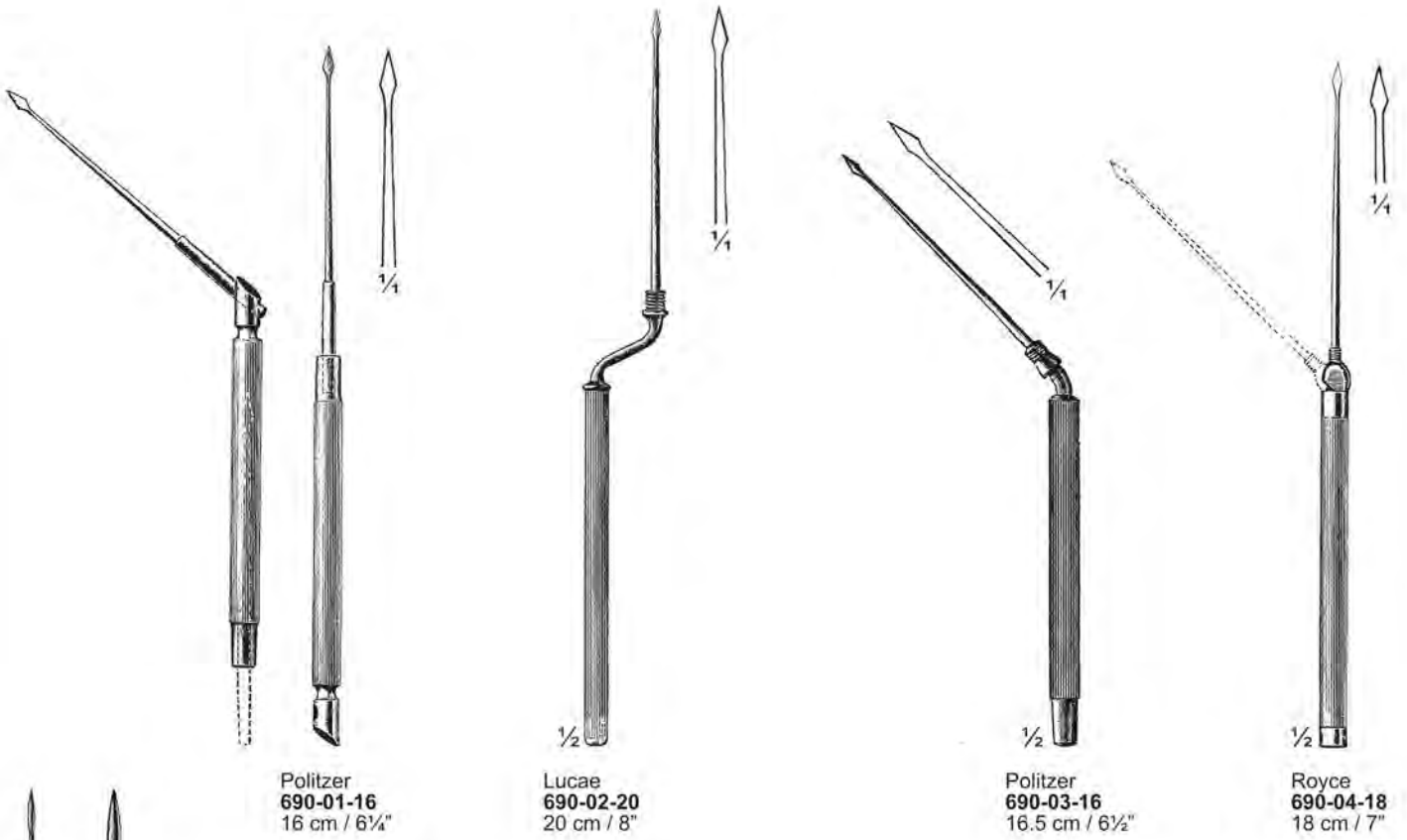

**Trommelfellnadeln  
Tympanum Needles  
Aiguilles pour le tympan**



Lempert  
691-01-16  
16.5 cm / 6½"



Poltzer  
691-02-16  
16 cm / 6¼"

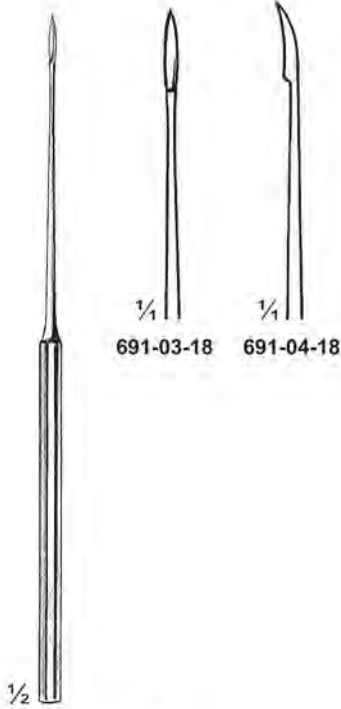

Sexton  
691-03-18 & 691-04-18  
18 cm / 7"



Sexton  
691-05-18  
18 cm / 7"



Gerzog-Sexton  
691-06-17  
17 cm / 6¾"



Locae (Royce)  
691-07-18  
18 cm / 7"



Locae (Royce)  
691-08-18  
18 cm / 7"

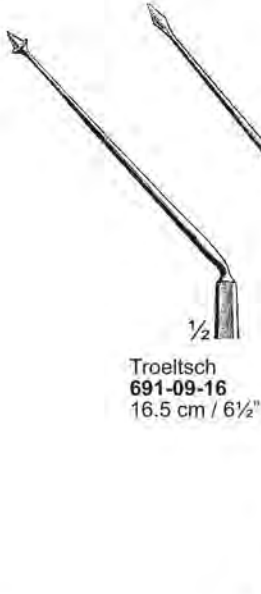

Troeltsch  
691-09-16  
16.5 cm / 6½"

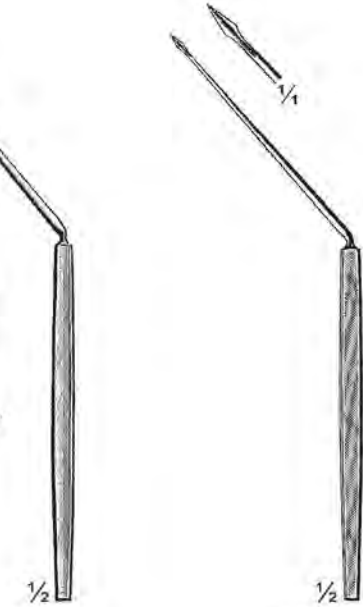

Poltzer  
691-10-16  
16.5 cm / 6½"

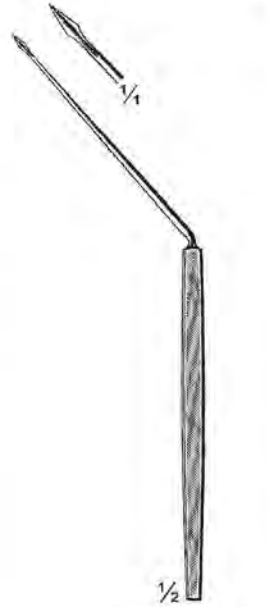







Poltzer  
691-11-16  
16.5 cm / 6½"



Sexton  
691-12-17  
17 cm / 6¾"

**Trommelfellnadein  
Tympanum Needles  
Aiguilles pour le tympan**







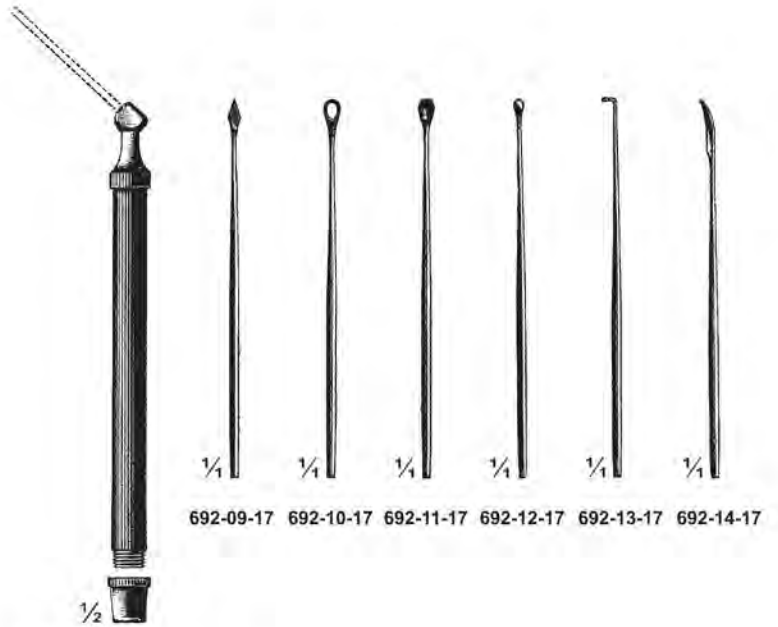

- |   |   |   |  |   |   |   |
|---|---|---|--|---|---|---|
|  |  |  |  |  |  |  |
| 692-01-16   | 692-02-16   | 692-03-16   | 692-04-16  | 692-05-16   | 692-06-16   | 692-07-16   |

Hartmann  
692-01-16 To 692-07-16  
16.5 cm / 6 1/2"  
692-08-00  
Complete set consisting:  
1 Handle and 7 tips



Hartmann  
692-16-00  
Complete set consisting:  
1 Handle and 13 tips



- |   |   |   |   |   |   |
|---|---|---|---|---|---|
|  |  |  |  |  |  |
| 692-09-17   | 692-10-17   | 692-11-17   | 692-12-17   | 692-13-17   | 692-14-17   |

Sprague  
692-09-17 To 692-14-17  
17 cm / 6 3/4"  
692-15-00  
Complete set consisting:  
1 Handle and 6 tips



**Mikro-Ohräkchen, Mikro-Ohrnadeln  
Micro Ear Hooks, Micro Ear Needles  
Micro Crochets auriculaires, Micro Aiguilles auriculaires**



**693-01-15 To 693-24-15**  
15 cm / 6"



**693-01-15** 0.3 mm  
**693-02-15** 0.6 mm  
**693-03-15** 1.0 mm  
90°



**693-04-15** 0.3 mm  
**693-05-15** 0.6 mm  
**693-06-15** 1.0 mm  
90°



McGee  
**693-07-15** 0.5 mm  
**693-08-15** 1.0 mm



McGee  
**693-09-15** 0.5 mm  
**693-10-15** 1.0 mm



Barbara  
**693-11-15**



Rosen  
**693-12-15**



**693-13-15** 0.3 mm  
**693-14-15** 0.6 mm  
**693-15-15** 1.0 mm  
25°



**693-16-15** 0.3 mm  
**693-17-15** 0.6 mm  
**693-18-15** 1.0 mm  
25°



**693-19-15** 0.3 mm  
**693-20-15** 0.6 mm  
**693-21-15** 1.0 mm  
45°



**693-22-15** 0.3 mm  
**693-23-15** 0.6 mm  
**693-24-15** 1.0 mm  
45°



Barbara  
**693-25-15 To 693-47-15**  
15 cm / 6"



**693-25-15**



**693-26-15**



**693-27-15**



Rosen  
**693-28-15**



**693-29-15** 0.3 mm  
**693-30-15** 0.6 mm  
**693-31-15** 1.0 mm  
25°



**693-32-15** 0.3 mm  
**693-33-15** 0.6 mm  
**693-34-15** 1.0 mm  
**693-35-15** 1.2 mm  
**693-36-15** 1.5 mm  
**693-37-15** 2.0 mm  
**693-38-15** 2.5 mm  
45°



**693-39-15** 0.3 mm  
**693-40-15** 0.6 mm  
**693-41-15** 1.0 mm  
**693-42-15** 1.2 mm  
**693-43-15** 1.5 mm  
**693-44-15** 2.0 mm  
**693-45-15** 2.5 mm  
90°



**693-46-15** 0.3 mm  
**693-47-15** 1.0 mm

Mikro-Dissektoren  
Micro Dissectors  
Micro Dissecteurs

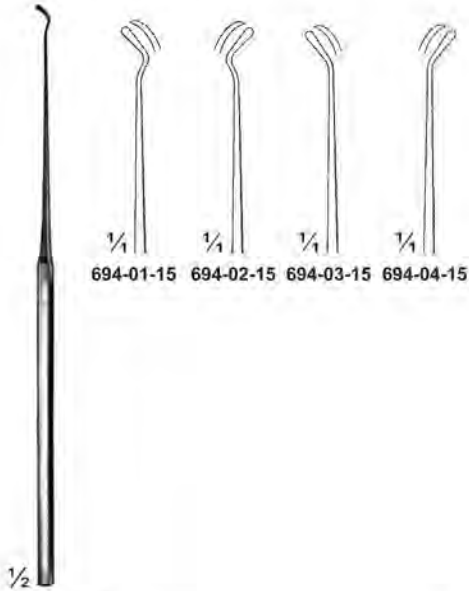

Fisch  
694-01-15 To 694-04-15  
15 cm / 6"

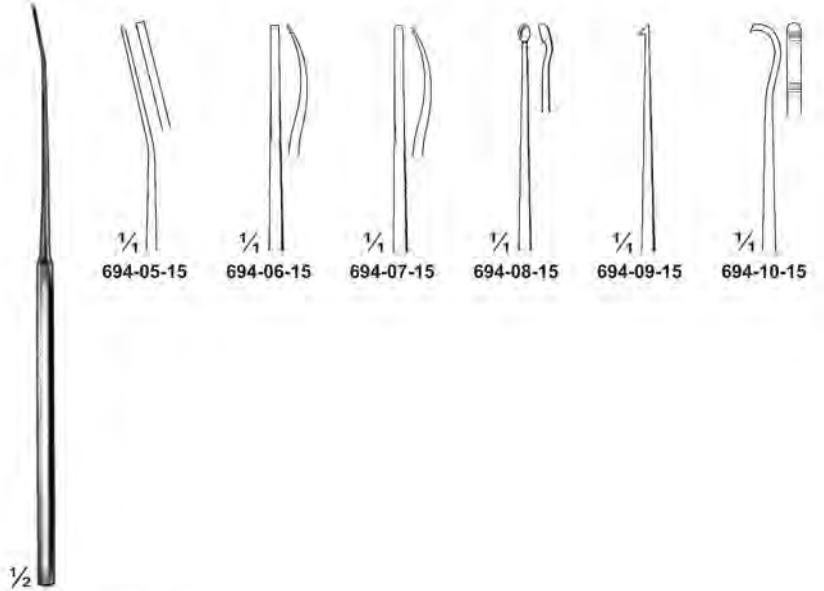

Rosen  
694-05-15 To 694-10-15  
15 cm / 6"

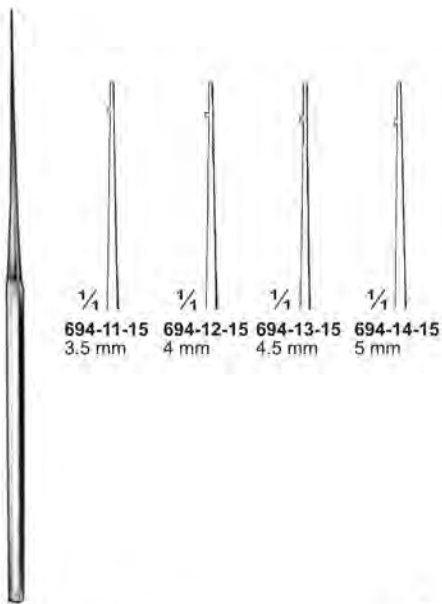

House  
694-11-15 To 694-14-15  
15 cm / 6"

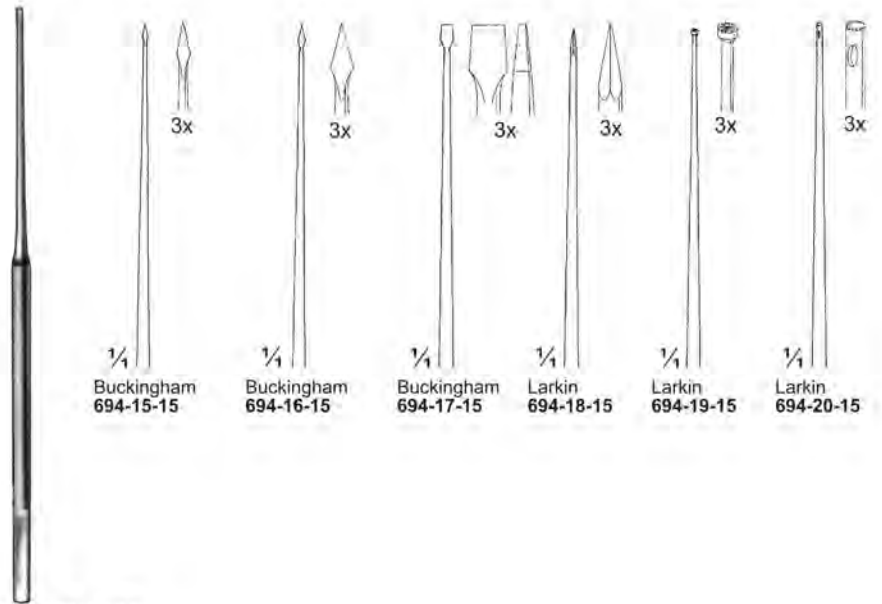

694-15-15 To 694-20-15  
15 cm / 6"



**Bezahlen Sie Platten Hände Instrumente**  
**Foot Plate Hand Instruments**  
**Payer Les Instruments De Main De Plaque**



AA	AA
1.0 mm	1.5 mm
1.2 mm	1.8 mm
1/4 BB	1/4 BB
<b>695-01-14</b>	<b>695-02-14</b>

House  
**695-01-14 & 695-02-14**  
 14 cm / 5 1/2"



AA	AA
1.0 mm	1.5 mm
1.2 mm	1.8 mm
1/4 BB	1/4 BB
<b>695-03-14</b>	<b>695-04-14</b>

House  
**695-03-14 & 695-04-14**  
 14 cm / 5 1/2"



1/4 AA  
 1.5 mm

1/2

Shea  
**695-05-11**  
 11 cm / 4 1/4"



**695-06-18**  
 18 cm / 7"



**695-07-07**  
 7 cm / 2 3/4"  
 Handle for  
 items 695-08-07 To 695-14-07



**695-08-07**  
 7 cm / 2 3/4"



**695-09-07**  
 7 cm / 2 3/4"



**695-10-07**  
 7 cm / 2 3/4"



**695-11-07**  
 7 cm / 2 3/4"



**695-12-07**  
 7 cm / 2 3/4"



**695-13-07**  
 7 cm / 2 3/4"



**695-14-07**  
 7 cm / 2 3/4"





Ohrküretten, Ohrlöffel  
 Ear Cures, Ear Scoop  
 Cures auriculaires, Curette auriculaire

	 Blunt	 1/4 696-01-16 No. 000	 1/4 696-02-16 No. 00	 1/4 696-03-16 No. 0	 1/4 696-04-16 No. 1	 1/4 696-05-16 No. 2	 1/4 696-06-16 No. 3	 1/4 696-07-16 No. 4
	 Sharp	 1/4 696-08-16 No. 000	 1/4 696-09-16 No. 00	 1/4 696-10-16 No. 0	 1/4 696-11-16 No. 1	 1/4 696-12-16 No. 2	 1/4 696-13-16 No. 3	 1/4 696-14-16 No. 4
	 Blunt	 1/4 696-15-16 No. 000	 1/4 696-16-16 No. 00	 1/4 696-17-16 No. 0	 1/4 696-18-16 No. 1	 1/4 696-19-16 No. 2	 1/4 696-20-16 No. 3	 1/4 696-21-16 No. 4
	 Sharp	 1/4 696-22-16 No. 000	 1/4 696-23-16 No. 00	 1/4 696-24-16 No. 0	 1/4 696-25-16 No. 1	 1/4 696-26-16 No. 2	 1/4 696-27-16 No. 3	 1/4 696-28-16 No. 4

Buck  
 696-01-16 To 696-28-16  
 16.5 cm / 6 1/2"



Langenbeck  
 696-29-13  
 13 cm / 5 1/8"



Coxeter  
 696-30-14  
 14.5 cm / 5 3/4"



Shapleigh  
 696-31-13 To 696-34-13  
 13 cm / 5 1/8"

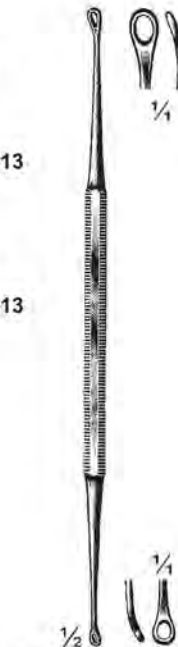
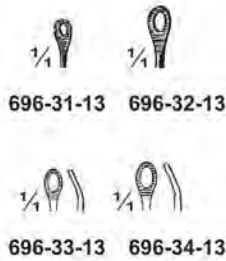

696-35-17 Blunt  
 696-36-17 Sharp  
 17 cm / 6 3/4"



696-37-15  
 15 cm / 6"  
 Sharp



696-38-18  
 18 cm / 7"  
 Sharp

**Ohrküretten, Ohrlöffel  
Ear Cures, Ear Scoop  
Curettes auriculaires, Curette auriculaire**

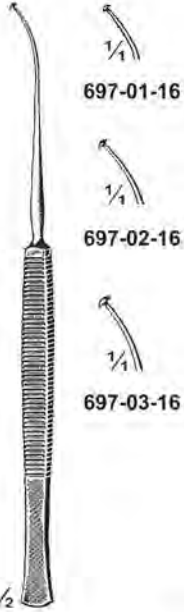

**Yankauer**  
697-01-16 To 697-03-16  
16 cm / 6¼"



**Wolf**  
697-04-16  
16 cm / 6¼"  
Sharp



**Bishop**  
697-05-16 To 697-08-16  
16 cm / 6¼"  
Sharp



**House**  
697-09-15  
15 cm / 6"



**Antoli-Candela**  
697-10-15  
15 cm / 6"



**Rosier**  
697-11-14  
14 cm / 5½"  
Blunt



**Gross**  
697-12-12  
12 cm / 4¾"  
Sharp/Blunt



**Gross**  
697-13-12  
12 cm / 4¾"  
Blunt



**Gross**  
697-14-12  
12 cm / 4¾"  
Blunt



**Gross**  
697-15-12  
12 cm / 4¾"  
Sharp/Blunt



**Gross**  
697-16-12  
12 cm / 4¾"  
Blunt

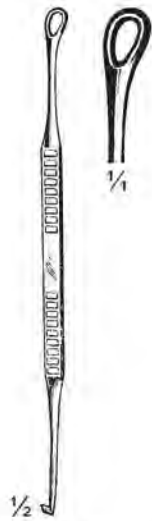

**Gardner-Brown**  
697-17-14  
14 cm / 5½"

**Ohrküretten, Ohrlöffel**  
**Ear Cures, Ear Scoop**  
**Curettes auriculaires, Curette auriculaire**

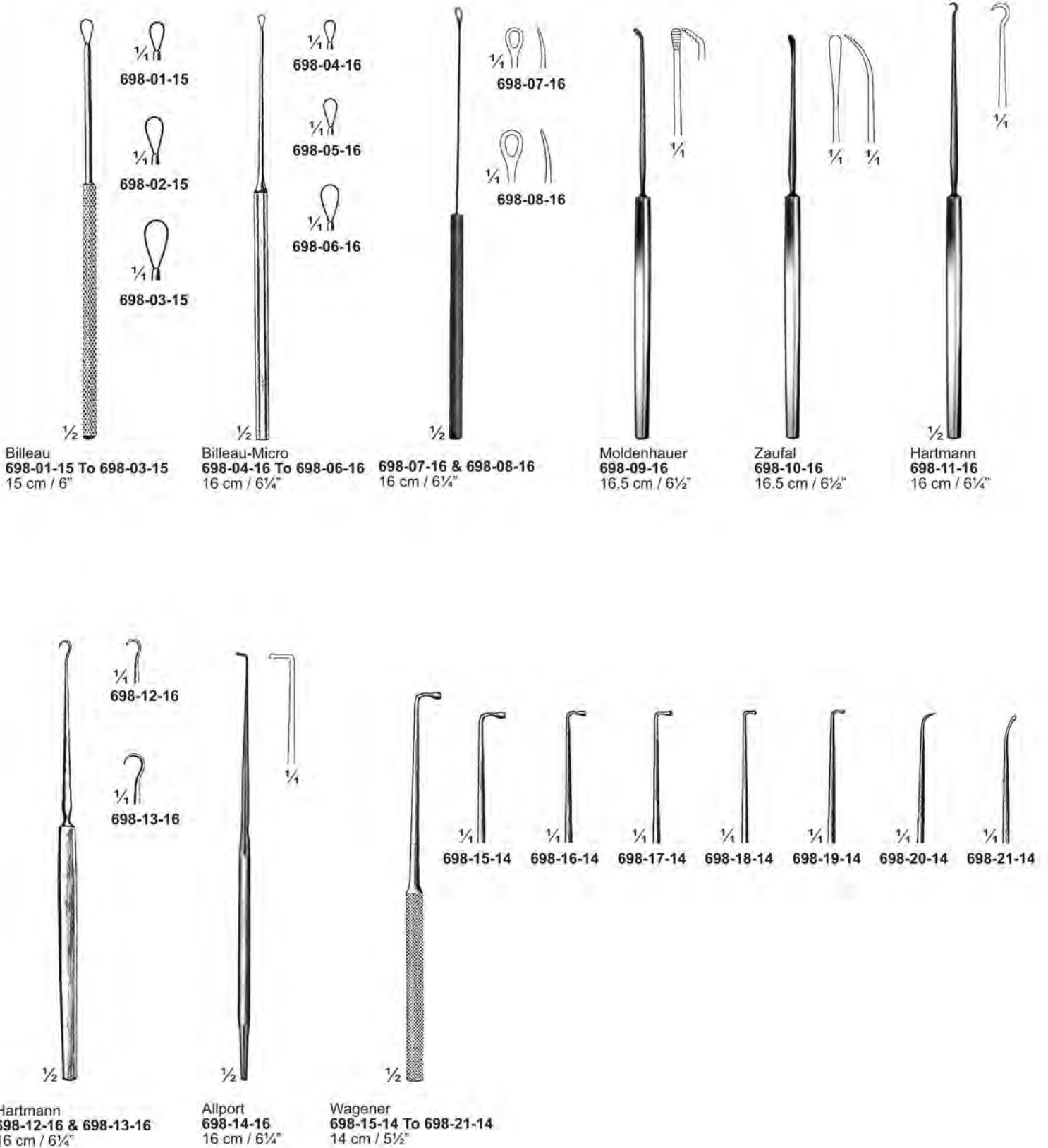

Ohrhäkchen  
Ear Hooklets  
Crochets auriculaires

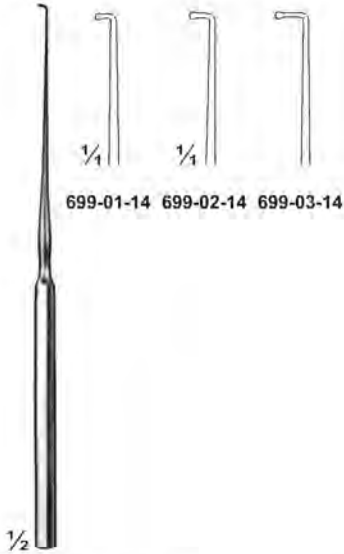

Lucae  
699-01-14 To 699-03-14  
14 cm / 5 1/2"



Jansen  
699-04-15 & 699-05-15  
15 cm / 6"



Yankauer-Jansen  
699-06-15  
15 cm / 6"



Yankauer  
699-07-16  
16.5 cm / 6 1/2"



Day  
699-08-16 & 699-09-16  
16 cm / 6 1/4"



699-08-16

699-09-16



1/4"



Stacke  
699-10-11  
11 cm / 4 1/4"



Holz  
699-11-13  
13.5 cm / 5 1/4"



Jansen-Newhart  
699-12-17  
17 cm / 6 3/4"



Lucae  
699-13-19  
19 cm / 7 1/2"

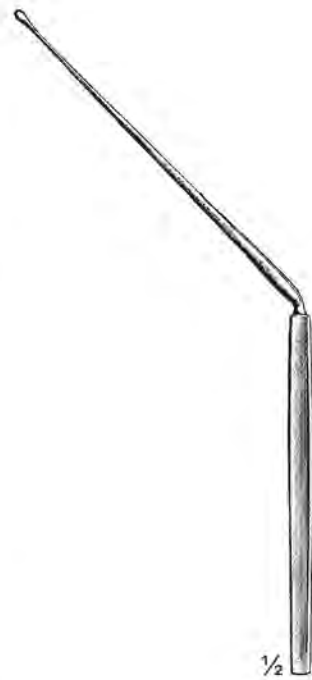

Troeltsch  
699-14-20  
20 cm / 8"



Wullstein  
699-15-26  
26 cm / 10 1/4"

# Ohrraspatorien Elevators Rugines-raspatoires auriculaires

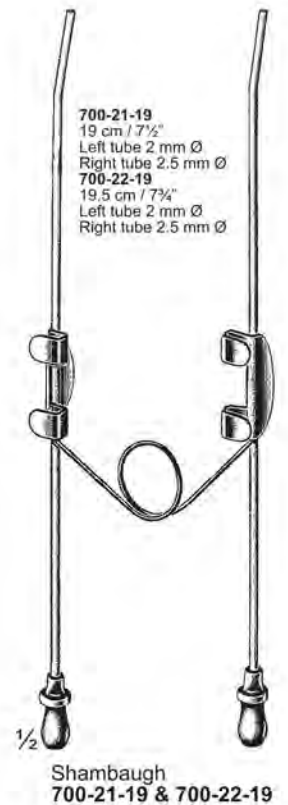
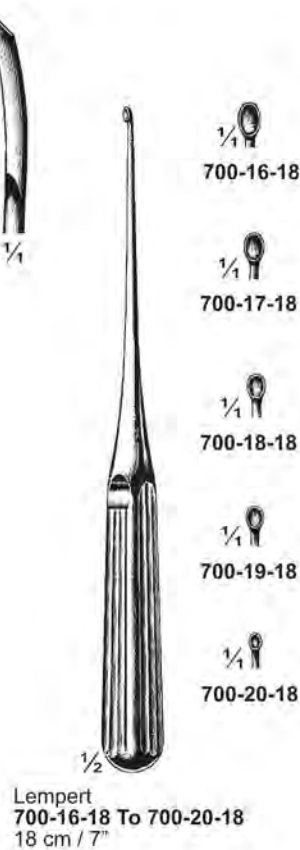
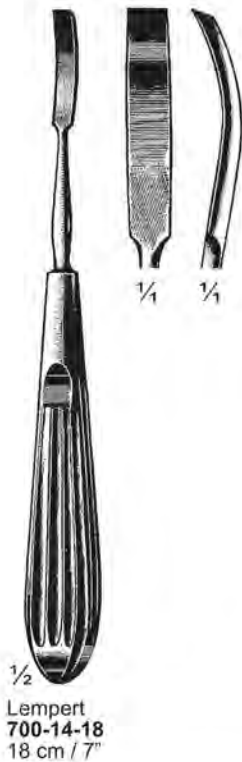
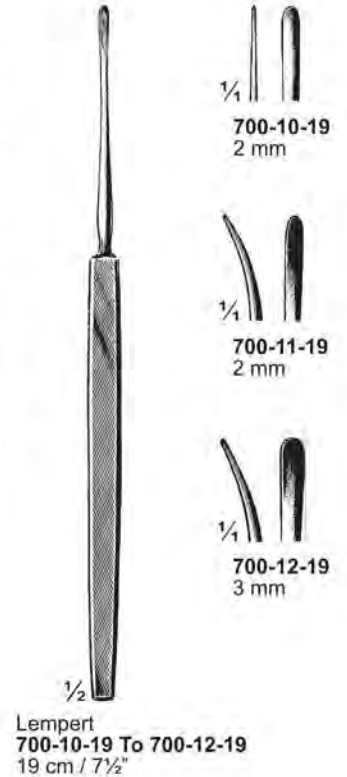
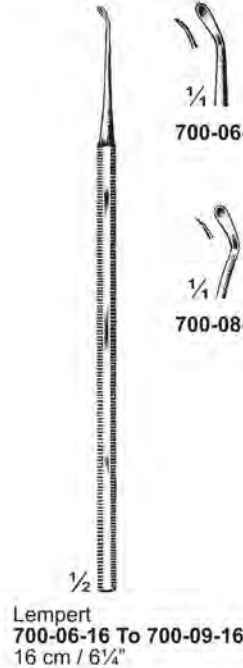
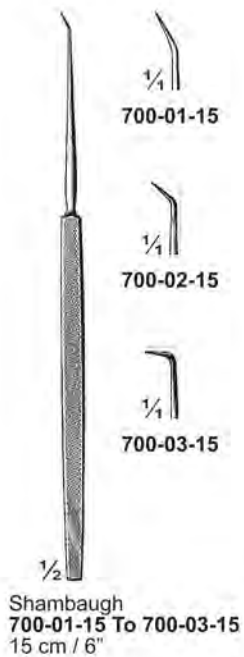



**Pulverbläser, Ohrspritzen  
Atomizers, Ear Syringes  
Lance-poudre, Seringues auriculaires**

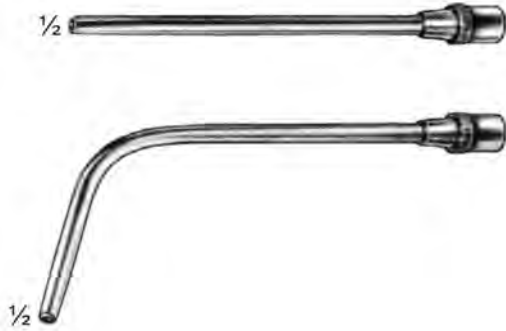

$\frac{1}{2}$   
Kabierske  
**701-01-30**  
30 ccm  
complete with 3 cannulas  
for nose throat and larynx



$\frac{1}{2}$   
**701-02-50** 50 ml  
**701-03-75** 75 ml  
**701-04-100** 100 ml  
complete with 2 cannulas  
and protecting disk



**701-05-20** 20 ml  
**701-06-30** 30 ml  
complete with 1 cannula



Luer-Lock  
**701-07-50** 50 ml  
**701-08-75** 75 ml  
**701-09-100** 100 ml  
complete with 2 cannulas  
and 1 protecting disk



**701-10-50** 50 ml  
**701-11-75** 75 ml  
**701-12-100** 100 ml  
complete with 3 cannulas  
and 1 protecting disk



Bowman  
702-01-07  
7 cm / 2¾"

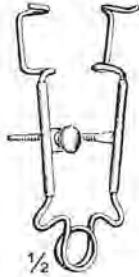

Critchett  
702-02-07  
7 cm / 2¾"



Graefe  
702-03-07 Infants  
7 cm / 2¾"  
702-04-09 Adults  
9 cm / 3½"

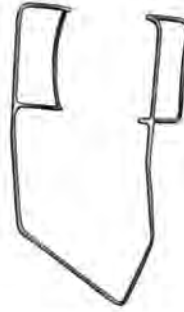

Barraquer (Colibri)  
702-05-07 Infants  
7 cm / 2¾"  
702-06-09 Adults  
9 cm / 3½"



Pley  
702-07-06  
6 cm / 2½"



Weiss  
702-08-08  
8 cm / 3¼"



Weiss  
702-09-07 Infants  
7 cm / 2¾"  
702-10-09 Adults  
9 cm / 3½"



Weiss  
702-11-07 Infants  
7 cm / 2¾"  
702-12-09 Adults  
9 cm / 3½"



Weiss  
702-13-07 Infants  
7 cm / 2¾"  
702-14-08 Adults  
8 cm / 3¼"



Weiss  
702-15-08  
8 cm / 3¼"



Ziegler  
702-16-07  
7 cm / 2¾"



Knapp-Clark  
702-17-08  
8 cm / 3¼"



Lister-Burch  
702-18-08  
8 cm / 3¼"



Lancaster  
702-19-07  
7 cm / 2¾"



Sauer  
702-20-03  
3 cm / 1¼"

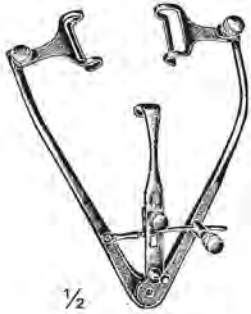

1/2

Guyton-Park  
703-01-08  
8 cm / 3 1/4"



1/2

Mellinger  
703-02-05 Infants  
5 cm / 2"  
703-03-07 Adults  
7 cm / 2 3/4"

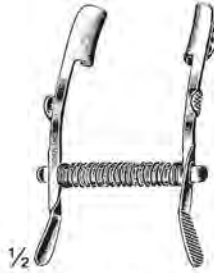

1/2

Mellinger-Beard  
703-04-05 Infants  
5 cm / 2"  
703-05-07 Adults  
7 cm / 2 3/4"

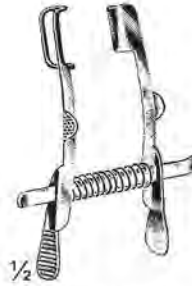

1/2

Mellinger-Axenfeld  
703-06-07  
7 cm / 2 3/4"



1/2

Mellinger-Axenfeld  
703-07-07  
7 cm / 2 3/4"



1/2

Park-Maumenee  
703-08-08  
8 cm / 3 1/4"



1/2

Murdock  
703-09-05  
5 cm / 2"



1/2

Cook  
703-10-04 Infants  
4 cm / 1 1/2"  
703-11-05 Adults  
5 cm / 2"

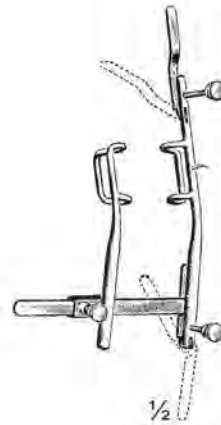

1/2

Arruga  
703-12-07  
7 cm / 2 3/4"



1/2

Arruga  
703-13-07  
7 cm / 2 3/4"

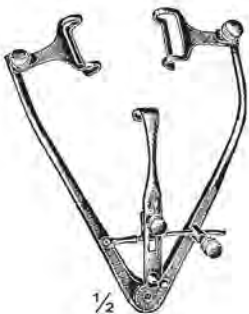

1/2

Park  
703-14-08  
8 cm / 3 1/4"



1/2

Muller  
703-15-07  
7 cm / 2 3/4"



1/2

Stevenson  
703-16-07  
7 cm / 2 3/4"



1/2

Agricola  
703-17-04  
4 cm / 1 1/2"

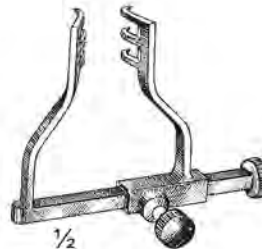

1/2

Goldstein  
703-18-03  
3 cm / 1 1/4"

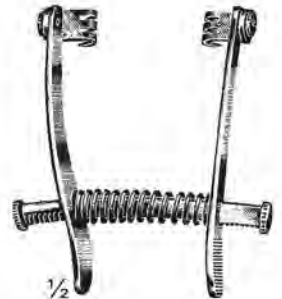

1/2

Axenfeld  
703-19-08  
8 cm / 3 1/4"



Ophthalmic Instrumente  
 Ophthalmic Instruments  
 Instruments Ophthalmiques



Pess  
 704-01-13  
 13 cm / 5 1/8"



Berens  
 704-02-09  
 9 cm / 3 1/2"



Siniscal-Smith  
 704-03-11  
 11 cm / 4 1/2"



704-04-09  
 9 cm / 3 1/2"



Muldoon  
 704-05-08  
 8 cm / 3 1/4"



Schepens  
 704-06-13  
 13 cm / 5 1/8"



Conway  
 704-07-13  
 13 cm / 5 1/8"

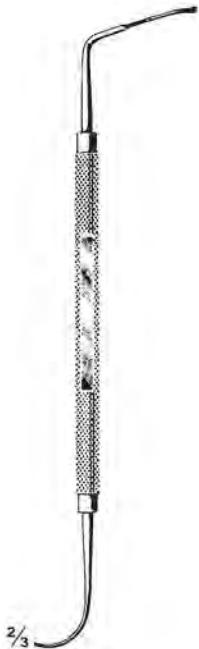

Amenabar  
 704-08-13  
 13 cm / 5 1/8"



Groenholm  
 704-09-13  
 13 cm / 5 1/8"



Desmarres  
 704-10-13  
 13 cm / 5 1/8"



Desmarres  
 704-11-12 To 704-18-18  
 13 cm / 5 1/8"



704-11-12  
 12 mm



704-12-14  
 14 mm



704-13-16  
 16 mm



704-14-18  
 18 mm



704-15-12  
 12 mm



704-16-14  
 14 mm



704-17-17  
 16 mm



704-18-18  
 18 mm

**Ophthalmic Instruments**  
**Ophthalmic Instruments**  
**Instruments Ophthalmiques**



$\frac{2}{3}$   
**Jaeger**  
**705-01-11**  
 11 cm / 4½"  
 Lid plate



$\frac{1}{4}$   
**Castroviejo**  
**705-02-00**  
 Lid plate clamp



$\frac{2}{3}$   
**Berens**  
**705-03-13**  
 13 cm / 5¼"  
 Suture spatula



$\frac{1}{2}$   
**Fink**  
**705-04-08**  
 8 cm / 3¼"  
 Bi-Prong-Marker



$\frac{2}{3}$   
**Scobee**  
**705-05-13**  
 13 cm / 5¼"  
 Muscle hook



$\frac{2}{3}$   
**705-06-13**  
 13 cm / 5¼"



$\frac{2}{3}$   
**705-07-13 To 705-13-13**  
 13.5 cm / 5¼"

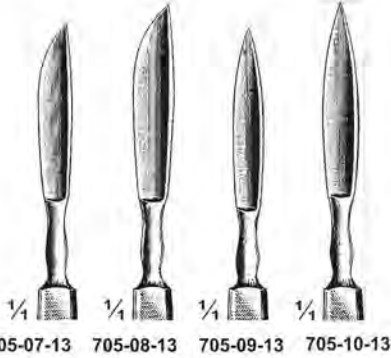

$\frac{1}{4}$   $\frac{1}{4}$   $\frac{1}{4}$   $\frac{1}{4}$   
**705-08-13** **705-09-13** **705-10-13**

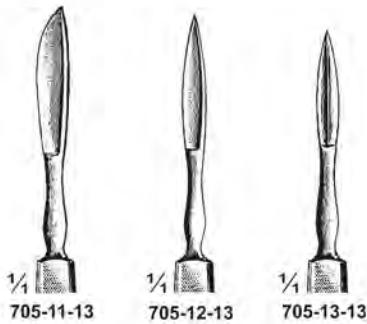

$\frac{1}{4}$   $\frac{1}{4}$   $\frac{1}{4}$   
**705-11-13** **705-12-13** **705-13-13**



$\frac{2}{3}$   
**705-14-13 To 705-25-13**  
 13.5 cm / 5¼"

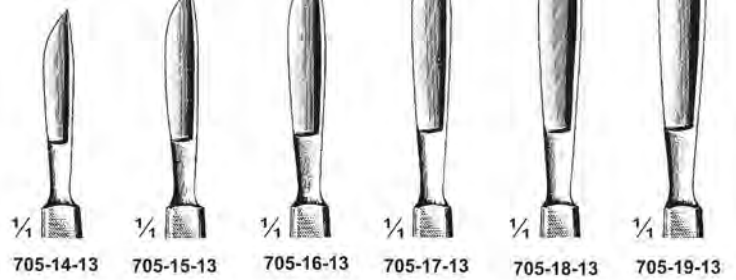

$\frac{1}{4}$   $\frac{1}{4}$   $\frac{1}{4}$   $\frac{1}{4}$   $\frac{1}{4}$   $\frac{1}{4}$   
**705-14-13** **705-15-13** **705-16-13** **705-17-13** **705-18-13** **705-19-13**

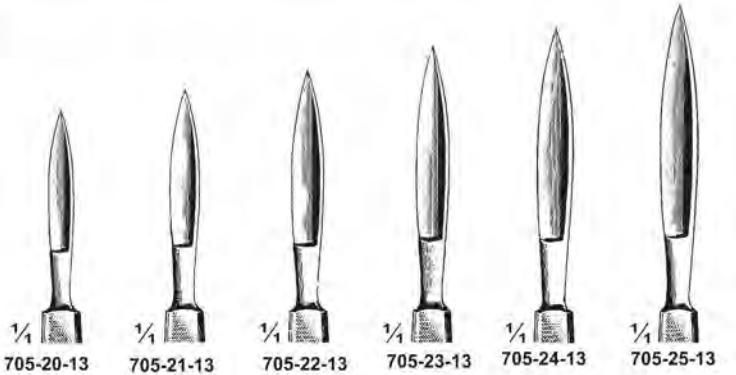

$\frac{1}{4}$   $\frac{1}{4}$   $\frac{1}{4}$   $\frac{1}{4}$   $\frac{1}{4}$   $\frac{1}{4}$   
**705-20-13** **705-21-13** **705-22-13** **705-23-13** **705-24-13** **705-25-13**

Ophthalmic Instrumente  
Ophthalmic Instruments  
Instruments Ophthalmiques



706-01-13 To 706-14-13  
13.5 cm / 5 1/4"



1/4  
Graefe  
706-01-13



1/4  
Graefe  
706-02-13



1/4  
Graefe  
706-03-13



1/4  
Graefe  
706-04-13



1/4  
Graefe  
706-05-13



1/4  
Graefe  
706-06-13



1/4  
Graefe-Arruga  
706-07-13



1/4  
Graefe-Arruga  
706-08-13



1/4  
Graefe-Arruga  
706-09-13



1/4  
Graefe-Arruga  
706-10-13



1/4  
Graefe  
706-11-13



1/4  
Deutschmann  
706-12-13



1/4  
Schmith-Green  
706-13-13



1/4  
Schmith-Green  
706-14-13



Castroviejo  
706-15-09 To 706-17-09  
9 cm / 3 1/2"



1/4  
706-15-09



1/4  
706-16-09



1/4  
706-17-09



Barraquer  
706-18-13  
13.5 cm / 5 1/4"



Beer  
706-19-13  
13.5 cm / 5 1/4"



706-20-13 To 706-22-18  
13.5 cm / 5 1/4"



1/4  
706-20-13  
Right



1/4  
706-21-13  
Left

Berens  
706-20-13 & 706-21-13  
Glaucoma knives



1/4  
Wheeler  
706-22-18  
18 X 1 mm  
Discission knife

**Ophthalmic Instruments  
Ophthalmic Instruments  
Instruments Ophthalmiques**

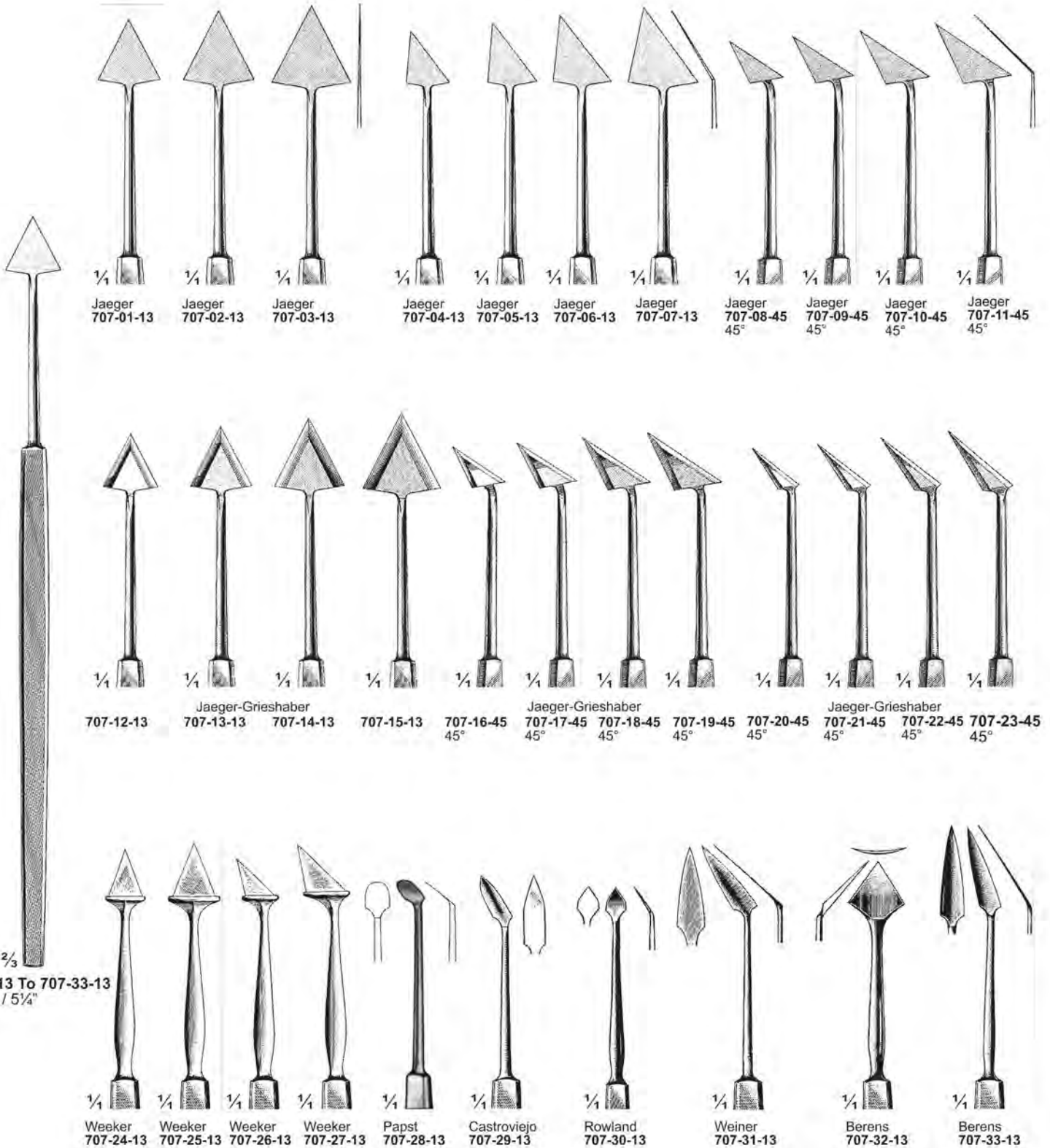

# Ophthalmic Instruments Ophthalmic Instruments Instruments Ophthalmiques

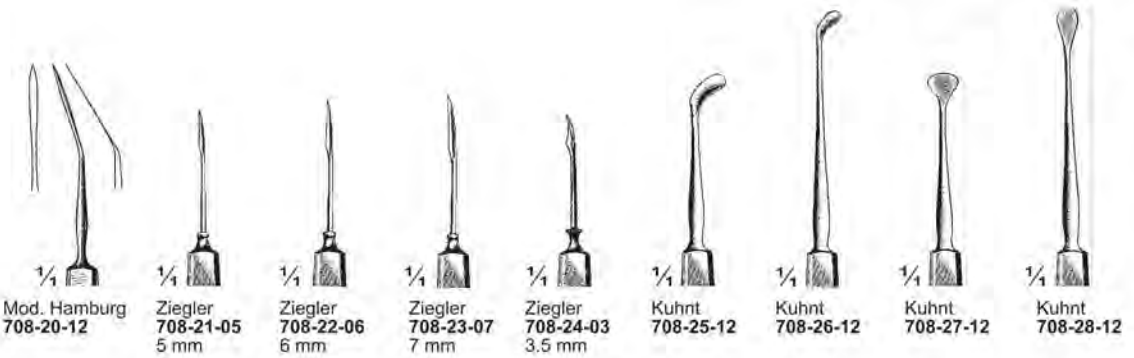
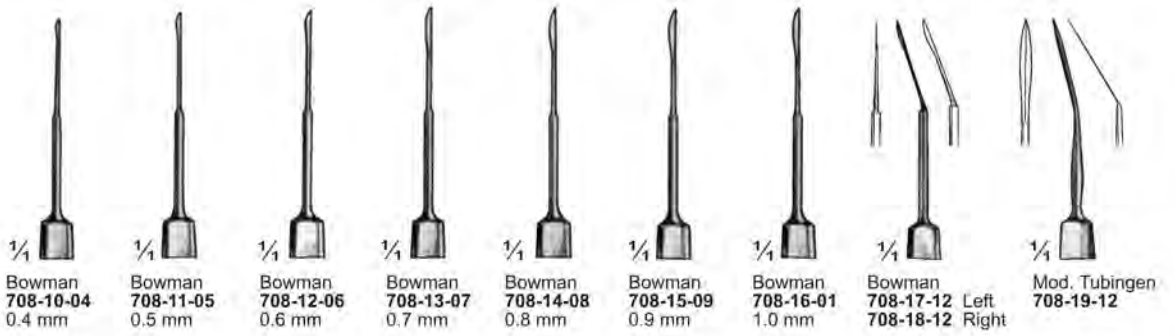
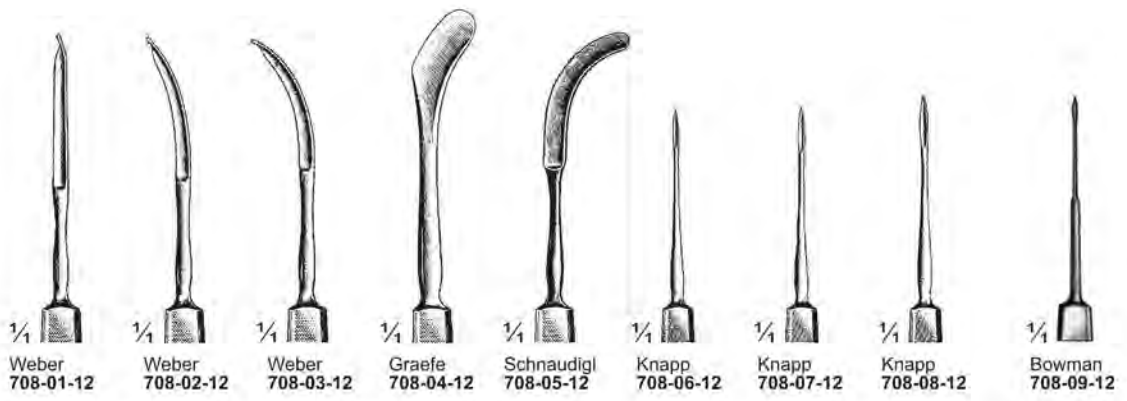

708-01-12 To 708-37-12  
12 cm / 4 3/4"

**Ophthalmic Instrumente  
Ophthalmic Instruments  
Instruments Ophthalmiques**

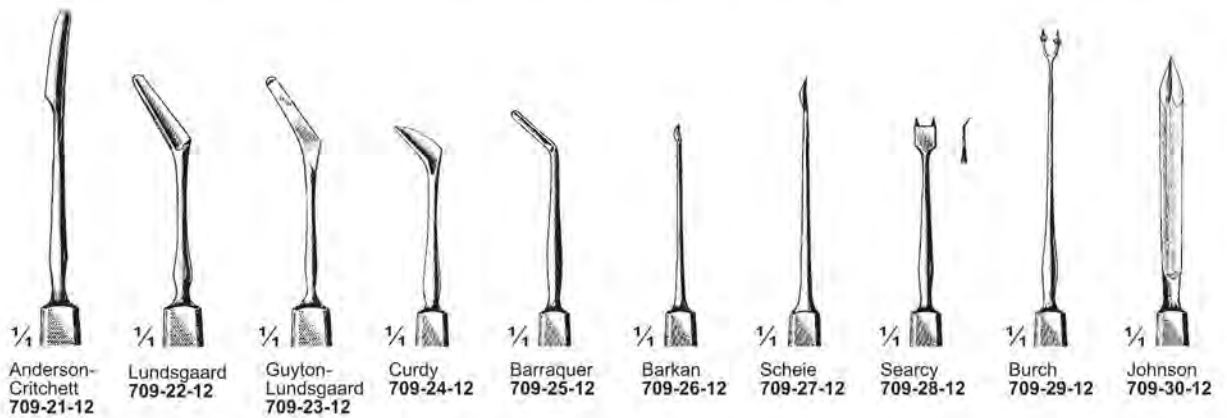
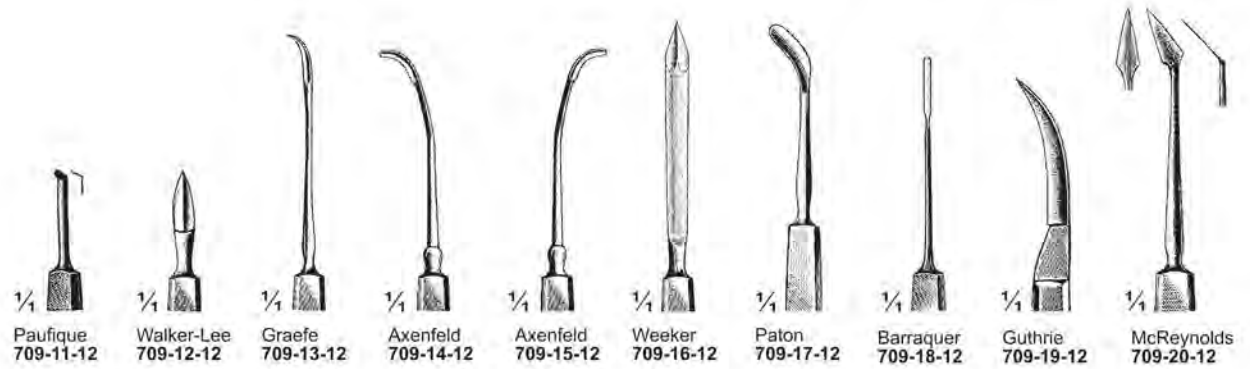
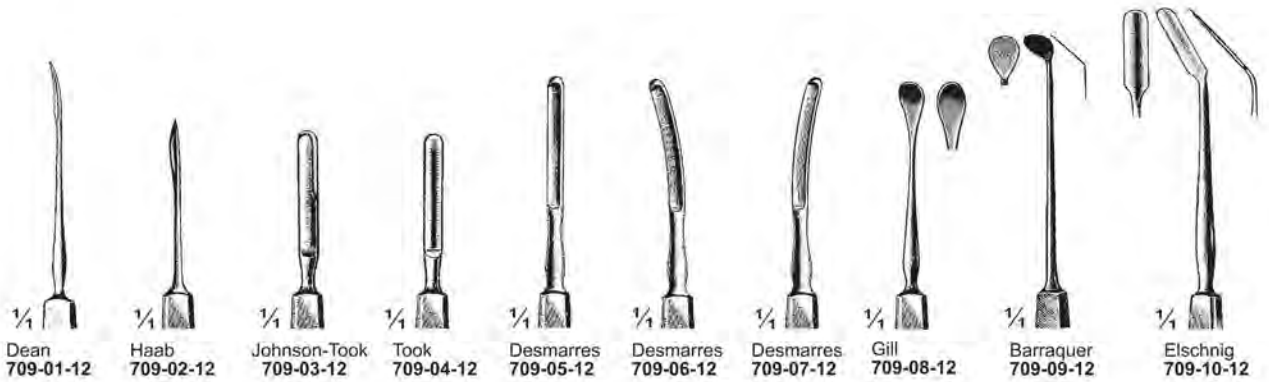

709-01-12 To 709-40-12  
12.5 cm / 5"

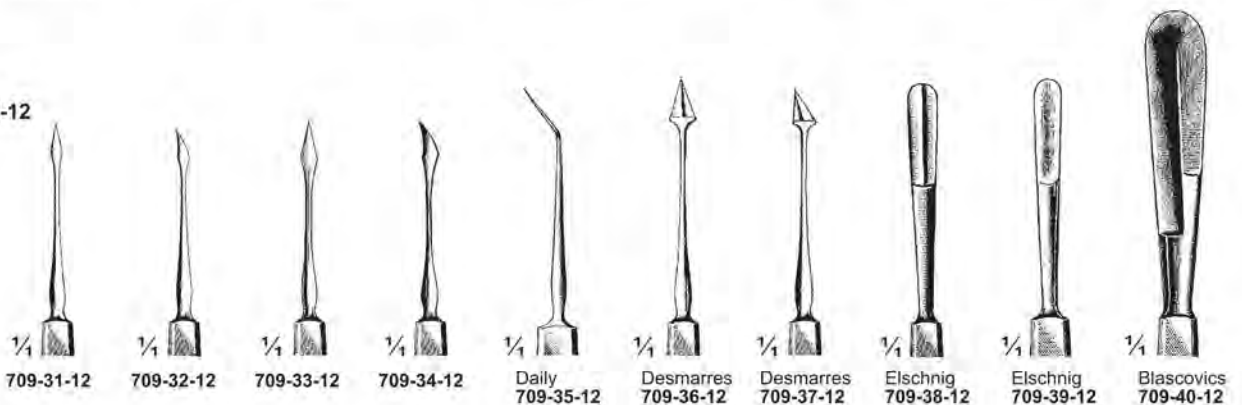

# Ophthalmic Instruments Ophthalmic Instruments Instruments Ophthalmiques

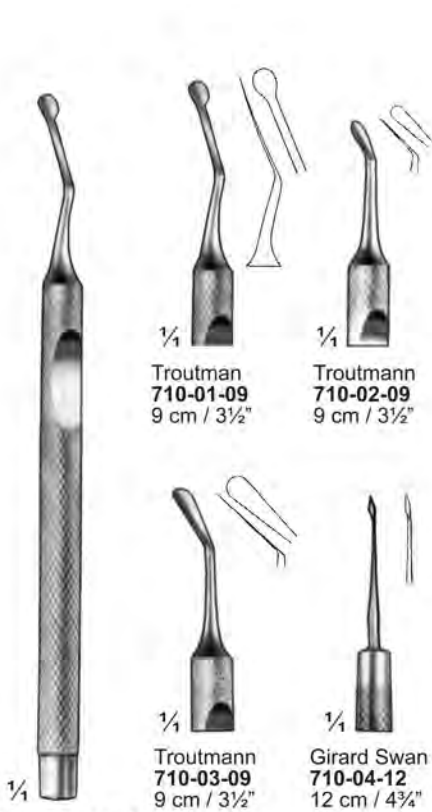

Troutman  
710-01-09  
9 cm / 3½"

Troutman  
710-02-09  
9 cm / 3½"

Troutman  
710-03-09  
9 cm / 3½"

Girard Swan  
710-04-12  
12 cm / 4¾"

710-01-09 To 710-04-12

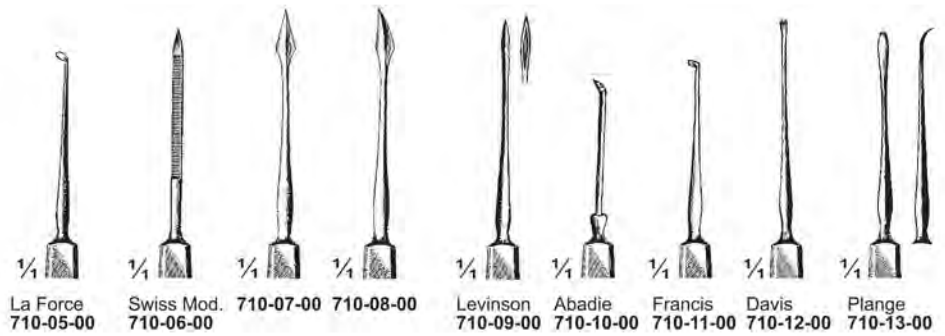

La Force  
710-05-00

Swiss Mod.  
710-06-00

710-07-00

710-08-00

Levinson  
710-09-00

Abadie  
710-10-00

Francis  
710-11-00

Davis  
710-12-00

Plange  
710-13-00

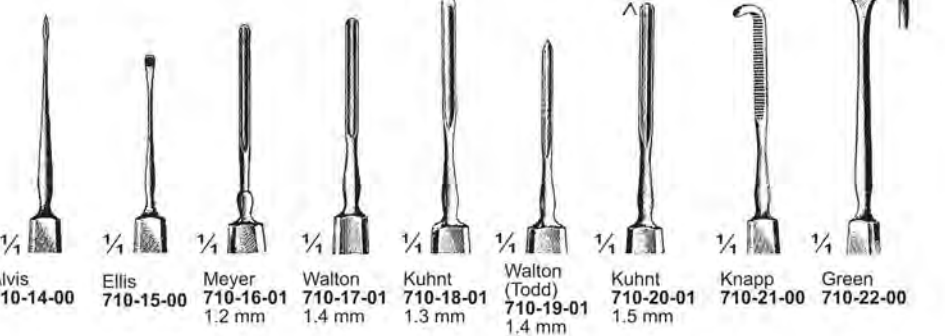

Alvis  
710-14-00

Ellis  
710-15-00

Meyer  
710-16-01  
1.2 mm

Walton  
710-17-01  
1.4 mm

Kuhnt  
710-18-01  
1.3 mm

Walton  
(Todd)  
710-19-01  
1.4 mm

Kuhnt  
710-20-01  
1.5 mm

Knapp  
710-21-00

Green  
710-22-00

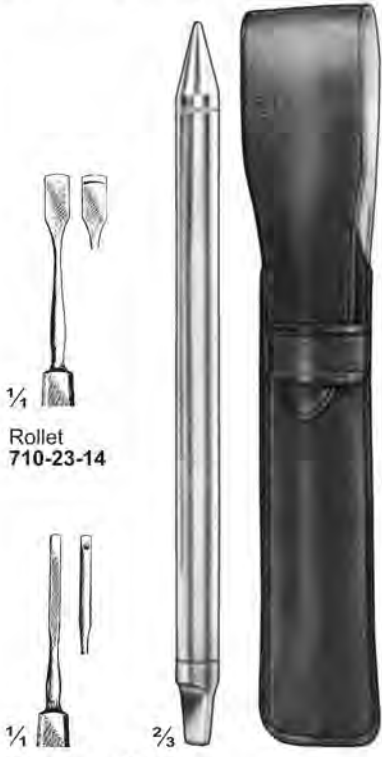

Rollet  
710-23-14

Nicati  
710-24-14

710-25-14  
14 cm / 5½"  
Packed in plastic pouch



710-26-04  
Complete set consisting:  
1 Handle and 4 tips packed  
in plastic pouch

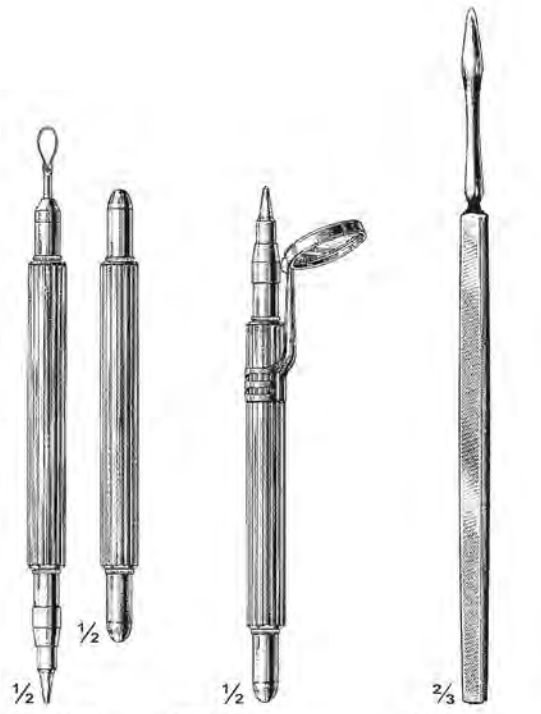

Standard  
710-27-15  
15 cm / 6"

Standard  
710-28-15  
15 cm / 6"  
With magnifying glass

Luer  
710-29-14  
14 cm / 5½"



Ophthalmic Instrumente  
Ophthalmic Instruments  
Instruments Ophthalmiques



Dix  
711-01-15  
15 cm / 6"



Dix  
711-02-15  
15 cm / 6"



Dix  
711-03-15  
15 cm / 6"



Dix  
711-04-15  
15 cm / 6"



711-05-15  
15 cm / 6"



711-06-15  
15 cm / 6"



711-07-13  
13 cm / 5 1/8"



711-08-13  
13 cm / 5 1/8"



711-09-16  
16 cm / 6 1/4"



711-10-16  
16 cm / 6 1/4"



711-11-11  
11 cm / 4 1/4"



Bowman  
711-13-12  
12 cm / 4 3/4"



Bowman  
711-14-12  
12 cm / 4 3/4"



Schweigger  
711-15-12  
12 cm / 4 3/4"

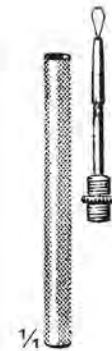

711-12-07  
7 cm / 2 3/4"



Ophthalmic Instruments  
Ophthalmic Instruments  
Instruments Ophthalmiques

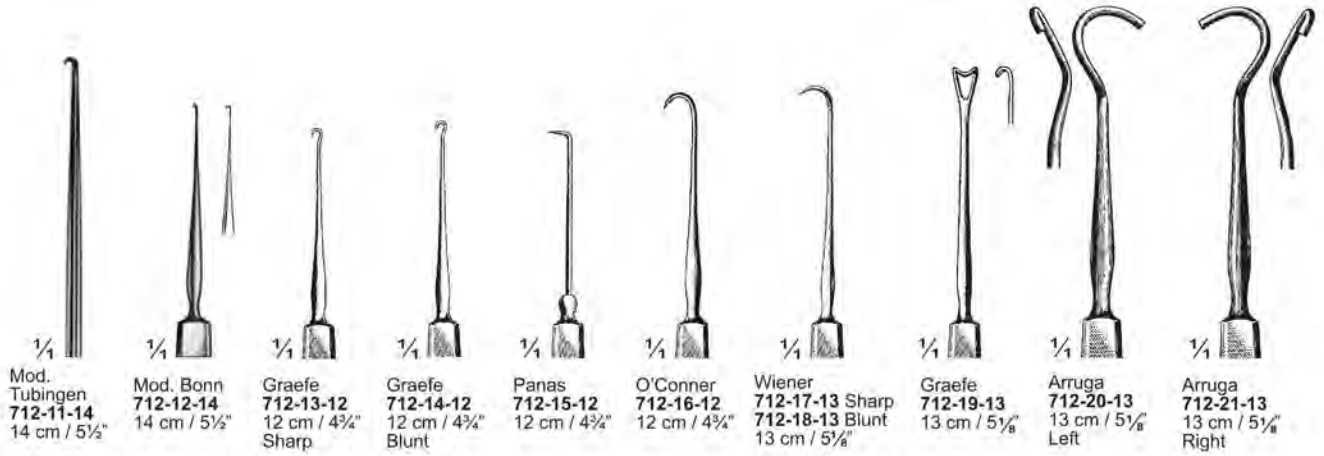

712-01-12 To 712-32-13

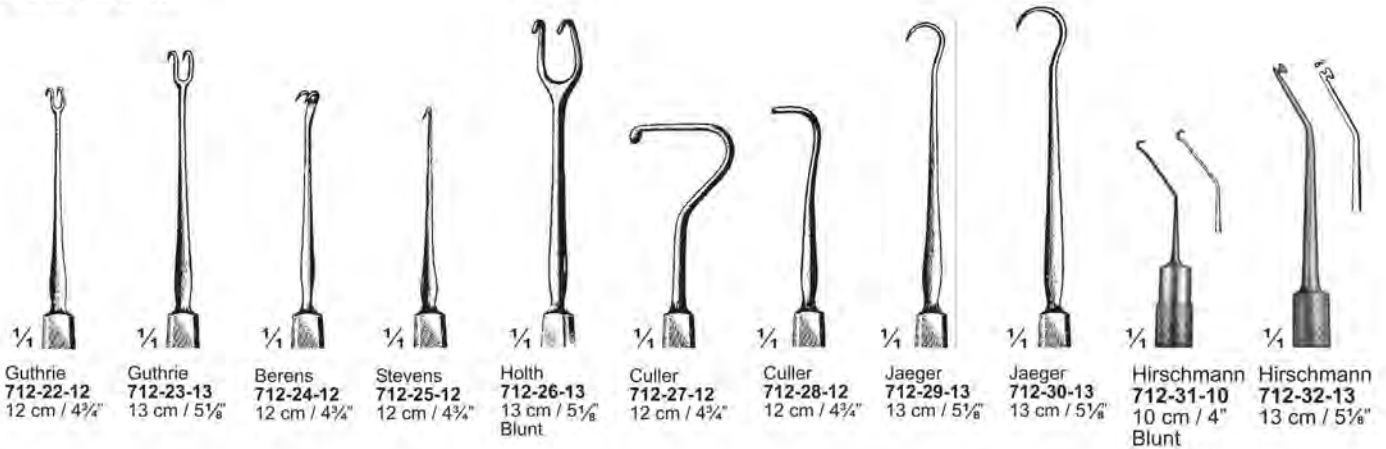

Ophthalmic Instruments  
Ophthalmic Instruments  
Instruments Ophthalmiques

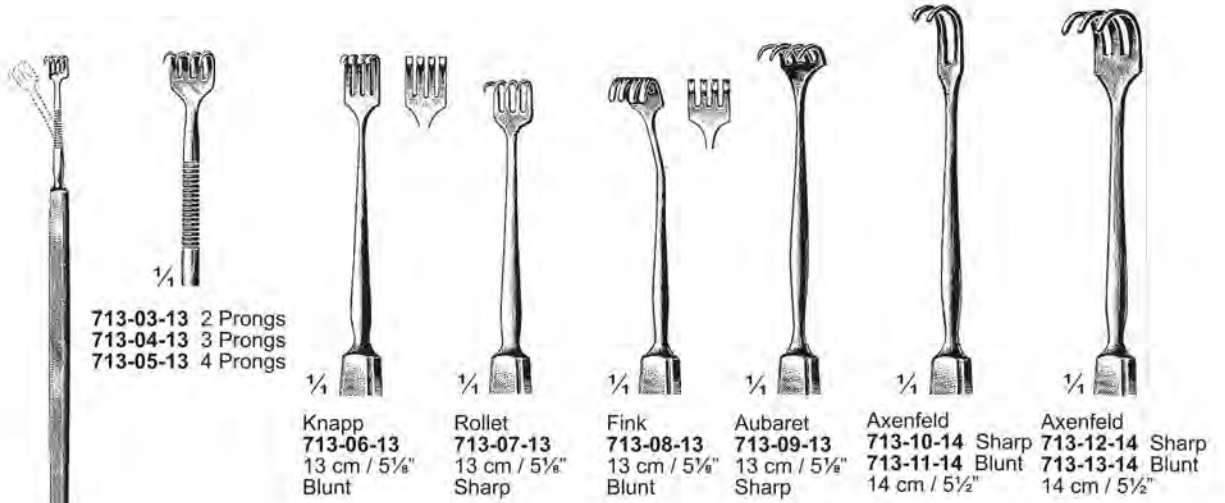

713-03-13 To 713-05-13  
13 cm / 5 1/8"  
Flexible shaft



713-01-10 Left  
713-02-10 Right  
10.5 cm / 4 1/8"

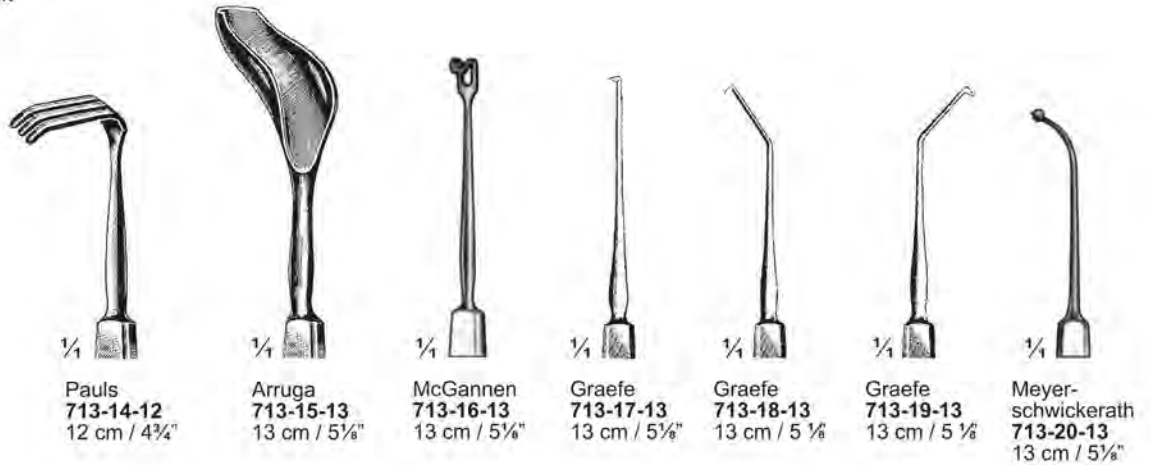

**Ophthalmic Instrumente  
Ophthalmic Instruments  
Instruments Ophthalmiques**



**Ophthalmic Instrumente  
Ophthalmic Instruments  
Instruments Ophthalmiques**

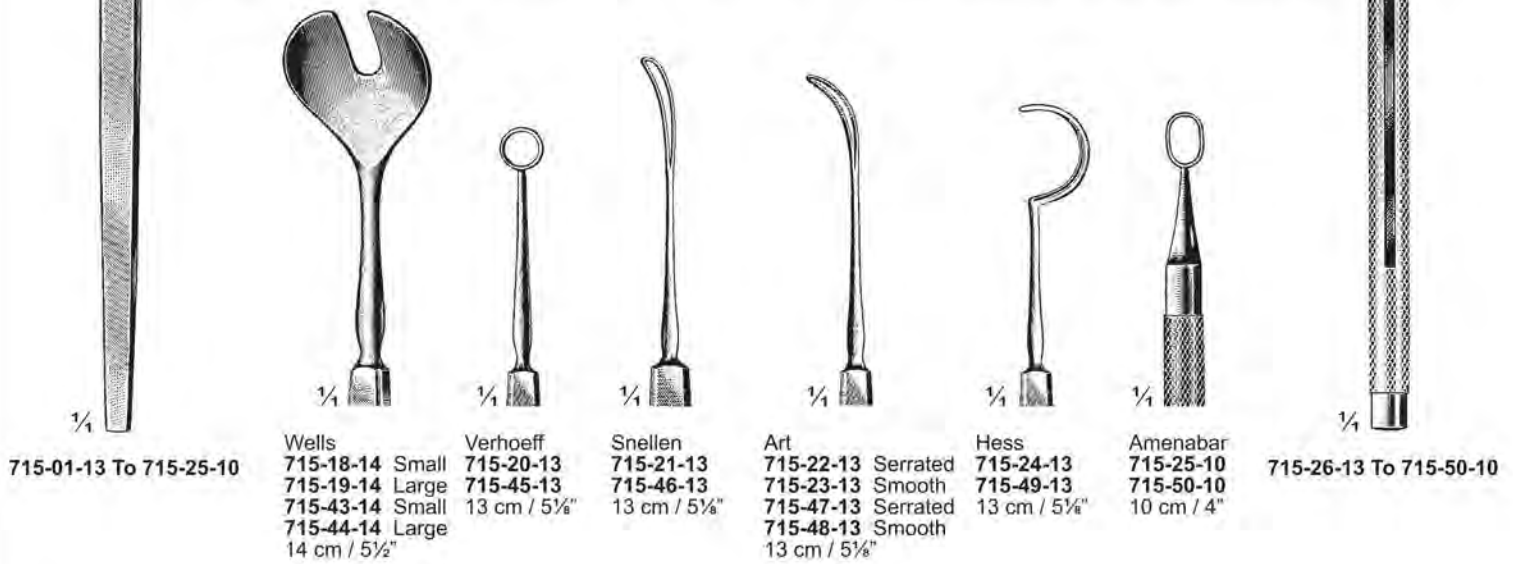
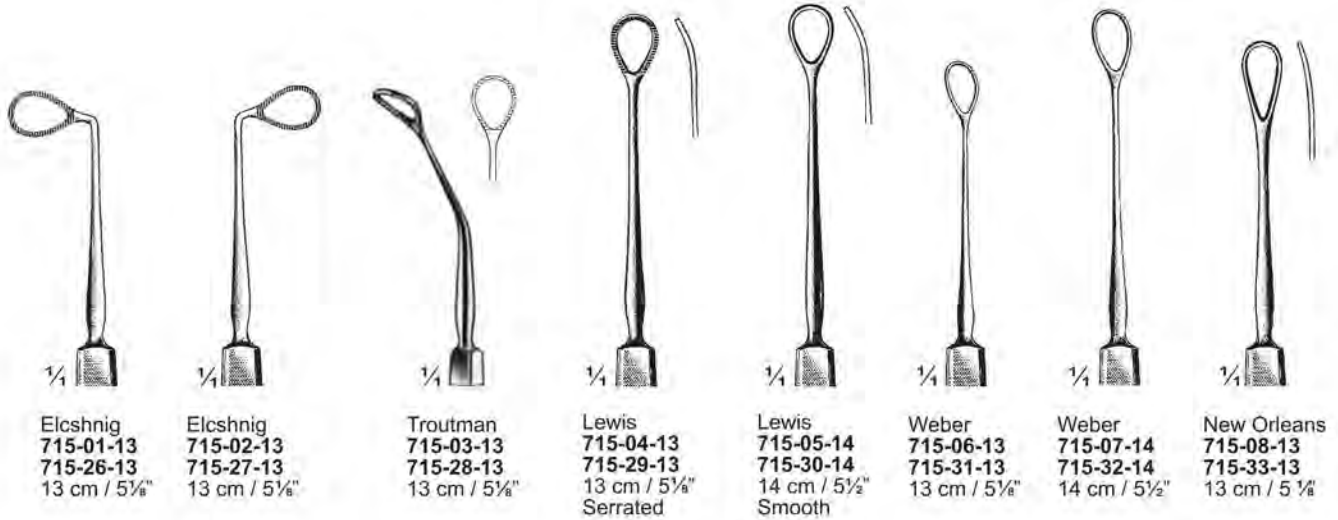

**Ophthalmic Instrumente  
Ophthalmic Instruments  
Instruments Ophthalmiques**

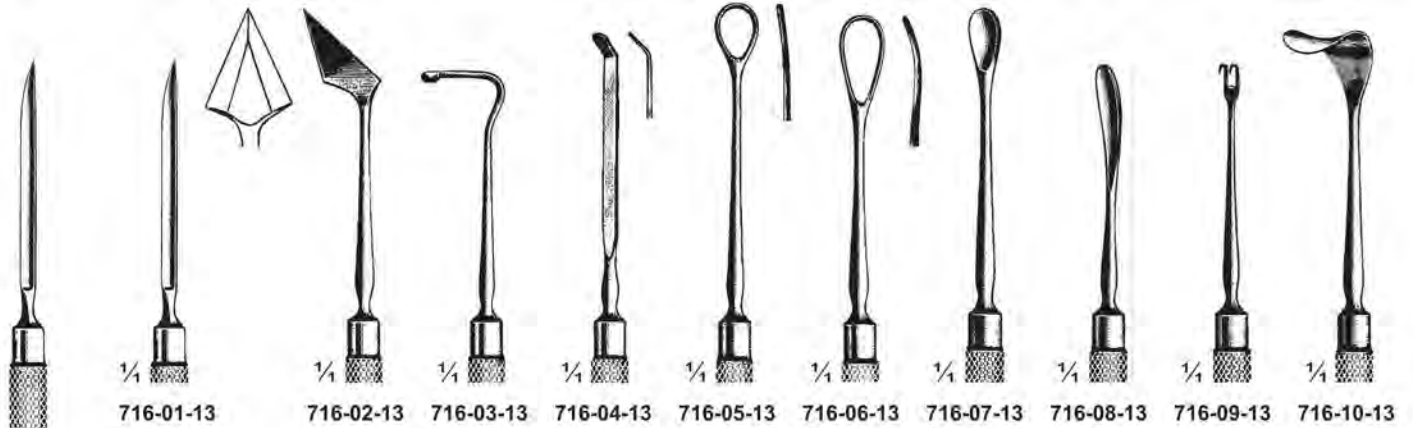

716-01-13
716-02-13
716-03-13
716-04-13
716-05-13
716-06-13
716-07-13
716-08-13
716-09-13
716-10-13

1/4

**Kirby  
716-01-13 To 716-10-13  
13.5 cm / 5 1/4"**

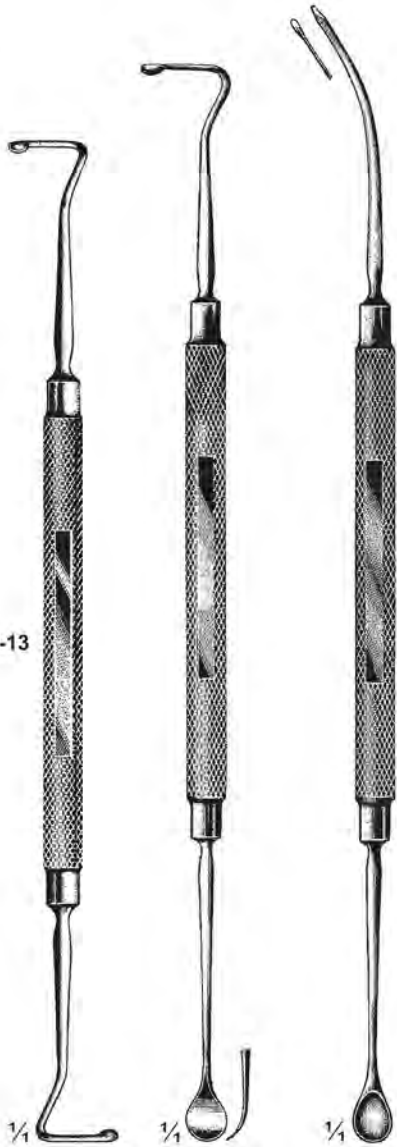

Kirby  
716-11-14  
14 cm / 5 1/2"
Kirby  
716-12-14  
14 cm / 5 1/2"
Kirby  
716-13-15  
15 cm / 6"



**Kirby  
716-14-10  
10 cm / 4"**



**716-15-10 To 716-21-10  
10 cm / 4"**



**Kirby  
716-15-10**

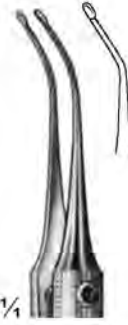

**Kirby  
716-16-10**

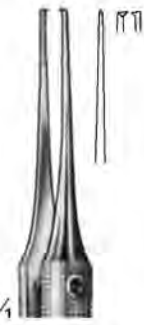

**716-17-10  
1 X 2 Teeth**



**716-18-10  
1 x 2 Teeth  
716-19-10  
2 x 3 Teeth**



**716-20-10  
1 x 2 Teeth**



**716-21-10  
1 x 2 Teeth**

Ophthalmic Instruments  
Ophthalmic Instruments  
Instruments Ophthalmiques



Meyhoefer  
717-01-12 To 717-08-13

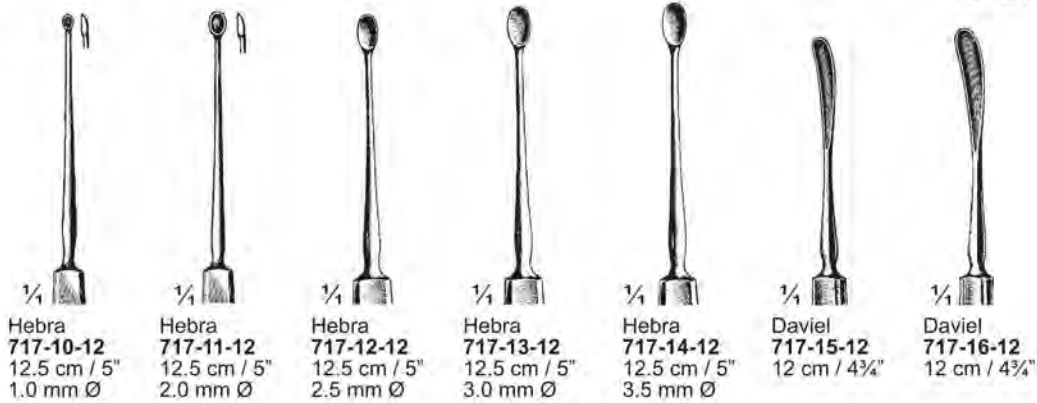
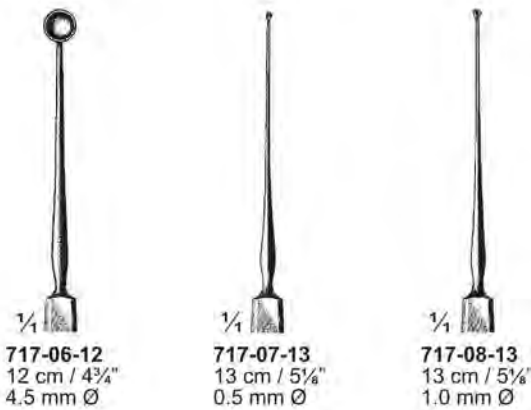
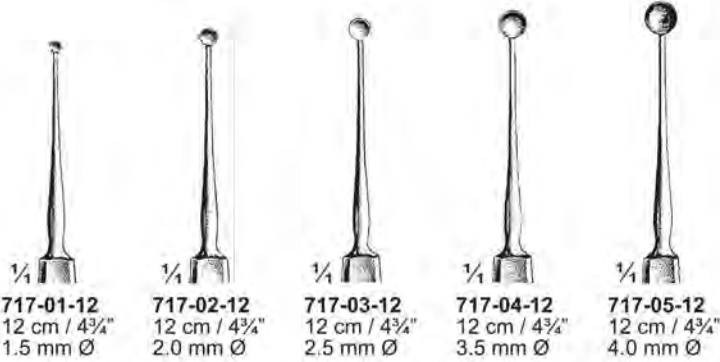

717-10-12 To 717-23-12





**Ophthalmic Instrumente  
Ophthalmic Instruments  
Instruments Ophthalmiques**

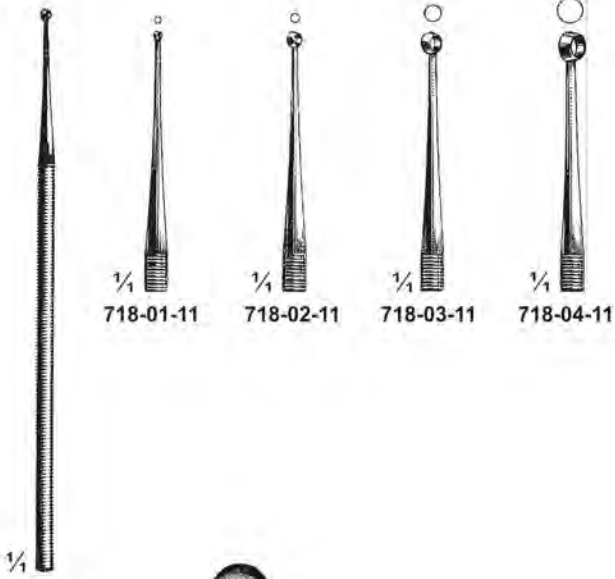

Heath  
718-01-11 To 718-04-11  
11.5 cm / 4½"

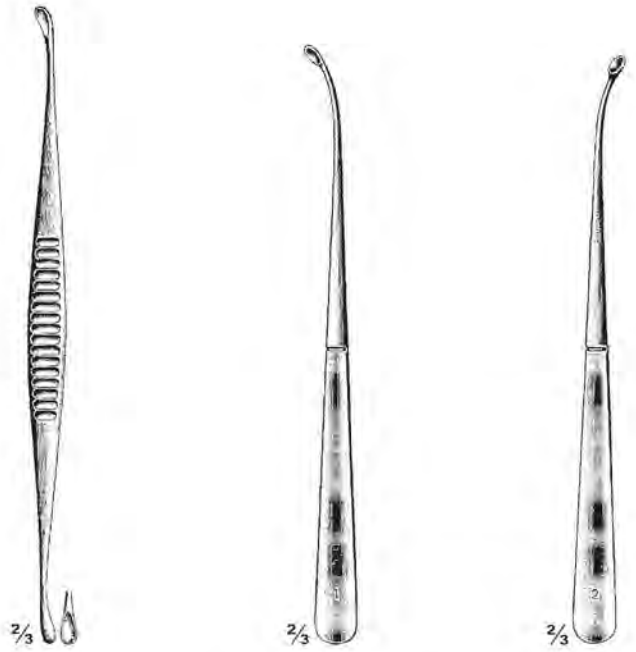

Axenfeld  
718-05-13  
13 cm / 5½"

Axenfeld  
718-06-12  
12 cm / 4¾"

Axenfeld  
718-07-12  
12 cm / 4¾"



Lang  
718-08-13  
13 cm / 5⅛"



Bunge  
718-08-13 to 718-13-14  
14 cm / 5½"

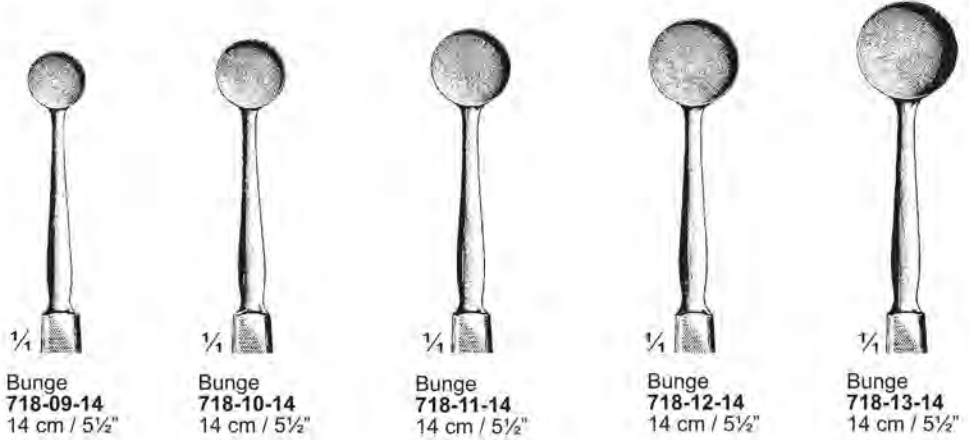

Bunge  
718-09-14  
14 cm / 5½"

Bunge  
718-10-14  
14 cm / 5½"

Bunge  
718-11-14  
14 cm / 5½"

Bunge  
718-12-14  
14 cm / 5½"

Bunge  
718-13-14  
14 cm / 5½"



Ophthalmic Instrumente  
Ophthalmic Instruments  
Instruments Ophthalmiques



$\frac{1}{4}$   
**719-01-14**  
14.5 cm / 5 $\frac{1}{4}$ "



$\frac{1}{4}$   
**Harms 719-02-04**  
4.5 cm / 1 $\frac{3}{4}$ "



$\frac{1}{4}$   
**Harms 719-03-04**  
4.5 cm / 1 $\frac{3}{4}$ "



$\frac{1}{4}$   
**719-04-05**  
5 cm / 2"



$\frac{1}{4}$   
**719-05-05**  
5 cm / 2"



$\frac{1}{4}$   
**719-06-07**  
7.5 cm / 3"



$\frac{1}{4}$   
**719-07-07**  
7.5 cm / 3"



$\frac{1}{4}$   
**Mackensen 719-08-09**  
9 cm / 3 $\frac{1}{2}$ "



$\frac{1}{4}$   
**Mackensen 719-09-09**  
9 cm / 3 $\frac{1}{2}$ "



$\frac{1}{4}$   
**719-10-07 To 719-15-07**  
7 cm / 2 $\frac{3}{4}$ "



$\frac{1}{4}$   
**719-10-07**  
Fig. 00  
0.7 mm Ø



$\frac{1}{4}$   
**719-11-08**  
Fig. 0  
0.8 mm Ø



$\frac{1}{4}$   
**719-12-09**  
Fig. 1  
0.9 mm Ø



$\frac{1}{4}$   
**719-13-01**  
Fig. 2  
1.1 mm Ø



$\frac{1}{4}$   
**719-14-01**  
Fig. 3  
1.3 mm Ø



$\frac{1}{4}$   
**719-15-01**  
Fig. 2  
1.4 mm Ø



$\frac{2}{3}$   
**Ziegler 719-16-11**  
11 cm / 4 $\frac{1}{4}$ "



**Bowmann 719-17-14**  
14 cm / 5 $\frac{1}{2}$ "  
Complete with 5 probes  
and 1 holder



$\frac{2}{3}$   
**Rolf 719-18-15**  
15 cm / 6"



$\frac{1}{4}$   
**719-19-18**  
18 cm / 7"





# Ophthalmic Instruments Ophthalmic Instruments Instruments Ophthalmiques

Stainless	Silver
720-01-000 Fig. 000	720-10-000
720-02-00 Fig. 00	720-11-00
720-03-0 Fig. 0	720-12-0
720-04-01 Fig. 1	720-13-01
720-05-02 Fig. 2	720-14-02
720-06-03 Fig. 3	720-15-03
720-07-04 Fig. 4	720-16-04
720-08-05 Fig. 5	720-17-05
720-09-06 Fig. 6	720-18-06

Stainless	Silver
720-31-00 Fig. 00-0	720-36-00
720-32-01 Fig. 1-2	720-37-01
720-33-03 Fig. 3-4	720-38-03
720-34-05 Fig. 5-6	720-39-05
720-35-07 Fig. 7-8	720-40-07

Stainless	Silver
720-41-00 Fig. 00-00	720-51-00
720-42-0 Fig. 0-0	720-52-0
720-43-01 Fig. 1-1	720-53-01
720-44-02 Fig. 2-2	720-54-02
720-45-03 Fig. 3-3	720-55-03
720-46-04 Fig. 4-4	720-56-04
720-47-05 Fig. 5-5	720-57-05
720-48-06 Fig. 6-6	720-58-06
720-49-07 Fig. 7-7	720-59-07
720-50-08 Fig. 8-8	720-60-08

Stainless	Silver
720-19-0000 Fig. 0000-000	720-25-0000
720-20-00 Fig. 00-1	720-26-00
720-21-01 Fig. 1-2	720-27-01
720-22-03 Fig. 3-4	720-28-03
720-23-05 Fig. 5-6	720-29-05
720-24-07 Fig. 7-8	720-30-07



Galezowsky  
720-01-000 To 720-18-06  
7.5 cm / 3"



Bowmann  
720-19-0000 To 720-30-07  
13 cm / 5 1/8"



Bowmann (Williams)  
720-31-00 To 720-40-07  
13 cm / 5 1/8"



Bowmann  
720-41-00 To 720-60-08  
13 cm / 5 1/8"



1/4  
Galezowsky  
720-61-04  
4 cm / 1 1/2"



Wilder  
720-62-11  
11 cm / 4 1/4"



Wilder  
720-63-11  
11 cm / 4 1/4"



Wilder  
720-64-11  
11 cm / 4 1/4"



Simpson  
720-65-10  
10.5 cm / 4 1/8"



Simpson  
720-66-10  
10.5 cm / 4 1/8"



Ravertino  
720-67-08  
8.5 cm / 3 3/8"



Muldoon  
720-68-10  
10 cm / 4"



Castroviejo  
720-69-12  
12.5 cm / 5"



**Nadeln & Fräser ; Agujas & Trépanos  
Needles & Trephine ; Aghi & Trepani  
Aiguilles & Trépan ; Agulhas & Trépanos**



Ziegler  
721-01-01 To 721-03-05  
14 cm / 5½"

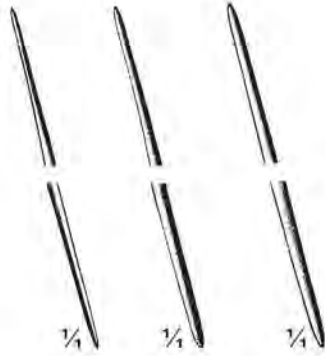

721-01-01 Fig. 1-2  
721-02-03 Fig. 3-4  
721-03-05 Fig. 5-6



2/3  
Paton  
721-04-15  
15 cm / 6"



2/3  
Berens  
721-05-15  
15 cm / 6"



1/4  
1.5 mm Ø



1/4  
2.0 mm Ø



1/4  
Elliot  
721-06-00  
Complete with  
1 Handle  
2 Trephines 1.5 mm Ø  
2 Trephines 2.0 mm Ø



1/4  
Arruga  
721-07-08  
8.5 cm / 3¼"



Castroviejo  
721-08-05 To 721-16-11  
5 cm / 2"



1/4

- 721-08-05 5.0 mm Ø
- 721-09-05 5.5 mm Ø
- 721-10-06 6.0 mm Ø
- 721-11-06 6.5 mm Ø
- 721-12-07 7.0 mm Ø
- 721-13-08 8.0 mm Ø
- 721-14-09 9.0 mm Ø
- 721-15-10 10.0 mm Ø
- 721-16-11 11.0 mm Ø



1/4



1/4



1/4



1/4



1/4



1/4

- |                     |                    |                    |                   |                   |
|---------------------|--------------------|--------------------|-------------------|-------------------|
| Stephenson          | Elliot             | Grieshaber         | Arruga            | Arruga            |
| 721-17-01 1.0 mm Ø  | 721-23-01 1.0 mm Ø | 721-26-01 1.0 mm Ø | 721-31-06 6 mm Ø  | 721-36-06 6 mm Ø  |
| 721-18-01 1.5 mm Ø  | 721-24-01 1.5 mm Ø | 721-27-01 1.5 mm Ø | 721-32-07 7 mm Ø  | 721-37-07 7 mm Ø  |
| 721-19-01 1.75 mm Ø | 721-25-02 2.0 mm Ø | 721-28-02 2.0 mm Ø | 721-33-08 8 mm Ø  | 721-38-08 8 mm Ø  |
| 721-20-02 2.0 mm Ø  | 5 cm / 2"          | 721-29-02 2.5 mm Ø | 721-34-09 9 mm Ø  | 721-39-09 9 mm Ø  |
| 721-21-02 2.5 mm Ø  |                    | 721-30-03 3.0 mm Ø | 721-35-10 10 mm Ø | 721-40-10 10 mm Ø |
| 721-22-03 3.0 mm Ø  |                    | 6.5 cm / 2½"       | 5 cm / 2"         | 5 cm / 2"         |



**Bohrer Set / Castroviejo ; Set trépano / Castroviejo  
Trepine Set / Castroviejo ; Set trepano / Castroviejo  
Set trépan / Castroviejo ; Set Trefina / Castroviejo**

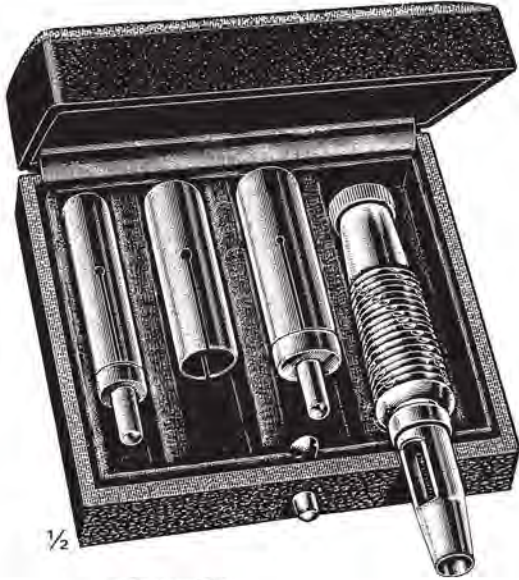

**Castroviejo  
722-01-00**  
Complete consisting :  
1 Castroviejo trephine 4.5 mm Ø  
1 Castroviejo trephine 5.5 mm Ø  
1 Castroviejo trephine 6.5 mm Ø  
Packed in wooden case



**Castroviejo  
722-02-00**  
Complete consisting :  
1 Castroviejo trephine 5.0 mm Ø  
1 Castroviejo trephine 6.0 mm Ø  
1 Castroviejo trephine 6.5 mm Ø  
Packed in stainless steel case

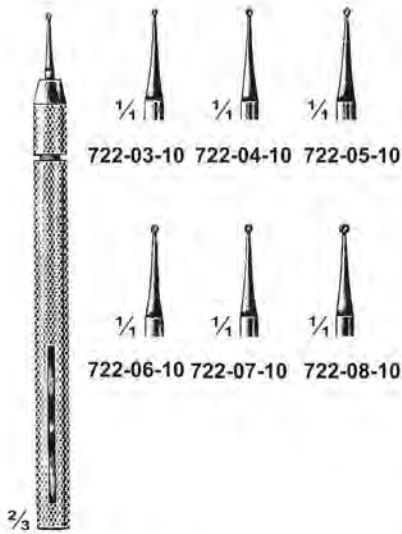

**Storz  
722-03-10 To 722-08-10**  
10.5 cm / 4 1/8"  
722-09-06  
Complete set with  
6 tips

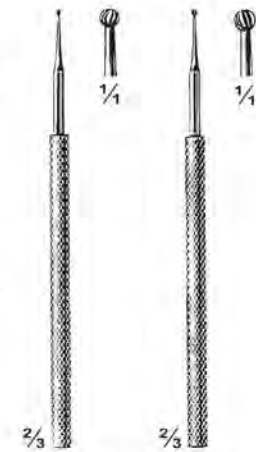

**722-10-09**  
9 cm / 3 1/2"  
**722-11-09**  
9 cm / 3 1/2"



**Holth  
722-12-09**  
9 cm / 3 1/2"



**Lagrange  
722-13-09**  
9 cm / 3 1/2"



**Lagrange  
722-14-12**  
12 cm / 4 3/4"



$\frac{1}{4}$   
 West  
 723-01-16  
 16 cm / 6 $\frac{1}{4}$ "



$\frac{1}{4}$   
 West  
 723-02-16  
 16 cm / 6 $\frac{1}{4}$ "



$\frac{1}{4}$   
 Lueneburg  
 723-03-12  
 12 cm / 4 $\frac{3}{4}$ "



$\frac{1}{4}$   
 Connin-Amsler  
 723-04-13  
 13 cm / 5 $\frac{1}{8}$ "



$\frac{2}{3}$   
 Bishop  
 723-05-12  
 12 cm / 4 $\frac{3}{4}$ "



$\frac{2}{3}$   
 Castroviejo  
 723-06-15  
 Range 15 mm



$\frac{2}{3}$   
 Castroviejo  
 723-07-20  
 Range 20 mm



Castroviejo-Schachar  
 723-08-20  
 Range 20 mm



**Doppelseitige Instrumente ; Instrumentos de doble extremo  
 Double Ended Instruments ; Strumenti a doppio stremo  
 Rugines pour périoste costal ; Instrumentos de duas vezes**

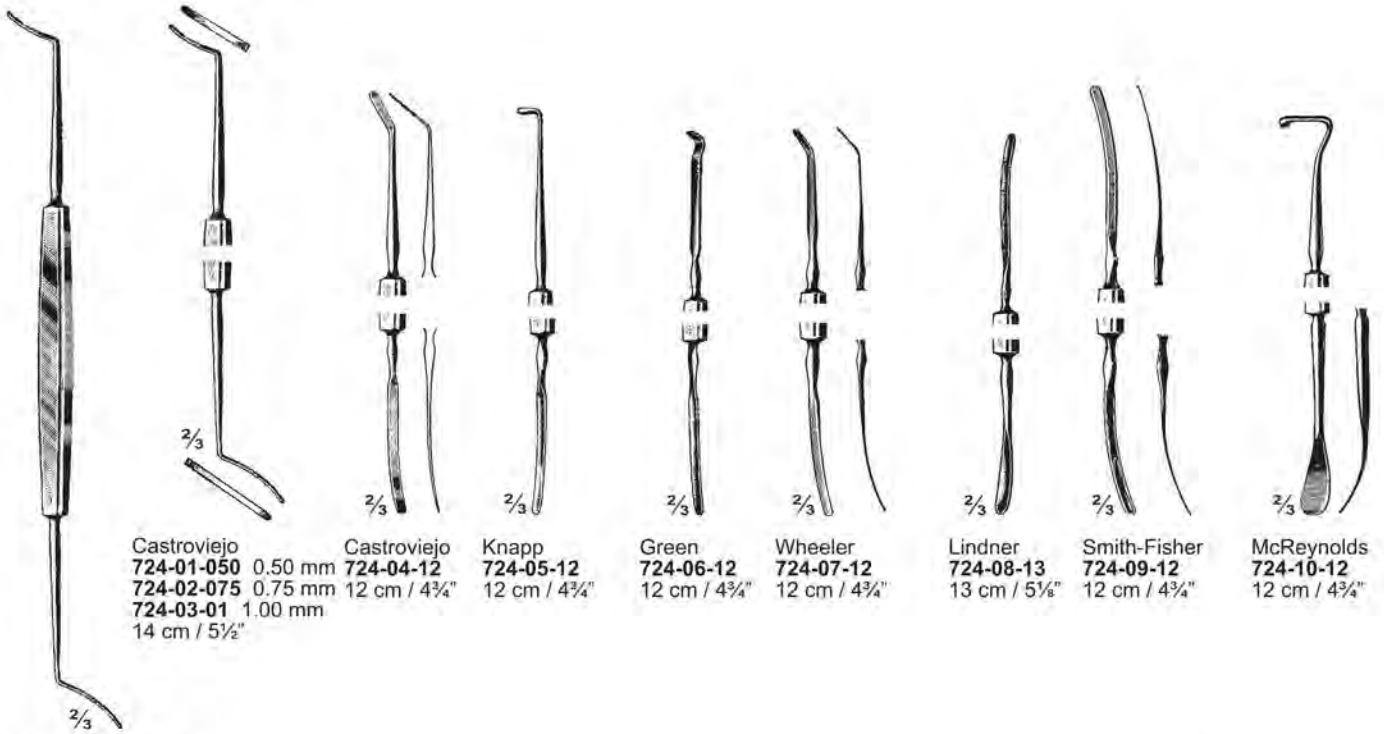

Castroviejo  
 724-01-050 0.50 mm  
 724-02-075 0.75 mm  
 724-03-01 1.00 mm  
 14 cm / 5½"

Castroviejo  
 724-04-12  
 12 cm / 4¾"

Knapp  
 724-05-12  
 12 cm / 4¾"

Green  
 724-06-12  
 12 cm / 4¾"

Wheeler  
 724-07-12  
 12 cm / 4¾"

Lindner  
 724-08-13  
 13 cm / 5¼"

Smith-Fisher  
 724-09-12  
 12 cm / 4¾"

McReynolds  
 724-10-12  
 12 cm / 4¾"

724-01-050 To 724-19-14

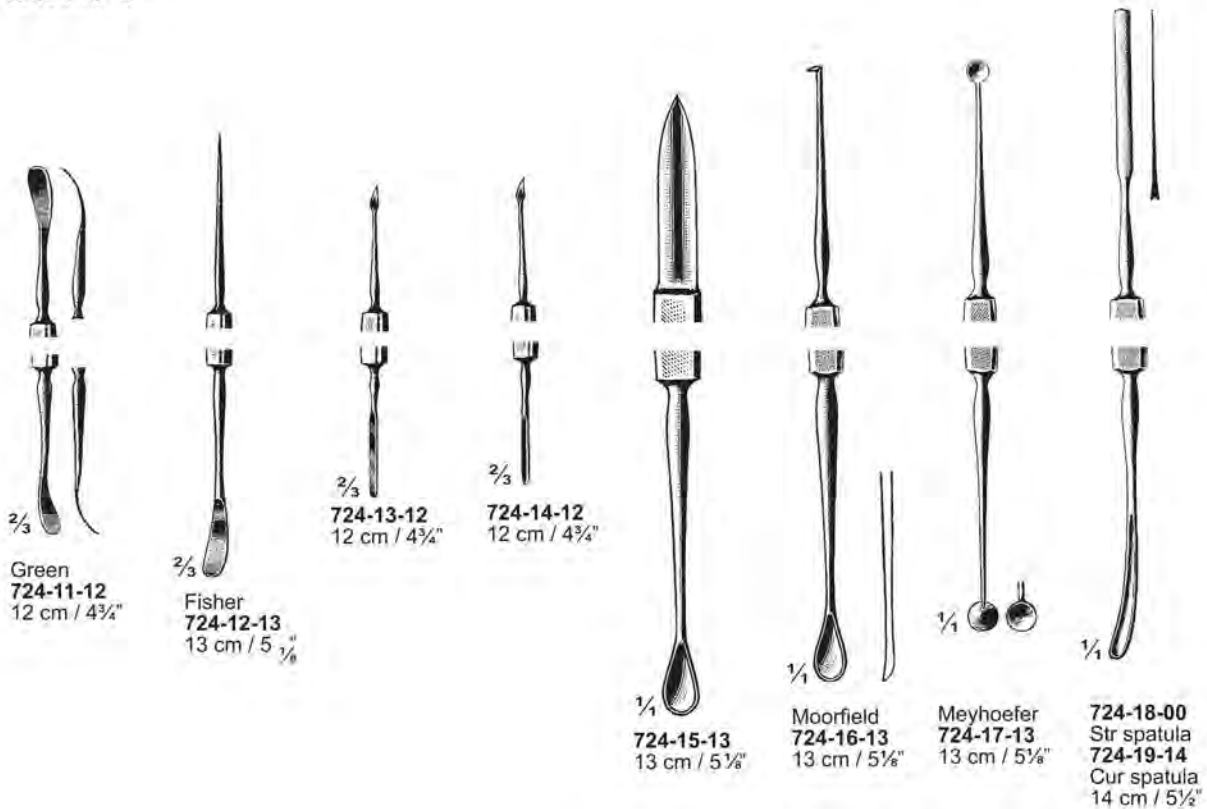

Green  
 724-11-12  
 12 cm / 4¾"

Fisher  
 724-12-13  
 13 cm / 5¼"

724-13-12  
 12 cm / 4¾"

724-14-12  
 12 cm / 4¾"

724-15-13  
 13 cm / 5¼"

Moorfield  
 724-16-13  
 13 cm / 5¼"

Meyhoefer  
 724-17-13  
 13 cm / 5¼"

724-18-00  
 Str spatula  
 724-19-14  
 Cur spatula  
 14 cm / 5½"



**Ophthalmologische Pinzetten ; Pinzas para oftalmología  
Ophthalmology Forceps ; Pinze per oftalmologia  
Pincas pour ophthalmologie ; Pinças para oftalmologia**

All items also available in Titanium

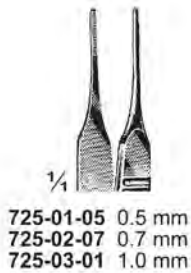

725-01-05 0.5 mm  
725-02-07 0.7 mm  
725-03-01 1.0 mm



725-04-05 0.5 mm  
725-05-07 0.7 mm  
725-06-01 1.0 mm



725-07-05 0.5 mm  
725-08-07 0.7 mm  
725-09-01 1.0 mm  
1 X 2 Teeth



725-10-05 0.5 mm  
725-11-07 0.7 mm  
725-12-01 1.0 mm  
1 X 2 Teeth

Graefe  
725-01-05 To 725-12-01  
7 cm / 2 3/4"

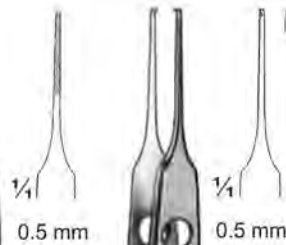

1/4 0.5 mm

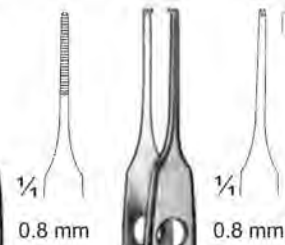

1/4 0.8 mm

Bishop-Harman  
725-13-08  
8.5 cm / 3 1/2"  
Fine points

Bishop-Harman  
725-14-08  
8.5 cm / 3 1/2"  
1 X 2 Teeth  
Fine points

Bishop-Harman  
725-15-08  
8.5 cm / 3 1/2"

Bishop-Harman  
725-16-08  
8.5 cm / 3 1/2"  
1 X 2 Teeth

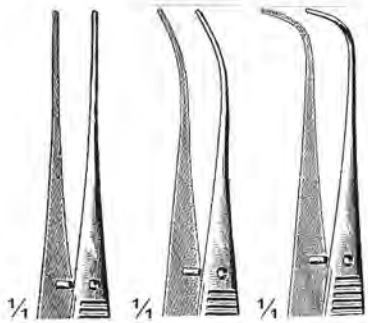

725-17-07 7 cm / 2 3/4"  
725-18-10 10 cm / 4"  
725-19-07 7 cm / 2 3/4"  
725-20-10 10 cm / 4"  
725-21-07 7 cm / 2 3/4"  
725-22-10 10 cm / 4"

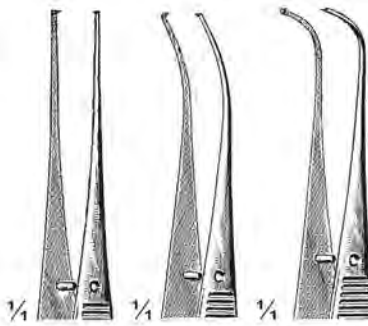

725-23-07 7 cm / 2 3/4"  
725-24-10 10 cm / 4"  
725-25-07 7 cm / 2 3/4"  
725-26-10 10 cm / 4"  
725-27-07 7 cm / 2 3/4"  
725-28-10 10 cm / 4"  
1 X 2 Teeth 1 X 2 Teeth 1 X 2 Teeth

Graefe  
725-17-07 To 725-28-10

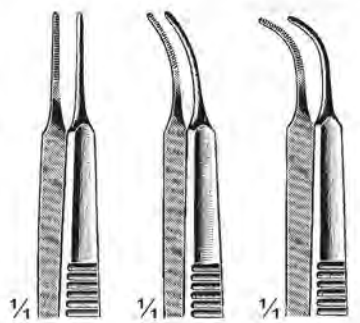

725-29-10 725-30-10 725-31-10

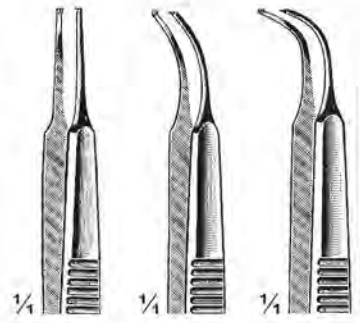

725-32-10 1 X 2 Teeth  
725-33-10 1 X 2 Teeth  
725-34-10 1 X 2 Teeth

Stevens  
725-29-10 To 725-34-10  
10.5 cm / 4 1/2"



725-35-11



725-36-11  
1 X 2 Teeth

Stevens  
725-35-11 To 725-36-11  
11 cm / 4 3/4"

Ophthalmologische Pinzetten ; Pinzas para oftalmología  
 Ophthalmology Forceps ; Pinze per oftalmologia  
 Pincas pour ophthalmologie ; Pinças para oftalmologia

All items also available in Titanium



Foerster  
 726-01-08 To 726-04-08  
 8.5 cm / 3 1/2"



726-01-08



726-02-08

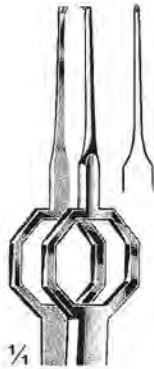

726-03-08  
 1 X 2 Teeth



726-04-08  
 1 X 2 Teeth



Hess  
 726-05-07  
 7 cm / 2 3/4"  
 1 X 2 Teeth

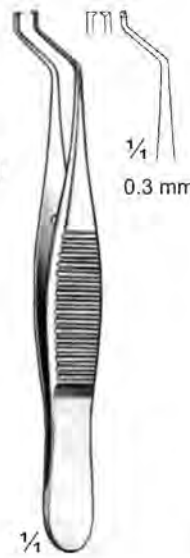

Hess  
 726-06-07  
 7 cm / 2 3/4"  
 1 X 2 Teeth

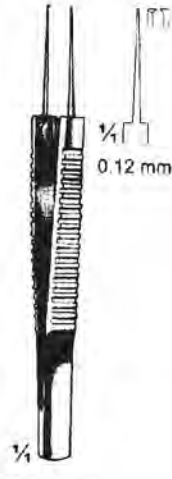

Mod. Bonn  
 726-07  
 7 cm / 2 3/4"  
 1 X 2 Teeth

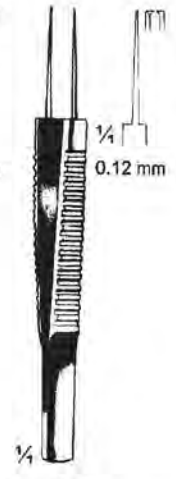

Mod. Bonn  
 726-08  
 7 cm / 2 3/4"  
 1 X 2 Teeth

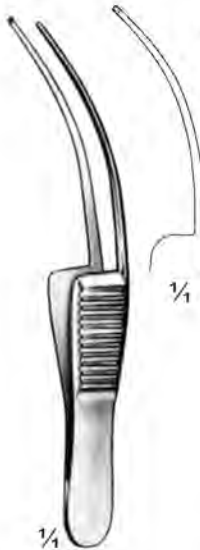

Fischer  
 726-09-07  
 7 cm / 2 3/4"  
 1 X 2 Teeth

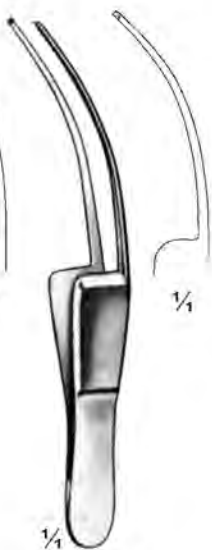

Fischer-Arlt  
 726-10-07  
 7 cm / 2 3/4"  
 1 X 2 Teeth



Panas  
 726-11-08  
 8 cm / 3 1/4"  
 1 X 2 Teeth



Hess  
 726-12-09  
 9 cm / 3 1/2"  
 1 X 2 Teeth



Hess  
 726-13-09  
 9 cm / 3 1/2"  
 1 X 2 Teeth



Elliot  
 726-14-10  
 10 cm / 4"  
 1 X 2 Teeth



O'Connor  
 726-15-10  
 10 cm / 4"  
 1 X 2 Teeth



**Ophthalmologische Pinzetten ; Pinzas para oftalmología  
Ophthalmology Forceps ; Pinze per oftalmologia  
Pincas pour ophthalmologie ; Pinças para oftalmologia**



**Mod. Bonn  
727-01-10**  
10 cm / 4"  
1 X 2 Teeth

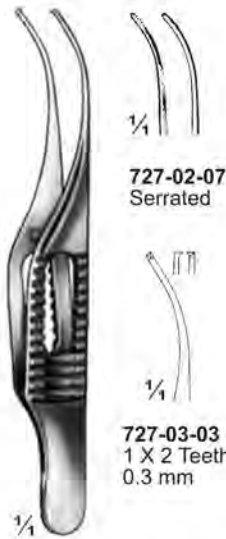

**Gill  
727-02-07 To 727-03-03**  
7.5 cm / 3"

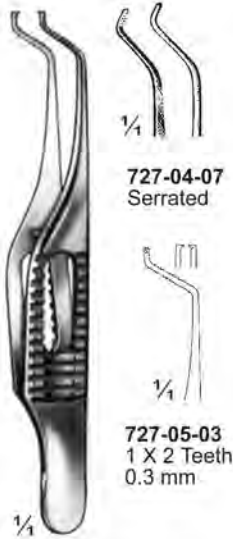

**Gill-Hess  
727-04-07 To 727-05-03**  
7.5 cm / 3"

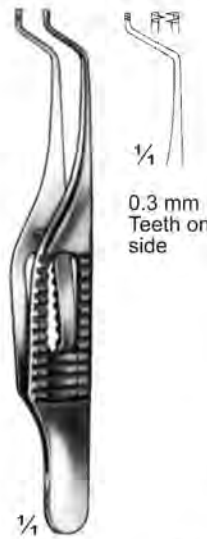

**Gill-Hess  
727-06-07**  
7.5 cm / 3"  
1 X 2 Teeth



**Chandler  
727-07-07 To 727-08-07**  
7 cm / 2 3/4"



**Fuchs  
727-09-07**  
7 cm / 2 3/4"  
1 X 2 Teeth



**727-10-04 To 727-14-12**  
7 cm / 2 3/4"

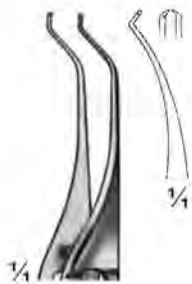

**Barraquer-Katzin  
727-10-04**  
1 X 2 Teeth  
0.4 mm



**Troutman (Colibri)  
727-11-12**  
1 X 2 Teeth  
0.12 mm



**Barraquer (Colibri)  
727-12-12**  
1 X 2 Teeth  
0.12 mm



**Barraquer-Katzin  
(Colibri)  
727-13-12**  
1 X 2 Teeth  
0.12 mm



**Barraquer (Colibri)  
727-14-12**  
1 X 2 Teeth  
0.12 mm



**Castroviejo  
727-15-01 To 727-18-02**  
9 cm / 3 1/2"



**727-15**  
1 X 1 Teeth



**727-16**  
1 X 1 Teeth



**727-17**  
2 X 2 Teeth



**727-18**  
2 X 2 Teeth



**Ophthalmologische Pinzetten ; Pinzas para oftalmología  
Ophthalmology Forceps ; Pinze per oftalmologia  
Pincas pour ophthalmologie ; Pinças para oftalmologia**



Pierse  
728-01-03 To 728-02-03  
8 cm / 3 1/8"  
0.3 mm



Pierse-Colibri  
728-03-07  
7.5 cm / 3"  
0.3 mm



Maumenee-Colibri  
728-04-10  
10 cm / 4"  
1 X 2 Teeth



Elschnig  
728-05-11  
11 cm / 4 1/4"  
1 X 2 Teeth



Elschnig  
728-06-11  
11 cm / 4 1/4"  
1 X 2 Teeth



Sauer  
728-07-03 To 728-08-03  
7.5 cm / 3"  
1 X 2 Teeth

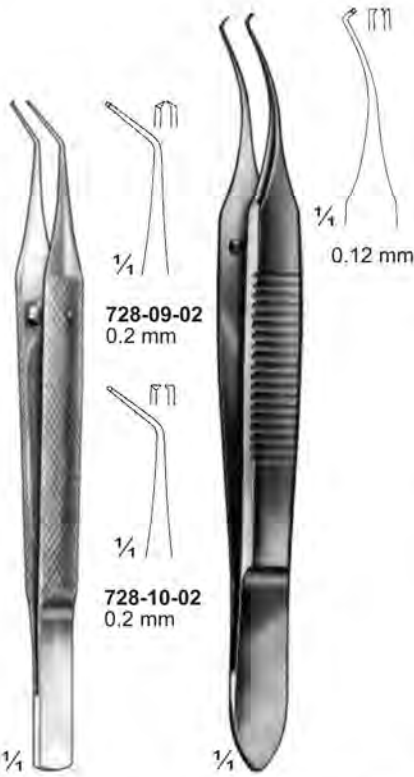

Kirby-Artur  
728-09-02 To 728-10-02  
9 cm / 3 1/2"  
1 X 2 Teeth



Castroviejo-Colibri  
728-11-10  
10 cm / 4"  
1 X 2 Teeth



Barraquer  
728-10-10  
10 cm / 4"



Green  
728-11-05 To 728-14-10  
10 cm / 4"



Barraquer-Llovera  
728-15-09  
9 cm / 3 1/2"



728-16-10  
10 cm / 4"



Graefe  
728-17-11 With lock  
728-18-11 Without lock  
11 cm / 4 1/4"

Ophthalmologische Pinzetten ; Pinzas para oftalmología  
 Ophthalmology Forceps ; Pinze per oftalmologia  
 Pinces pour ophthalmologie ; Pinças para oftalmologia



Clark-Verhoeff  
729-01-11  
11 cm / 4 1/4"

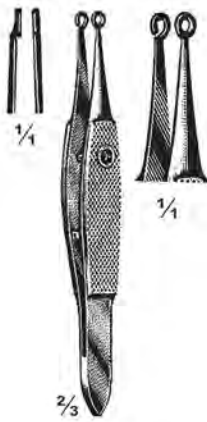

Verhoeff  
729-02-08  
8 cm / 3 1/8"



Willard-Colibri  
729-03-13  
13 cm / 5 1/8"



O'Brein  
729-04-11  
11 cm / 4 1/4"

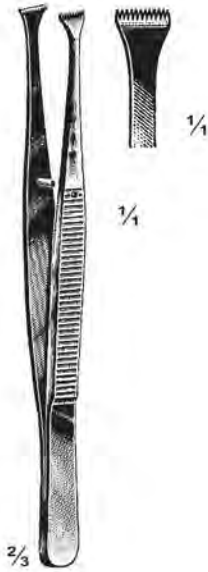

Waldau  
729-05-11  
11 cm / 4 1/4"



Gill-Fuchs  
729-06-07  
7.5 cm / 3"



Gill-Arruga  
729-07-07  
7.5 cm / 3"



Stock  
729-08-09  
9.5 cm / 3 3/4"



Swiss Mod.  
729-09-09  
9.5 cm / 3 3/4"

729-10-09 To 729-13-10



1/4



1/4  
Terson  
729-10-09  
9 cm / 3 1/2"



1/4  
Schweigger  
729-11-10  
10 cm / 4"



1/4  
Schweigger  
729-12-10  
10 cm / 4"

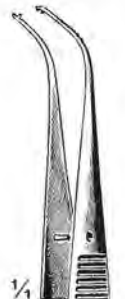

1/4  
Foerster  
729-13-10  
10 cm / 4"

Ophthalmologische Pinzetten ; Pinzas para oftalmología  
 Ophthalmology Forceps ; Pinze per oftalmologia  
 Pinces pour ophthalmologie ; Pinças para oftalmologia



Fuchs  
730-01-07  
7 cm / 2 3/4"



Pley  
730-02-07  
7.5 cm / 3"



730-03-06  
6 cm / 2 1/2"



Hess  
730-04-06  
6 cm / 2 1/2"



Hess  
730-05-07  
7 cm / 2 3/4"



Kalt  
730-06-10  
10 cm / 4"



Kalt  
730-07  
10 cm / 4"

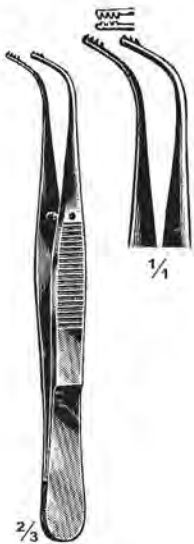

Elschnig  
730-08-10  
10 cm / 4"



Elschnig  
730-09  
10 cm / 4"



Castroviejo  
730-10-10  
10 cm / 4"



Castroviejo  
730-11-10  
10 cm / 4"



Arruga  
730-12-10  
10 cm / 4"



Arruga  
730-13-10  
10 cm / 4"



Arruga-Nizetic  
730-14-10  
10 cm / 4"

Ophthalmic Instruments  
Ophthalmic Instruments  
Instruments Ophthalmiques



Terson  
731-01-09  
9.5 cm / 3¾"



Barraquer  
731-02-10  
10 cm / 4"



Choyce  
731-03-10  
10 cm / 4"



McPherson  
731-04-08  
8.5 cm / 3¼"



McPherson  
731-05-08  
8.5 cm / 3¼"



McPherson  
731-06-08  
8.5 cm / 3¼"  
1 X 2 Teeth



McPherson  
731-07-08  
8.5 cm / 3¼"  
1 X 2 Teeth



Safar  
731-08-07  
7 cm / 2¾"



Green  
731-09-06  
6.5 cm / 2½"



Galín  
731-10-12 To 731-13-40  
12 cm / 4¾"



731-10-12 With irrigator  
731-11-40 40° angled With irrigator  
731-12-12 Without irrigator  
731-13-40 40° angled Without irrigator



Clayman  
731-14-12 With irrigator  
731-15-12 Without irrigator  
12.5 cm / 5"



Shepard  
731-16-12 With irrigator  
731-17-12 Without irrigator  
12.5 cm / 5"

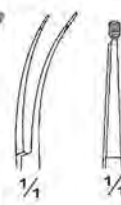

Shepard II  
731-18-12 With irrigator  
731-19-12 Without irrigator  
12.5 cm / 5"





Binkhorst  
732-01-07 With irrigator  
732-02-07 Without irrigator  
7 cm / 2 3/4"



Hirschmann  
732-03-10 With irrigator  
732-04-10 Without irrigator  
10 cm / 4"

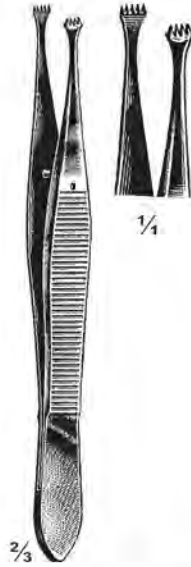

Schmidt-Rimpler  
732-05-11  
11 cm / 4 1/4"  
4 X 5 Teeth



Lester  
732-06-01 To 732-07-02  
9 cm / 3 1/2"



732-06-01  
1 X 2 Teeth

732-07-02  
2 X 3 Teeth



732-07-11  
11 cm / 4 1/4"  
2 X 3 Teeth

732-08-11  
11 cm / 4 1/4"  
3 X 4 Teeth



Falcao  
732-09-10  
10 cm / 4"  
1 X 2 Teeth



Guist  
732-10-10  
10.5 cm / 4 1/8"  
2 X 2 Teeth



Guist  
732-11-10  
10.5 cm / 4 1/8"  
3 X 3 Teeth



Kronfeld  
732-12-08  
8 cm / 3 1/8"



Kronfeld (Panax)  
732-13-08  
8 cm / 3 1/8"



Moorfield  
732-14-10  
10 cm / 4"

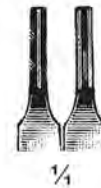

Alabama-  
University  
732-15-09  
9 cm / 3 1/2"

1.5 mm

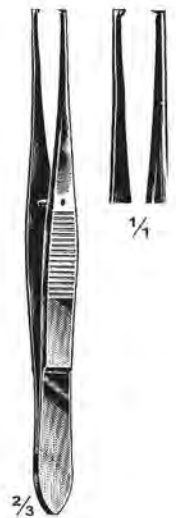

732-16-10  
10 cm / 4"  
1 X 2 Teeth



Dastoor  
733-01-10  
10 cm / 4"  
1 X 2 Teeth

Castroviejo  
733-02-12 To 733-09-01  
10 cm / 4"  
1 X 2 Teeth

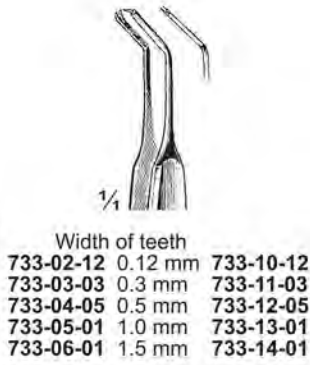

Width of teeth  
733-02-12 0.12 mm 733-10-12  
733-03-03 0.3 mm 733-11-03  
733-04-05 0.5 mm 733-12-05  
733-05-01 1.0 mm 733-13-01  
733-06-01 1.5 mm 733-14-01

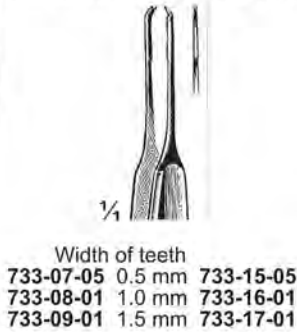

Width of teeth  
733-07-05 0.5 mm 733-15-05  
733-08-01 1.0 mm 733-16-01  
733-09-01 1.5 mm 733-17-01

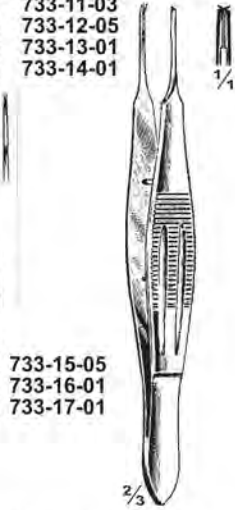

Castroviejo  
733-10-12 To 733-17-01  
10 cm / 4"  
1 X 2 Teeth



733-18-07  
7 cm / 2 3/4"  
1 X 2 Teeth

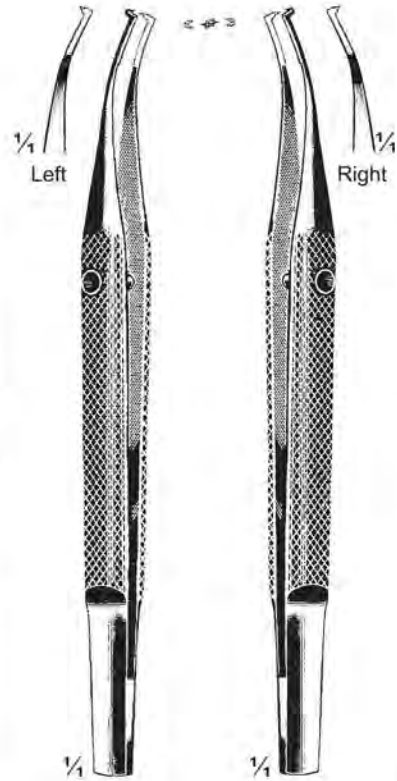

Girad  
733-19-10  
10 cm / 4"  
1 X 2 Teeth

Girad  
733-20-10  
10 cm / 4"  
1 X 2 Teeth



Barraquer Modif.  
733-21-10  
10.5 cm / 4 1/8"



Nugent  
733-22-10 To 733-23-10  
10 cm / 4"



733-22-10

733-23-10



Bonaccollo  
733-24-10 To 733-25-10  
10 cm / 4"



733-24-10

733-25-10



Mod. Tubingen  
733-26-10  
10 cm / 4"



McCullough  
733-27-09 To 733-28-09  
9.5 cm / 3 1/2"



733-27-09

733-28-09  
1 X 2 Teeth



733-29-10 To 733-31-10  
10 cm / 4"

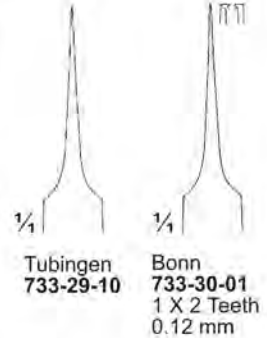

Tubingen  
733-29-10

Bonn  
733-30-01  
1 X 2 Teeth  
0.12 mm

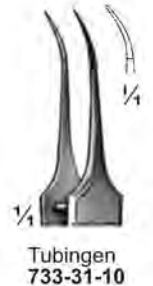

Tubingen  
733-31-10



734-01-11

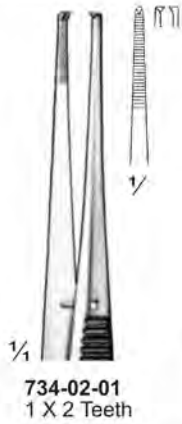

734-02-01  
1 X 2 Teeth

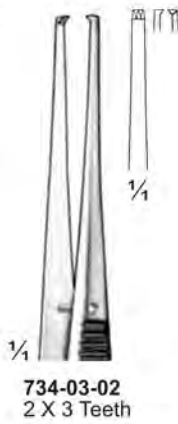

734-03-02  
2 X 3 Teeth



734-04-08  
8.5 cm / 3 1/4"



Paufique  
734-05-10  
10 cm / 4"  
1 X 2 Teeth



McPherson  
734-06-07 To 734-07-10



734-01-11 To 734-03-02  
11 cm / 4 1/4"



Bonaccolto  
734-09-11  
11 cm / 4 1/4"



Dastoor  
734-10-10  
10 cm / 4"  
1 X 2 Teeth



734-11-10  
10 cm / 4"  
1 X 2 Teeth



Troutman-Rectus  
734-12-08  
8.5 cm / 3 1/4"  
1 X 2 Teeth



Jameson  
734-13-10  
10 cm / 4"  
Left



Jameson  
734-14-10  
10 cm / 4"  
Right



Schaaf  
734-08-09  
9 cm / 3 1/2"

Ophthalmic Instrumente  
Ophthalmic Instruments  
Instruments Ophthalmiques

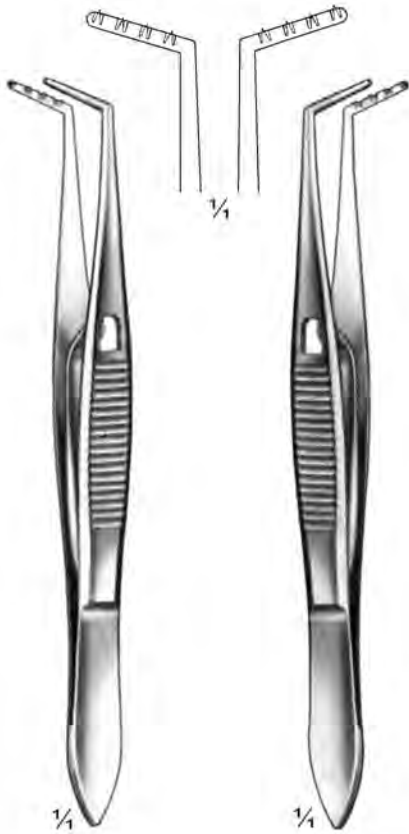

1/4  
Sattler  
735-01-10  
10 cm / 4"

1/4  
Sattler  
735-02-10  
10 cm / 4"

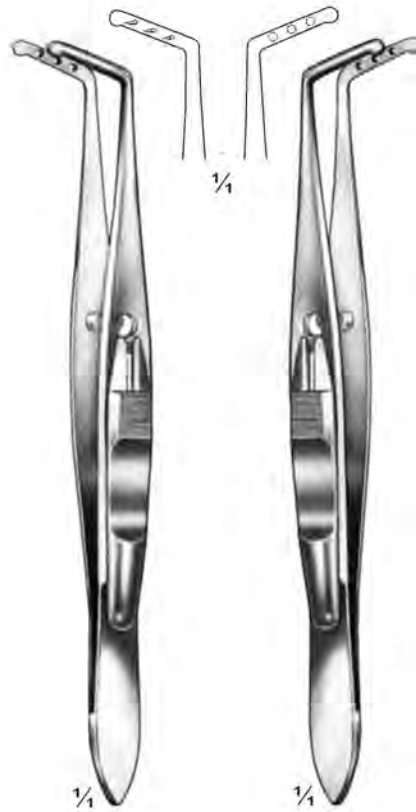

1/4  
Prince  
735-03-10  
10 cm / 4"

1/4  
Prince  
735-04-10  
10 cm / 4"

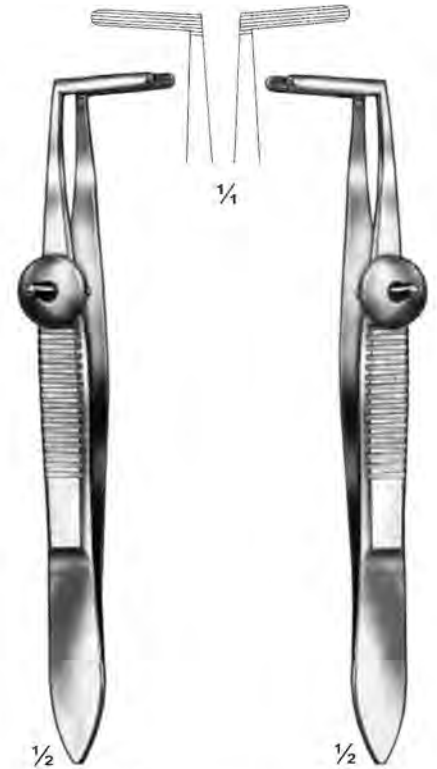

1/2  
Blascovics  
735-05-09  
9 cm / 3 1/2"

1/2  
Blascovics  
735-06-09  
9 cm / 3 1/2"

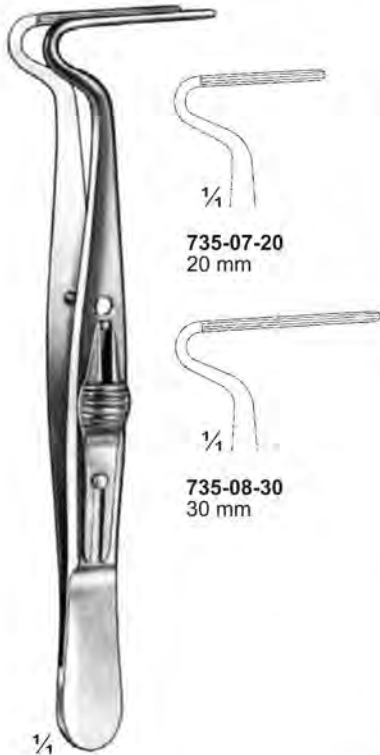

1/4  
735-07-20  
20 mm

1/4  
735-08-30  
30 mm

1/4  
Berke  
735-07-20 To 735-08-30  
10 cm / 4"



1/4  
Fink-Jameson  
735-09-10  
10 cm / 4"

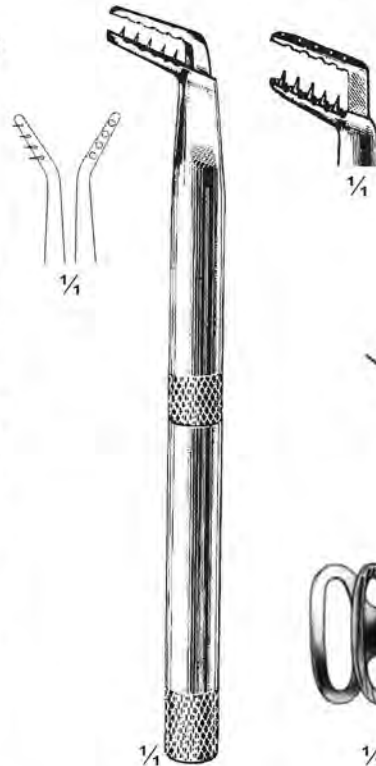

1/4  
Berens  
735-10-10  
10 cm / 4"



1/4

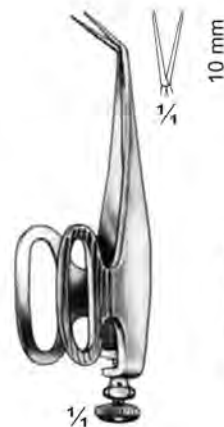

1/4  
Barraquer  
735-11-10  
5.5 cm / 2 1/4"



1/4  
Barraquer  
735-12-07  
5.5 cm / 2 1/4"



1/4  
Barraquer  
735-13-05  
5.5 cm / 2 1/4"



**Ophthalmic Instrumente  
Ophthalmic Instruments  
Instruments Ophthalmiques**



Elschnig  
736-01-11  
11 cm / 4 1/4"

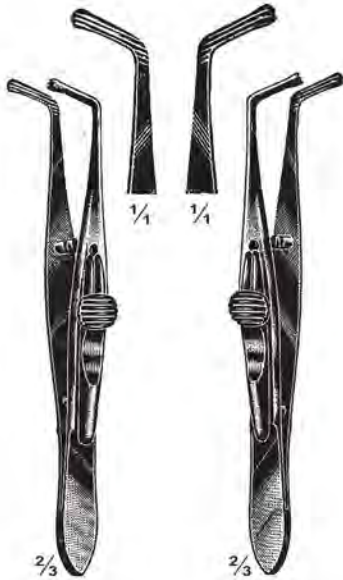

Worth  
736-02-10  
10 cm / 4"

Worth  
736-03-10  
10 cm / 4"



Barens  
736-04-10  
10 cm / 4"



Reese  
736-05-10  
10 cm / 4"

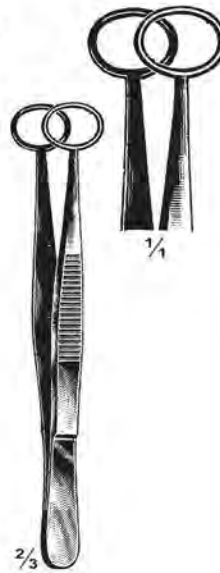

Prince  
736-06-09  
9 cm / 3 1/2"

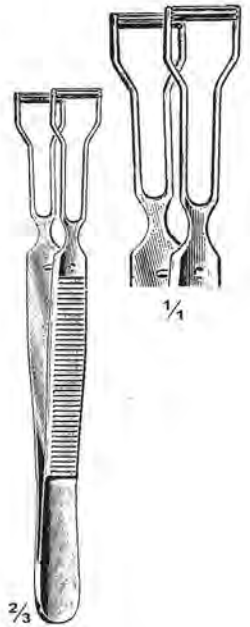

Knapp  
736-07-11  
11 cm / 4 1/4"



Kuhnt  
736-08-09  
9.5 cm / 3 3/4"



Kuhnt  
736-09-09  
9.5 cm / 3 3/4"



736-10-02 To 736-17-04  
8 cm / 3 1/8"

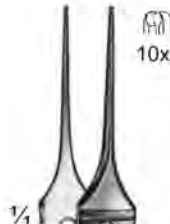

Dermor-Pierse  
736-10-02  
0.2 mm

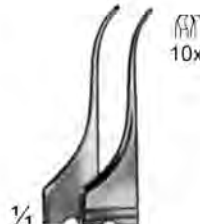

Dermor-Pierse  
736-11-02  
0.2 mm

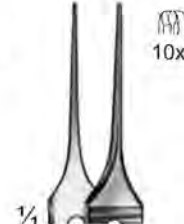

Dermor-Pierse  
736-12-02  
0.2 mm

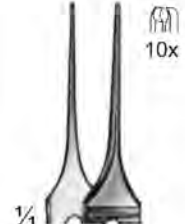

Dermor-Pierse  
736-13-03  
0.3 mm

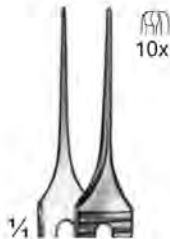

Dermor-Pierse  
736-14-04  
0.4 mm

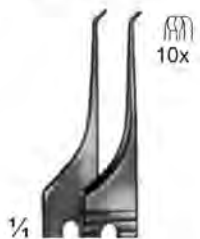

Dermor-Pierse  
(Colibri)  
736-15-02  
0.2 mm



Dermor-Pierse  
(Colibri)  
736-16-03  
0.3 mm



Dermor-Pierse  
(Colibri)  
736-17-04  
0.4 mm

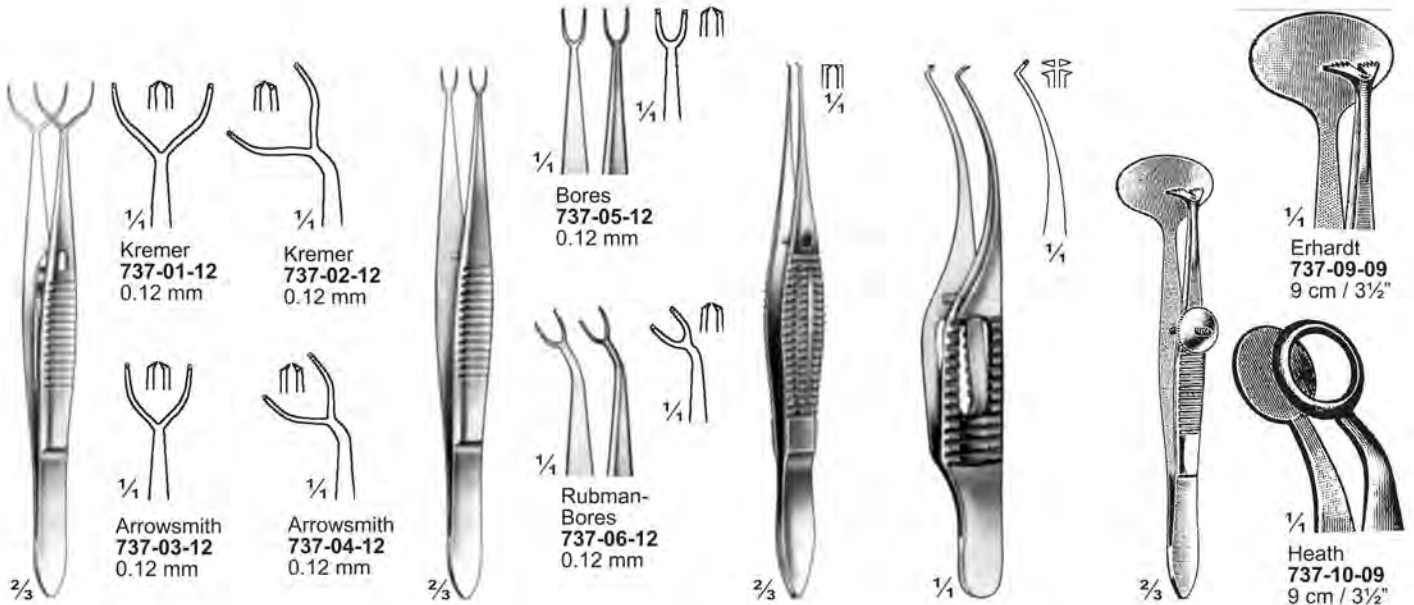

737-01-12 To 737-04-12  
10 cm / 4"

737-05-12 To 737-06-12  
10 cm / 4"

Bores  
737-07-10  
10 cm / 4"

737-08-07  
7 cm / 2 3/4"

737-09-09 To 737-10-09  
9 cm



1/4  
Lambert  
737-11-09  
9 cm / 3 1/2"

1/4  
Lordon  
737-12-09  
9 cm / 3 1/2"



1/4  
Ayer  
737-13-09  
9 cm / 3 1/2"

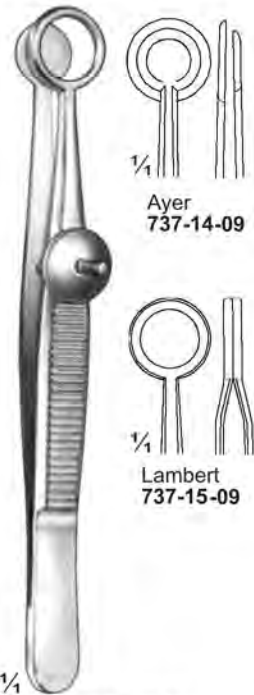

1/4  
737-14-09 To 737-15-09  
9 cm / 3 1/2"

1/4  
Ayer  
737-14-09

1/4  
Lambert  
737-15-09



1/4  
Cauer  
737-10-10  
10 cm / 4"

Ophthalmic Instruments  
Ophthalmic Instruments  
Instruments Ophthalmiques



1/4  
738-01-09



1/4  
738-02-09



1/4  
738-03-09

Desmarres  
738-01-09 To 738-03-09  
9 cm / 3 1/2"



Hunt  
738-04-09  
9.5 cm / 3 3/4"



Spencer  
738-05-10  
10 cm / 4"



Weis  
738-06-10  
10 cm / 4"



Francis  
738-07-09  
9.5 cm / 3 3/4"



Weaver  
738-08-10  
10 cm / 4"



Lordan  
738-09-09  
9.5 cm / 3 3/4"



Carter  
738-10-11  
11 cm / 4 1/4"  
Sphere introducer



Barraquer  
738-11-05 5 mm Blade  
738-12-07 7 mm Blade  
738-13-10 10 mm Blade  
5.5 cm / 2 1/4"



Troutman  
738-14-10  
10 cm / 4"  
Left



Troutman  
738-15-10  
10 cm / 4"  
Right



Troutman-Castroviejo  
738-16-10  
10 cm / 4"

**Ophthalmic Instruments  
Ophthalmic Instruments  
Instruments Ophthalmiques**



**Katzin  
739-01-10  
Left**



**Katzin  
739-02-10  
Right**



**Katzin  
739-03-10  
Left**



**Katzin  
739-04-10  
Right**



**Katzin-Barraquer  
739-05-10  
Left**



**Katzin-Barraquer  
739-06-10  
Right**

**739-01-10 To 739-06-10**  
10 cm / 4"



**Troutman-Barraquer  
739-07-10  
10 cm / 4"  
Left**



**Troutman-Barraquer  
739-08-10  
10 cm / 4"  
Right**



**739-09-10  
10 cm / 4"**



**739-10-10  
10 cm / 4"**



**Castroveijo  
739-11-10  
10 cm / 4"**



**Castroveijo  
739-12-10  
10 cm / 4"**



**Aebli  
739-13-10  
10 cm / 4"**

Ophthalmic Instruments  
Ophthalmic Instruments  
Instruments Ophthalmiques



Troutman-Castroviejo  
740-01-10  
10.5 cm / 4 1/8"



Troutman-Castroviejo  
740-02-10  
10.5 cm / 4 1/8"



Noyes  
740-03-12 To 740-06-12  
12 cm / 4 3/4"



740-03-12  
740-07-12



740-04-12  
740-08-12



740-05-12  
740-09-12

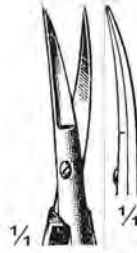

740-06-12  
740-10-12



Noyes  
740-07-12 To 740-10-12  
12 cm / 4 3/4"



Wecker  
740-11-11 To 740-13-11  
11 cm / 4 3/8"



740-11-11



740-12-11



740-13-11



740-14-10



740-15-10



Micro  
740-14-10 & 740-15-10  
10 cm / 4"



McClure  
740-16-10  
10.5 cm / 4 1/8"



McClure  
740-17-10  
10 cm / 4"



McClure  
740-18-09  
9.5 cm / 3 3/4"

**Ophthalmic Instruments  
Ophthalmic Instruments  
Instruments Ophthalmiques**

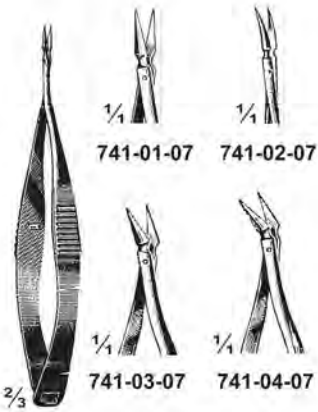

Vannas  
741-01-07 To 741-04-07  
7.5 cm / 3"

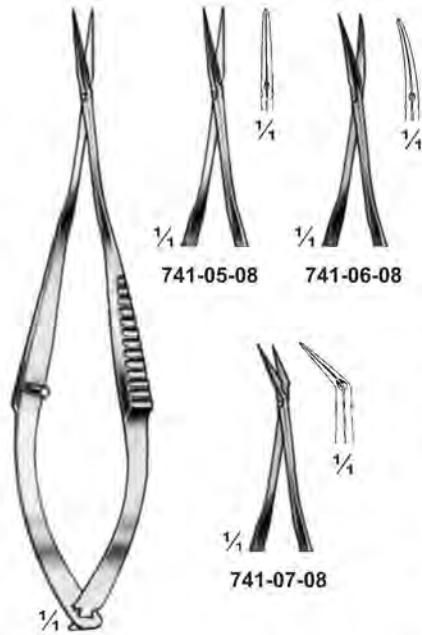

Vannas Mod. Tubingen  
741-05-08 To 741-07-08  
8.5 cm / 3 1/4"

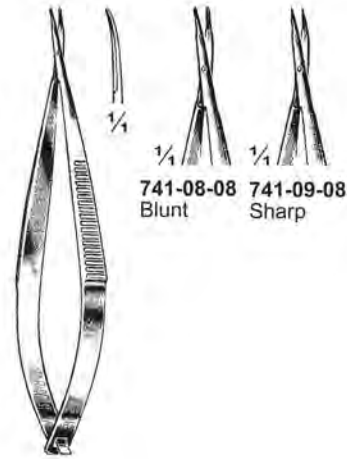

McPherson-Vannas  
741-08-08 To 741-09-08  
8 cm / 3 1/8"

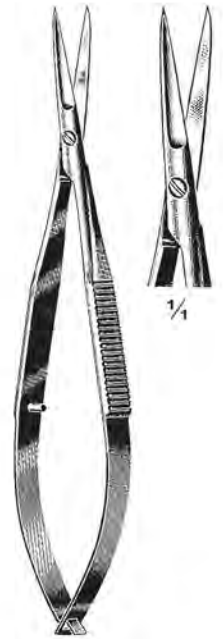

Fine  
741-10-11  
11.5 cm / 4 1/2"



Castroviejo  
741-11-11  
11 cm / 4 1/4"

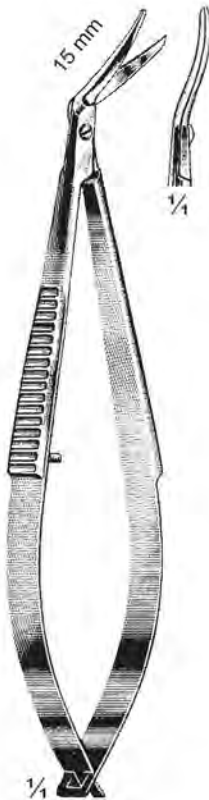

Castroviejo  
741-12-11  
11 cm / 4 1/4"



McPherson-Westcott  
741-13-10  
10 cm / 4"



McPherson-  
Westcott  
741-14-10  
10 cm / 4"



Westcott  
741-15-11  
11 cm / 4 1/4"



Westcott  
741-16-11  
11 cm / 4 1/4"

Ophthalmic Instrumente  
Ophthalmic Instruments  
Instruments Ophthalmiques



Castroviejo  
742-01-11  
11 cm / 4 1/4"

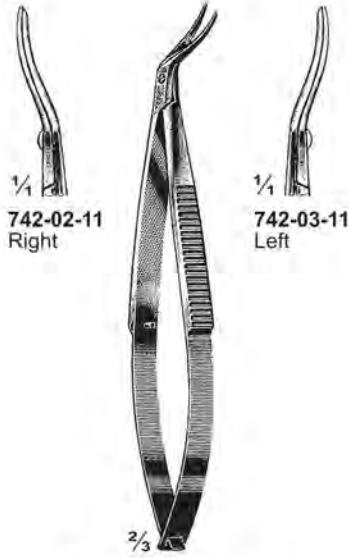

Castroviejo  
742-02-11 & 742-03-11  
11 cm / 4 1/4"

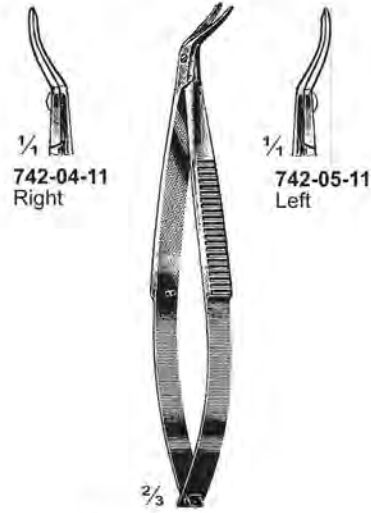

Castroviejo  
742-04-11 & 742-05-11  
11 cm / 4 1/4"



Castroviejo  
742-06-09  
9 cm / 3 1/2"



Scheie-Westcott  
742-07-12  
12 cm / 4 3/4"



742-08-12  
12 cm / 4 3/4"



Castroviejo  
742-09-10 To 742-11-10  
10 cm / 4"

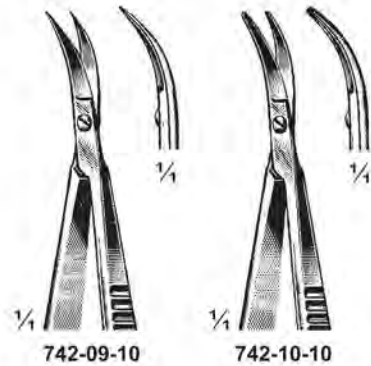

742-09-10

742-10-10



742-11-10



742-12-15  
Sh/Probe



742-13-15  
Sh/Sh



Noyes  
742-12-15 & 742-13-15  
15 cm / 6"

Ophthalmic Instrumente  
 Ophthalmic Instruments  
 Instruments Ophthalmiques



743-01-15  
 15 cm / 6"



LaGrange  
 743-02-10 To 743-03-10  
 10.5 cm / 4 1/8"



1/4  
 743-02-10



1/4  
 743-03-10



1/4  
 743-04-09  
 Left



McGuire  
 743-04-09 To 743-05-09  
 9.5 cm / 3 3/4"



1/4  
 743-05-09  
 Right



743-06-12 To 743-08-12  
 12.5 cm / 5"



743-06-12



743-07-12



743-08-12



Spencer  
 743-09-09  
 9 cm / 3 1/2"



Ophthalmic Instrumente  
 Ophthalmic Instruments  
 Instruments Ophthalmiques



Woodruff  
 744-01-13  
 13 cm / 5 1/8"



Woodruff  
 744-02-13  
 13 cm / 5 1/8"



Da la Roza  
 744-03-12  
 12 cm / 4 3/4"



Da la Roza  
 744-04-12  
 12 cm / 4 3/4"



Hessberg  
 744-05-15  
 15 cm / 6"



Jacobi  
 744-06-14  
 14 cm / 5 1/2"



Mod. Heidelberg  
 744-07-17  
 17.5 cm / 7 1/8"



744-08-18  
 18 cm / 7"  
 1 X 2 Teeth



**745-01-00**

Complete set packed in metal case consisting:

- |   |  |
|---|--|
| 1 Graefe cataract knife                     | 1 Graefe strabismus hook                 |
| 1 Graefe cataract knife                     | 1 Graefe iris hook, sharp                |
| 1 Graefe cataract knife                     | 1 Graefe iris hook, blunt                |
| 1 Beer cataract knife                       | 1 Wecker iris spatula                    |
| 1 Jaeger keratome, str                      | 1 Jaeger lid plate, metal                |
| 1 Jaeger keratome, cur                      | 1 Record syringe 5 ccm                   |
| 1 Desmarres corneal knife                   | 1 Bowman lachrymal probe 00/0            |
| 1 Weber canaliculus knife                   | 1 Bowman lachrymal probe 1/2             |
| 1 Graefe lachrymal sac scarifier            | 1 Bowman lachrymal probe 3/4             |
| 1 Cataract needle, str                      | 1 Wecker sclerotome                      |
| 1 Cataract needle, cur                      | 1 Eye scalpel, bellied                   |
| 1 Bowman discission needle                  | 1 Eye scalpel, pointed                   |
| 1 Desmarres paracentesis needle             | 1 Graefe cataract scoop                  |
| 1 Cystotome                                 | 1 Meyhoefer double ended curette         |
| 1 Graefe eye speculum                       | 1 Weber lens scoop                       |
| 1 Iris scissors, str, 3 1/2"                | 1 Meyer foreign body gouge               |
| 1 Iris scissors, cur, 3 1/2"                | 1 Schweigger discission needle           |
| 1 Iris scissors, angular, 4 1/2"            | 1 Cautery needle                         |
| 1 Tiussue forceps, 4", 1 X 2 teeth, fine    | 1 Desmarres lid retractor, 12 mm wide    |
| 1 Iris forceps, str, 4"                     | 1 Desmarres lid retractor, 14 mm wide    |
| 1 Iris forceps, semi-cur, 4"                | 1 Wecker iris scissors                   |
| 1 Iris forceps, full-cur, 4"                | 1 Graefe strabismus hook                 |
| 1 Graefe fixation forceps with lock, 4 1/2" | 1 Knapp foreign body hook                |
| 1 Beer cilia forceps, 3 1/2"                | 1 Castroviejo needle holder              |
| 1 Desmarres chalazion forceps               | 6 Suture needle in case with sliding lid |
| 1 Jaeger strabismus hook                    | 6 Eye needles                            |



**745-02-00**

Complete set packed in metal case consisting:

- 1 Graefe cataract knife
- 1 Graefe cataract knife
- 1 Graefe cataract knife
- 1 Jaeger keratome, str
- 1 Jaeger keratome, cur
- 1 Weber canaliculus knife
- 1 Bowman discission needle
- 1 Desmarres paracentesis needle
- 1 Foreign body needle
- 1 Cystotome
- 1 Critchett eye speculum
- 1 Iris scissors, cur, 3 1/2"
- 1 Iris scissors, angular, 4 1/2"
- 1 Tiussue forceps, 4", 1 X 2 teeth, fine
- 1 Iris forceps, str, 4"
- 1 Iris forceps, cur, 4"
- 1 Graefe fixation forceps with lock, 4 1/2"
- 1 Beer cilia forceps, 3 1/2"
- 1 Jaeger strabismus hook
- 1 Graefe strabismus hook
- 1 Graefe iris hook, sharp
- 1 Wecker iris spatula
- 1 Bowman lachrymal probe 00/0
- 1 Bowman lachrymal probe 1/2
- 1 Bowman lachrymal probe 3/4



Complete eye sets packed in metal case  
for

- 746-01-00 Iridectomy
- 746-02-00 Entropium
- 746-03-00 Enucleation
- 746-04-00 Evisceration
- 746-05-00 Cataract
- 746-06-00 Chalazion
- 746-07-00 Keratoplasty
- 746-08-00 Pterygium
- 746-09-00 Strabismus
- 746-10-00 Lachrymal Sac

Mikroscheren, Neurochirurgie  
 Micro Neuro Scissors  
 Micro-Ciseaux, Neurochirurgie

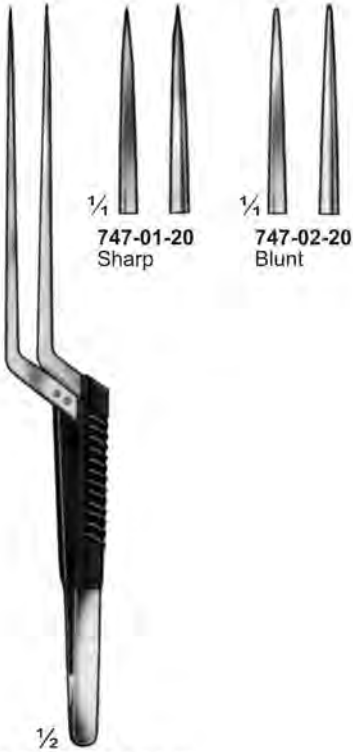

747-01-20 & 747-02-20  
 20 cm / 8"

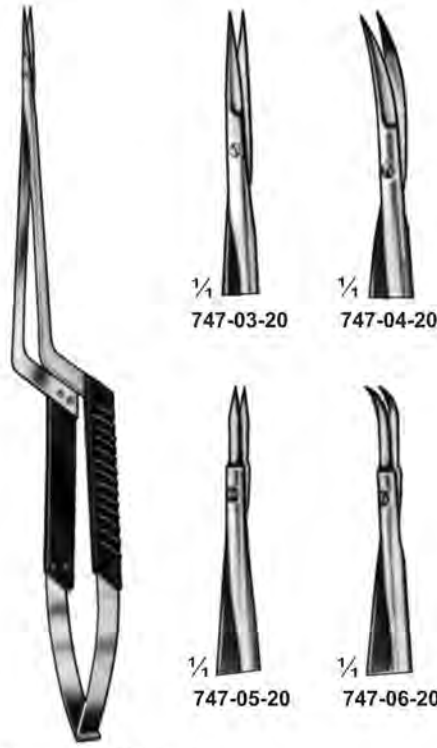

747-03-20 To 747-06-20  
 20 cm / 8"



747-07-20 & 747-08-20  
 20 cm / 8"

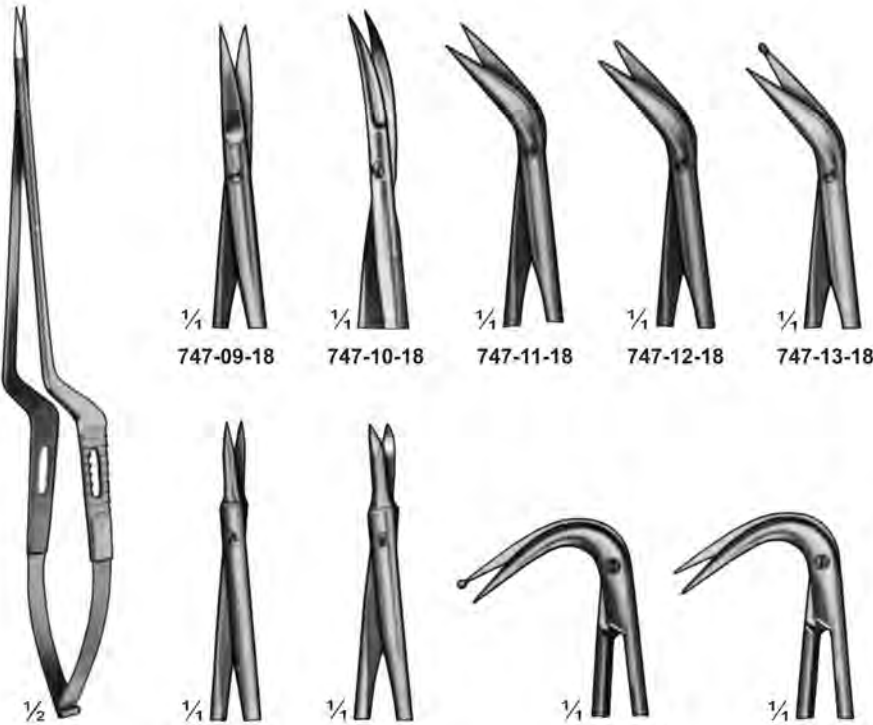

Yasargil  
 747-09-18 To 747-17-124  
 18.5 cm / 7 1/4"

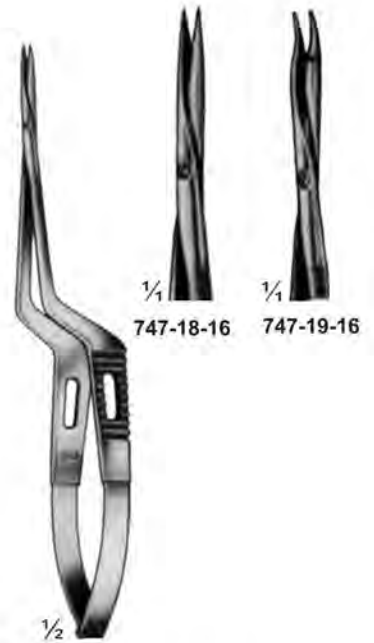

Yasargil  
 747-18-16 & 747-19-16  
 16 cm / 6 1/4"



**Mikro-Nadelhalter, Neurochirurgie**  
**Micro Neuro Scissors, Micro Needle Holder**  
**Micro Porte-aiguilles, Neurochirurgie**



Yasargil  
 748-01-16 To 748-04-16  
 16 cm / 6 1/4"

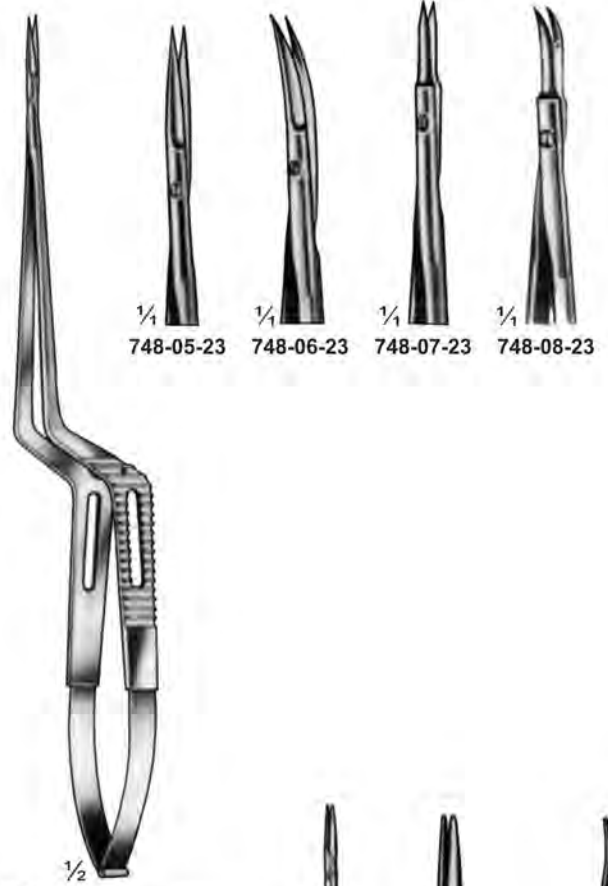

Yasargil  
 748-05-23 To 748-08-23  
 23 cm / 9"



Yasargil  
 748-09-18  
 18.5 cm / 7 1/4"

Yasargil  
 748-10-18  
 18.5 cm / 7 1/4"

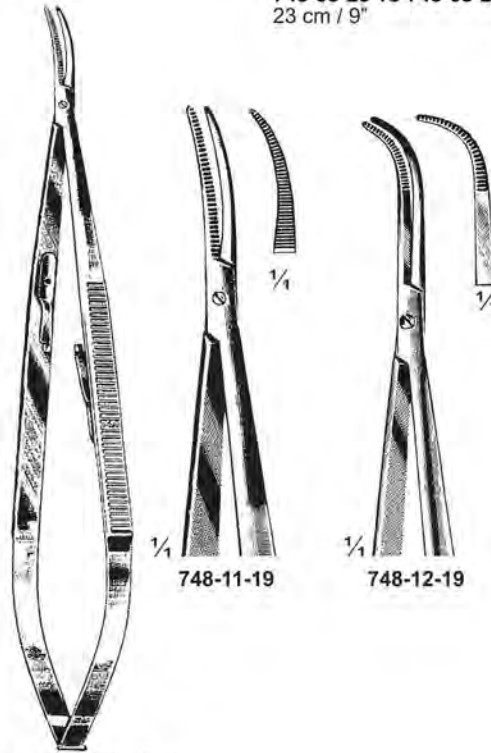

748-11-19 & 748-12-19  
 19.5 cm / 7 1/4"

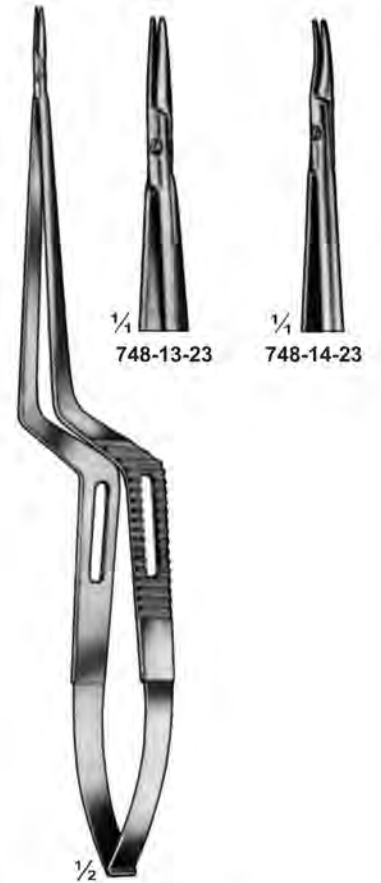

748-13-23 & 748-14-23  
 23 cm / 9"

**Neurochirurgie  
Neurosurgery  
Neurochirurgie**

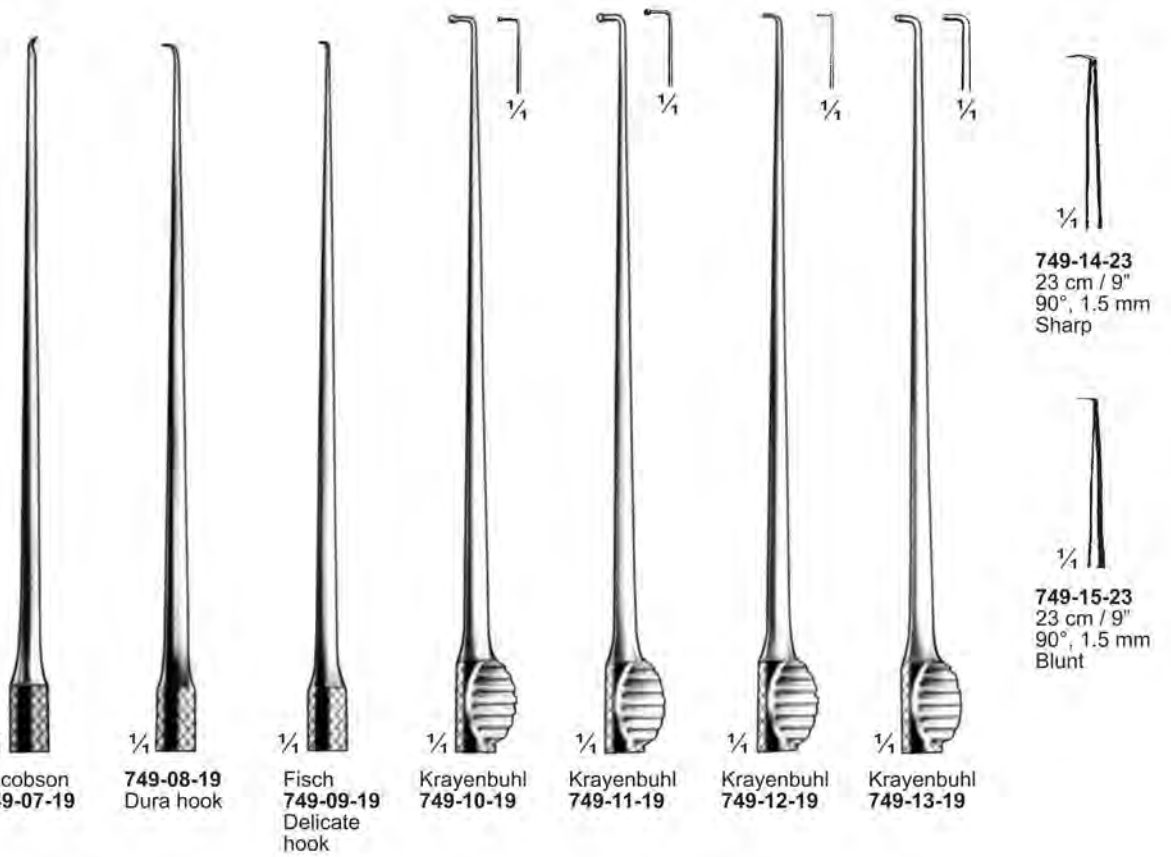
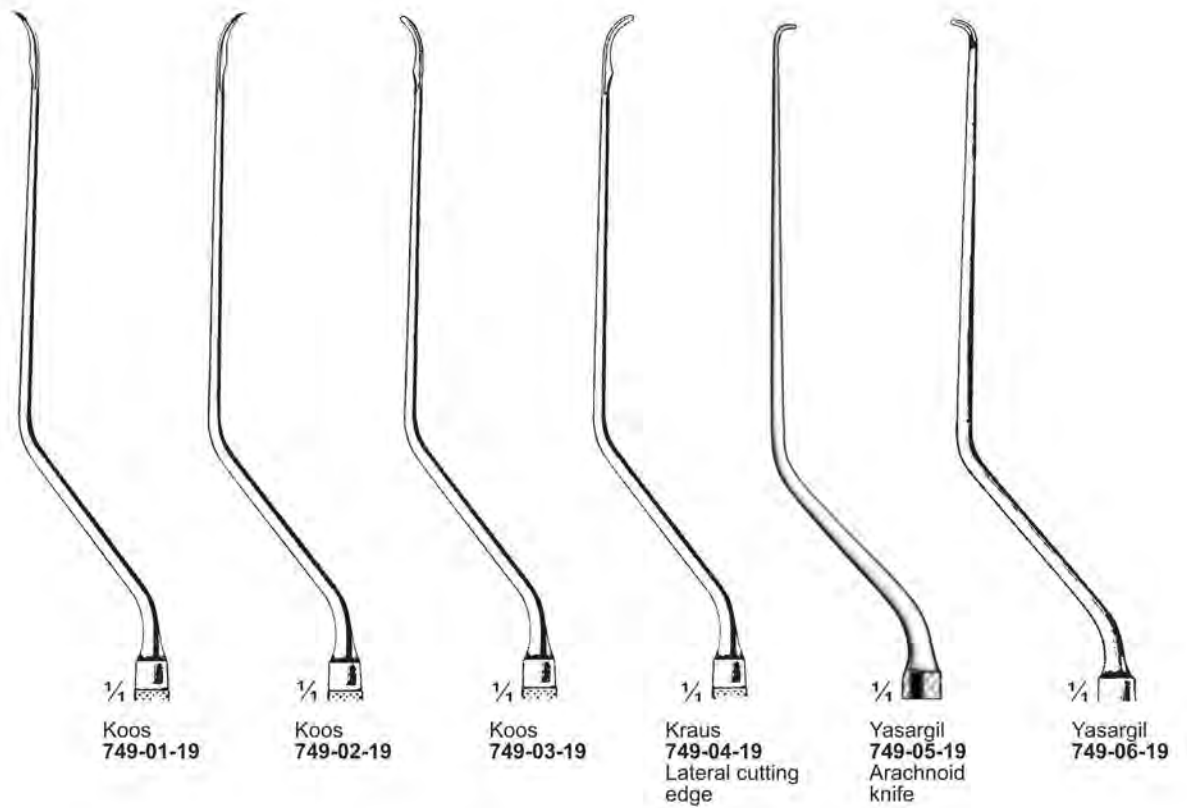

**Neurochirurgie  
Neurosurgery  
Neurochirurgie**



750-01-19 To 750-17-19  
19 cm / 7½"

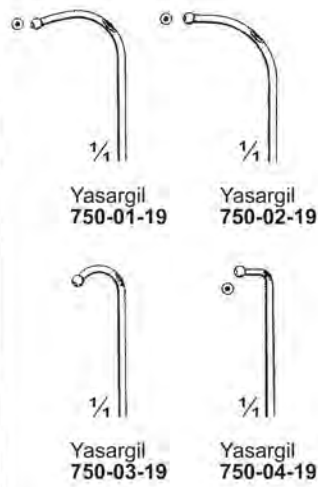

Yasargil  
750-01-19

Yasargil  
750-02-19

Yasargil  
750-03-19

Yasargil  
750-04-19

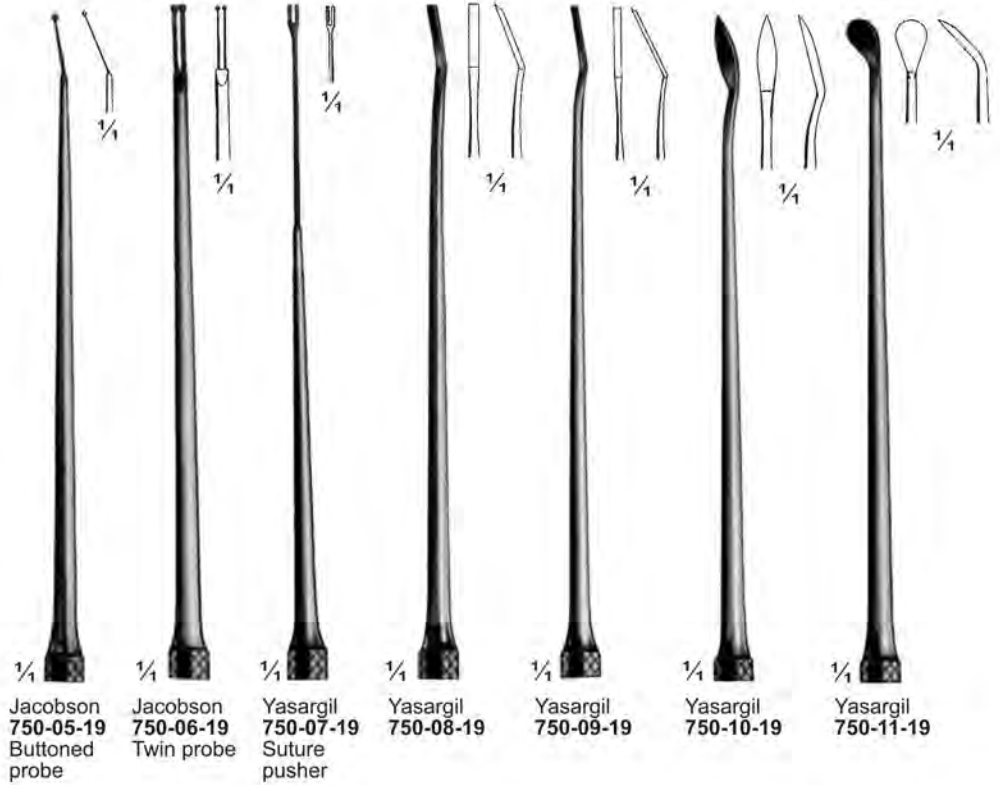

Jacobson  
750-05-19  
Buttomed  
probe

Jacobson  
750-06-19  
Twin probe

Yasargil  
750-07-19  
Suture  
pusher

Yasargil  
750-08-19

Yasargil  
750-09-19

Yasargil  
750-10-19

Yasargil  
750-11-19

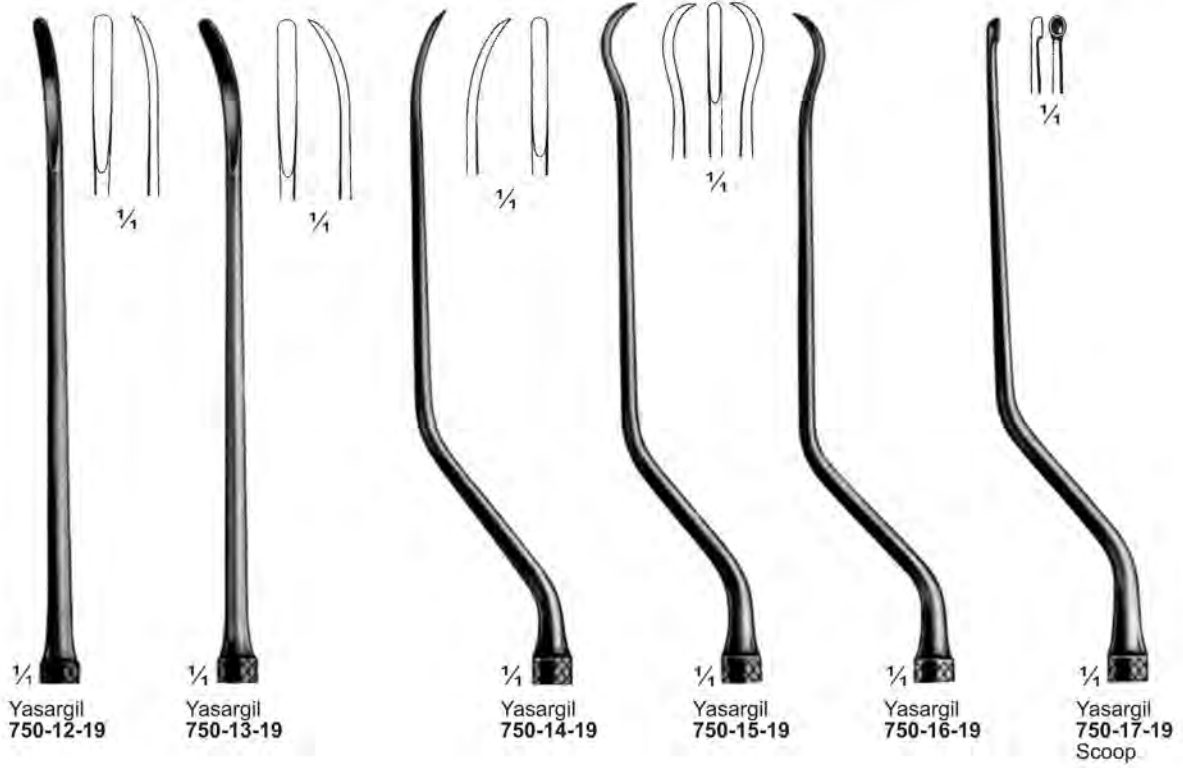

Yasargil  
750-12-19

Yasargil  
750-13-19

Yasargil  
750-14-19

Yasargil  
750-15-19

Yasargil  
750-16-19

Yasargil  
750-17-19  
Scoop

Neurochirurgie  
Neurosurgery  
Neurochirurgie

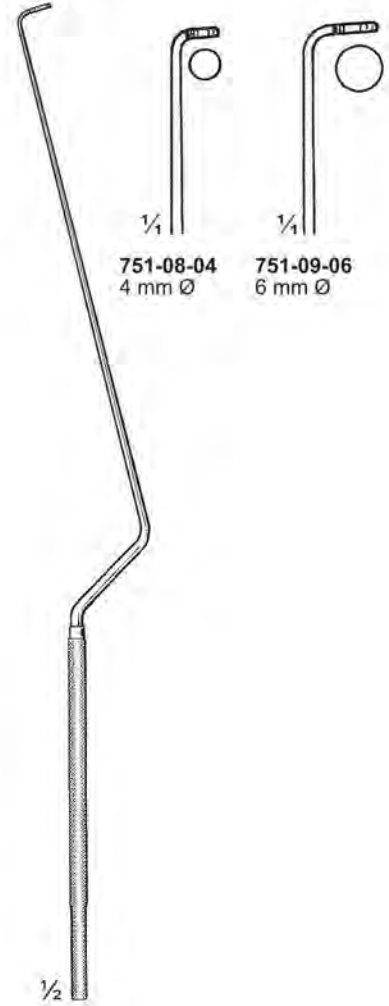
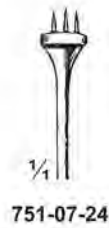
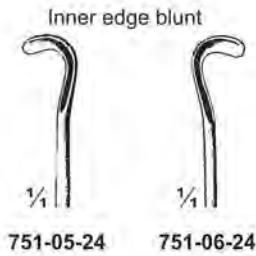
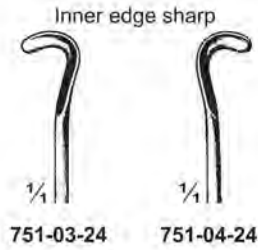
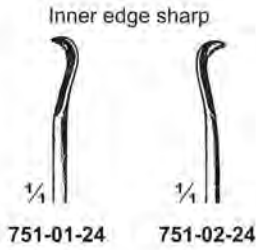

Hardy  
751-01-24 To 751-07-24  
24 cm / 9½"

Hardy  
751-08-04 To 751-09-06  
26 cm / 10¼"

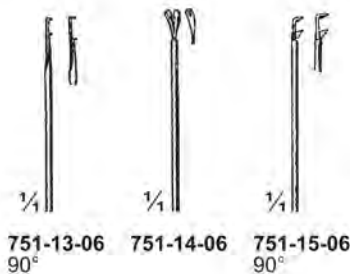
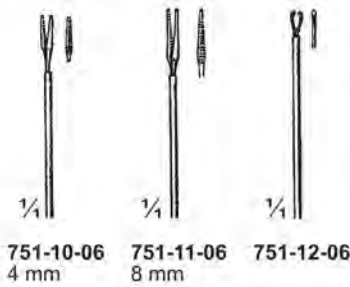

751-10-06 To 751-15-06  
Shaft length 6.5 cm / 2½"

751-16-06 To 751-19-06  
Shaft length 6.5 cm / 2½"

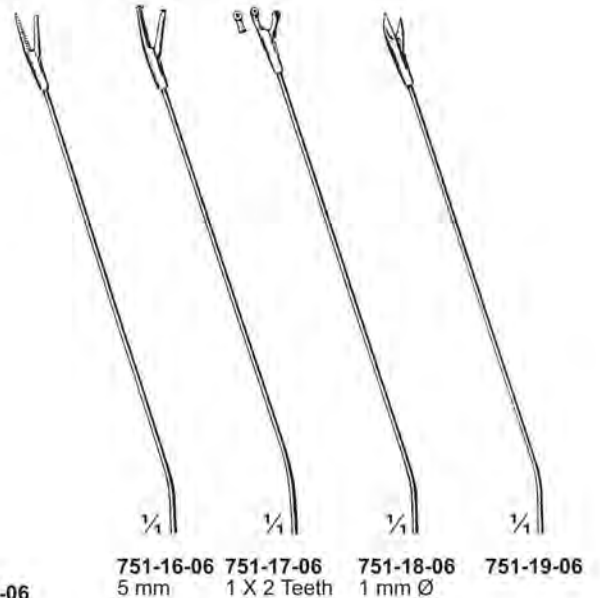



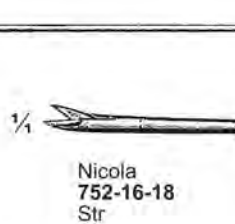
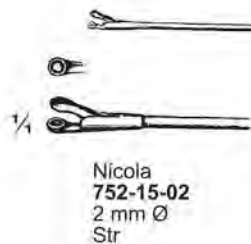
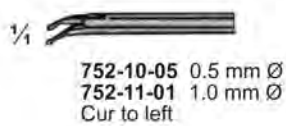
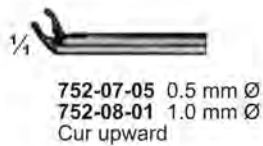
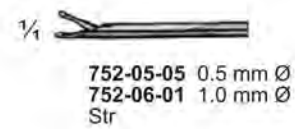

**752-01-14 To 752-04-14**  
Shaft length 14 cm / 5½"



**752-05-05 To 752-11-01**  
Shaft length 14 cm / 5½"

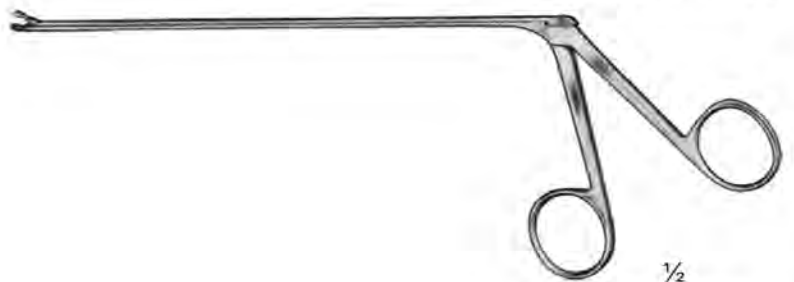

**752-12-02 To 752-13-03**  
Shaft length 14 cm / 5½"

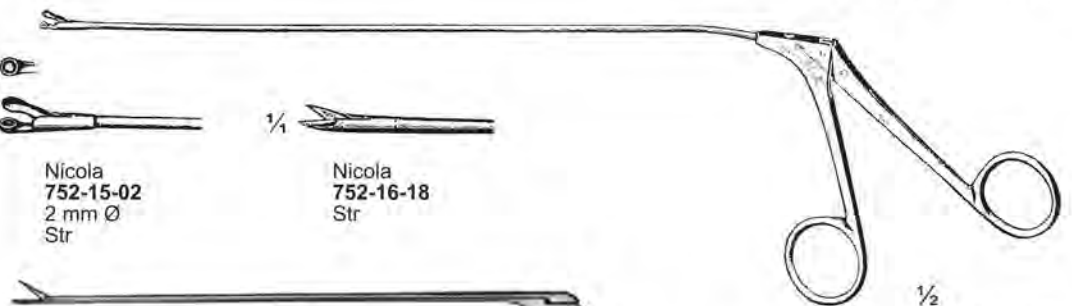

**752-14-18 To 752-16-18**  
Shaft length 18 cm / 7"

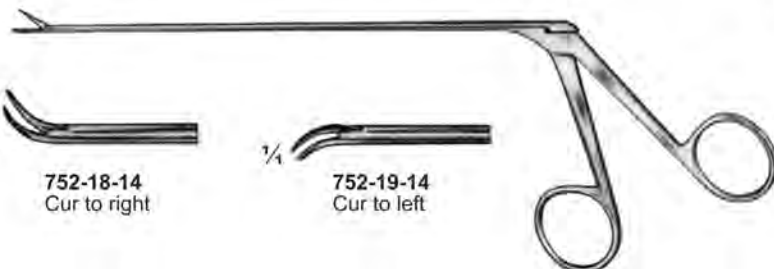

**752-17-14 To 752-19-14**  
Shaft length 14 cm / 5½"



753-01-18 18 cm / 7"  
753-02-22 22 cm / 8 3/4"

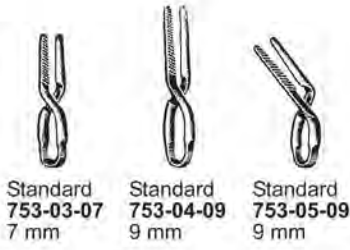

Standard 753-03-07 7 mm  
Standard 753-04-09 9 mm  
Standard 753-05-09 9 mm



Standard 753-06-09 9 mm  
Standard 753-07-09 9 mm



753-08-18 18 cm / 7"  
753-09-22 22 cm / 8 3/4"



Mini 753-10-04 4 mm  
Mini 753-11-06 6 mm

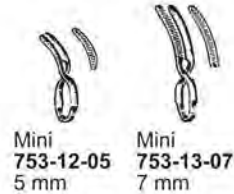

Mini 753-12-05 5 mm  
Mini 753-13-07 7 mm



753-14-18 18 cm / 7"

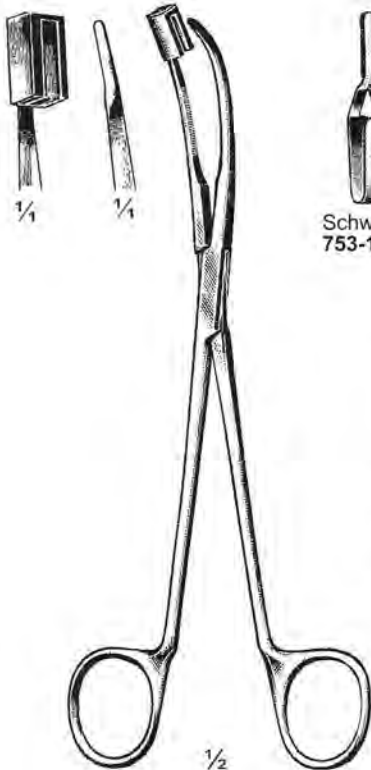

Schwartz 753-15-20 20 cm / 8"

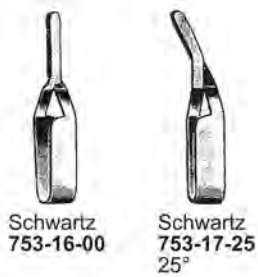

Schwartz 753-16-00  
Schwartz 753-17-25 25°



Schwartz 753-18-45 45°

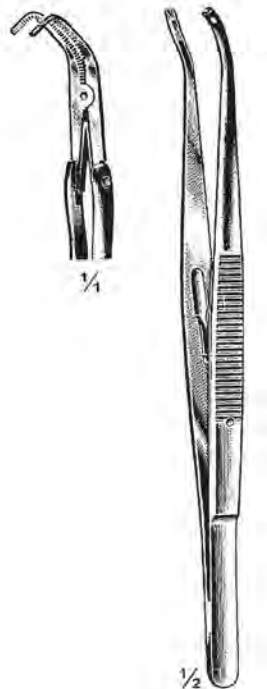

753-19-18 18 cm / 7"



Yasargil 753-20-25 25 mm



Yasargil 753-21-75 75 mm



Jacobson-Potts 753-22-15 15 cm / 6"

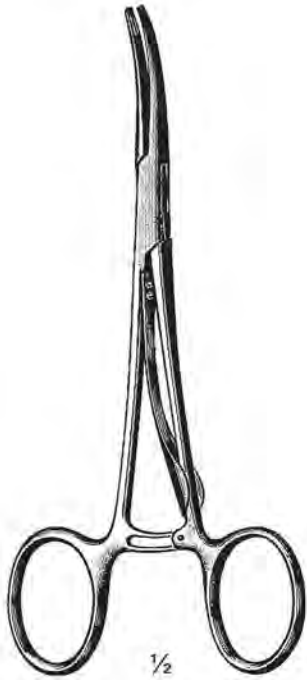

McKenzie  
754-01-15 15 cm / 6"  
754-02-18 18 cm / 7"



McKenzie  
754-03-15 15 cm / 6"  
754-04-18 18 cm / 7"



McKenzie Modif.  
754-05-18  
18 cm / 7"



Raney  
754-06-16  
16 cm / 6 1/4"



1/4

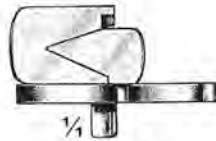

1/4



1/2  
Olivecrona-Toennis  
(Scoville)  
754-07-14  
Shaft length 14 cm / 5 1/2"

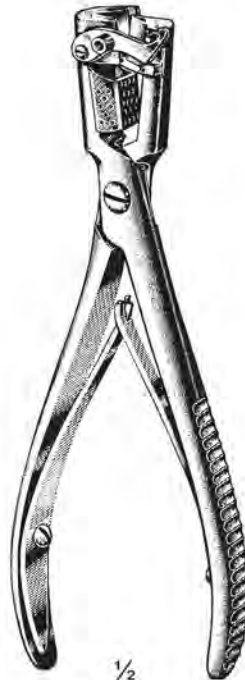

1/2  
Mc-Kenzie  
754-08-18  
18 cm / 7"



Gigli (Olivecrona)  
754-09-30 30 cm / 12"  
754-10-40 40 cm / 16"  
754-11-50 50 cm / 20"  
754-12-60 60 cm / 24"  
754-13-70 70 cm / 28"

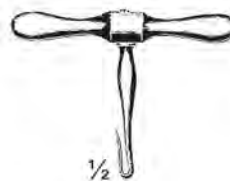

1/2  
Gigli  
754-14-06  
6 cm / 2 1/4"

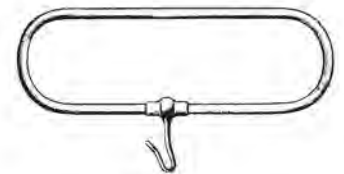

Gigli  
754-15-00



Martel  
755-01-33  
33 cm / 13"



Adson  
755-02-19  
19 cm / 7½"



Lebsche  
755-03-25  
25 cm / 10"



1/2  
Dahlgren  
755-04-20  
20 cm / 8"  
With one blade



1/2  
De Vibiss  
755-05-21  
21 cm / 8¼"  
With two blades

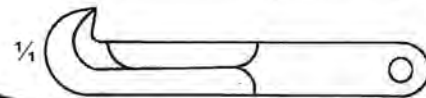
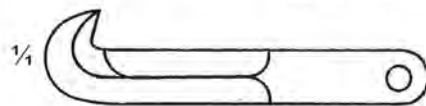

1/2  
Crutchfield  
755-06-00  
Cervical traction tongs  
Small size



Crutchfield  
756-01-00  
Cervical traction tongs  
Medium size



756-04-00  
Cervical traction tongs for extension  
of the neck vertebrae  
Large size

Drill points for traction tongs



756-02-03  
3.5 mm Ø



756-03-05  
5 mm Ø

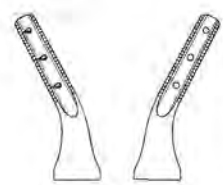

1/4



1/4



Yasargil  
756-05-31  
31 cm / 12 1/4"

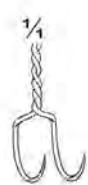

Yasargil  
756-06-41  
41 cm / 16 1/4"

**Duradisektoren  
Dura Dissectors  
Dissecteurs à dure-mère**



**Duradisektoren  
Dura Dissectors  
Dissecteurs à dure-mère**



Penfield  
758-01-20  
20 cm / 8"



Penfield  
758-02-20  
20 cm / 8"



Penfield  
758-03-18  
18 cm / 7"



Milligan  
758-04-21  
21 cm / 8 1/4"

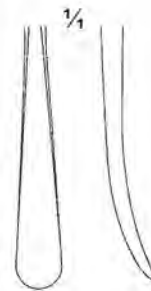
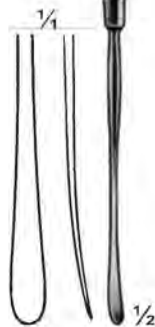
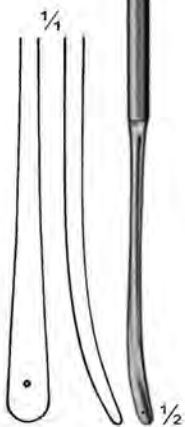
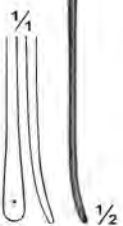
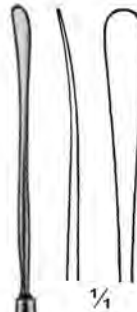
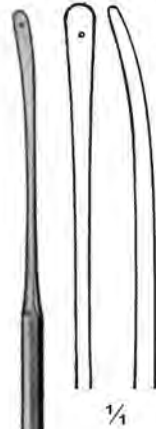

Olivecrona  
758-05-18 18 cm / 7"  
758-06-24 24 cm / 9 1/2"

Olivecrona  
758-07-18 18 cm / 7"  
758-08-24 24 cm / 9 1/2"

Davis  
758-09-24  
24.5 cm / 9 3/4"

758-10-22  
22 cm / 8 3/4"

Penfield  
758-11-29  
29 cm / 11 1/2"

**Neurochirurgie  
Neurosurgery  
Neurochirurgie**



Toennis  
759-01-15  
15 cm / 6"



Lahey  
759-02-13  
13 cm / 5 1/4"



Cushing  
759-03-14  
14 cm / 5 1/2"



Frazier  
759-04-13 To 759-07-18

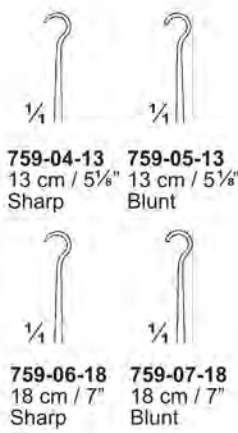

759-04-13 13 cm / 5 1/4" Sharp  
759-05-13 13 cm / 5 1/4" Blunt  
759-06-18 18 cm / 7" Sharp  
759-07-18 18 cm / 7" Blunt



Adson  
759-08-20  
20 cm / 8"



Adson  
759-09-20  
20 cm / 8"



Graham  
759-10-16  
16.5 cm / 6 1/2"



Sachs  
759-11-18  
18.5 cm / 7 1/4"



Cushing  
759-12-19 19 cm / 7 1/2"  
759-13-28 28 cm / 11"



Cushing  
759-14-19 19 cm / 7 1/2"  
759-15-28 28 cm / 11"



Dandy  
759-16-21  
21 cm / 8 1/4"



Dandy  
759-17-21  
21 cm / 8 1/4"



Dandy  
759-18-21  
21 cm / 8 1/4"



Smithwick  
759-19-17 To 759-20-21



759-19-17  
17 cm / 6 3/4"



759-20-21  
21 cm / 8 1/4"



**Neurochirurgie  
Neurosurgery  
Neurochirurgie**

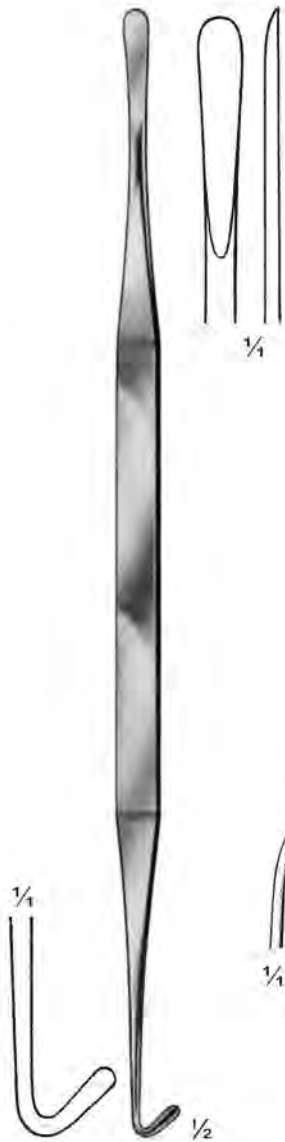

Smithwick  
760-01-30  
30 cm / 12"

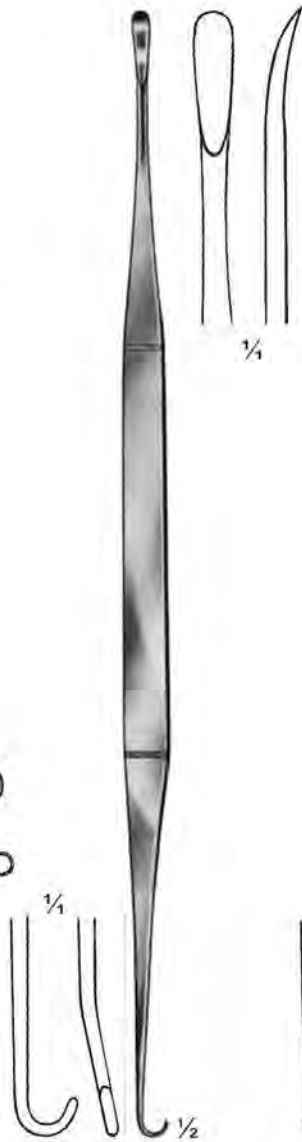

Scoville  
760-02-30  
30 cm / 12"

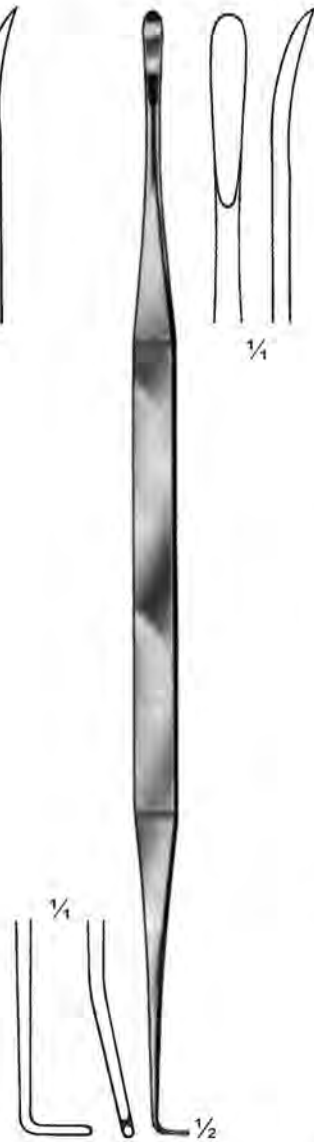

Scoville  
760-03-30  
30 cm / 12"



Scoville  
760-04-30  
30 cm / 12"

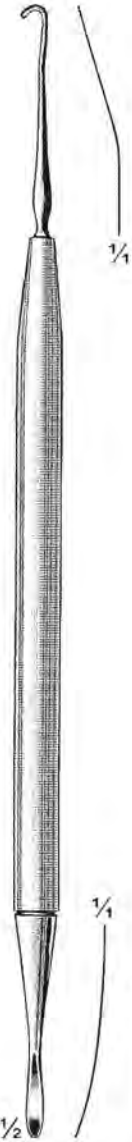

Scoville  
760-05-30  
30 cm / 12"



Nicola  
760-06-21  
21.5 cm / 8 1/2"

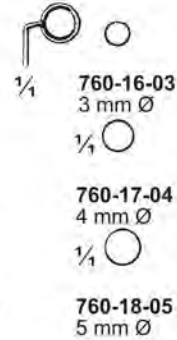
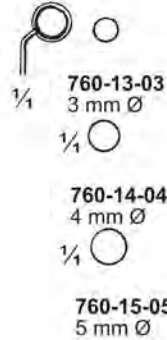
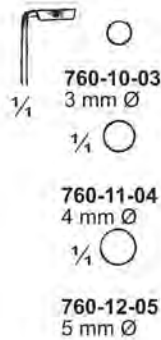
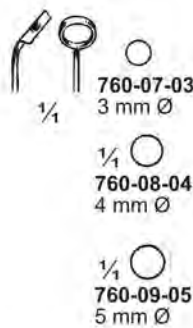

Ray  
760-07-03 To 760-18-05  
19 cm / 7 1/2"



761-01-25



761-02-25



761-03-25

Scoville  
761-01-25 To 761-03-25  
25 cm / 10"



Cushing  
761-15-19  
19 cm / 7½"



Cone  
761-04-04 To 761-06-09  
23 cm / 9"



761-04-04  
761-07-04  
4 mm Ø



761-05-07  
761-08-07  
7 mm Ø



761-06-09  
761-09-09  
9 mm Ø



Cushing  
761-16-19  
19 cm / 7½"



Cone  
761-07-04 To 761-09-09  
23 cm / 9"



Cushing  
761-10-05 To 761-14-12  
23.5 cm / 9¼"



Hoern  
761-17-22  
22 cm / 8¾"



761-10-05  
5 mm



761-11-07  
7 mm



761-12-09  
9 mm



761-13-10  
10 mm



761-14-12  
12 mm



Dandy  
761-18-20  
20 cm / 8"



**762-01-13**  
13 cm / 5 1/8"



**762-02-19**  
19 cm / 7 1/2"



**762-03-12**  
12.5 cm / 5"



**Bucy**  
**762-04-16 To 762-07-16**  
16.5 cm / 6 1/2"



**762-04-16**



**762-05-16**



**762-06-16**



**762-07-16**



**Frazier**  
**762-08-17**  
17 cm / 6 3/4"

**Toennis**  
**762-01-13 & 762-02-19**

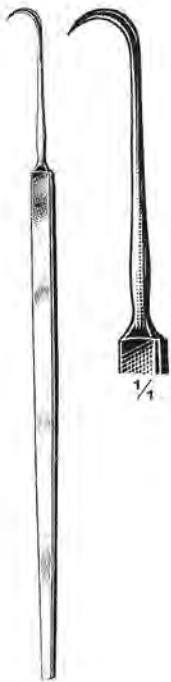

**Olivecrona**  
**762-09-17**  
17 cm / 6 3/4"



**Olivecrona**  
**762-10-23**  
23 cm / 9"



**Halle**  
**762-11-20**  
20 cm / 8"



**Woodson**  
**762-12-18**  
18 cm / 7"



**Woodson**  
**762-13-18**  
18 cm / 7"



**Nervwurzelhaken, Komedoneninstrumente**  
**Nerve Root Retractors, Comedone Extractors**  
**Tire-Comédons, Retracteurs pour racines nerveuses**

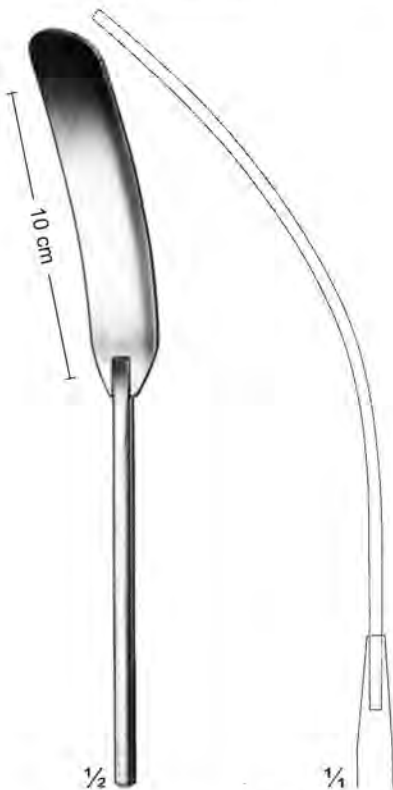

Heifetz  
**763-01-08 To 763-05-20**  
 20 cm / 8"  
 Malleable

<b>763-01-08</b>	8 mm
<b>763-02-11</b>	11 mm
<b>763-03-14</b>	14 mm
<b>763-04-17</b>	17 mm
<b>763-05-20</b>	20 mm

Cushing  
**763-06-08 To 763-0816**

**763-06-08**  
 17 cm / 6 3/4"  
 8 X 10 mm

**763-07-13**  
 20 cm / 8"  
 13 X 15 mm

**763-08-16**  
 28 cm / 11"  
 16 X 18 mm



Olivecrona  
 Concave  
**763-09-07**  
**763-10-11**  
**763-11-15**  
**763-12-18**  
 18 cm / 7"

Width of spatulas	
Upper end	Lower end
7 mm	9 mm
11 mm	13 mm
15 mm	18 mm
18 mm	22 mm

Olivecrona  
 Convex  
**763-13-07**  
**763-14-11**  
**763-15-15**  
**763-16-18**  
 18 cm / 7"

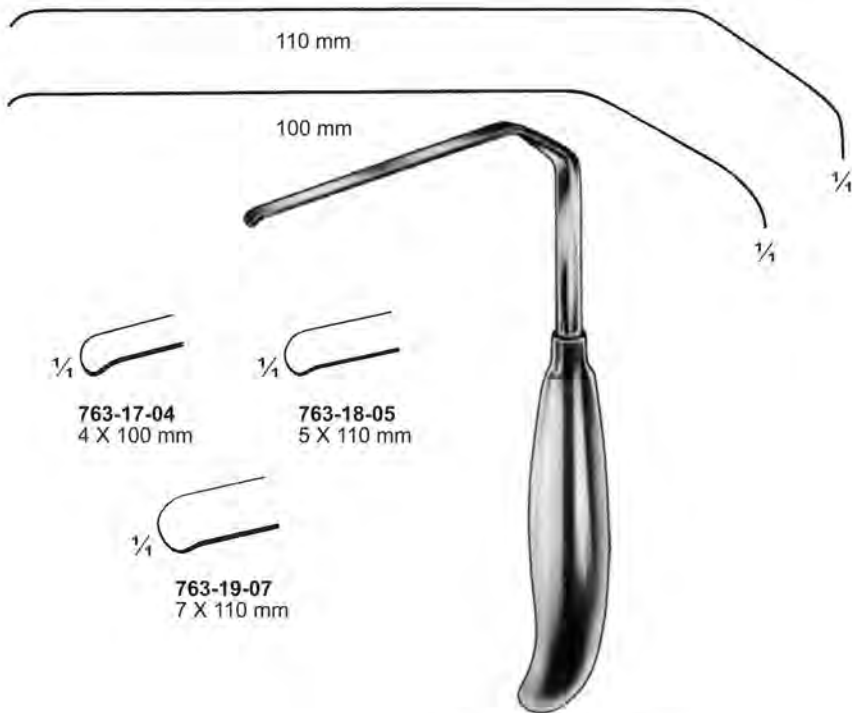

**763-17-04**  
 4 X 100 mm

**763-18-05**  
 5 X 110 mm

**763-19-07**  
 7 X 110 mm

**763-17-04 To 763-19-07**

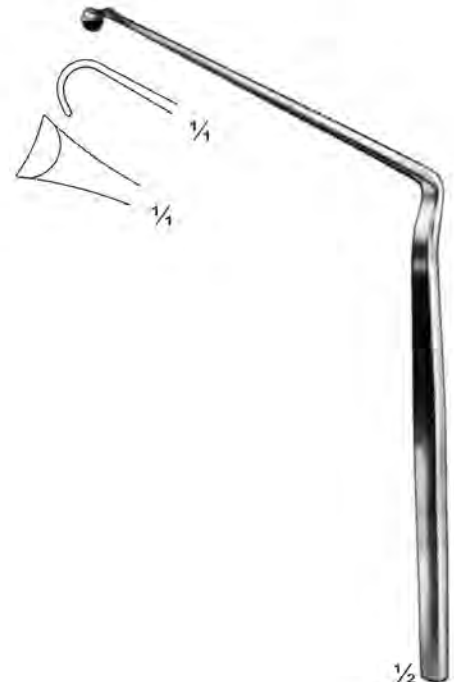

**763-20-21**  
 21 cm / 8 1/4"



**Nervwurzelhaken, Komedoneninstrumente**  
**Nerve Root Retractors, Comedone Extractors**  
**Tire-Comédons, Retracteurs pour racines nerveuses**



Scoville  
764-01-23  
23 cm / 9"

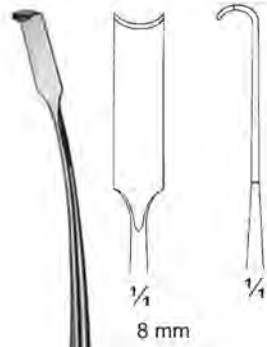

1/2  
Scoville  
764-02-24  
24 cm / 9 1/2"

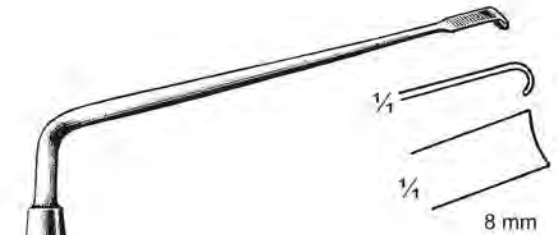

Scoville  
764-03-23  
23 cm / 9"



Love  
764-04-21  
21 cm / 8 1/4"



Oldberg  
764-05-19 To 764-08-19  
21 cm / 8 1/4"



764-05-19  
19 mm



764-06-13  
13 mm



764-07-15  
15 mm



764-08-19  
19 mm

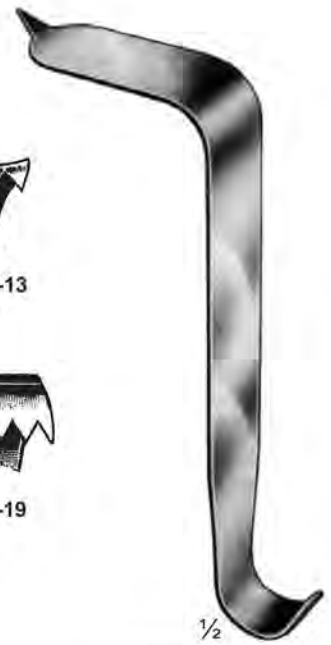

Taylor  
764-09-30 30 X 70 mm  
764-10-30 30 X 100 mm  
17 cm / 6 3/4"

**Lupusküretten  
Lupus Currettes  
Curettes pour les lupus**



Moncorps  
765-01-13  
13 cm / 5 1/8"



Vidal  
765-02-14  
14 cm / 5 1/2"



Piffard  
765-03-14 To 765-05-14  
14.5 cm / 5 3/4"

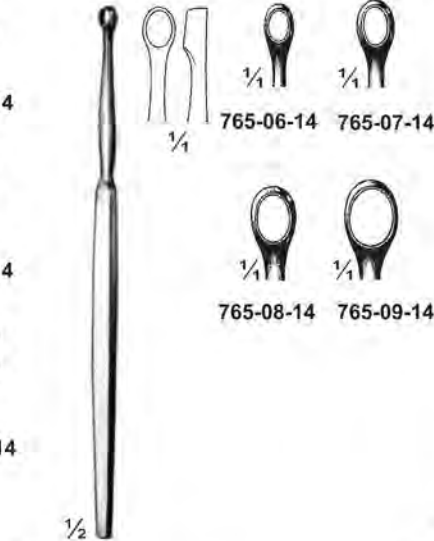

Fox  
765-06-14 To 765-09-14  
14.5 cm / 5 3/4"

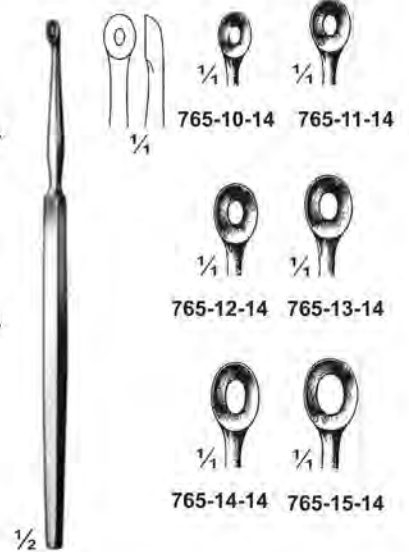

Wolff  
765-10-14 To 765-15-14  
14.5 cm / 5 3/4"

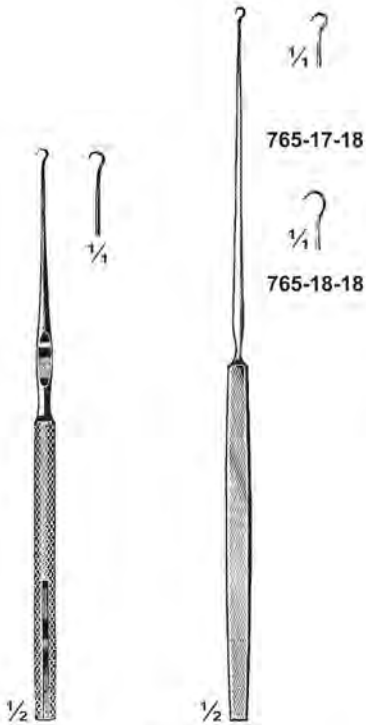

Kilner  
765-16-15  
15 cm / 6"

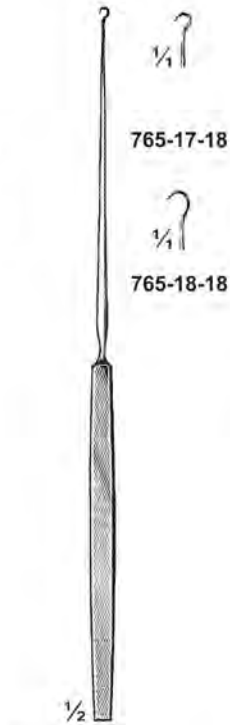

Gillies  
765-17-18 & 765-18-18  
18 cm / 7"



765-19-13  
13 cm / 5 1/8"



765-20-13  
13 cm / 5 1/8"



Katsch  
765-21-14  
14 cm / 5 1/2"



Unna-Vidal  
765-22-11  
11.5 cm / 4 1/2"

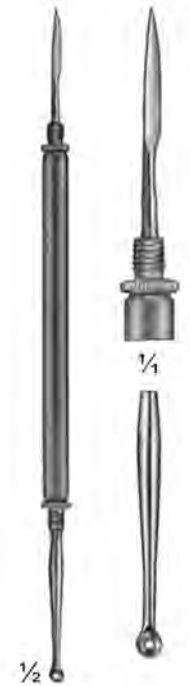

Hebra  
765-23-18  
18 cm / 7"

**Face-Lift-Haken, Komedoneninstrumente**  
**Face-lift Hooks, Comedone Extractors**  
**Face-lift Crochet, Tire-comédons**

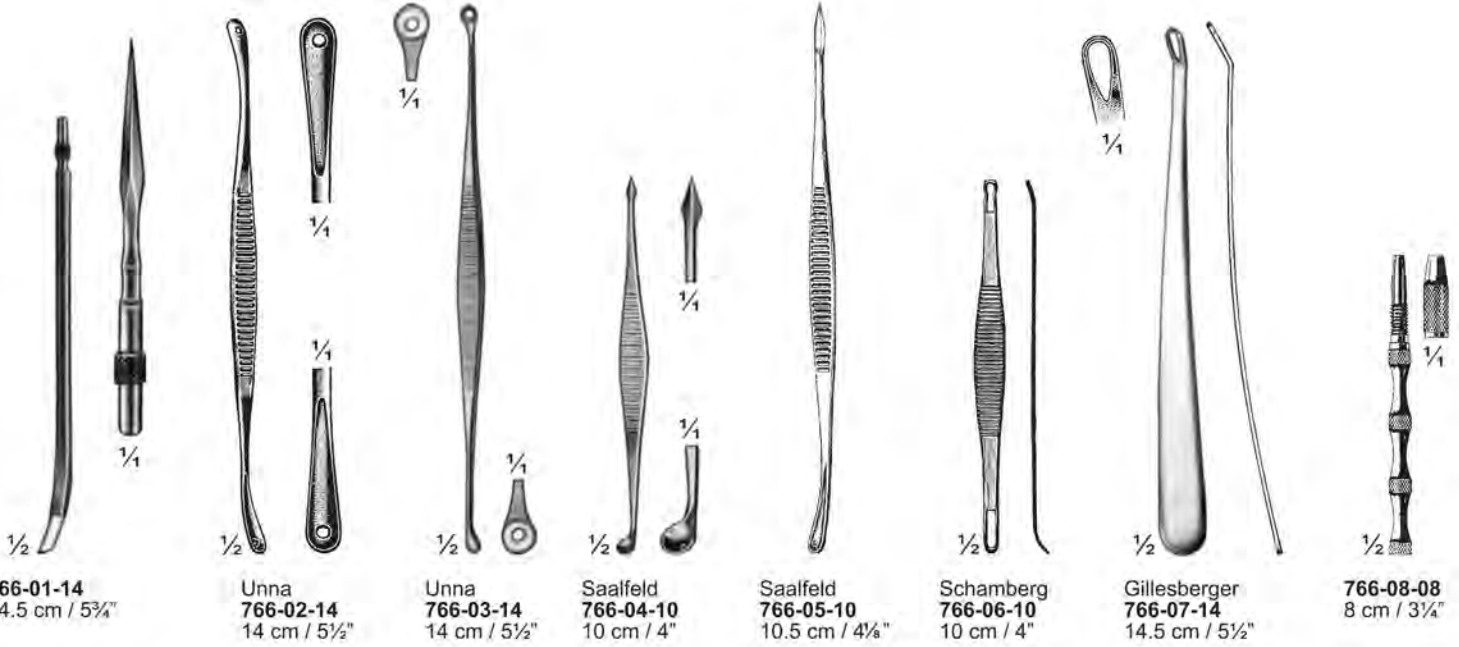

**766-01-14**  
14.5 cm / 5¾"

**Unna 766-02-14**  
14 cm / 5½"

**Unna 766-03-14**  
14 cm / 5½"

**Saalfeld 766-04-10**  
10 cm / 4"

**Saalfeld 766-05-10**  
10.5 cm / 4¼"

**Schamberg 766-06-10**  
10 cm / 4"

**Gillesberger 766-07-14**  
14.5 cm / 5½"

**766-08-08**  
8 cm / 3¼"

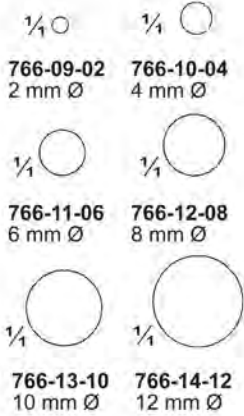

**766-09-02** 2 mm Ø

**766-10-04** 4 mm Ø

**766-11-06** 6 mm Ø

**766-12-08** 8 mm Ø

**766-13-10** 10 mm Ø

**766-14-12** 12 mm Ø

**766-13-10** 10 mm Ø

**766-14-12** 12 mm Ø

**766-13-10** 10 mm Ø

**766-14-12** 12 mm Ø



**766-09-02 To 766-14-12**  
6 cm / 2"

**Keys 766-15-02 To 766-21-08**  
10 cm / 4"

**Keys 766-22-02 To 766-28-08**  
11.5 cm / 5½"

**Keys 766-29-02 To 766-35-08**  
9 cm / 3½"



¼



**Keys 766-36-06**  
Dermal punch complete with 6 interchangeable tips, handle and rack

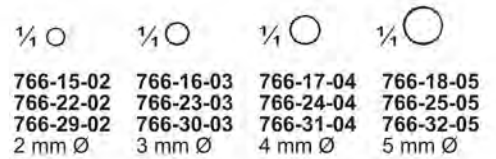

**766-15-02** 2 mm Ø

**766-16-03** 3 mm Ø

**766-17-04** 4 mm Ø

**766-18-05** 5 mm Ø

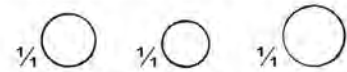

**766-19-06** 6 mm Ø

**766-20-07** 7 mm Ø

**766-21-08** 8 mm Ø

**Darm-und Gewebefasszangen**  
**Intestinal and Tissue Grasping Forceps**  
**Pinces pour saisir intestins et tissus**



Allis-Adair  
**767-01-15**  
 15 cm / 6"  
 10 X 11 Teeth

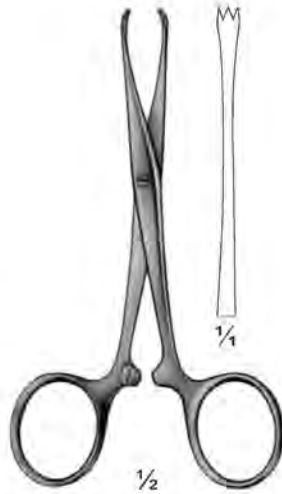

Chaput  
**767-02-12**  
 12.5 cm / 5"  
 2 X 3 Teeth

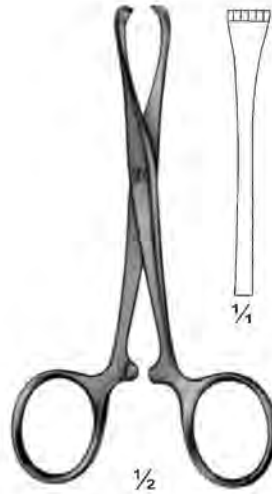

Tuffier  
**767-03-12**  
 12.5 cm / 5"  
 5 X 6 Teeth

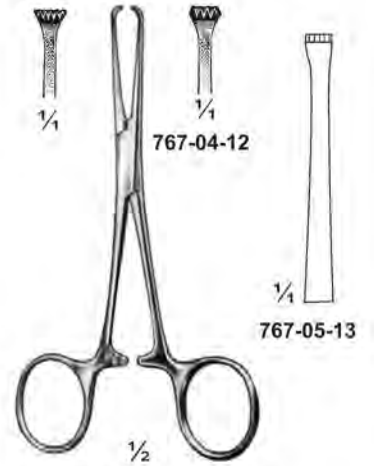

Allis-Baby  
**767-04-12** 12 cm / 4 3/4"  
**767-05-13** 13 cm / 5 1/8"  
 4 X 5 Teeth



Boys-Allis  
**767-06-15**  
 15 cm / 6"  
 5 X 6 Teeth

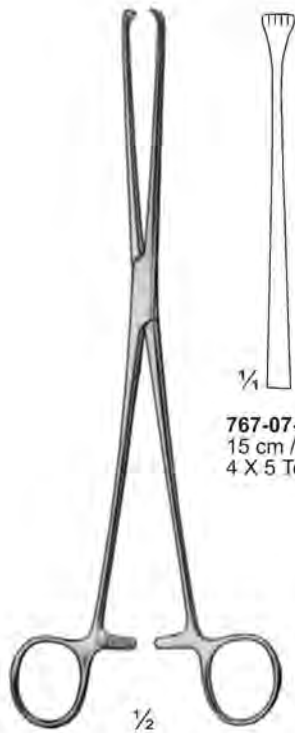

Allis  
**767-07-15 To 767-10-25**



**767-07-15**  
 15 cm / 6"  
 4 X 5 Teeth



**767-08-15**  
 15 cm / 6"  
 5 X 6 Teeth

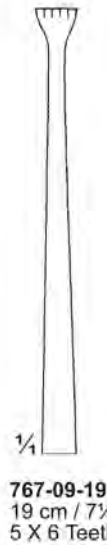

**767-09-19**  
 19 cm / 7 1/2"  
 5 X 6 Teeth

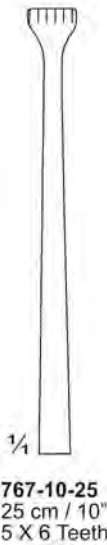

**767-10-25**  
 25 cm / 10"  
 5 X 6 Teeth



Allis  
**767-11-22**  
 22 cm / 8 3/4"  
 5 X 6 Teeth



**Darm-und Gewebefasszangen**  
**Intestinal and Tissue Grasping Forceps**  
**Pinces pour saisir intestins et tissus**

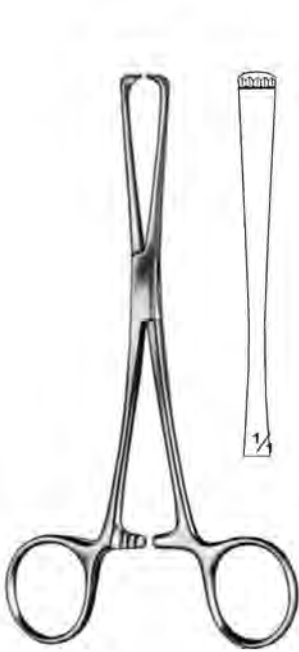

Lockwood-Allis  
 768-01-16 16 cm / 6 1/4"  
 768-02-20 20 cm / 8"  
 4 X 5 Teeth

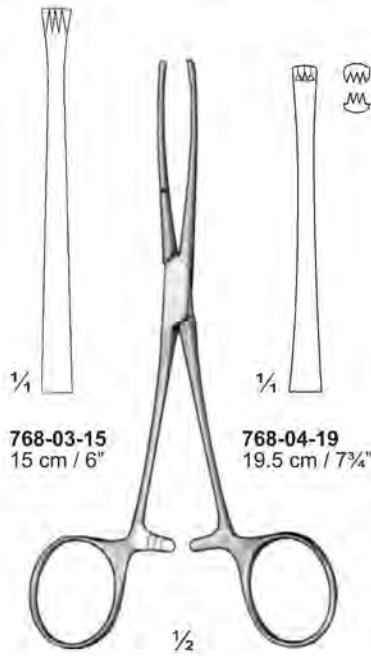

Judd-Allis  
 768-03-15 & 768-04-19  
 3 X 4 Teeth

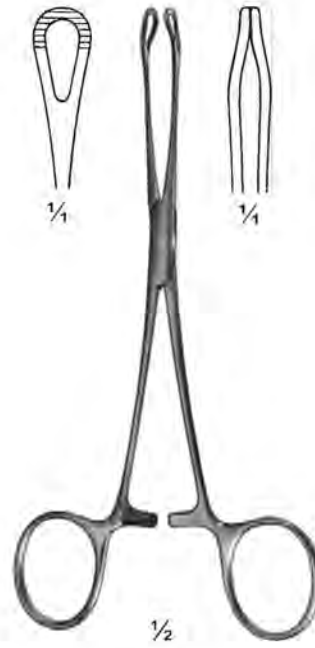

Williams  
 768-05-16  
 16 cm / 6 1/4"



Allis-Niro  
 768-06-15  
 15 cm / 6"  
 4 X 5 Teeth



Thoms-Allis  
 768-07-20  
 20 cm / 8"  
 6 X 7 Teeth

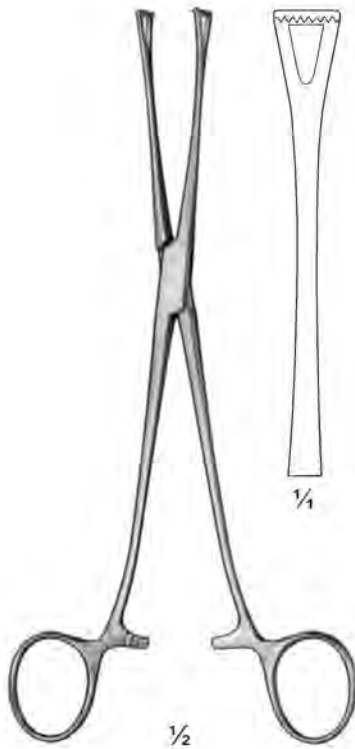

Lockwood  
 768-08-20  
 20 cm / 8"

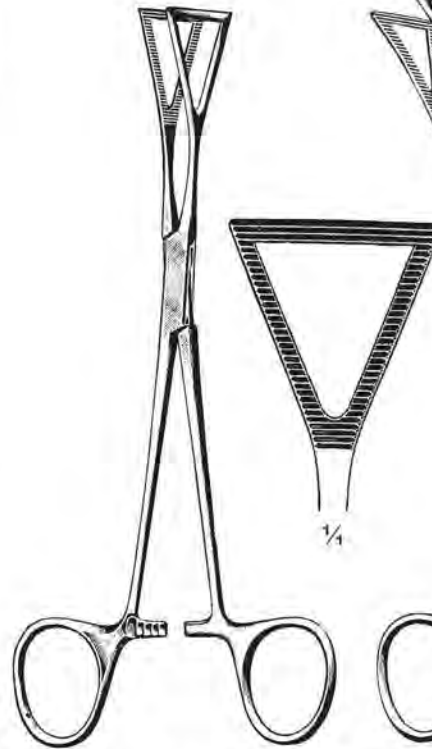

Lovelace  
 768-09-20  
 20 cm / 8"

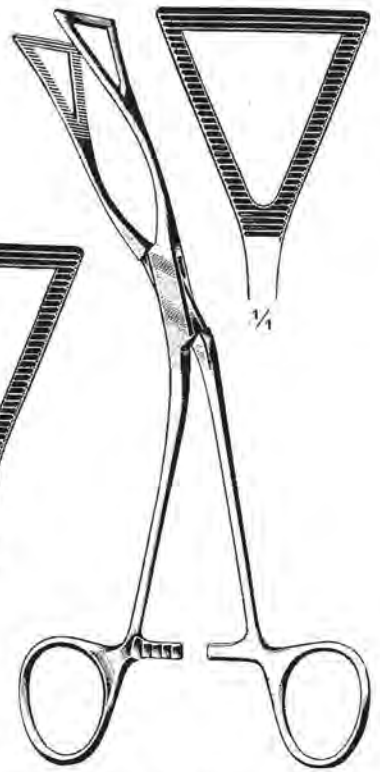

Lovelace  
 768-10-20  
 20 cm / 8"

**Darm-und Gewebefasszangen**  
**Intestinal and Tissue Grasping Forceps**  
**Pinces pour saisir intestins et tissus**

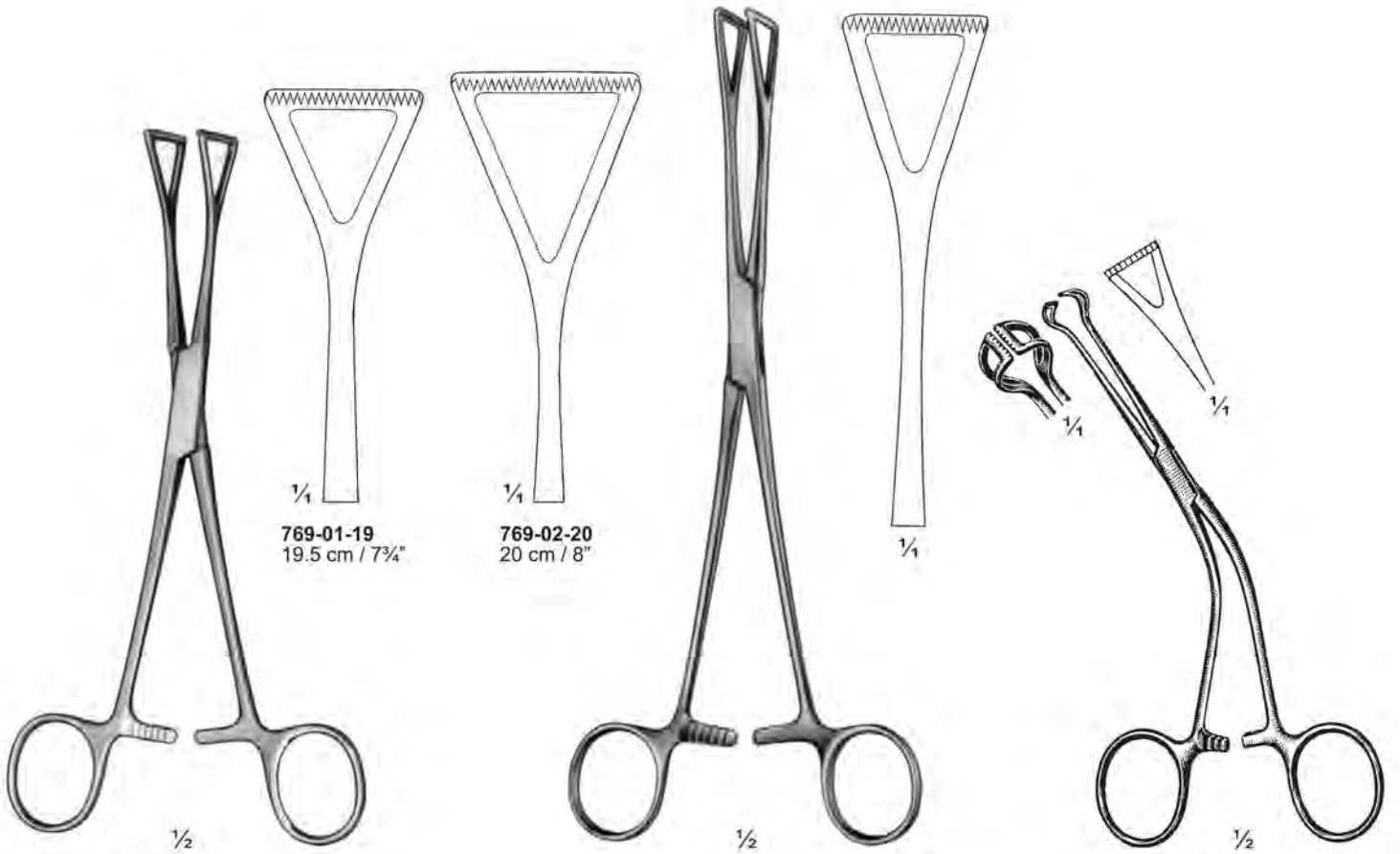

Duval-Collin  
769-01-19 & 769-02-20

Duval  
769-03-23  
23 cm / 9"

Allis-Babcock  
769-04-16  
16 cm / 6 1/4"

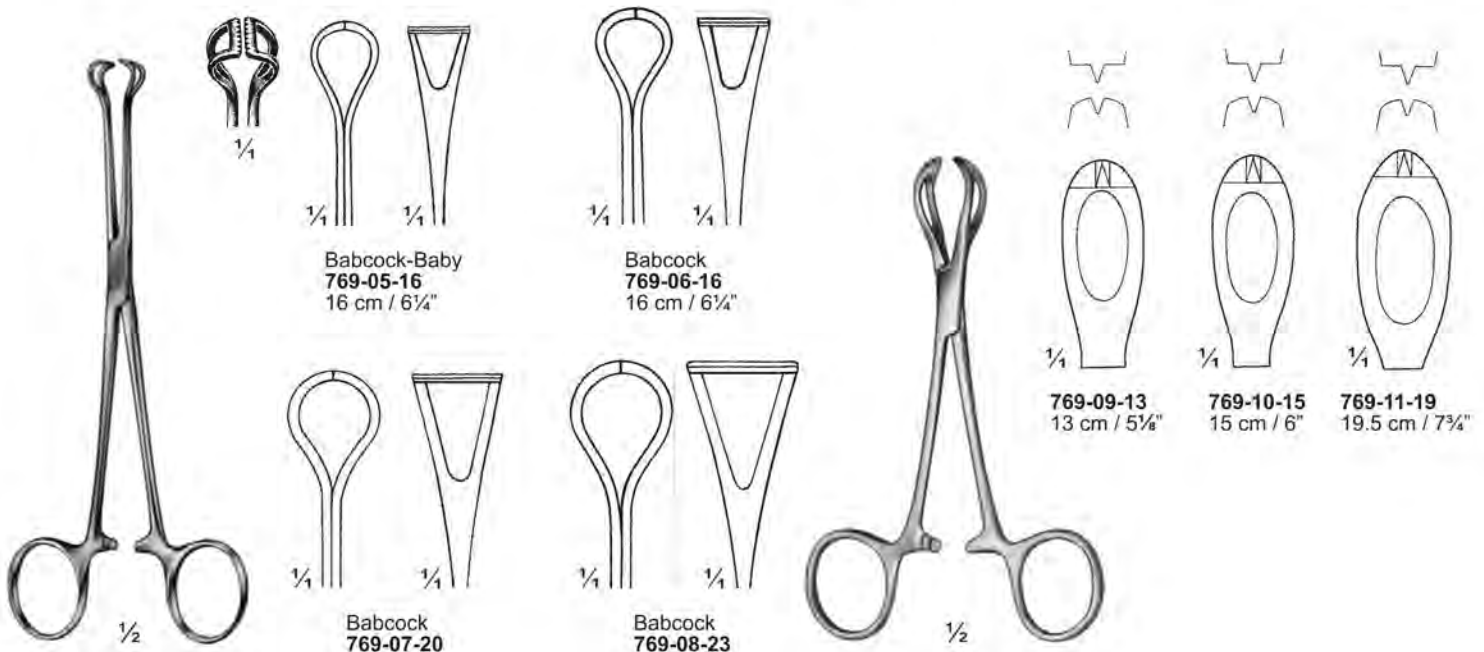

769-05-16 To 769-08-23

Babcock  
769-07-20  
20 cm / 8"

Babcock  
769-08-23  
23 cm / 9"

Lane  
769-09-13 To 769-11-19

769-09-13  
13 cm / 5 1/4"

769-10-15  
15 cm / 6"

769-11-19  
19.5 cm / 7 3/4"

**Darm-und Gewebefasszangen**  
**Intestinal and Tissue Grasping Forceps**  
**Pinces pour saisir intestins et tissus**

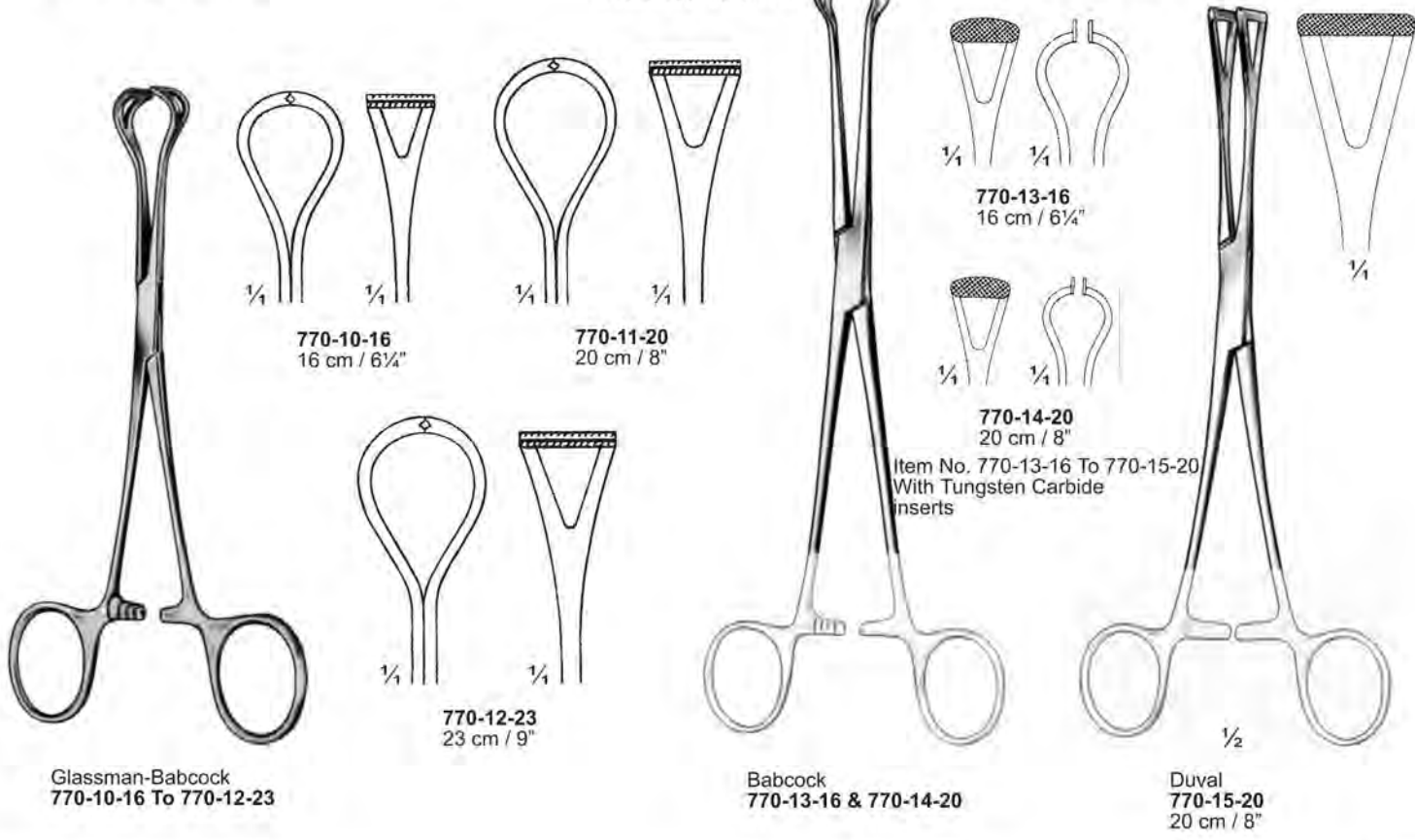
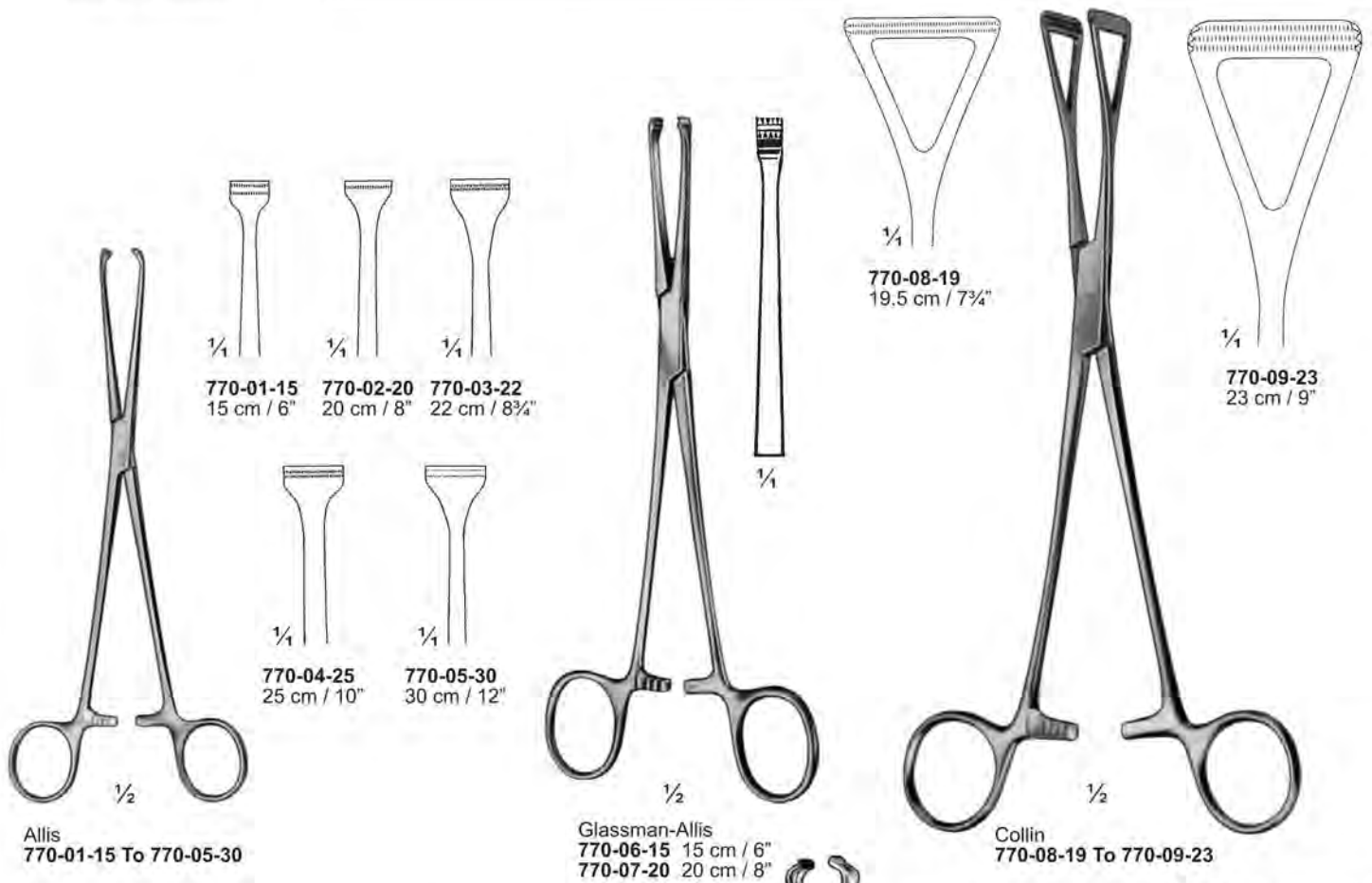

# Chirurgische Pinzetten Dissecting Forceps Pincès à dissection à griffes

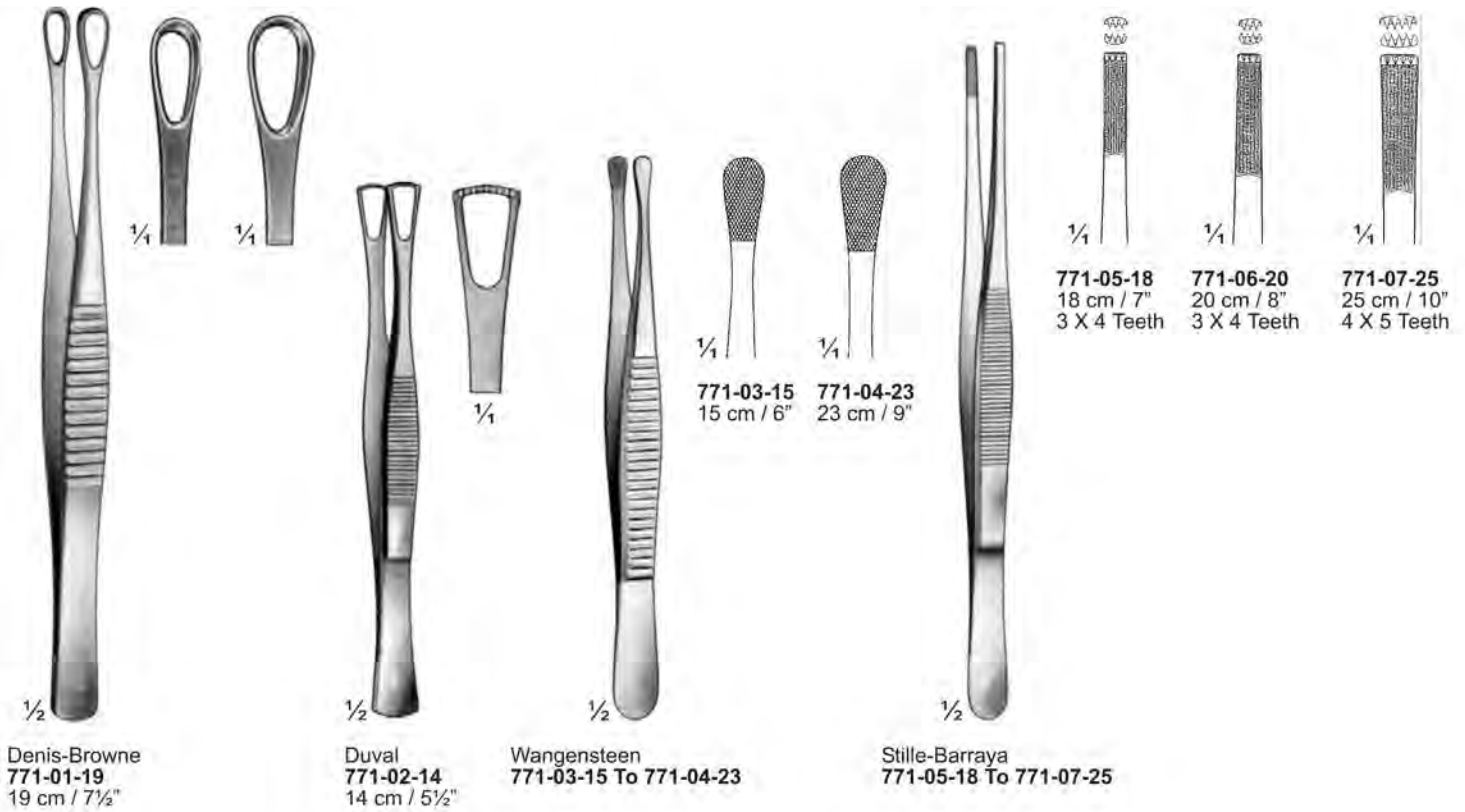

## ULTRA LIGHT FORCEPS

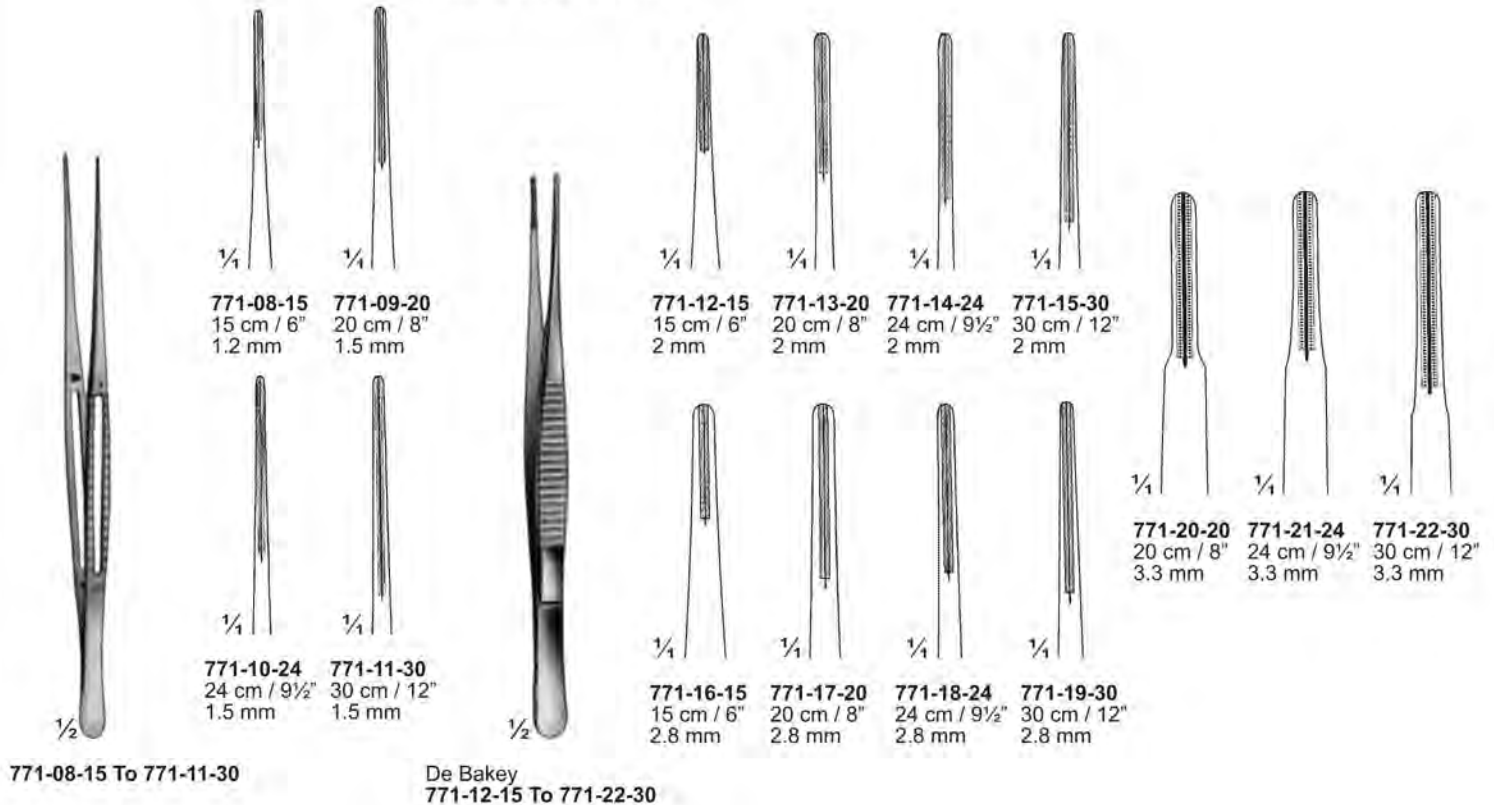

**Darmklemmen  
Intestinal Clamps  
Pincas intestinales**



$\frac{1}{4}$   
772-01-15



Banbridge  
772-01-15 To 772-02-15  
15 cm / 6"

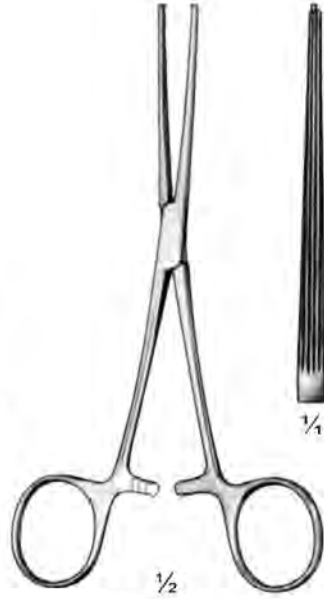

$\frac{1}{4}$

Allen  
772-03-15  
15 cm / 6"



$\frac{1}{4}$   
772-04-13



Baby-Kocher  
772-04-13 To 772-05-13  
13 cm / 5 $\frac{1}{8}$ "  
Very elastic blades



$\frac{1}{4}$   
772-06-16  
16.5 cm / 6 $\frac{1}{2}$ "

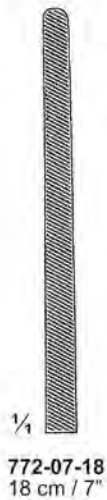

Doyen  
772-06-16 To 772-09-18



$\frac{1}{4}$   
772-10-20



Hartmann  
772-10-20 To 772-11-20  
20 cm / 8"

Darmklemmen  
Intestinal Clamps  
Pincas intestinales

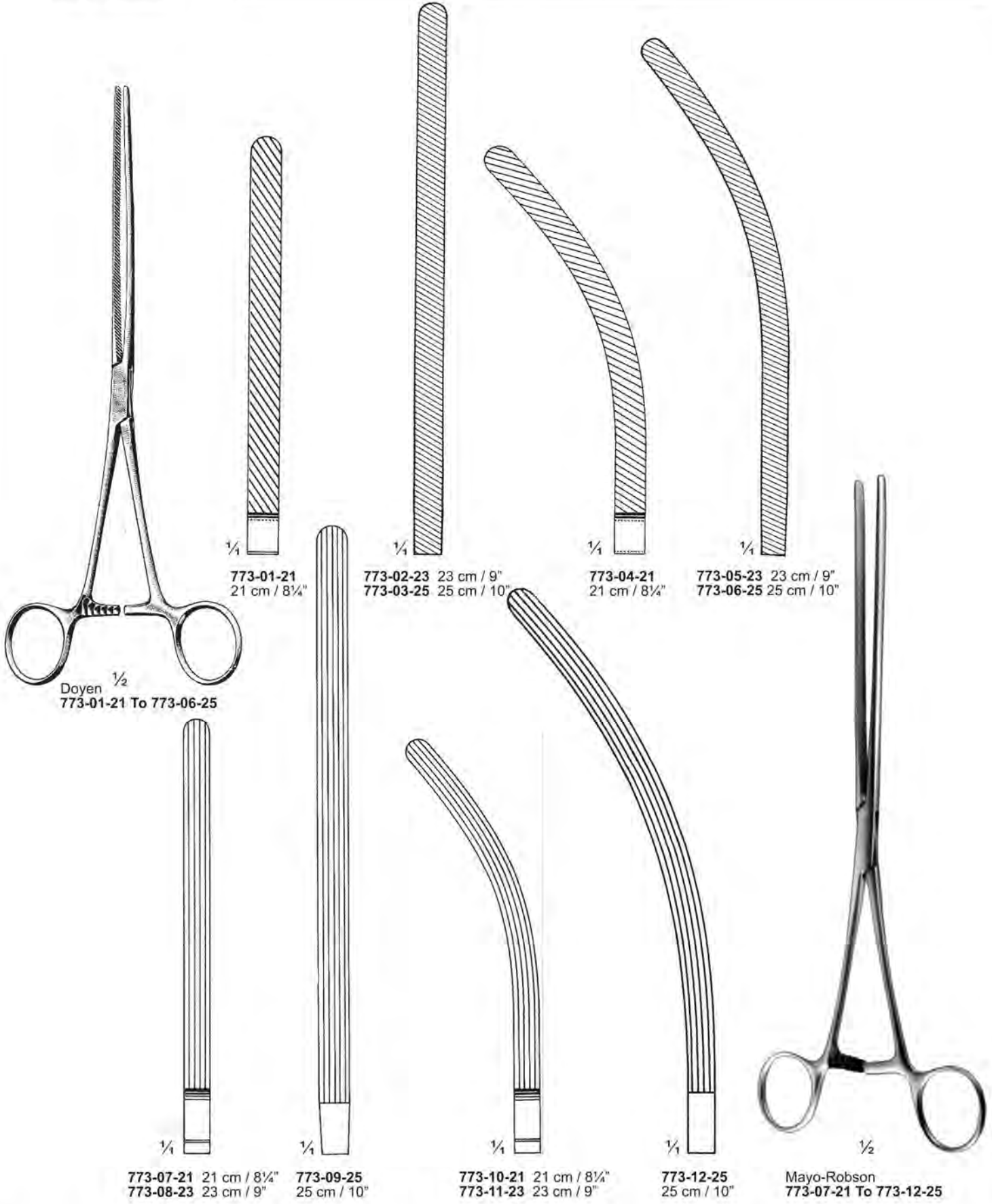

Doyen  $\frac{1}{2}$   
773-01-21 To 773-06-25



773-01-21 21 cm / 8 $\frac{1}{4}$ "



773-02-23 23 cm / 9"

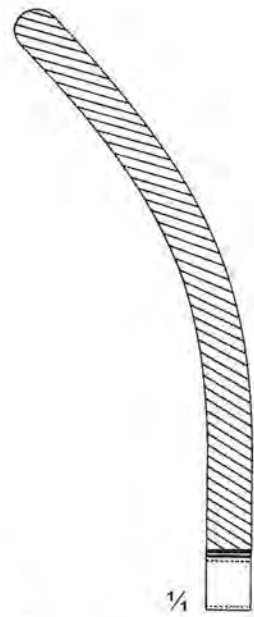

773-03-25 25 cm / 10"



773-04-21 21 cm / 8 $\frac{1}{4}$ "

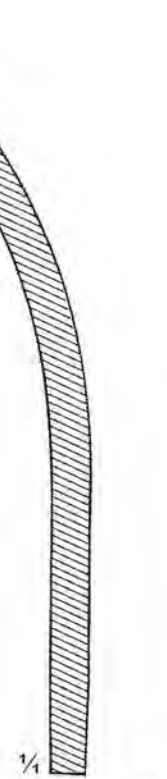

773-05-23 23 cm / 9"  
773-06-25 25 cm / 10"

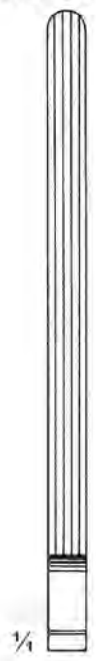

773-07-21 21 cm / 8 $\frac{1}{4}$ "



773-08-23 23 cm / 9"

773-09-25 25 cm / 10"

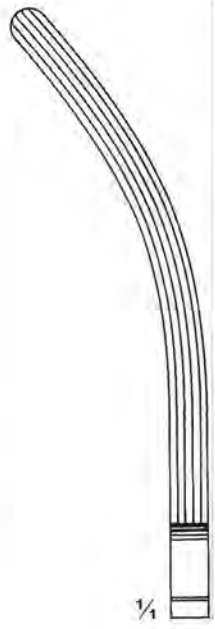

773-10-21 21 cm / 8 $\frac{1}{4}$ "

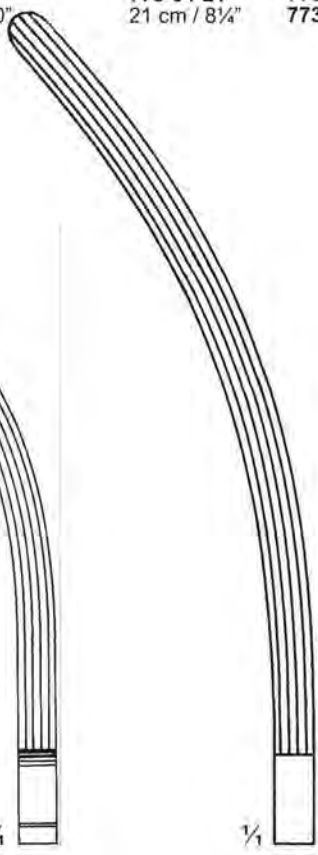

773-11-23 23 cm / 9"



773-12-25 25 cm / 10"



Mayo-Robson  $\frac{1}{2}$   
773-07-21 To 773-12-25

Darmklemmen  
Intestinal Clamps  
Pincas intestinales

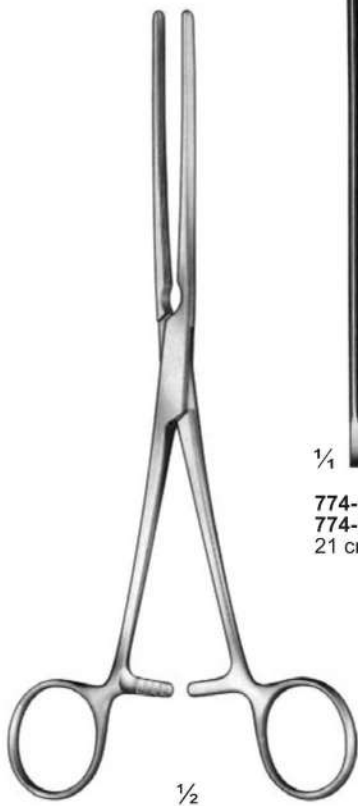

Kocher  
774-01-21 To 774-06-28  
Very elastic blades



774-01-21  
774-07-21  
21 cm / 8 1/4"



774-02-23  
774-08-23  
23 cm / 9"



774-03-25  
774-09-25  
25 cm / 10"

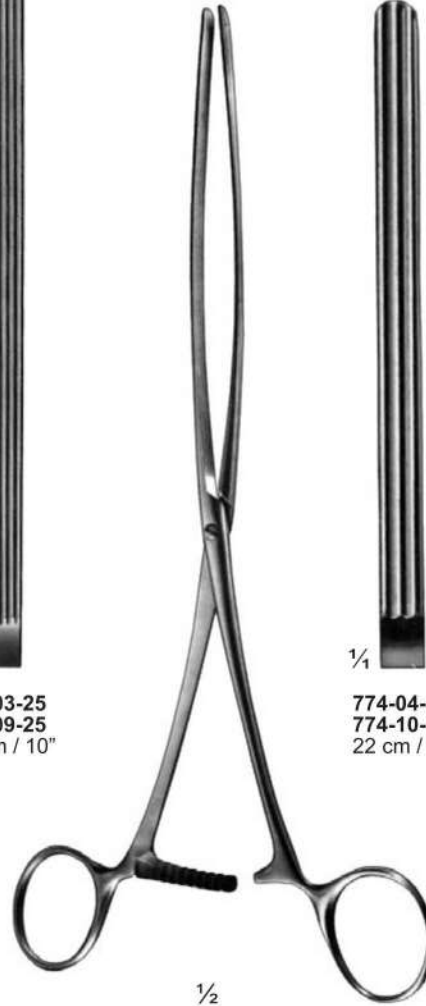

Kocher  
774-07-21 To 774-12-28  
Very elastic blades



774-04-22  
774-10-22  
22 cm / 8 3/4"



774-05-25  
774-11-25  
25 cm / 10"



774-06-28  
774-12-28  
28 cm / 11"

Darmklemmen  
 Intestinal Clamps  
 Pincas intestinales



$\frac{1}{4}$   
 775-01-21  
 775-07-21  
 21 cm / 8 $\frac{1}{4}$ "

$\frac{1}{4}$   
 775-02-23  
 775-08-23  
 23 cm / 9"

$\frac{1}{4}$   
 775-03-25  
 775-09-25  
 25 cm / 10"

$\frac{1}{4}$   
 775-04-22  
 775-10-22  
 22 cm / 8 $\frac{3}{4}$ "

$\frac{1}{4}$   
 775-05-25  
 775-11-25  
 25 cm / 10"

$\frac{1}{4}$   
 775-06-28  
 775-12-28  
 28 cm / 11"

$\frac{1}{2}$

Kocher  
 775-01-21 To 775-06-28  
 Very elastic blades

$\frac{1}{2}$

Kocher  
 775-07-21 To 775-12-28  
 Very elastic blades



Darmklemmen  
Intestinal Clamps  
Pincas intestinales



$\frac{1}{2}$   
776-01-60 & 776-02-80  
23 cm / 9"



776-01-60  
60 mm

$\frac{1}{4}$



776-02-80  
80 mm

$\frac{1}{4}$

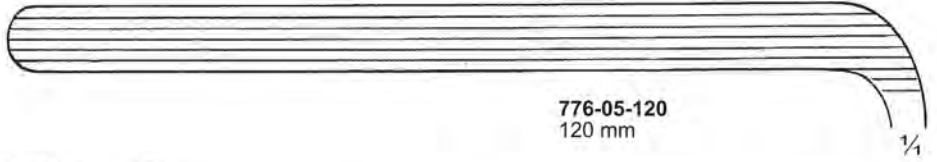

776-05-120  
120 mm

$\frac{1}{4}$

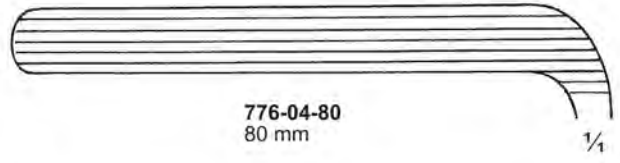

776-04-80  
80 mm

$\frac{1}{4}$

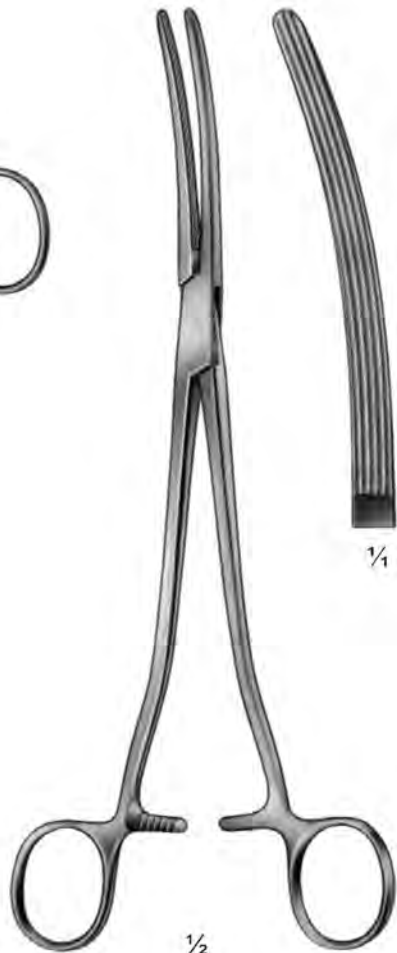

$\frac{1}{2}$   
Parker-Kerr  
776-03-25  
25 cm / 10"

$\frac{1}{4}$



$\frac{1}{2}$   
Mikulicz  
776-04-80 To 776-05-120  
19 cm / 7½"

$\frac{1}{2}$

Darmklemmen  
 Intestinal Clamps  
 Pincas intestinales

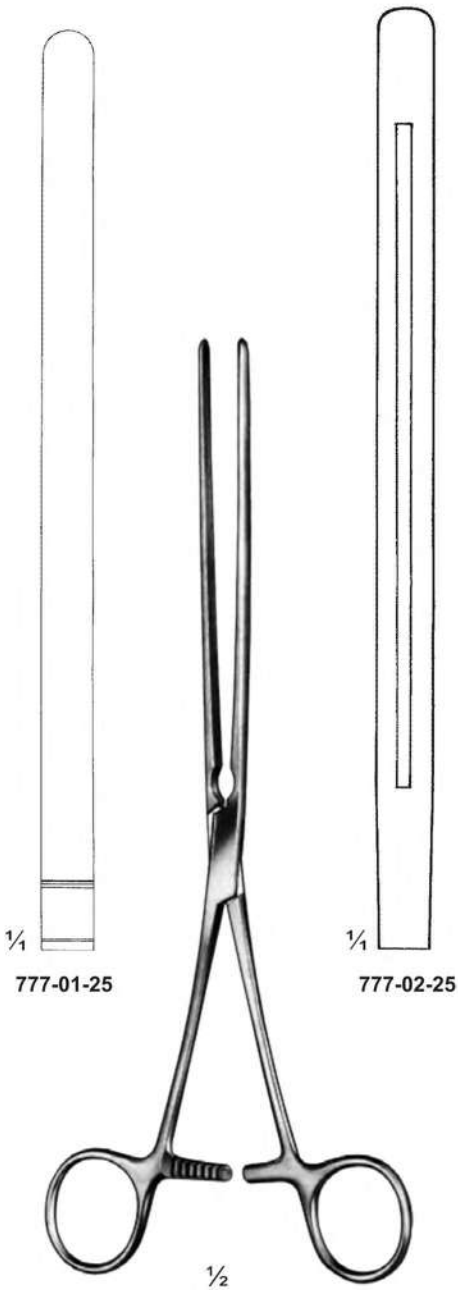

Schudder  
 777-01-25 & 777-02-25  
 25 cm / 10"

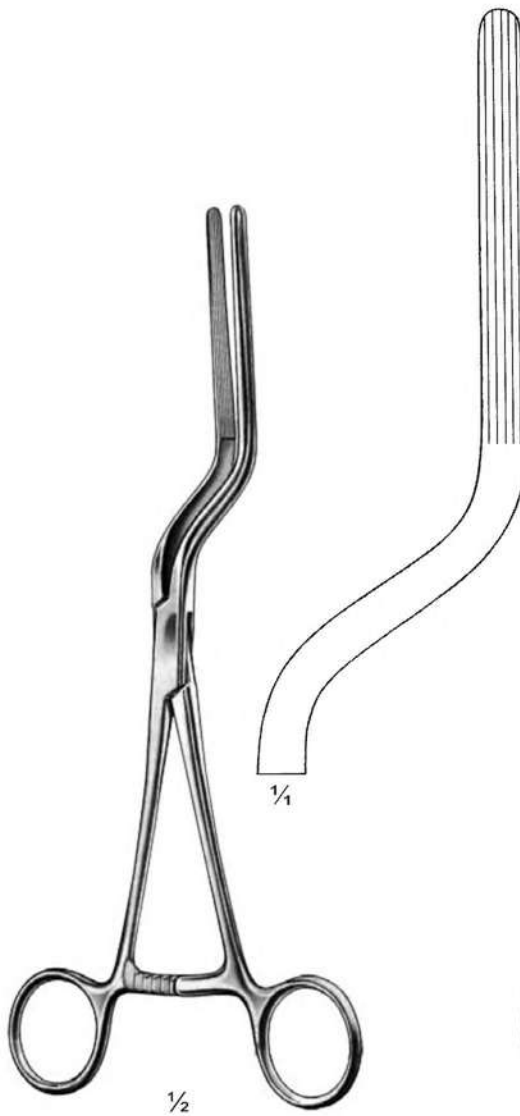

Brunner  
 777-03-24  
 24 cm / 9 1/2"

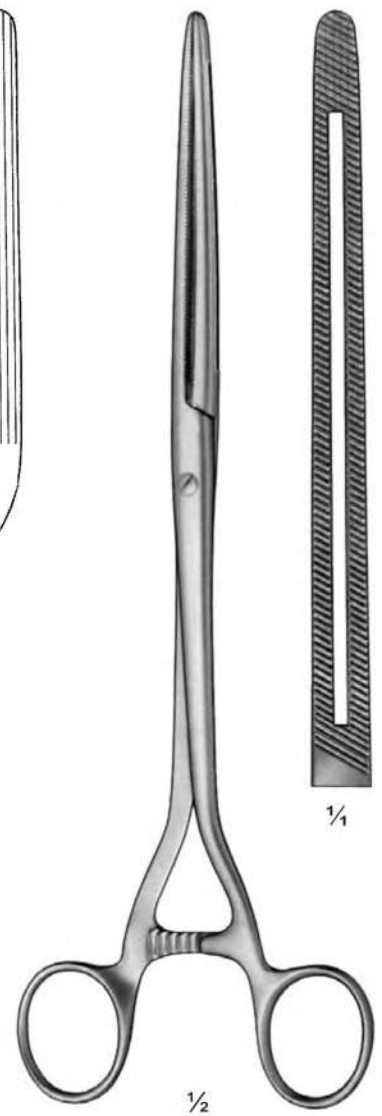

Moynihan  
 777-04-28  
 28 cm / 11"



Darmklemmen  
Intestinal Clamps  
Pincas intestinales



778-01-33

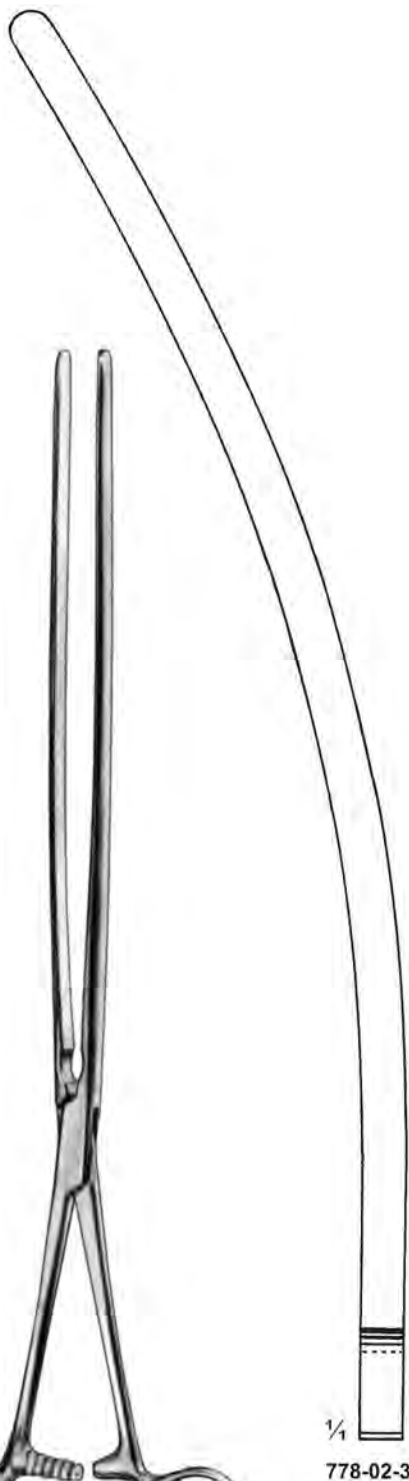

778-02-33



Schudder  
778-01-33 & 778-02-33  
33 cm / 13"

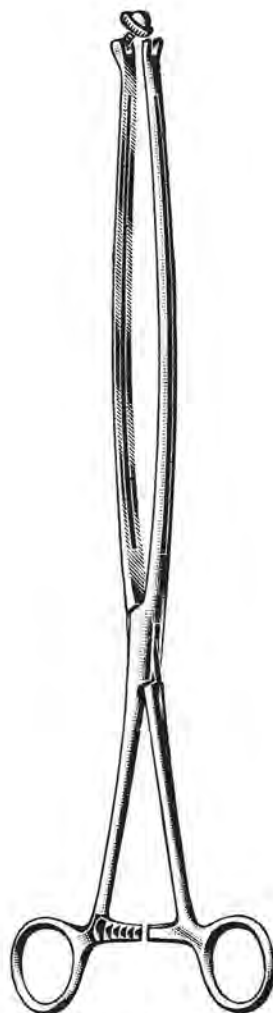

Schudder  
778-03-36  
36 cm / 14"

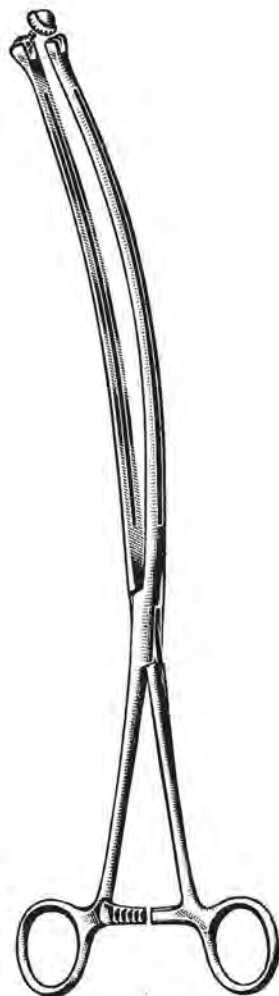

Schudder  
778-04-36  
36 cm / 14"

Darmklemmen  
 Intestinal Clamps  
 Pincas intestinales

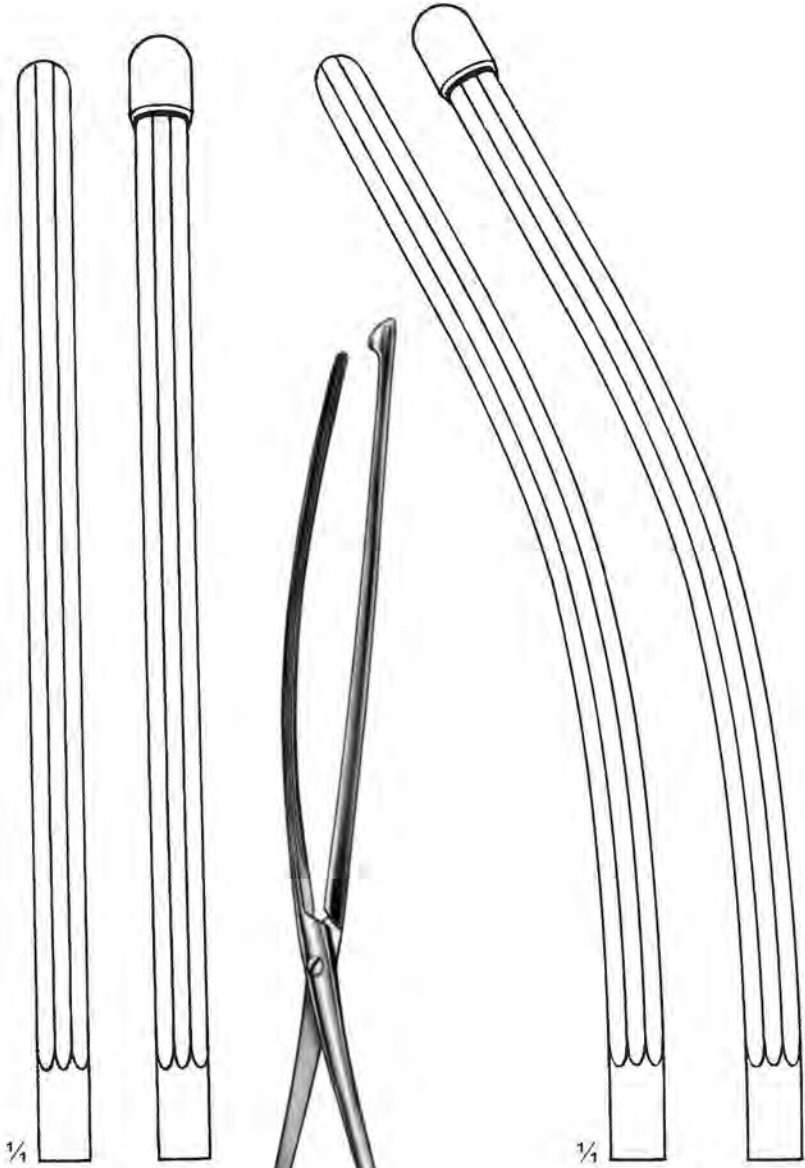

779-01-30

779-02-30



779-01-30 & 779-02-30  
 30 cm / 12"



Moynihan  
 779-03-36  
 36 cm / 14"

Moynihan  
 779-04-36  
 36 cm / 14"

**Darmklemmen  
Intestinal Clamps  
Pincés intestinales**

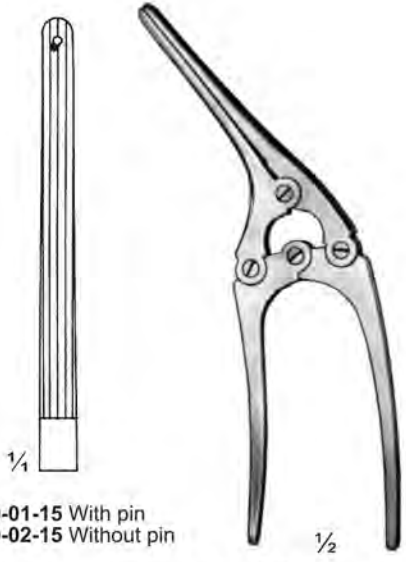

780-01-15 With pin  
780-02-15 Without pin

Payr-Baby  
780-01-15 To 780-02-15  
15 cm / 6"



Payr  
780-03-18 To 780-10-35

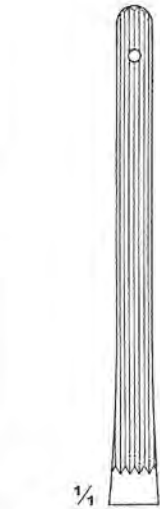

780-03-18 With pin  
780-04-18 Without pin  
18 cm / 7"

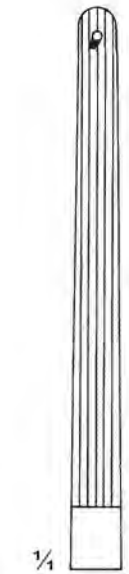

780-05-21 With pin  
780-06-21 Without pin  
21 cm / 8 1/4"

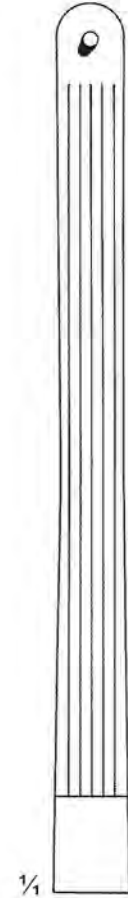

780-07-29 With pin  
780-08-29 Without pin  
29 cm / 11 1/2"

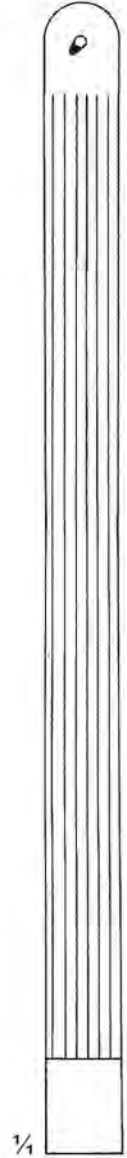

780-09-35 With pin  
780-10-35 Without pin  
35 cm / 13 3/4"

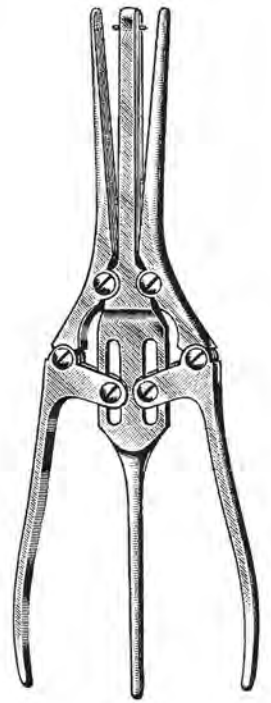

Partsch  
780-11-22  
22.5 cm / 9 1/4"

Darmklemmen  
Intestinal Clamps  
Pincas intestinales



Lane  
781-01-30  
30 cm / 12"



Lane  
781-02-30  
30 cm / 12"

Darmklemmen  
 Intestinal Clamps  
 Pincas intestinales



1/2

Baberer  
 782-01-36  
 36 cm / 14"



1/4



1/4

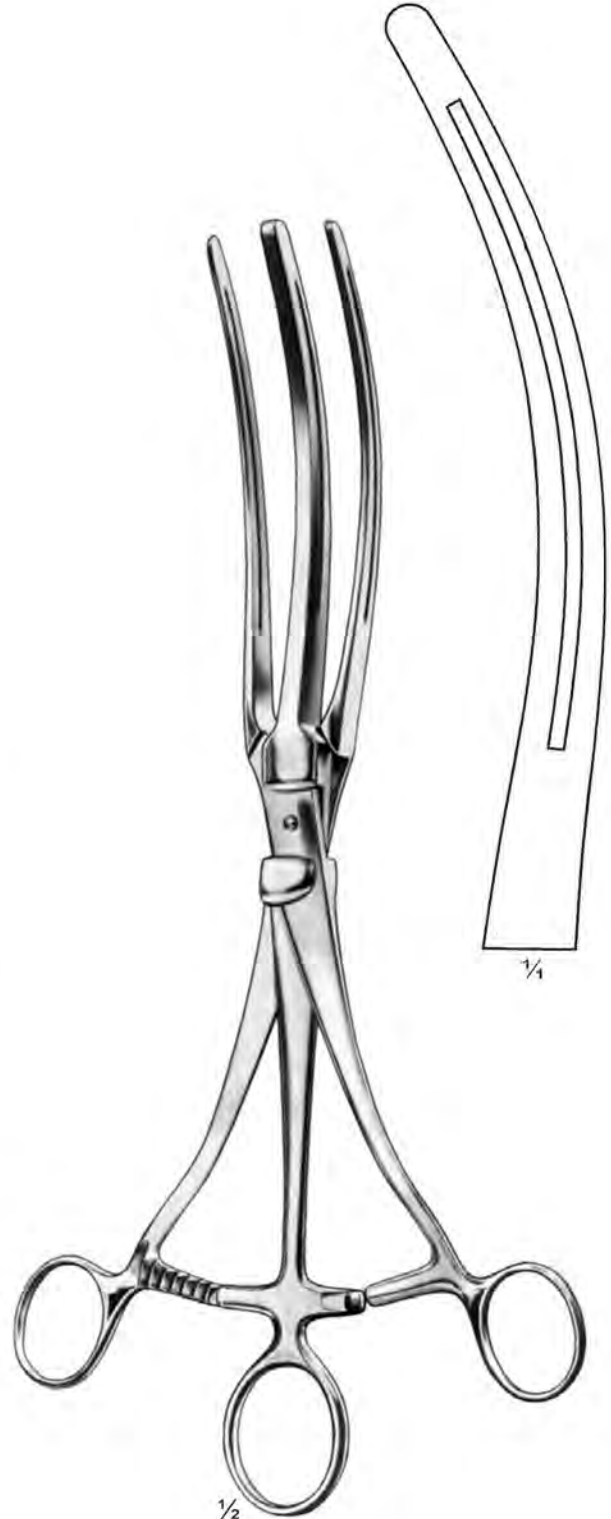

1/2

Roosevelt  
 782-02-34  
 34 cm / 13 1/2"

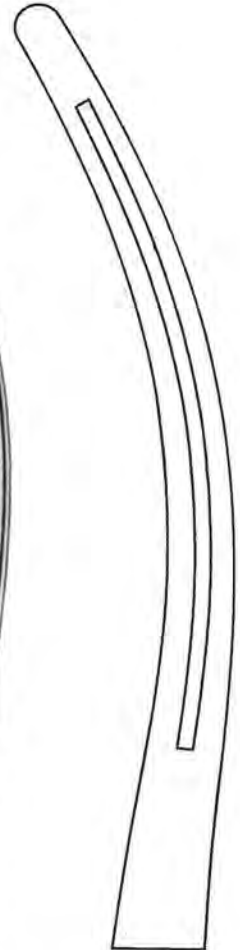

1/4

Darmklemmen  
Intestinal Clamps  
Pincés intestinales

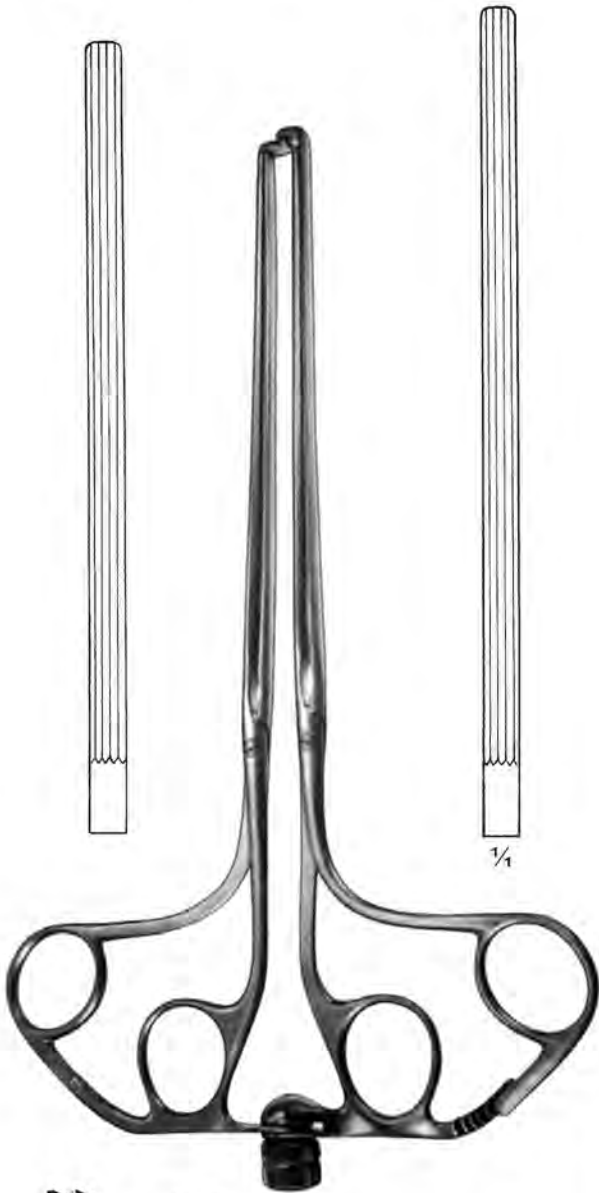

Abadie  
783-01-22 22 cm / 8 3/4"  
783-02-27 27 cm / 10 1/2"

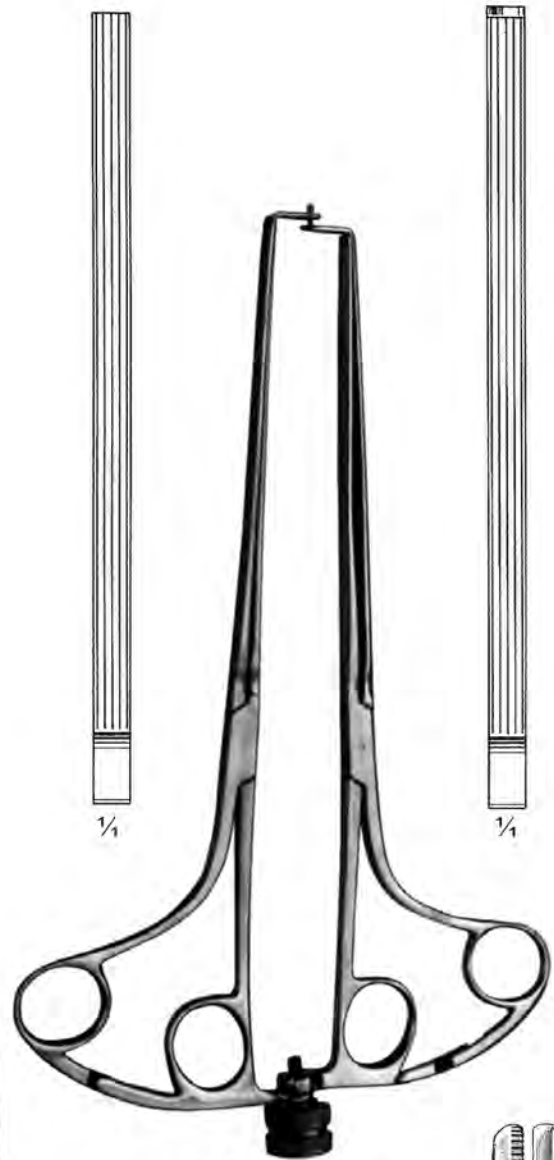

Abadie  
783-03-22 22 cm / 8 3/4"  
783-04-27 27 cm / 10 1/2"

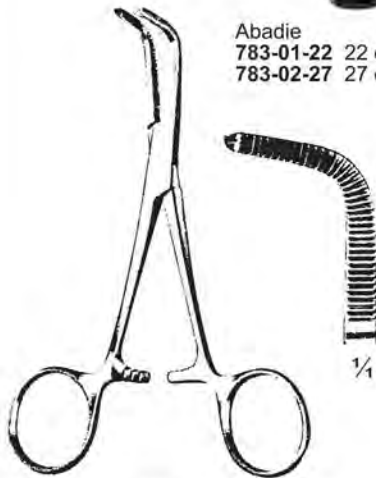

Kleinschmidt  
783-05-13  
13 cm / 5 1/8"  
Appendectomy clamp  
1 X 2 Teeth

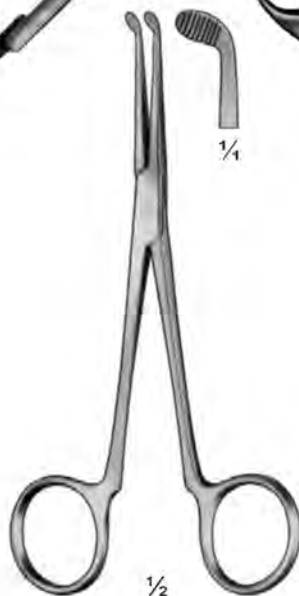

Benson  
783-06-15  
15 cm / 6"  
Pylorus spreader

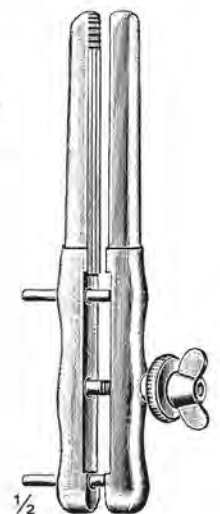

Stetten  
783-07-13  
13.5 cm / 5 1/4"



**Darmklemmen  
Intestinal Clamps  
Pincas intestinales**



De Martel-Wolfson  
784-02-50 To 784-04-100



De Martel-Wolfson  
784-05-08 8.5 cm / 3 1/4"  
784-06-23 23 cm / 9"  
Clamp holder

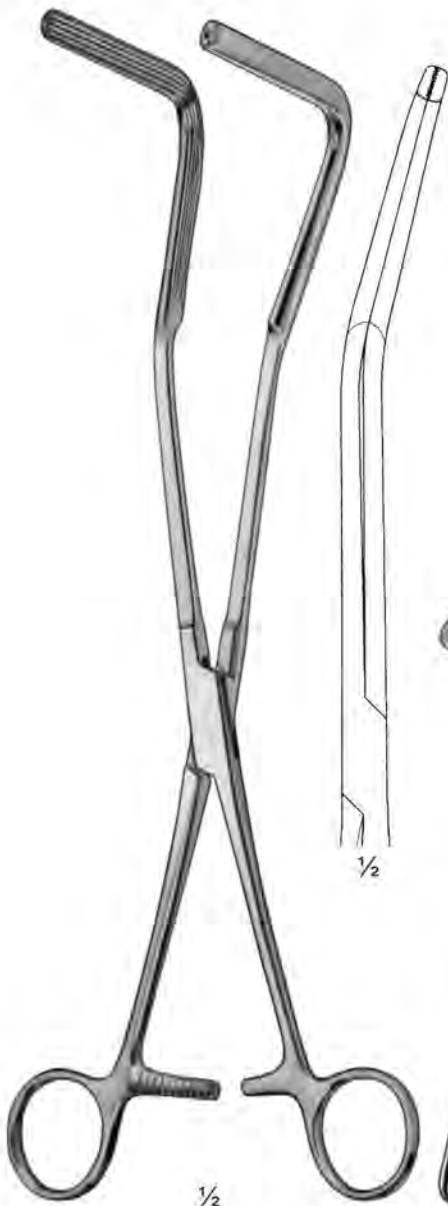

Lloyd-Davis  
784-01-31  
31.5 cm / 12 1/2"



De Martel-Wolfson  
784-07-26  
26 cm / 10 1/4"  
Clamp closing forceps



De Martel-Wolfson  
784-08-25  
25 cm / 10"  
Clamp closing forceps



Stone  
784-09-25  
25 cm / 10"

Stone-Watt  
784-10-07 7.5 cm / 3"  
784-11-10 10 cm / 4"  
With locking ferrule

Darmklemmen  
Intestinal Clamps  
Pincés intestinales



1/2

Doyen  
785-01-13 To 785-10-23



785-01-13  
13 cm / 5 1/4"



785-02-16  
16 cm / 6 1/4"



785-03-18  
18 cm / 7"

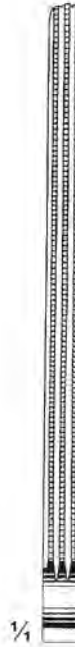

785-04-21  
21 cm / 8 1/4"

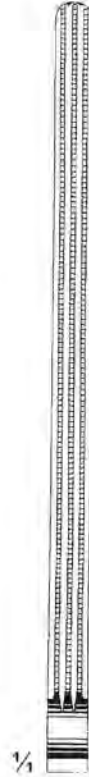

785-05-23  
23 cm / 9"



785-06-13  
13 cm / 5 1/4"

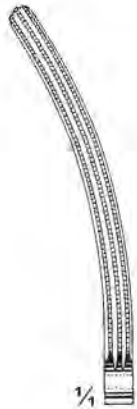

785-07-16  
16 cm / 6 1/4"

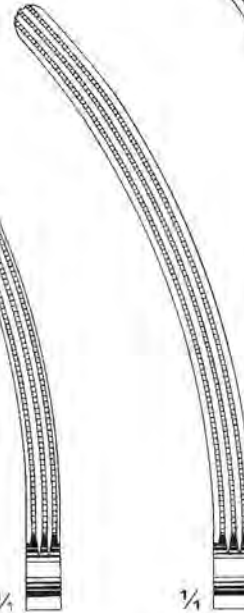

785-08-18  
18 cm / 7"

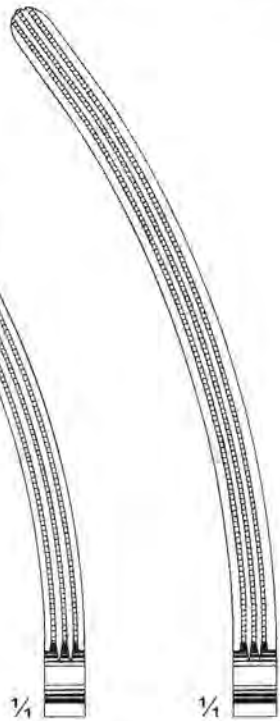

785-09-21  
21 cm / 8 1/4"



785-10-23  
23 cm / 9"

Darmklemmen  
 Intestinal Clamps  
 Pincas intestinales

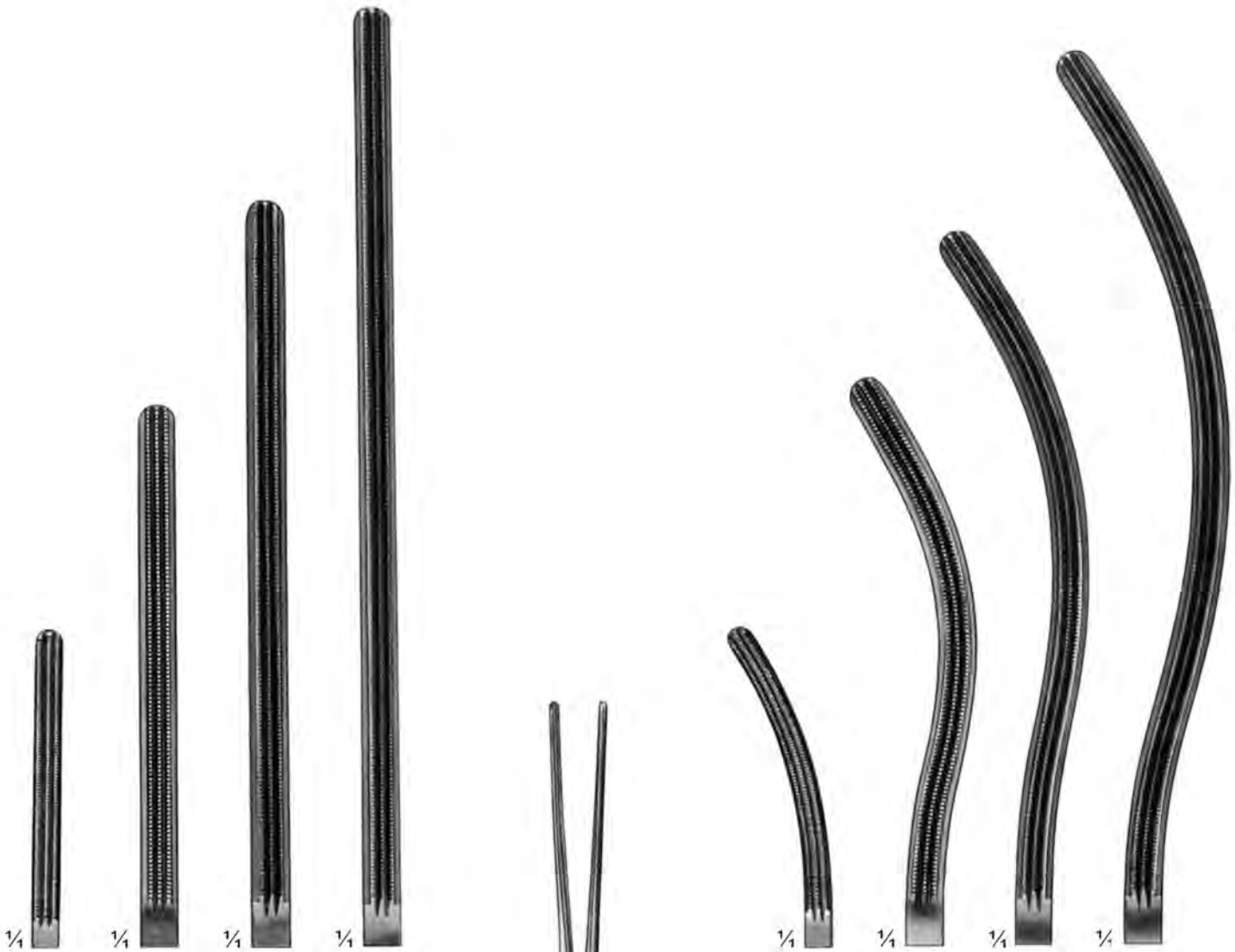

$\frac{1}{4}$	$\frac{1}{4}$	$\frac{1}{4}$	$\frac{1}{4}$
<b>786-01-13</b> 13 cm / 5 $\frac{1}{8}$ "	<b>786-02-22</b> 22 cm / 8 $\frac{3}{4}$ "	<b>786-03-25</b> 25 cm / 10"	<b>786-04-28</b> 28 cm / 11"

$\frac{1}{4}$	$\frac{1}{4}$	$\frac{1}{4}$	$\frac{1}{4}$
<b>786-05-13</b> 13 cm / 5 $\frac{1}{8}$ "	<b>786-06-22</b> 22 cm / 8 $\frac{3}{4}$ "	<b>786-07-25</b> 25 cm / 10"	<b>786-08-28</b> 28 cm / 11"



$\frac{1}{2}$   
 Kocher  
 786-01-13 To 786-08-28



Darmklemmen  
Intestinal Clamps  
Pincas intestinales

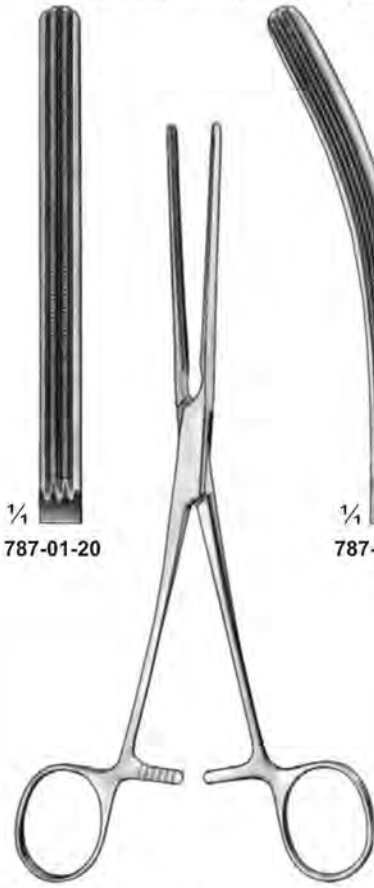

$\frac{1}{4}$   
787-01-20

$\frac{1}{4}$   
787-02-20

Hartmann  
787-01-20 & 787-02-20  
20 cm / 8"

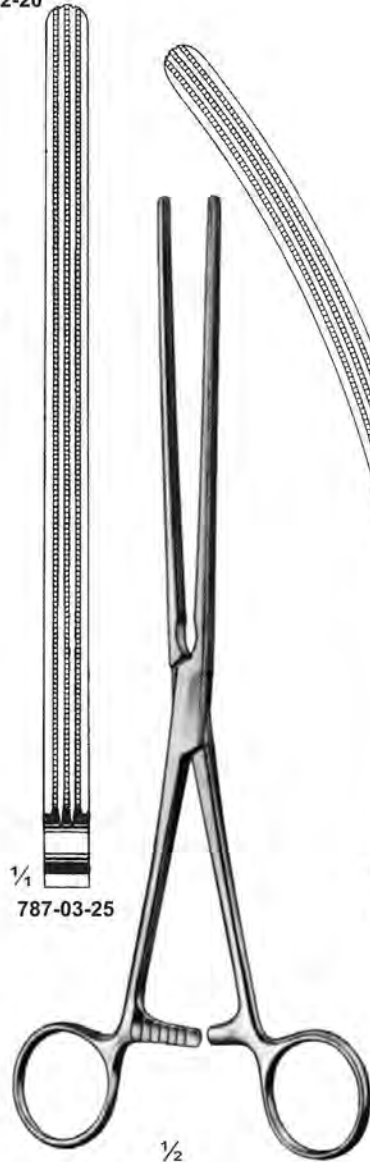

$\frac{1}{4}$   
787-03-25

$\frac{1}{4}$   
787-04-25

$\frac{1}{2}$   
Mayo-Robson  
787-03-25 & 787-04-25  
25 cm / 10"



$\frac{1}{4}$   
787-05-33

$\frac{1}{4}$   
787-06-33

$\frac{1}{2}$   
Scudder  
787-05-33 & 787-06-33  
33 cm / 13"

Darmklemmen  
 Intestinal Clamps  
 Pincas intestinales

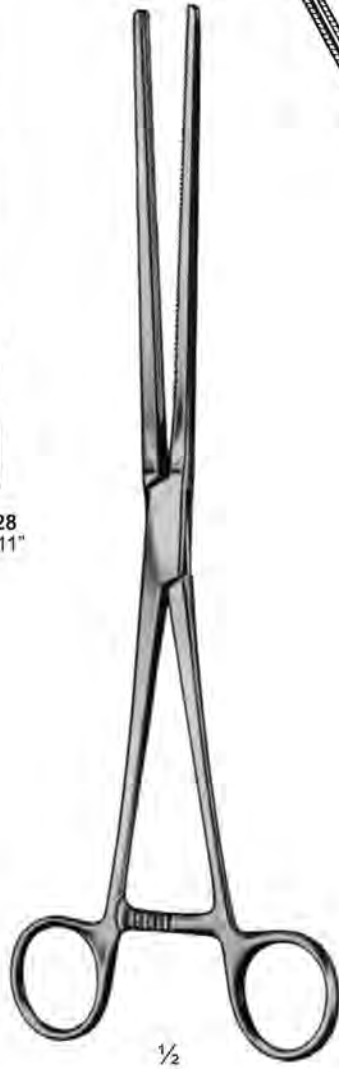
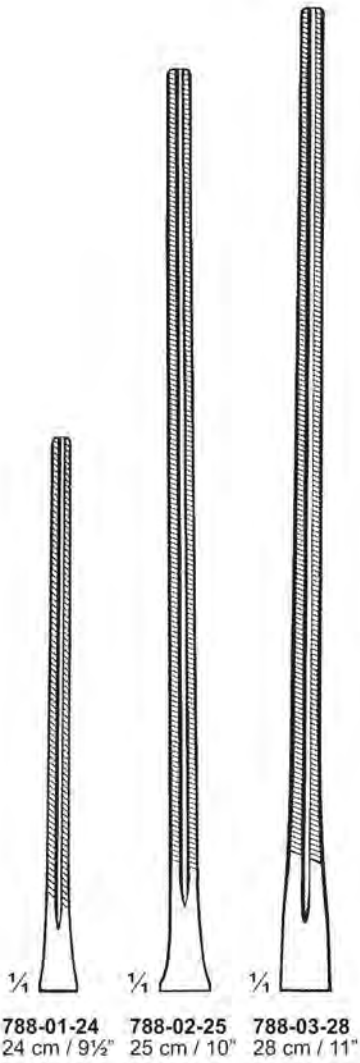

Glassman  
 788-01-24 To 788-06-28

Darmklemmen  
 Intestinal Clamps  
 Pincas intestinales



$\frac{1}{2}$   
 Haberer  
 789-01-36  
 36 cm / 14 $\frac{1}{4}$ "



$\frac{1}{4}$



$\frac{1}{4}$



$\frac{1}{4}$

789-02-25  
 25 cm / 10"

$\frac{1}{4}$

789-03-26  
 26.5 cm / 10 $\frac{1}{2}$ "

$\frac{1}{4}$

789-04-27  
 27.5 cm / 10 $\frac{3}{4}$ "

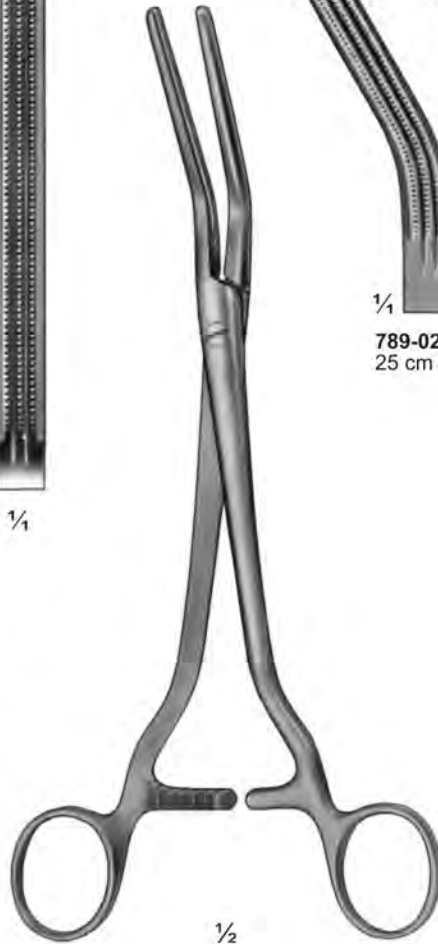

$\frac{1}{2}$

Dick  
 789-02-25 To 789-04-27



Anastomosenklemmen  
Anastomosis Clamps  
Pinces-clamps à anastomose

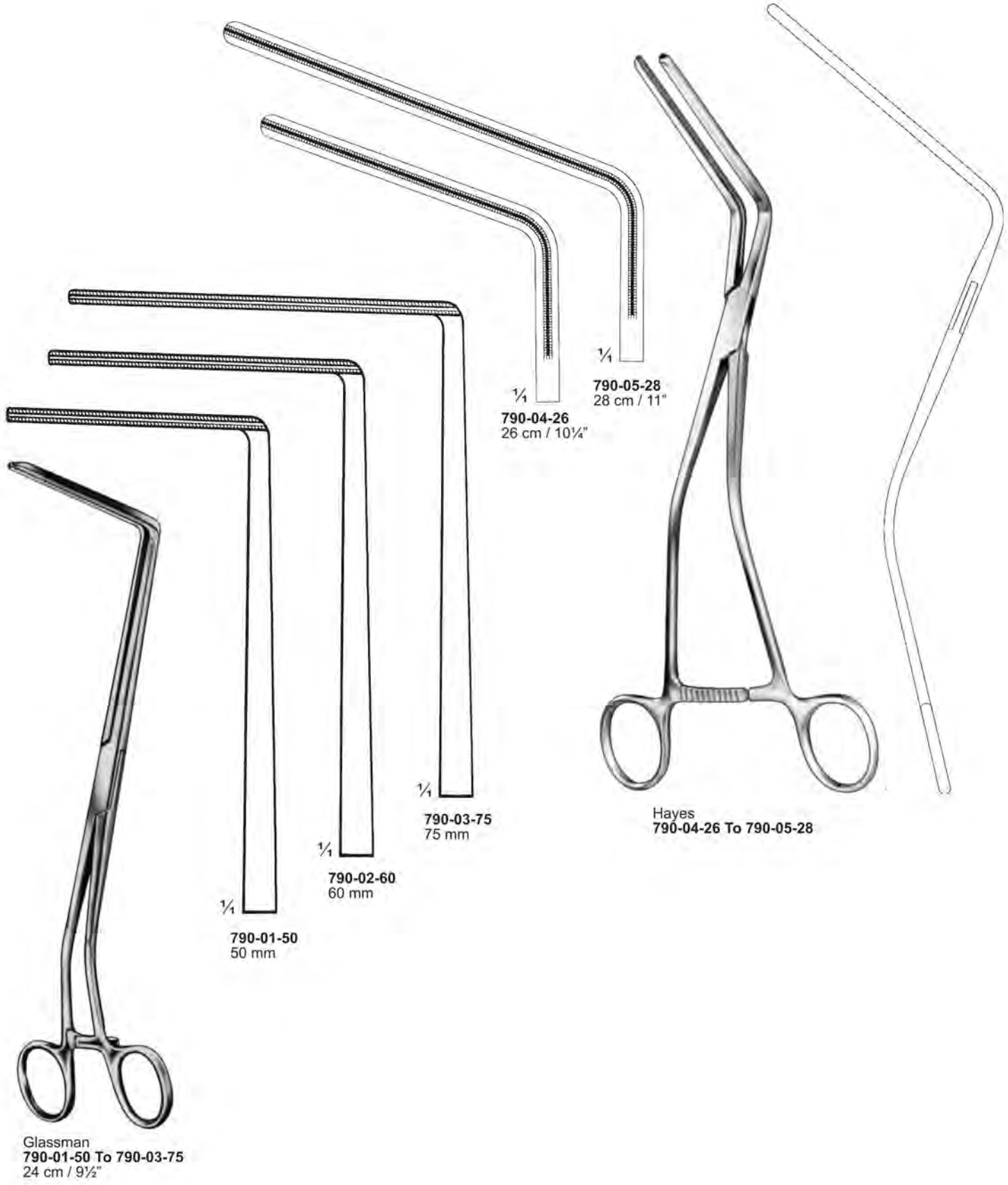

*Anastomosenklemmen  
Anastomosis Clamps  
Pinces-clamps à anastomose*



Kersting  
791-01-27  
27 cm / 10½"

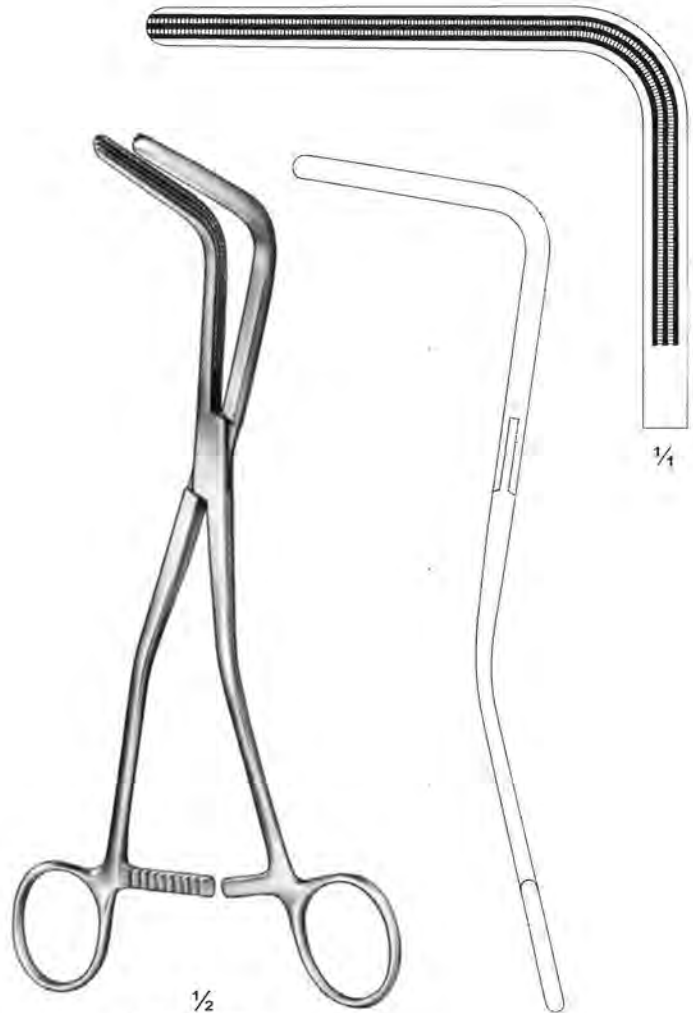

1/2  
Veidenheimer  
791-02-23  
23 cm / 9"



*Anastomosenklemmen  
Anastomosis Clamps  
Pinces-clamps à anastomose*



¼

½

Resano  
792-01-27  
27 cm / 10½"



¼

½

Fehland  
792-02-24  
24 cm / 9½"

**Anastomosenklemmen  
Anastomosis Clamps  
Pinces-clamps à anastomose**

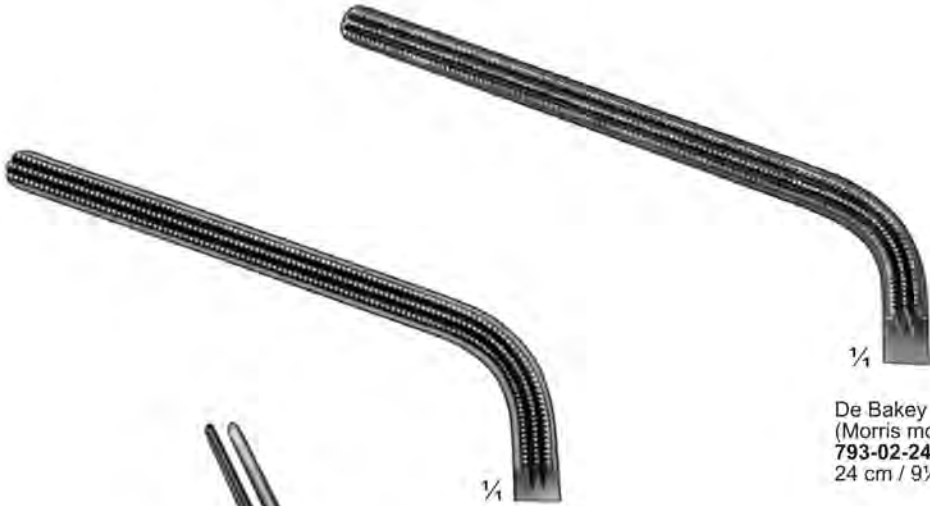

Morris  
793-01-18  
18 cm / 7"

De Bakey  
(Morris modif.)  
793-02-24  
24 cm / 9½"



793-01-18 & 793-02-24

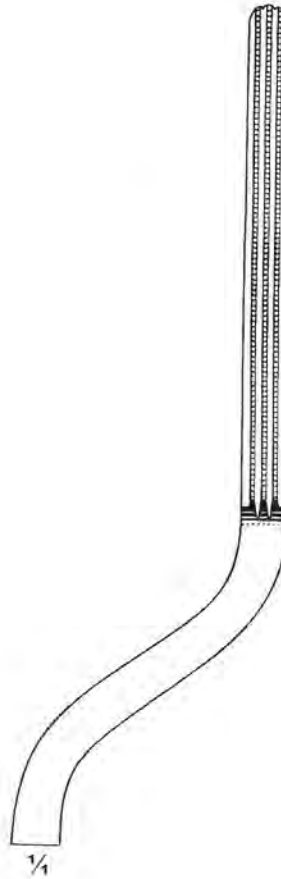

1/2  
Brunner  
793-03-24  
24 cm / 9½"

**Anastomosenklemmen  
Anastomosis Clamps  
Pinces-clamps à anastomose**



**794-01-07**  
7 cm / 2¾"



**794-02-08**  
8.5 cm / 3¼"



**Kersting**  
**794-01-07 & 794-02-08**



**Becker**  
**794-03-33**  
33.5 cm / 13¼"  
Oesophagus  
dissector  
Small



**Becker**  
**794-04-33**  
33.5 cm / 13¼"  
Oesophagus  
dissector  
Medium

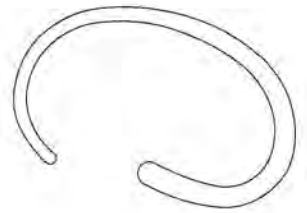

**Becker**  
**794-05-33**  
33.5 cm / 13¼"  
Oesophagus  
dissector  
Large

**Mastdarmspekula  
Rectal Specula  
Spéculums rectaux**



25 X 115 mm

Czerny  
795-01-22  
22 cm / 8¾"



12/20 X 70 mm

Ricord  
795-02-16  
16 cm / 6¼"



15/30 X 70 mm

½  
Roschke  
795-03-18  
18 cm / 7"



90 X 15 mm

½  
Mathieu  
795-04-19  
19.5 cm / 7¾"



100 X 10 mm

½  
Cook  
795-05-19  
19 cm / 7½"

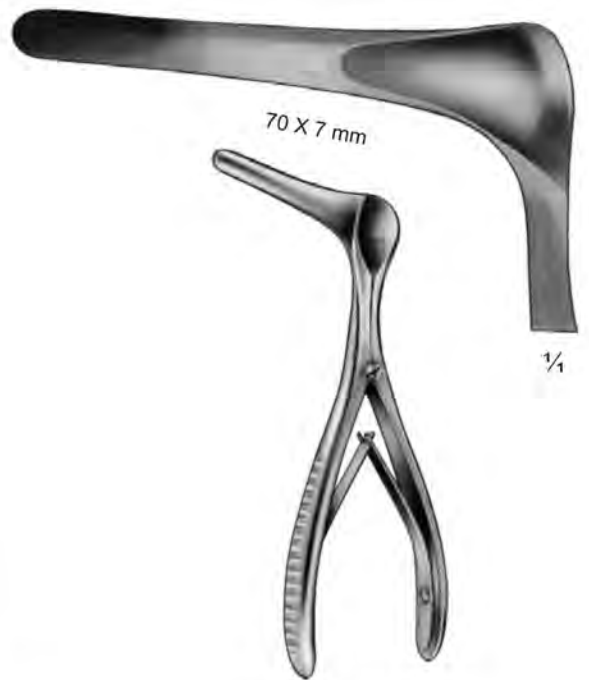

70 X 7 mm

¼  
Killian  
795-06-14  
14.5 cm / 5¾"  
For children



**Mastdarmspekula  
Rectal Specula  
Spéculums rectaux**



Schulze-Bergmann  
796-01-19 To 796-04-24



20 X 60 mm

1/2  
796-01-19  
796-05-19  
19 cm / 7 1/2"  
For children

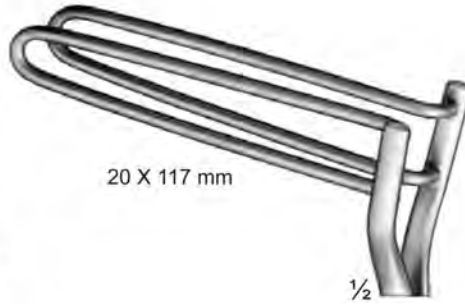

20 X 117 mm

1/2  
796-03-23  
796-07-23  
23.5 cm / 9 1/4"  
For adult



20 X 83 mm

1/2  
796-02-23  
796-06-23  
23.5 cm / 9 1/4"  
For adult

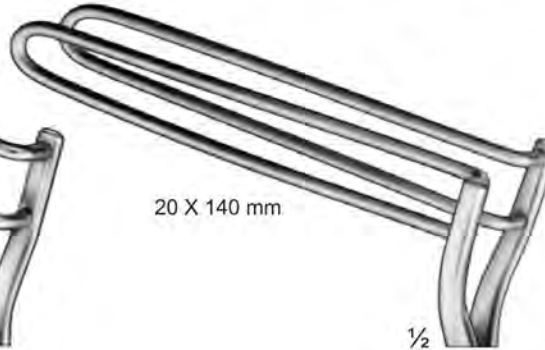

20 X 140 mm

1/2  
796-04-24  
796-08-24  
24.5 cm / 9 3/4"  
For adult



Sims  
796-05-19 To 796-08-24



17 X 77 mm

Sims  
796-09-16  
16 cm / 6 1/4"



17 X 77 mm

Sims  
796-10-16  
16 cm / 6 1/4"

Mastdarmspekula  
Rectal Specula  
Spéculums rectaux



Pratt  
797-01-20  
20 cm / 8"



Barr  
797-02-17  
17 cm / 6 3/4"



Barr  
797-03-13  
13.5 cm / 5 1/4"  
With 2 pairs of blades

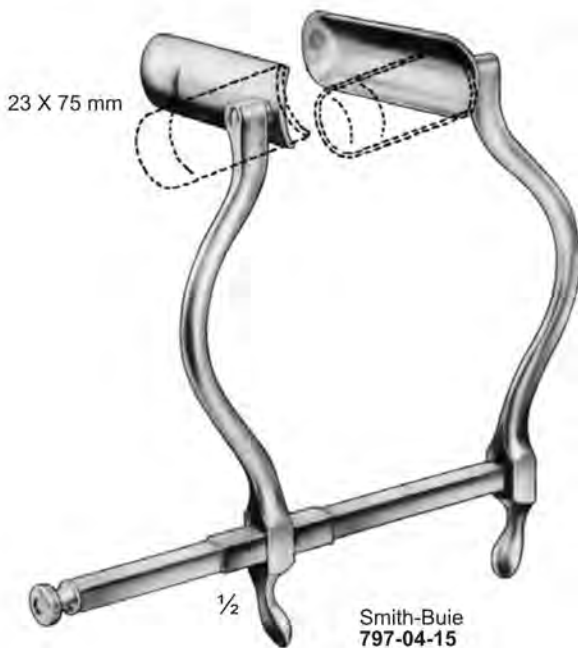

Smith-Buie  
797-04-15  
15 cm / 6"



Park  
797-05-16  
16 cm / 6 1/4"



Brinkerhoff  
797-06-90 Ø 13/25 X 90 mm  
797-07-100 Ø 15/25 X 100 mm  
797-08-115 Ø 19/32 X 115 mm

Mastdarmspekula  
Rectal Specula  
Spéculums rectaux



$\frac{1}{2}$   
Ives-Fransler  
798-01-14  
14.5 cm / 5 $\frac{3}{4}$ "

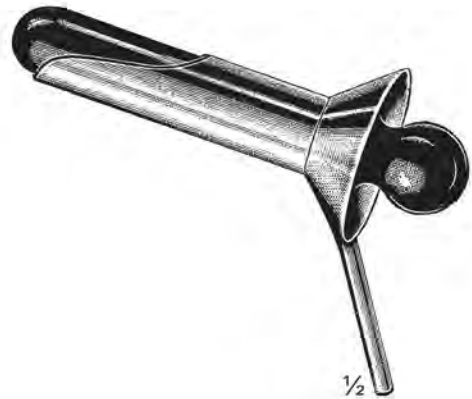

$\frac{1}{2}$   
Ives-Fransler  
798-02-00



Hirschmann  
798-03-16 Ø 16 X 60 mm  
798-04-19 Ø 19 X 70 mm  
798-05-22 Ø 22 X 90 mm



$\frac{1}{2}$   
Bensaude  
798-06-17 Ø 17 mm  
798-07-20 Ø 20 mm  
798-08-23 Ø 23 mm  
19 cm / 7 $\frac{1}{2}$



$\frac{1}{2}$   
Newman  
798-09-16 Ø 16 X 63 mm  
798-10-19 Ø 19 X 63 mm  
798-11-23 Ø 23 X 63 mm

**Mastdarmspekula  
Rectal Specula  
Spéculum rectaux**

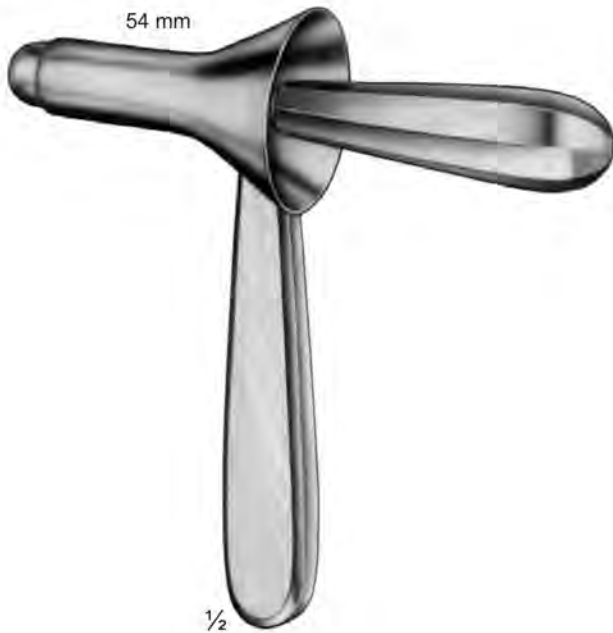

Kelly  
799-01-21  
16 cm / 6¼"  
Ø 21 X 54 mm



Kelly  
799-02-22 Ø 22 X 50 mm  
799-03-22 Ø 22 X 100 mm  
799-04-22 Ø 22 X 140 mm

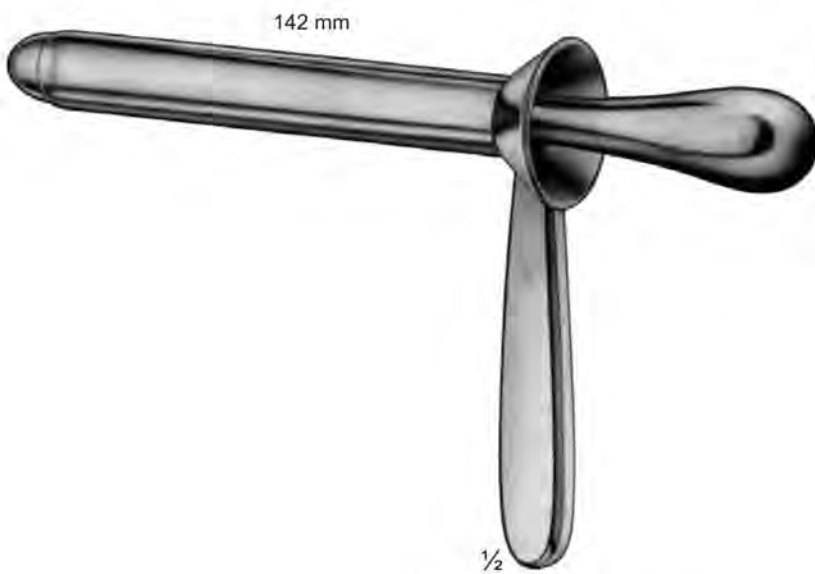

Kelly  
799-05-27 Ø 27 X 142 mm  
799-06-27 Ø 27 X 205 mm  
14 cm / 5½"

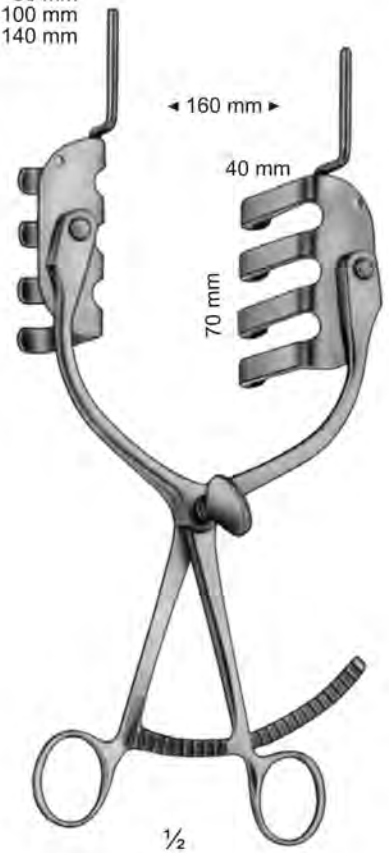

St. Marks,  
Modif. Girona  
799-07-00  
Perineal retractor with towel  
pegs fitted to swivel rake blades



**Hämorrhoidenfasszange**  
**Hemorrhoidal Grasping Forceps**  
**Pince pour hémorroïdes**



Lloyd-Davis (St. Marks)  
**800-01-60** 60 X 130 mm  
**800-02-60** 60 X 180 mm  
 33 cm / 13"



Lloyd-Davis (St. Marks)  
**800-03-60** 60 X 130 mm  
**800-04-60** 60 X 180 mm  
 30 cm / 12"



$\frac{1}{2}$   
 Mc Givney  
**800-05-18**  
 18.5 cm / 7 $\frac{1}{4}$ "

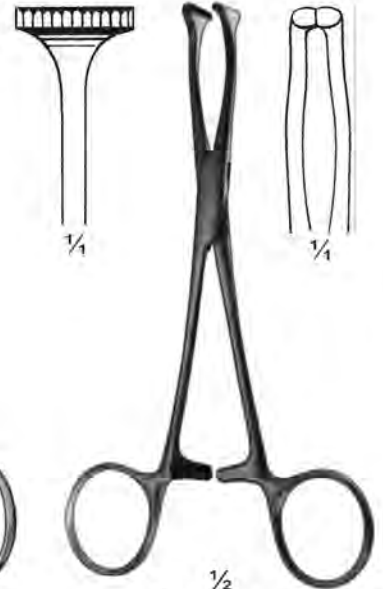

$\frac{1}{2}$   
 Pratt-Smith  
**800-06-16**  
 16 cm / 6 $\frac{1}{4}$ "

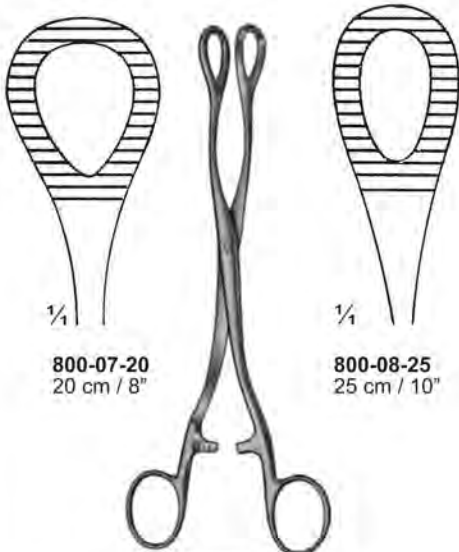

$\frac{1}{4}$   
**800-07-20**  
 20 cm / 8"

$\frac{1}{4}$   
**800-08-25**  
 25 cm / 10"

Heywood-Smith  
**800-07-20 & 800-08-25**

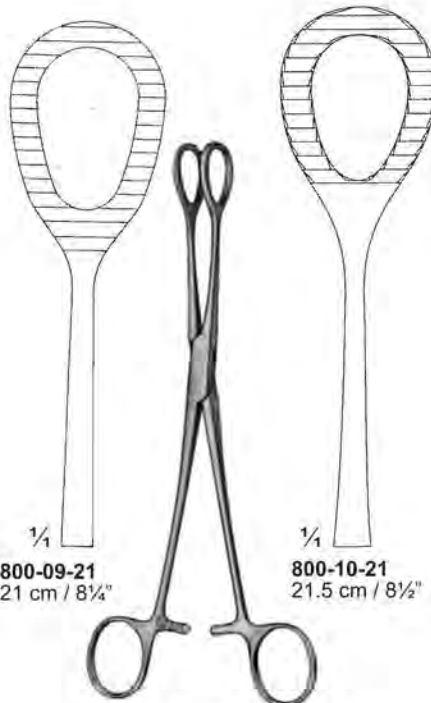

$\frac{1}{4}$   
**800-09-21**  
 21 cm / 8 $\frac{1}{4}$ "

$\frac{1}{4}$   
**800-10-21**  
 21.5 cm / 8 $\frac{1}{2}$ "

Heywood-Smith modif.  
**800-09-21 & 800-10-21**

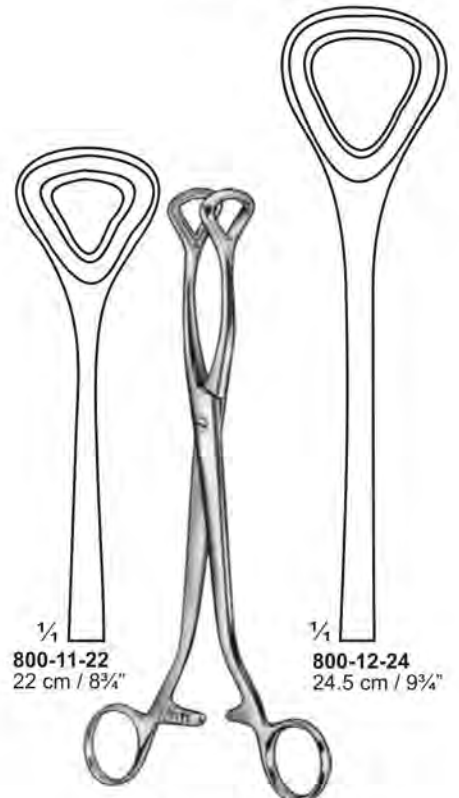

$\frac{1}{4}$   
**800-11-22**  
 22 cm / 8 $\frac{3}{4}$ "

$\frac{1}{4}$   
**800-12-24**  
 24.5 cm / 9 $\frac{3}{4}$ "

Luer  
**800-11-22 & 800-12-24**

**Hämorrhoidenfasszange**  
**Hemorrhoidal Grasping Forceps**  
**Pince pour hémorroïdes**



$\frac{1}{2}$   
**Fergusson**  
**801-01-20 & 801-02-20**  
 20 cm / 8"

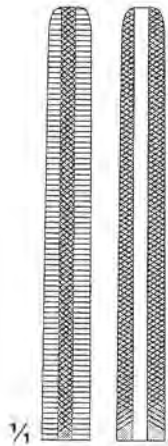

$\frac{1}{4}$   
**801-01-20**

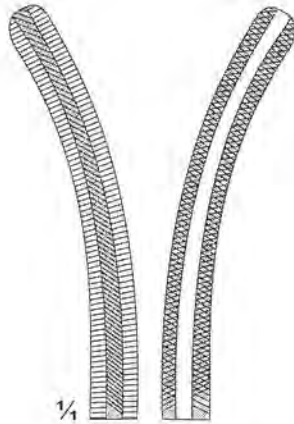

$\frac{1}{4}$   
**801-02-20**

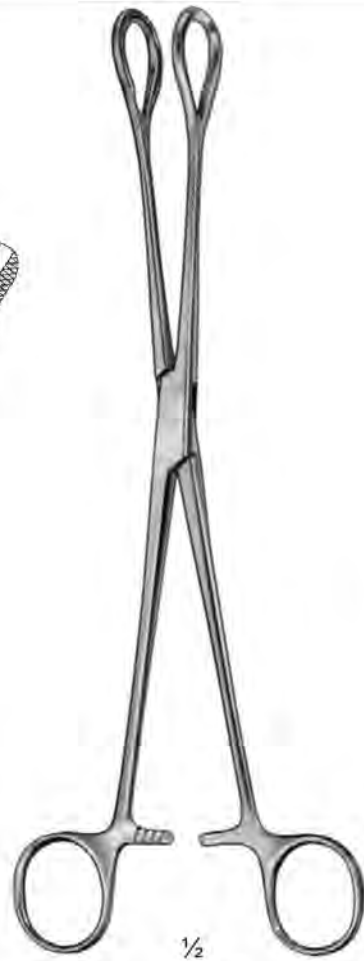

$\frac{1}{2}$   
**801-03-25 & 801-04-26**



$\frac{1}{4}$   
**801-03-25**  
 25 cm / 10"



$\frac{1}{4}$   
**801-04-26**  
 26 cm / 10 1/4"

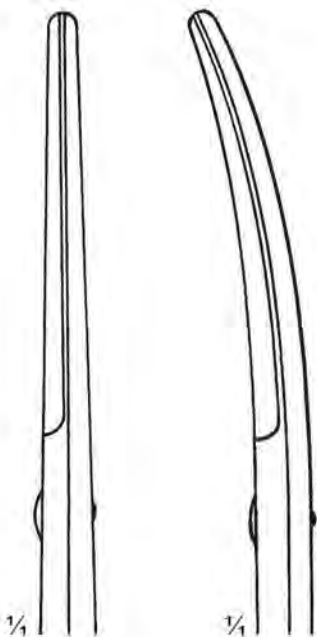

$\frac{1}{4}$  **801-05-25** 25 cm / 10"  $\frac{1}{4}$  **801-07-25**  
 $\frac{1}{4}$  **801-06-30** 30 cm / 12"  $\frac{1}{4}$  **801-08-30**



$\frac{1}{2}$   
**Lloyd-Davies (Goligher's)**  
**801-05-25 To 801-08-30**

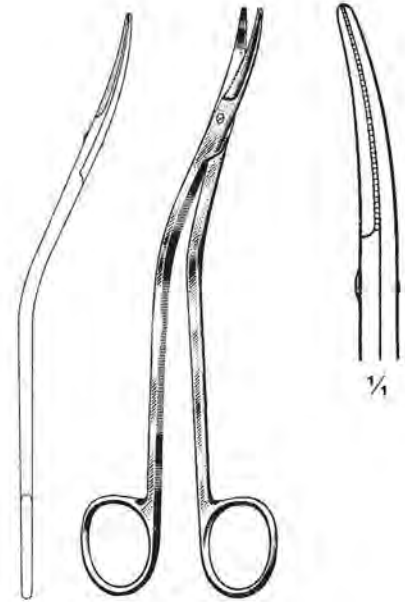

$\frac{1}{4}$   
**Miller**  
**801-09-17**  
 17 cm / 6 3/4"

Darmscheren  
Enterotomy Scissors  
Ciseaux-entérotomes

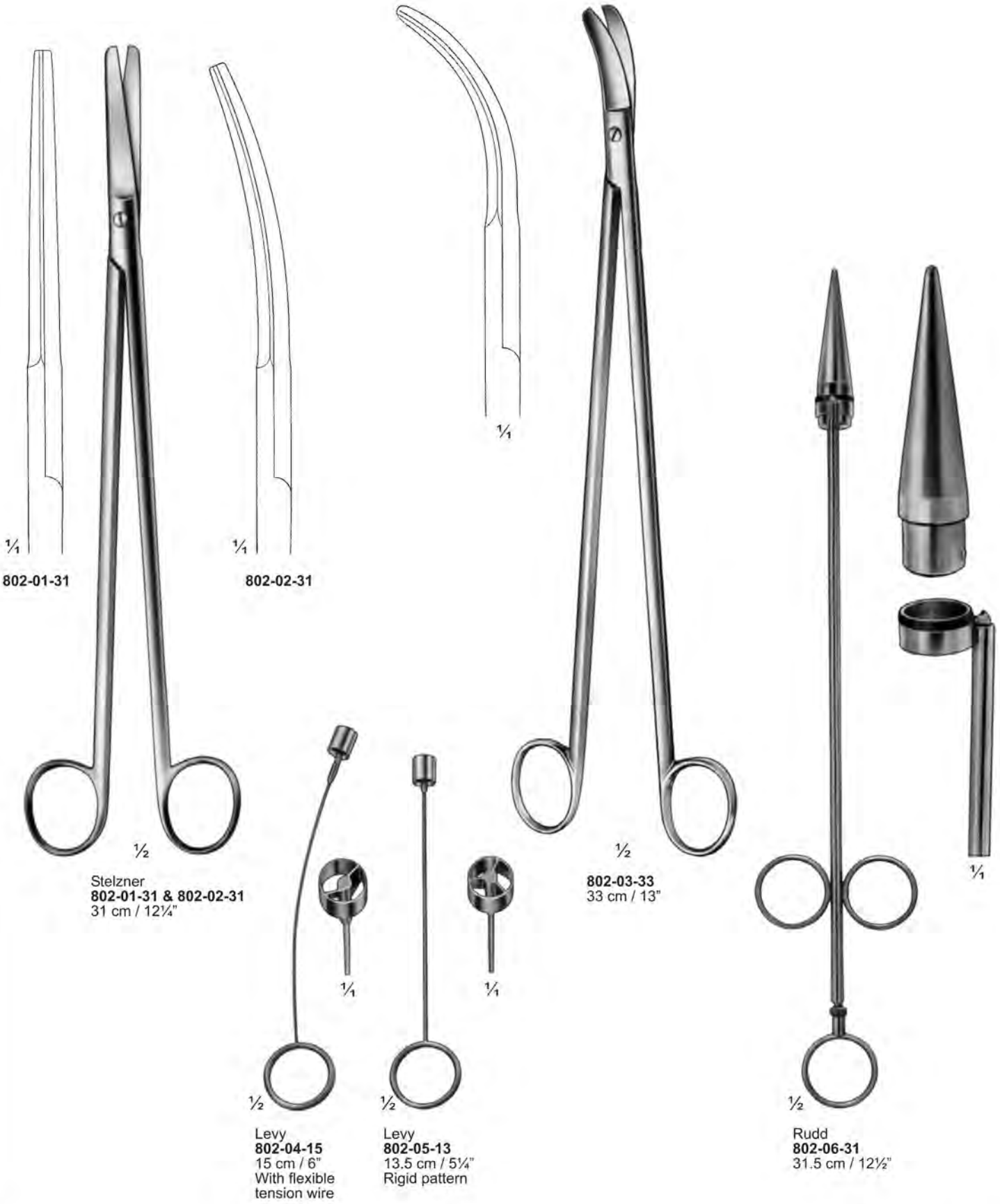

802-01-31

802-02-31

Stelzner  
802-01-31 & 802-02-31  
31 cm / 12 1/4"

802-03-33  
33 cm / 13"

Levy  
802-04-15  
15 cm / 6"  
With flexible  
tension wire

Levy  
802-05-13  
13.5 cm / 5 1/4"  
Rigid pattern

Rudd  
802-06-31  
31.5 cm / 12 1/2"

**Darmscheren, Hämorrhoidal-Ligator  
Enterotomy Scissors, Hemorrhoidal Ligator  
Ciseaux-entérotomes, Ligateur pour hémorroïdes**



McGivney modif.  
803-01-00

803-02-00 Lockhart-Mummery  
803-03-16 To 803-06-16  
16.5 cm / 6 1/2"

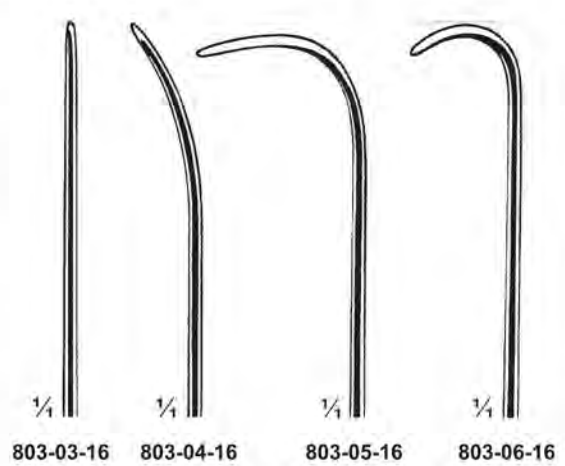

1/4 803-03-16    1/4 803-04-16    1/4 803-05-16    1/4 803-06-16



1/2 803-07-20  
20 cm / 8"



1/2 803-08-19  
19 cm / 7 1/2"



803-09-19  
19 cm / 7 1/2"  
Malleable



Pratt  
803-10-20  
20 cm / 8"



1/2 Buie  
803-11-16  
16 cm / 6 1/4"



Pratt  
803-12-24 To 803-15-24  
24 cm / 9 1/2"

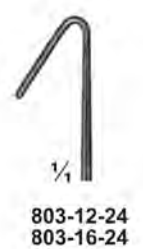

1/4 803-12-24  
803-16-24

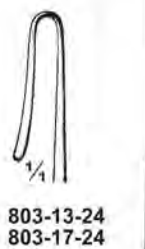

1/4 803-13-24  
803-17-24



1/4 803-14-24  
803-18-24



1/4 803-15-24  
803-19-24



1/2 803-16-24 To 803-19-24  
24 cm / 9 1/2"



**Rektum-Biopsiefasszangen**  
**Rectal Biopsy Forceps**  
**Pinces pour biopsie rectale**



Yeoman  
804-01-28 To 804-12-42

<p>Shaft length  <b>804-01-28</b> 28 cm / 11"  <b>804-02-35</b> 35 cm / 13<sup>3</sup>/<sub>4</sub>"  <b>804-03-42</b> 42 cm / 16<sup>1</sup>/<sub>2</sub>"</p>	<p>Shaft length  <b>804-04-28</b> 28 cm / 11"  <b>804-05-35</b> 35 cm / 13<sup>3</sup>/<sub>4</sub>"  <b>804-06-42</b> 42 cm / 16<sup>1</sup>/<sub>2</sub>"</p>	<p>Shaft length  <b>804-07-28</b> 28 cm / 11"  <b>804-08-35</b> 35 cm / 13<sup>3</sup>/<sub>4</sub>"  <b>804-09-42</b> 42 cm / 16<sup>1</sup>/<sub>2</sub>"</p>	<p>Shaft length  <b>804-10-28</b> 28 cm / 11"  <b>804-11-35</b> 35 cm / 13<sup>3</sup>/<sub>4</sub>"  <b>804-12-42</b> 42 cm / 16<sup>1</sup>/<sub>2</sub>"</p>

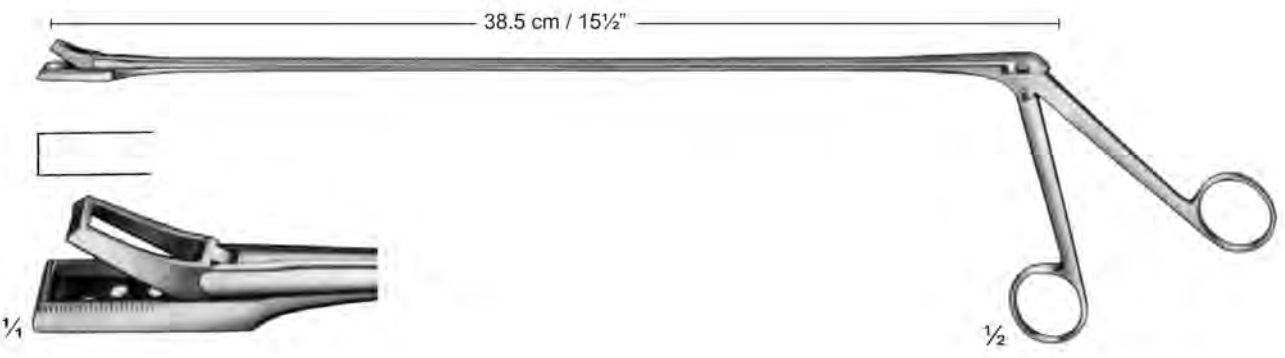

**804-13-38**  
Shaft length 38.5 cm / 15<sup>1</sup>/<sub>2</sub>"

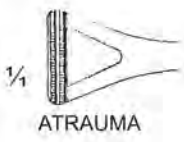
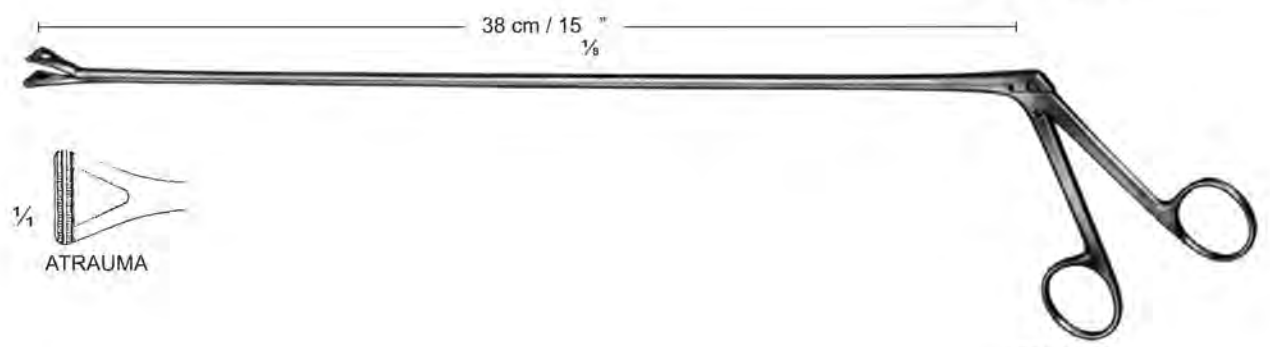

**804-14-38**  
Shaft length 38 cm / 15<sup>1</sup>/<sub>8</sub>"

**Rektum-Biopsiefasszangen**  
**Rectal Biopsy Forceps**  
**Pinces pour biopsie rectale**

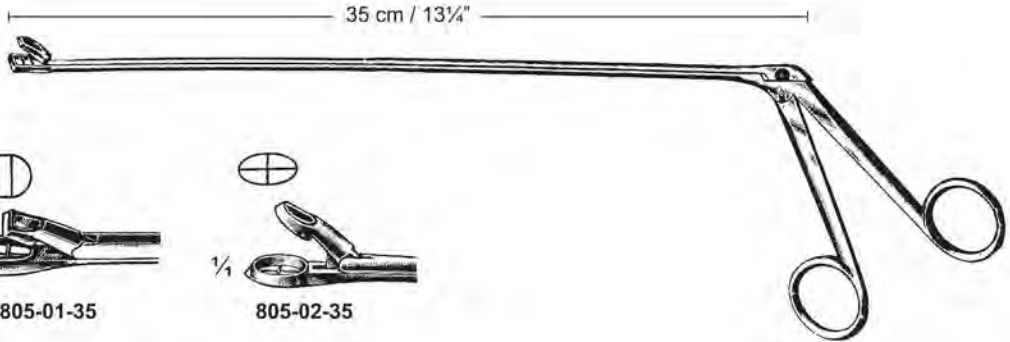

Jackson  
**805-01-35 & 805-02-35**  
 Shaft length 35 cm / 13 1/4"

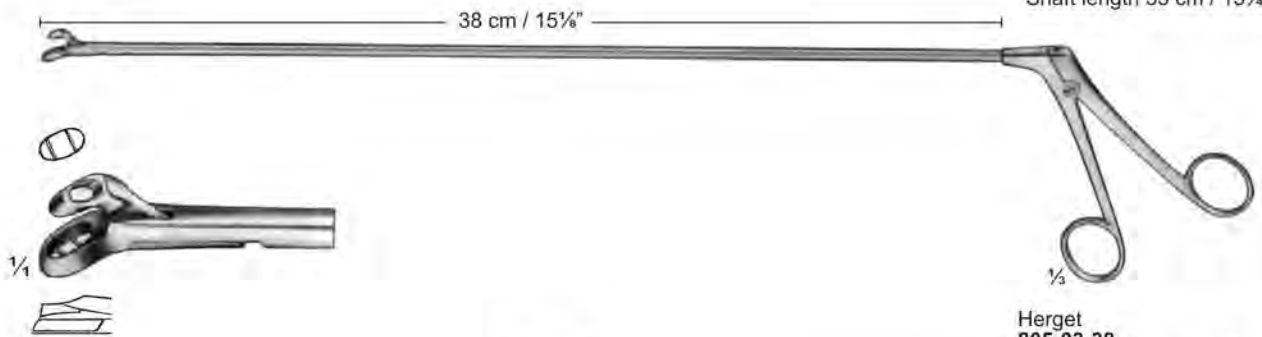

Herget  
**805-03-38**  
 Shaft length 38 cm / 15 1/8"

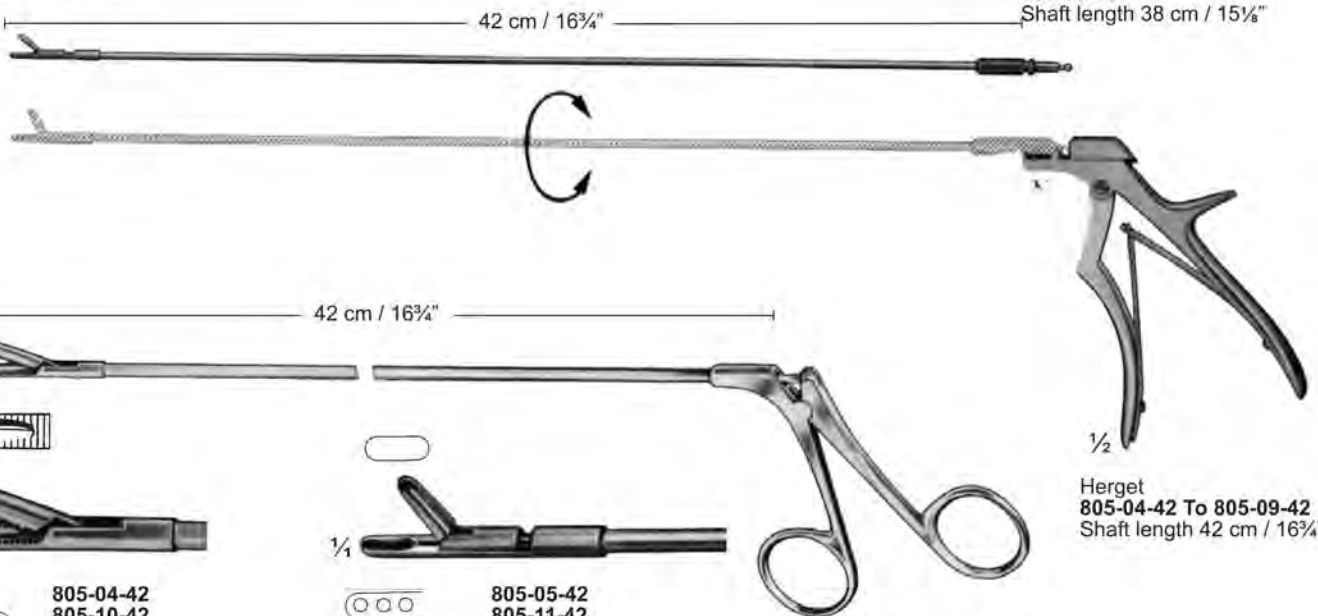

Herget  
**805-04-42 To 805-09-42**  
 Shaft length 42 cm / 16 1/4"

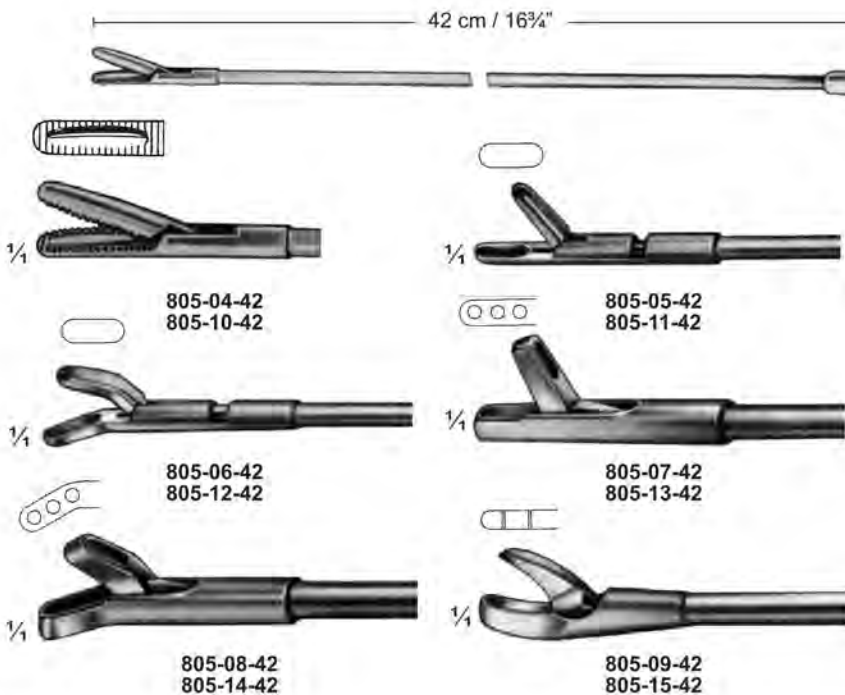

**805-10-42 To 805-15-42**  
 Shaft length 42 cm / 16 1/4"

**Rektum-Biopsiefasszangen**  
**Rectal Biopsy Forceps**  
**Pinces pour biopsie rectale**

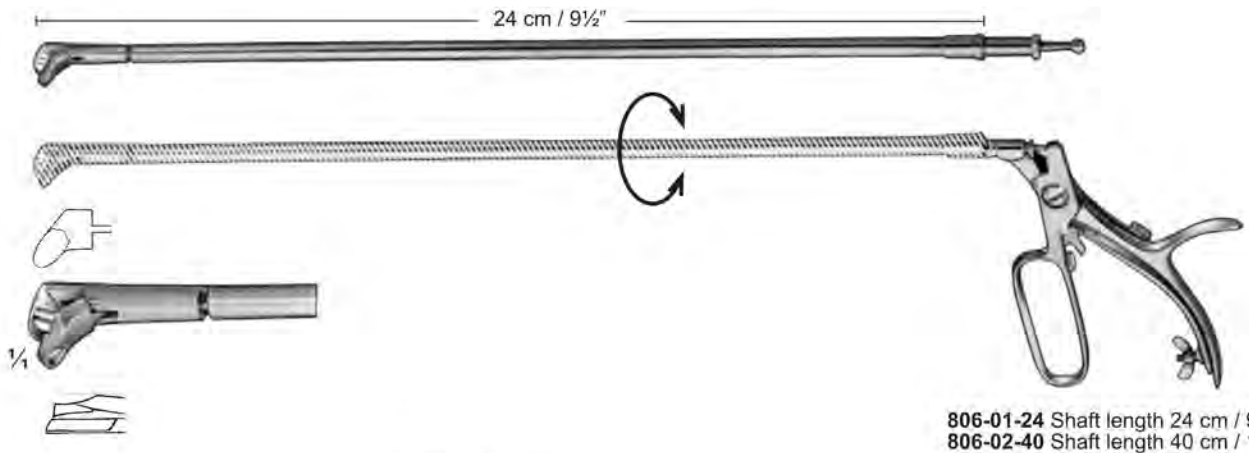

**806-01-24** Shaft length 24 cm / 9 1/2"  
**806-02-40** Shaft length 40 cm / 16"

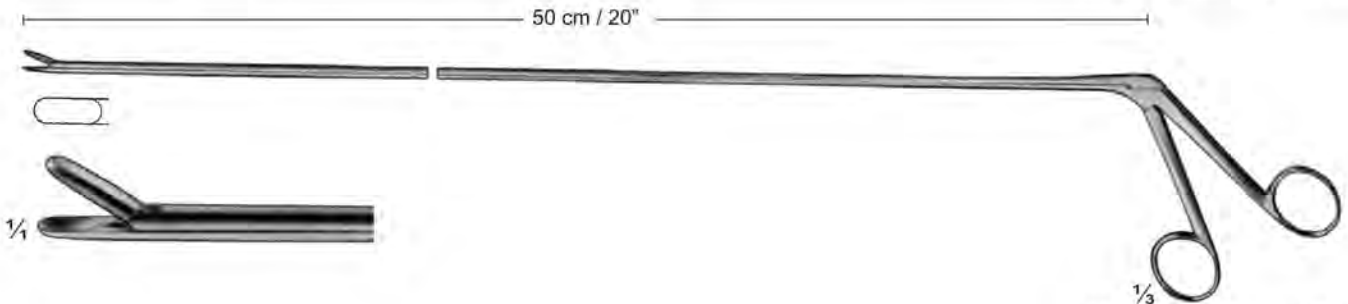

**806-03-35** Shaft length 35 cm / 14"  
**806-04-50** Shaft length 50 cm / 20"

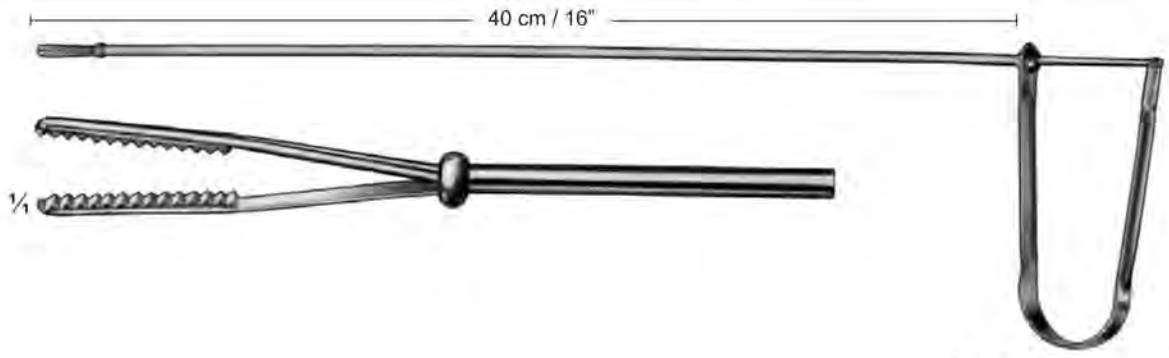

**806-05-40**  
 Shaft length 40 cm / 16"

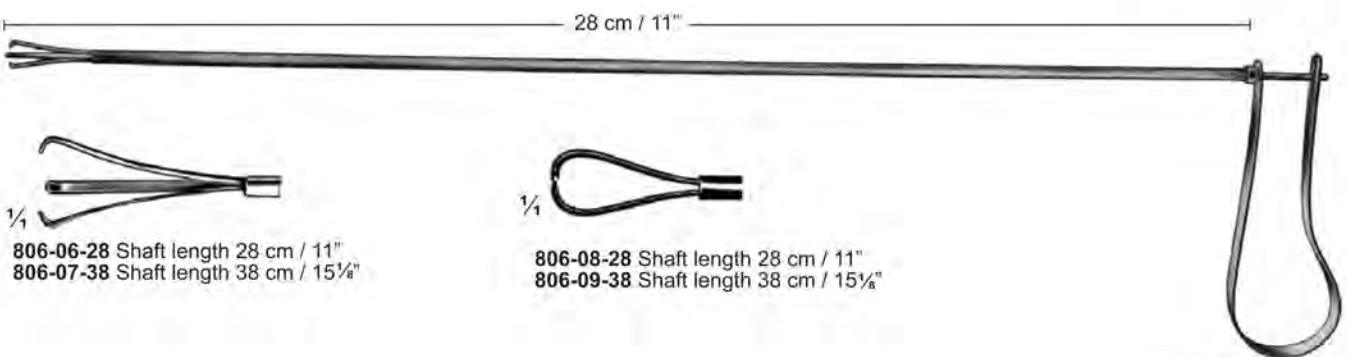

**806-06-28** Shaft length 28 cm / 11"  
**806-07-38** Shaft length 38 cm / 15 1/4"

**806-08-28** Shaft length 28 cm / 11"  
**806-09-38** Shaft length 38 cm / 15 1/4"

**806-06-28 To 806-09**



**Rektum-Biopsiefasszangen**  
**Rectal Biopsy Forceps**  
**Pinces pour biopsie rectale**



**807-01-36**  
 36 cm / 14 1/4"



**807-02-25** 25 cm / 10"  
**807-03-35** 35 cm / 14"  
**807-04-40** 40 cm / 16"  
**807-05-50** 50 cm / 20"

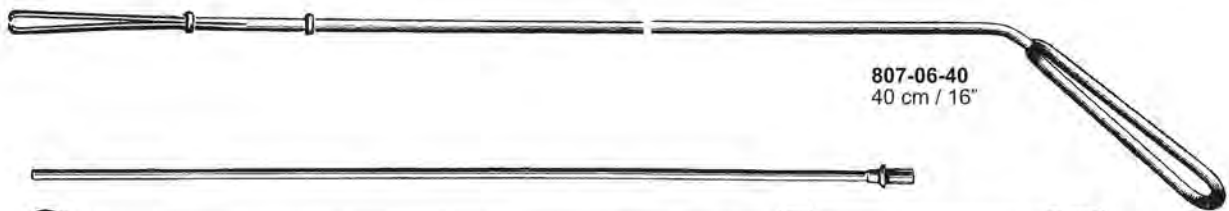

**807-06-40**  
 40 cm / 16"

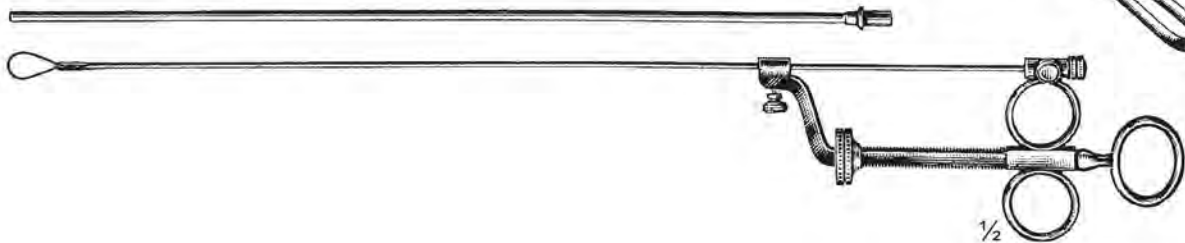

1/2  
**Norwood**  
**807-07-30**  
 30 cm / 12"



1/2  
**Norwood**  
**807-08-30** 30 cm / 12"  
**807-09-40** 40 cm / 16"



**Buie**  
**807-10-40**  
 40 cm / 16", Ch. 10



**Brand**  
**807-11-30** 30 cm / 12", Ø 4 mm  
**807-12-40** 40 cm / 16", Ø 6 mm

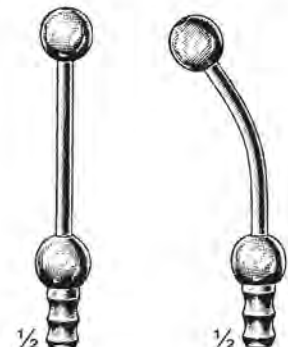

1/2  
**Katzenstein**  
**807-13-09**  
 9 cm / 3 1/2"

1/2  
**Katzenstein**  
**807-09**  
 9 cm / 3 1/2"



**Lungenfasszangen, Bulldogklemmen  
Lung Grasping Forceps, Bulldog Clamps  
Pince-clamps au poumon, Clamps Bulldog**



$\frac{1}{2}$   
Lovelace  
808-01-20  
20 cm / 8"



$\frac{1}{4}$

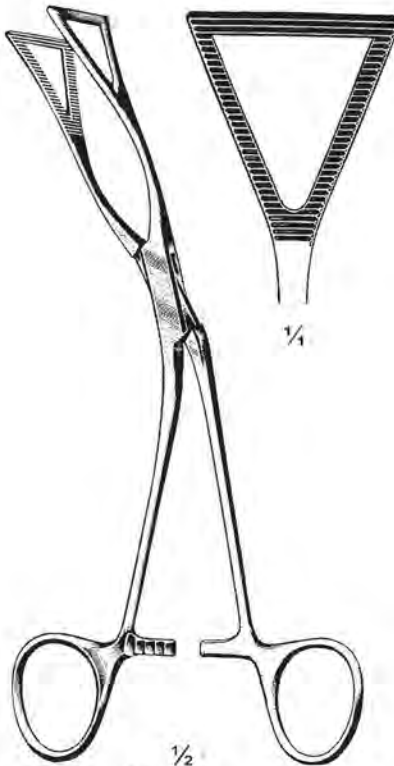

$\frac{1}{2}$   
Lovelace  
808-02-20  
20 cm / 8"



$\frac{1}{4}$

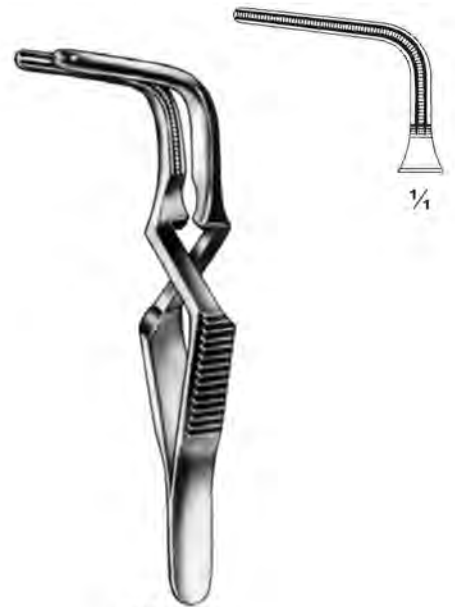

Santulli  
808-03-07  
7 cm / 2 $\frac{3}{4}$ "

$\frac{1}{4}$



$\frac{1}{4}$   
De Bakey  
808-06-07 7.5 cm / 3"  
808-07-08 8.5 cm / 3 $\frac{1}{4}$ "  
808-08-10 10.5 cm / 4 $\frac{1}{8}$ "  
808-09-12 12 cm / 4 $\frac{3}{4}$ "



$\frac{1}{4}$   
De Bakey  
808-10-07 7.5 cm / 3"  
808-11-08 8.5 cm / 3 $\frac{1}{4}$ "  
808-12-10 10.5 cm / 4 $\frac{1}{8}$ "  
808-13-12 12 cm / 4 $\frac{3}{4}$ "



Glover  
808-12-05  
5 cm / 2"



Gregory-Soft  
808-13-09 To 808-14-11  
Carotis

$\frac{1}{4}$

808-13-09  
9 cm / 3 $\frac{1}{2}$ "

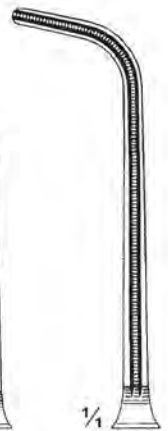

$\frac{1}{4}$

808-14-11  
11 cm / 4 $\frac{1}{4}$ "

**Bulldogklemmen, Arterienklemmen  
Bulldog Clamps, Haemostatic Forceps  
Clamps Bulldog, Pincers Hémostatiques**



De Bakey-Satinsky  
809-01-07  
7 cm / 2 3/4"

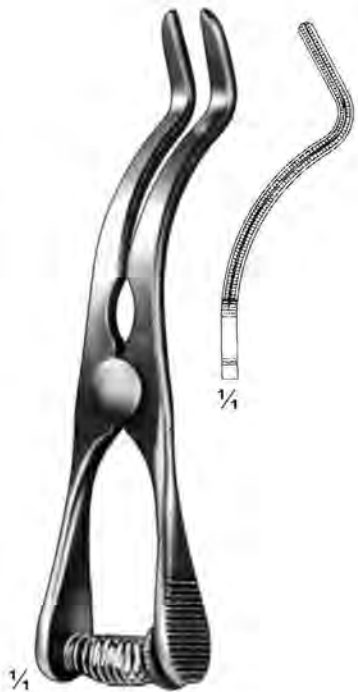

De Bakey-Carotis  
809-02-09  
9 cm / 3 1/2"

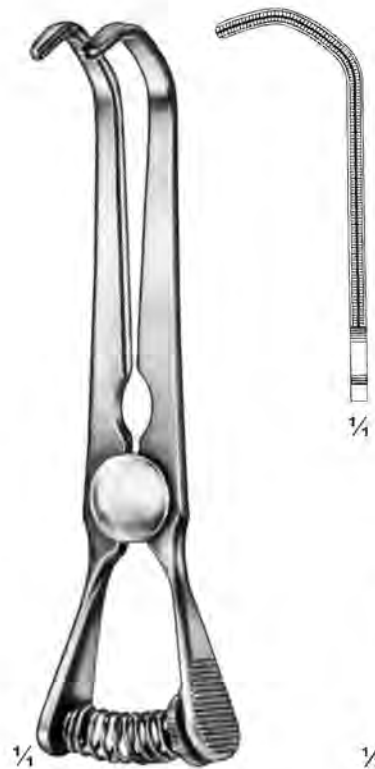

De Bakey-Satinsky  
809-03-10  
10 cm / 4"



De Bakey  
809-04-05  
5 cm / 2"



De Bakey  
809-05-05  
5 cm / 2"



De Bakey  
809-06-07 7.5 cm / 3"  
809-07-08 8.5 cm / 3 1/4"  
809-08-10 10.5 cm / 4 1/8"  
809-09-12 12 cm / 4 3/4"



De Bakey  
809-10-07 7.5 cm / 3"  
809-11-08 8.5 cm / 3 1/4"  
809-12-10 10.5 cm / 4 1/8"  
809-13-12 12 cm / 4 3/4"



809-14 -14To 809-17-16



De Bakey-Kelly  
809-14-14  
14 cm / 5 1/2"



De Bakey-Kelly  
809-15-14  
14 cm / 5 1/2"



De Bakey-Kelly-Rankin  
809-16-16  
16 cm / 6 1/4"



De Bakey-Kelly-Rankin  
809-17-16  
16 cm / 6 1/4"



De Bakey-Mosquito  
809-18-12 To 809-21-15



809-18-12  
12.5 cm / 5"



809-19-12  
12.5 cm / 5"



809-20-15  
15 cm / 6"



809-21-15  
15 cm / 6"

**Bulldogklemmen, Arterienklemmen  
Bulldog Clamps, Haemostatic Forceps  
Clamps Bulldog, Pincers Hémostatiques**

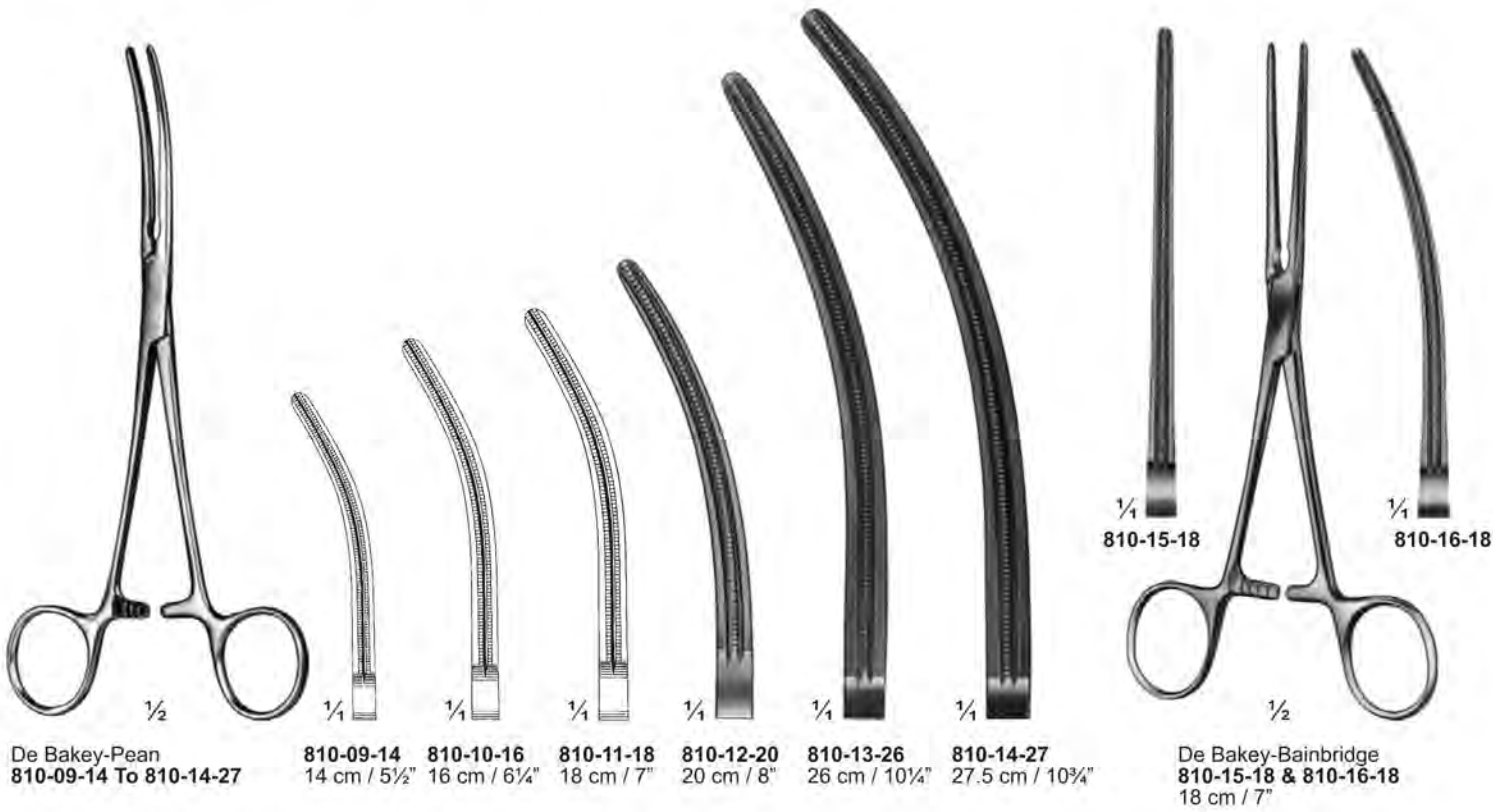
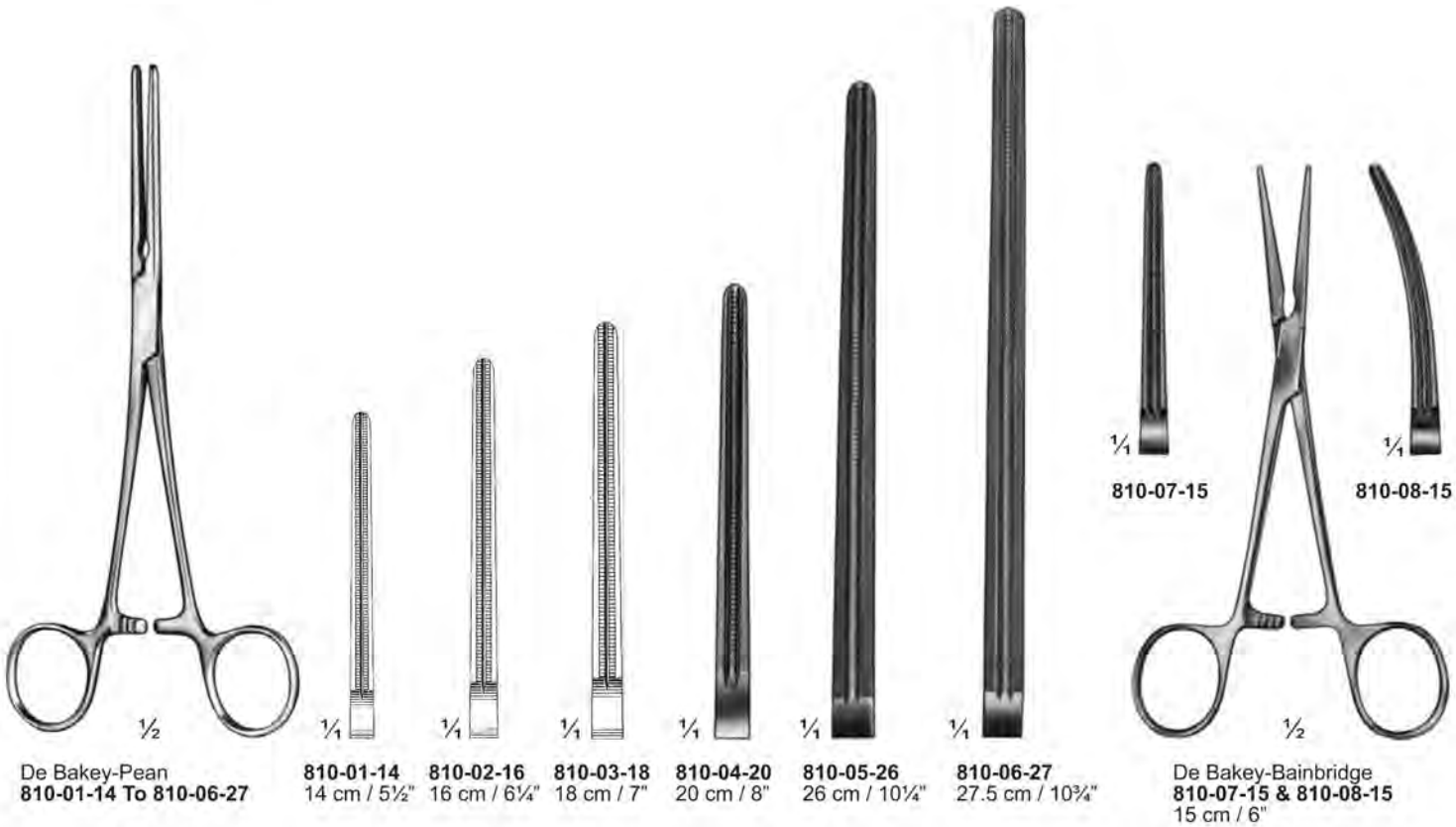

**Mehrzweck-Gefäßklemmen**  
**Atrauma Cardiovascular Forceps**  
**Pinces vasculaires universelles**

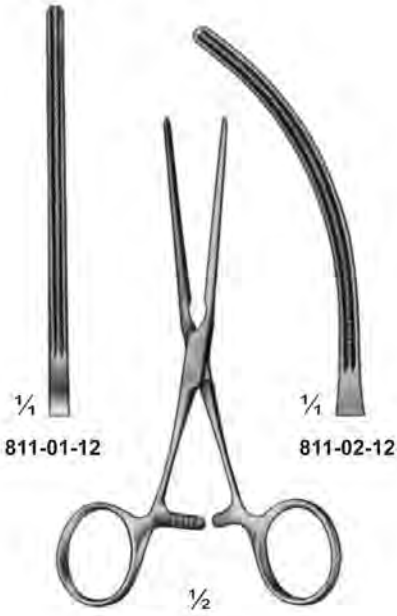

811-01-12      811-02-12

De Bakery  
**811-01-12 & 811-02-12**  
 12.5 cm / 5"



De Bakery  
**811-03-10**  
 10 cm / 4"

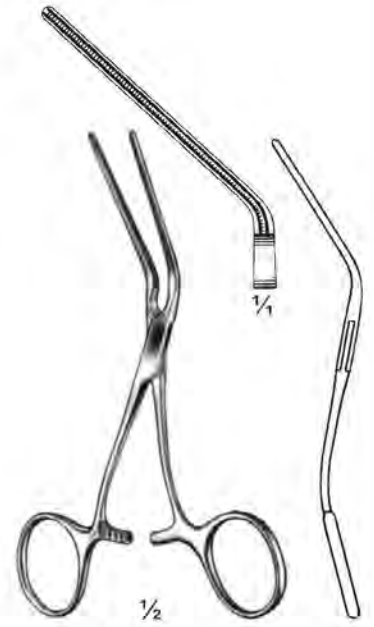

De Bakery  
**811-04-12**  
 12.5 cm / 5"

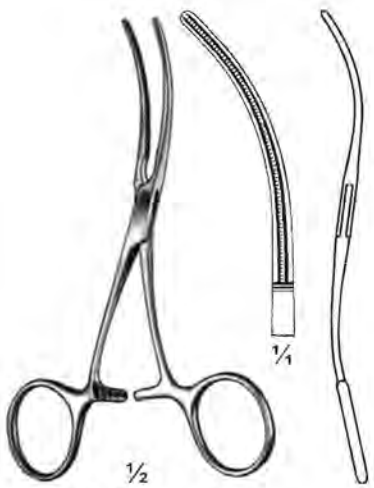

De Bakery  
**811-05-12**  
 12 cm / 4 3/4"

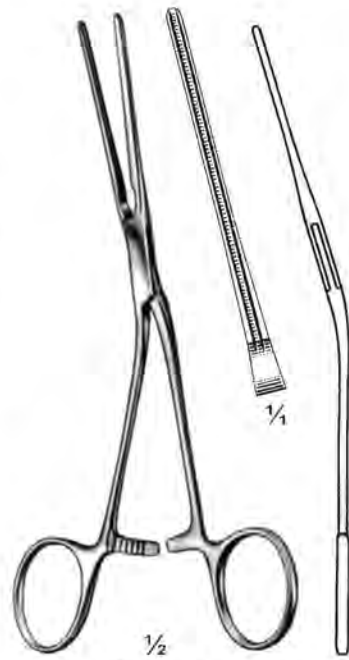

De Bakery  
**811-06-17**  
 17 cm / 6 3/4"

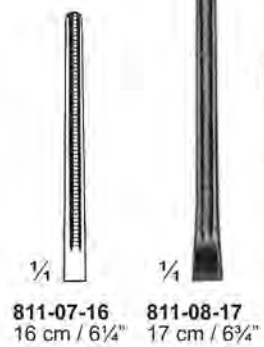

**811-07-16**      **811-08-17**  
 16 cm / 6 1/4"      17 cm / 6 3/4"

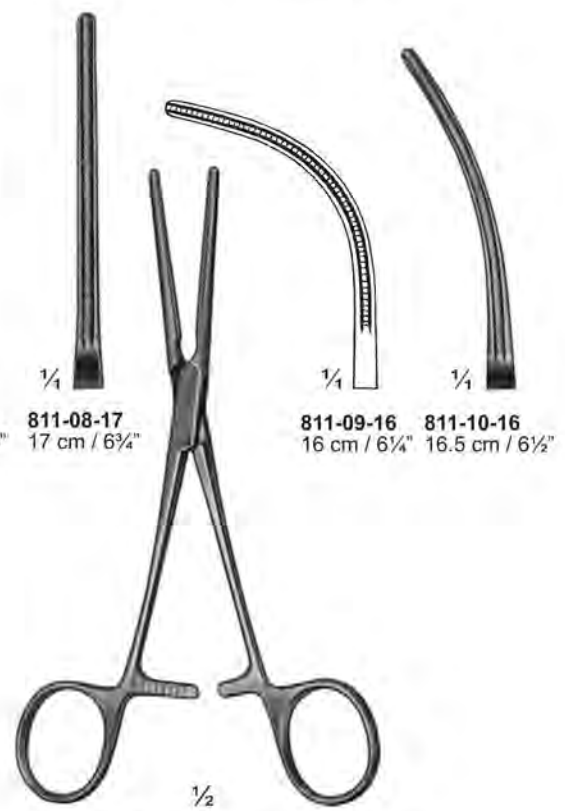

De Bakery  
**811-07-16 To 811-10-16**

Mehrzweck-Gefäßklemmen  
 Atrauma Cardiovascular Forceps  
 Pincés vasculaires universelles

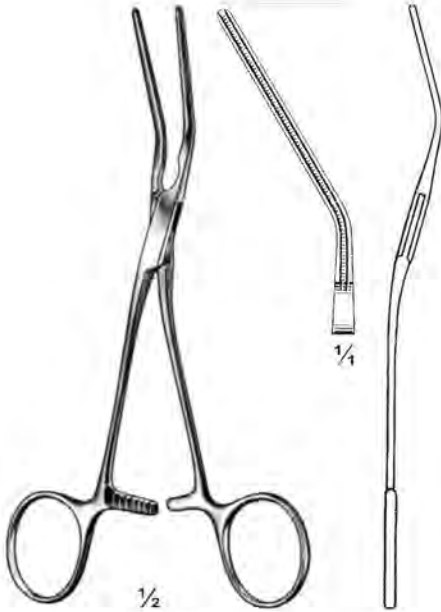

1/2  
 De Bakey  
 812-01-16  
 16 cm / 6 1/4"

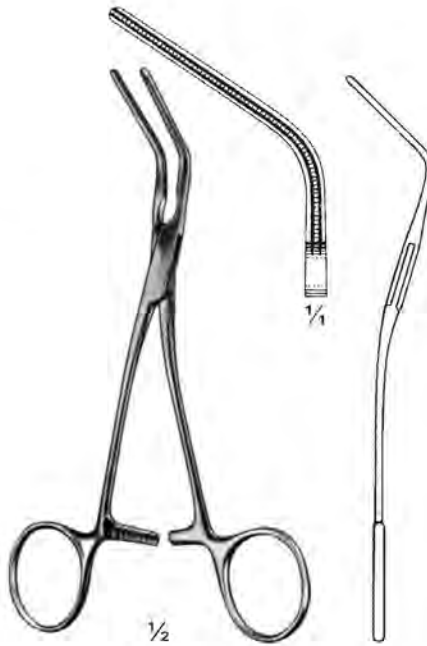

1/2  
 De Bakey  
 812-02-15  
 15 cm / 6"



1/2  
 De Bakey  
 812-03-15  
 15 cm / 6"



1/2  
 De Bakey  
 812-04-18  
 18 cm / 7"



1/2  
 De Bakey  
 812-05-16 & 812-06-17

1/4  
 812-05-16  
 16 cm / 6 1/4"

1/4  
 812-06-17  
 17 cm / 6 3/4"

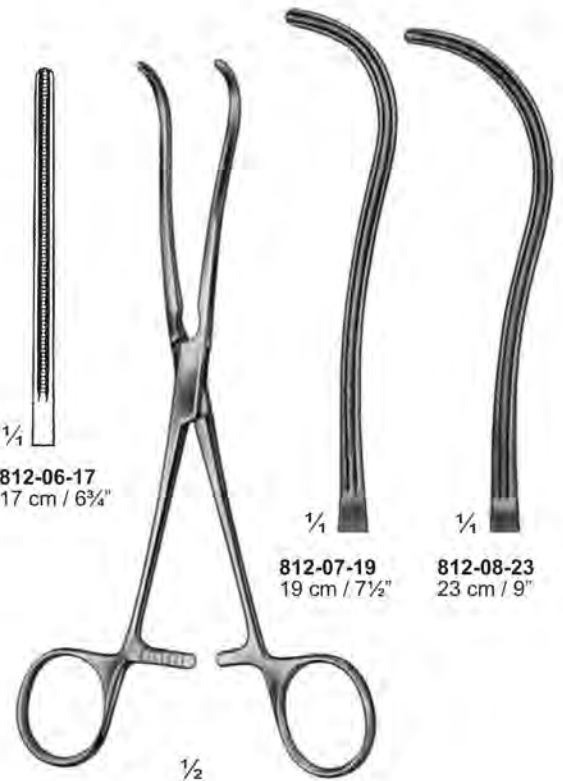

1/2  
 De Bakey  
 812-07-19 & 812-08-23

1/4  
 812-07-19  
 19 cm / 7 1/2"

1/4  
 812-08-23  
 23 cm / 9"



**Mehrzweck-Gefäßklemmen**  
**Atrauma Cardiovascular Forceps**  
**Pinces vasculaires universelles**



De Bakey  
 813-01-21 & 813-02-23



De Bakey  
 813-03-23 To 813-05-25

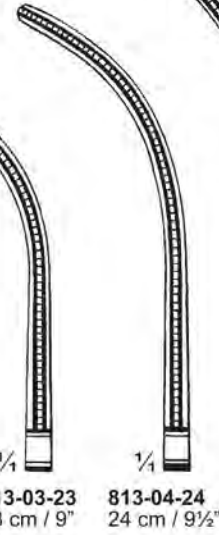
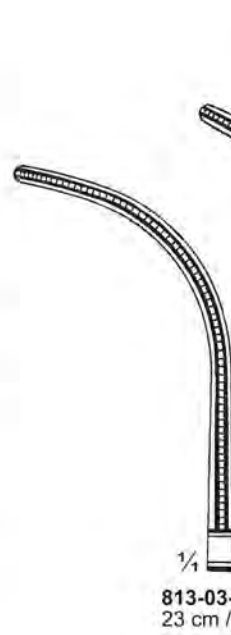

De Bakey  
 813-06-18 To 813-07-20



De Bakey  
 813-08-24  
 24 cm / 9 1/2"

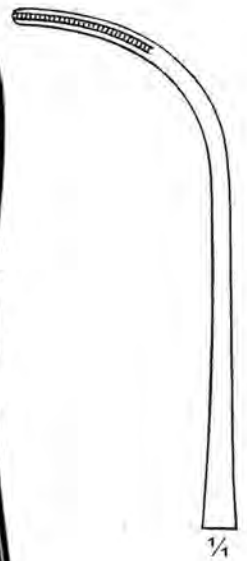

Mehrzweck-Gefäßklemmen  
 Atrauma Cardiovascular Forceps  
 Pincés vasculaires universelles



$\frac{1}{4}$	$\frac{1}{4}$	$\frac{1}{4}$	$\frac{1}{4}$
<b>814-01-26</b> 26 cm / 10 $\frac{1}{4}$ "	<b>814-02-27</b> 27 cm / 10 $\frac{1}{2}$ "	<b>814-03-31</b> 31 cm / 12 $\frac{1}{4}$ "	<b>814-04-33</b> 33 cm / 13"

$\frac{1}{2}$   
 De Bakey  
 814-01-26 To 814-04-33

$\frac{1}{2}$   
 De Bakey  
 814-05-28  
 28 cm / 11"

Mehrzweck-Gefäßklemmen  
 Atrauma Cardiovascular Forceps  
 Pincers vasculaires universelles

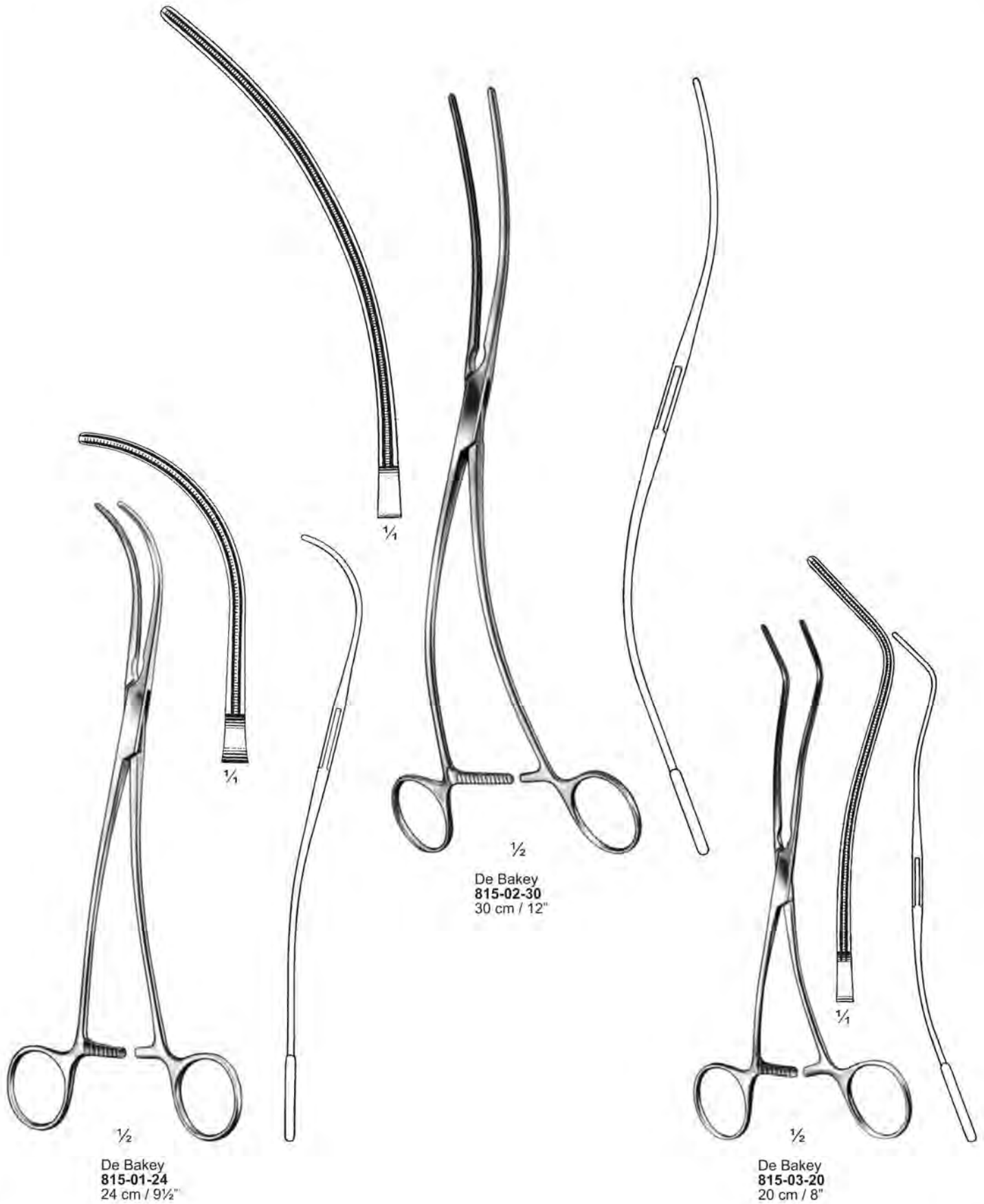



**Mehrzweck-Gefäßklemmen**  
**Atrauma Cardiovascular Forceps**  
**Pinces vasculaires universelles**

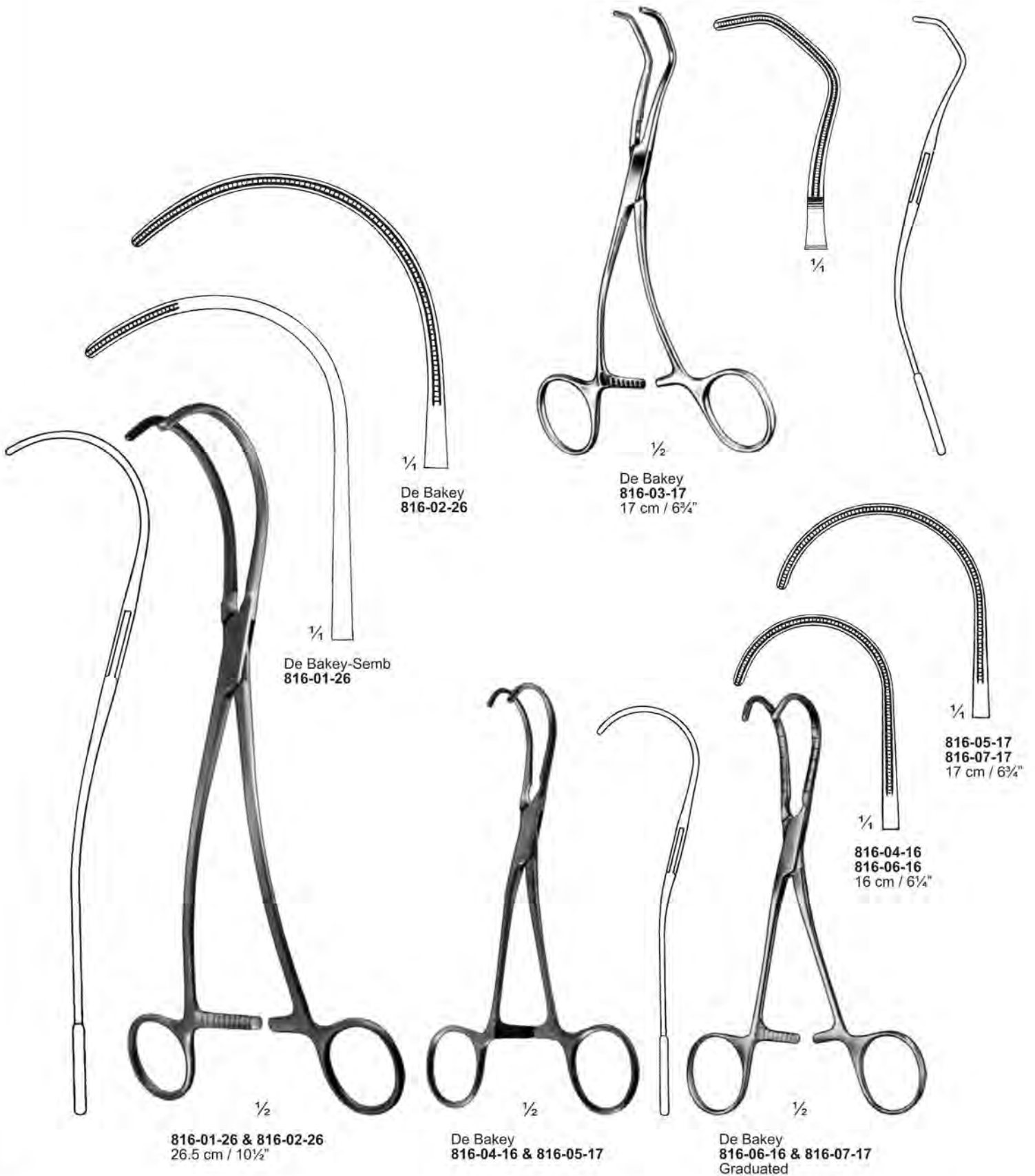

Mehrzweck-Gefäßklemmen  
 Atrauma Cardiovascular Forceps  
 Pincés vasculaires universelles



De Bakey  
 817-01-27  
 27 cm / 10½"

De Bakey-Mixter  
 817-02-28  
 28.5 cm / 11¼"

De Bakey-Rumel  
 817-03-25 To 817-04-24



Mehrzweck-Gefäßklemmen  
Atrauma Cardiovascular Forceps  
Pincés vasculaires universelles

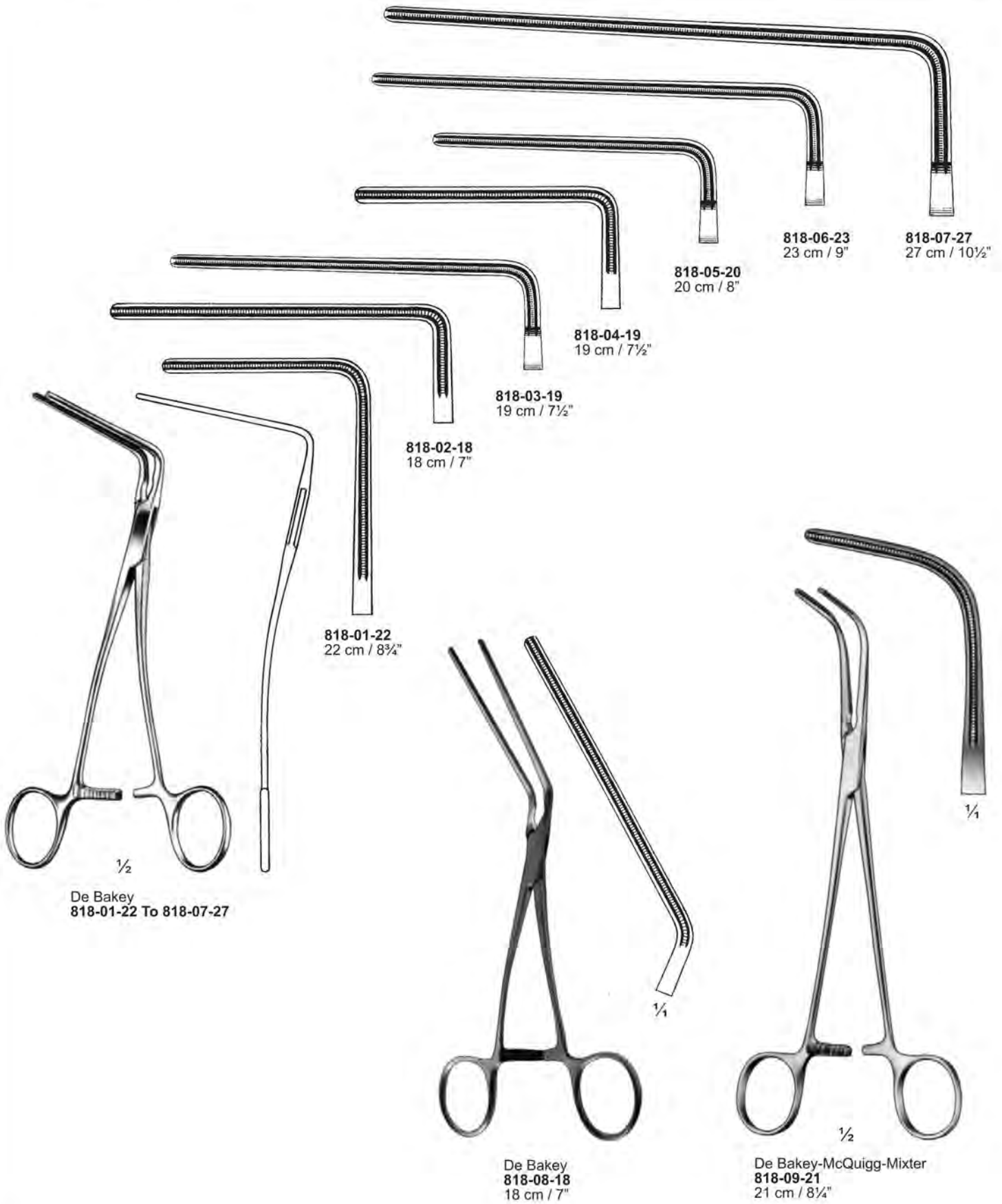

Mehrzweck-Gefäßklemmen  
 Atrauma Cardiovascular Forceps  
 Pincers vasculaires universelles

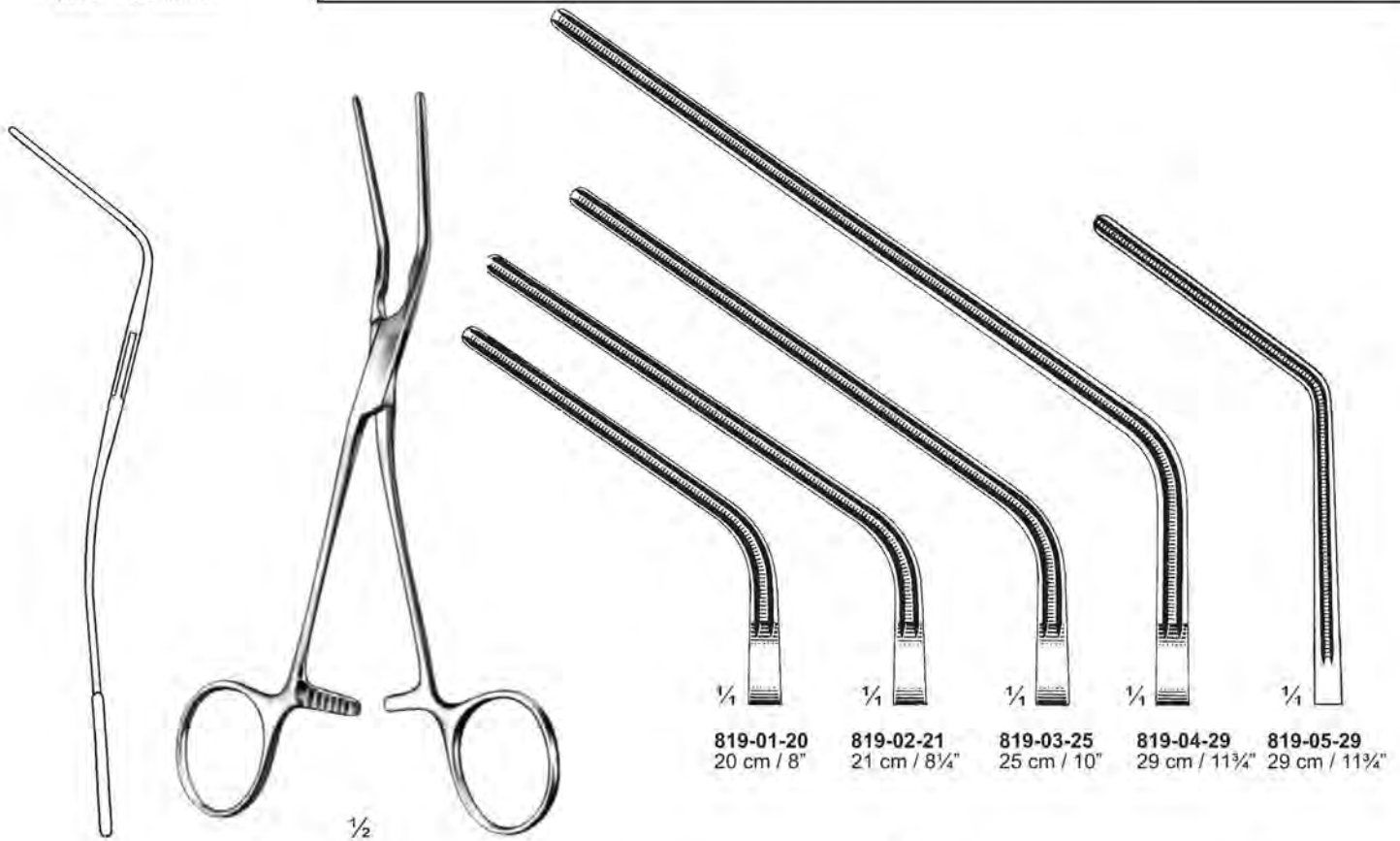

819-01-20 20 cm / 8"	819-02-21 21 cm / 8¼"	819-03-25 25 cm / 10"	819-04-29 29 cm / 11¼"	819-05-29 29 cm / 11¼"
-------------------------	--------------------------	--------------------------	---------------------------	---------------------------

De Bakey  
 819-01-20 To 819-05-29

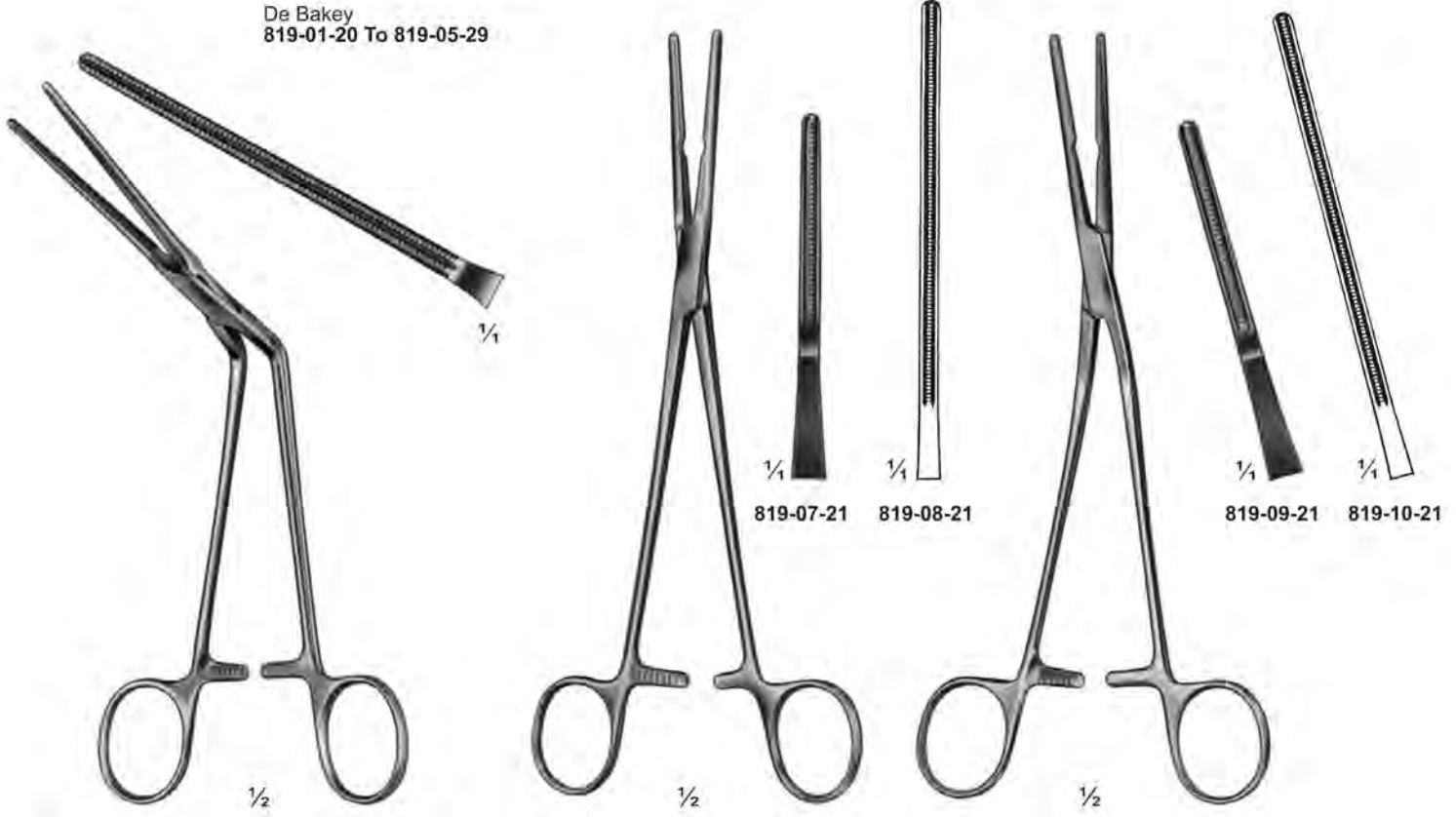

819-07-21	819-08-21	819-09-21	819-10-21
-----------	-----------	-----------	-----------

De Bakey  
 819-06-20  
 20 cm / 8"

De Bakey  
 819-07-21 To 819-08-21  
 21 cm / 8¼"

De Bakey  
 819-09-21 To 819-10-21  
 21 cm / 8¼"

Mehrzweck-Gefäßklemmen  
 Atrauma Cardiovascular Forceps  
 Pincés vasculaires universelles



$\frac{1}{2}$   
 Morris-De Bakey  
 820-01-18 To 820-04-25

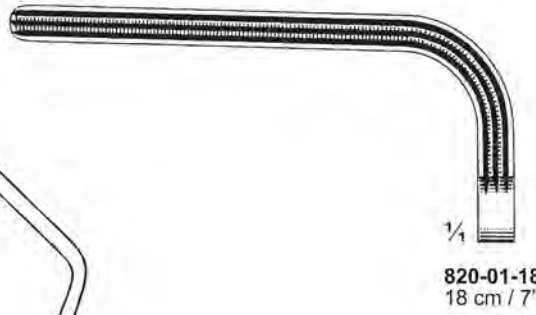
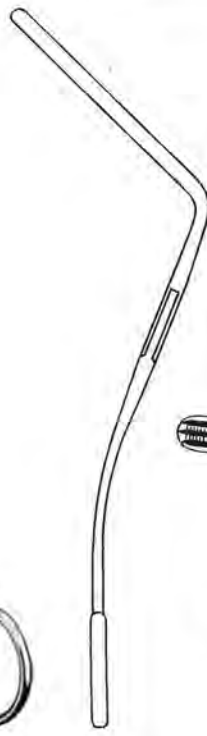

$\frac{1}{4}$   
 820-01-18  
 18 cm / 7"

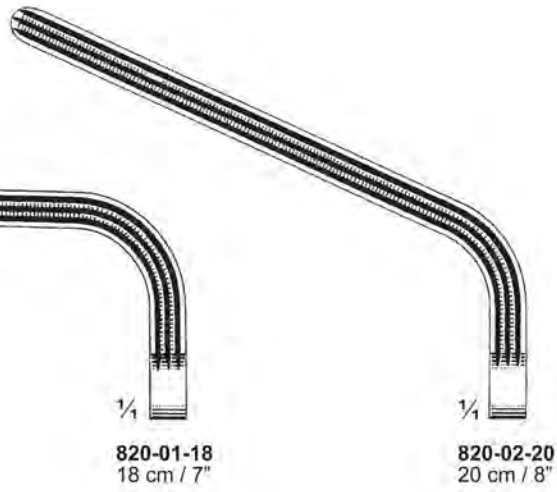

$\frac{1}{4}$   
 820-02-20  
 20 cm / 8"

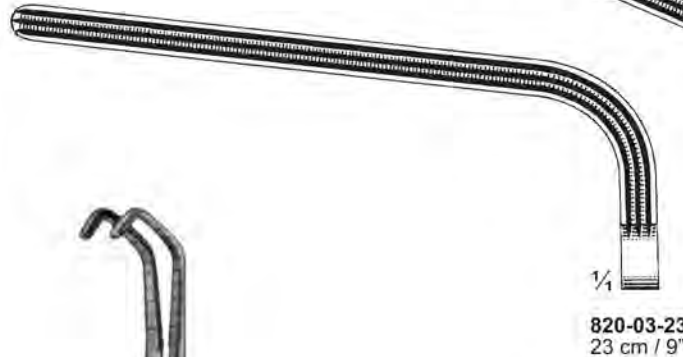

$\frac{1}{4}$   
 820-03-23  
 23 cm / 9"

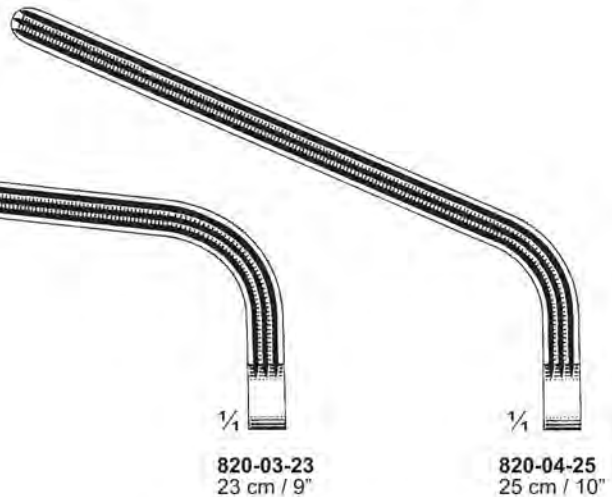

$\frac{1}{4}$   
 820-04-25  
 25 cm / 10"



$\frac{1}{2}$   
 De Bakey-Beck  
 820-05-20 & 820-06-21



$\frac{1}{4}$   
 820-05-20  
 20 cm / 8"

$\frac{1}{4}$   
 820-06-21  
 21 cm / 8 $\frac{1}{4}$ "

Mehrzweck-Gefäßklemmen  
 Atrauma Cardiovascular Forceps  
 Pincers vasculaires universelles



Glover  
 821-01-17 To 821-03-24

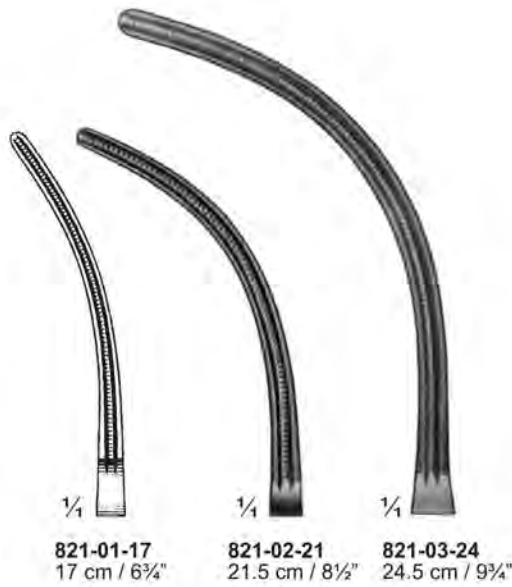

Glover  
 821-04-17 To 821-05-22

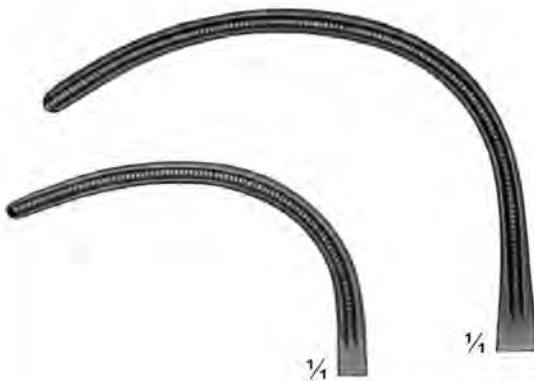

Glover  
 821-06-19 & 821-07-21

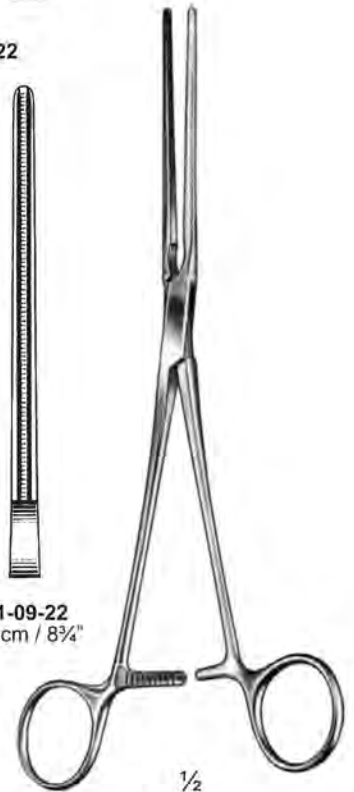
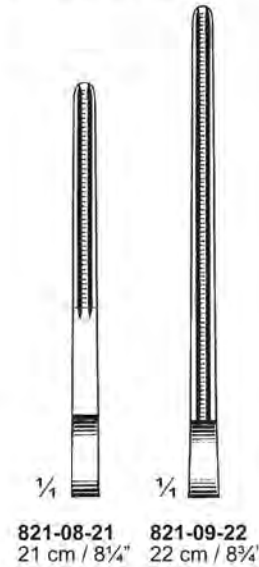

Potts  
 821-08-21 & 821-09-22

Mehrzweck-Gefäßklemmen  
 Atrauma Cardiovascular Forceps  
 Pincers vasculaires universelles



Potts  
 822-01-21 & 822-02-22

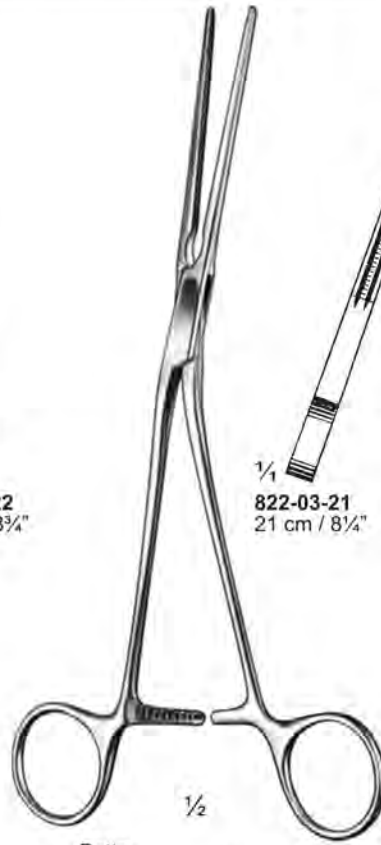
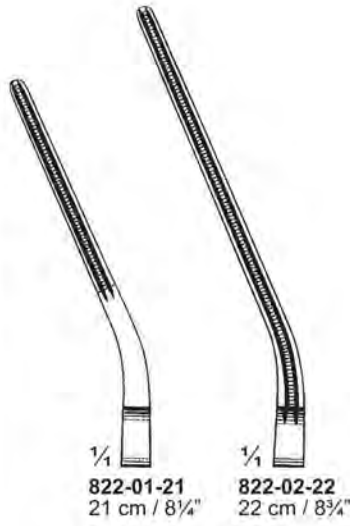

Potts  
 822-03-21 & 822-04-22

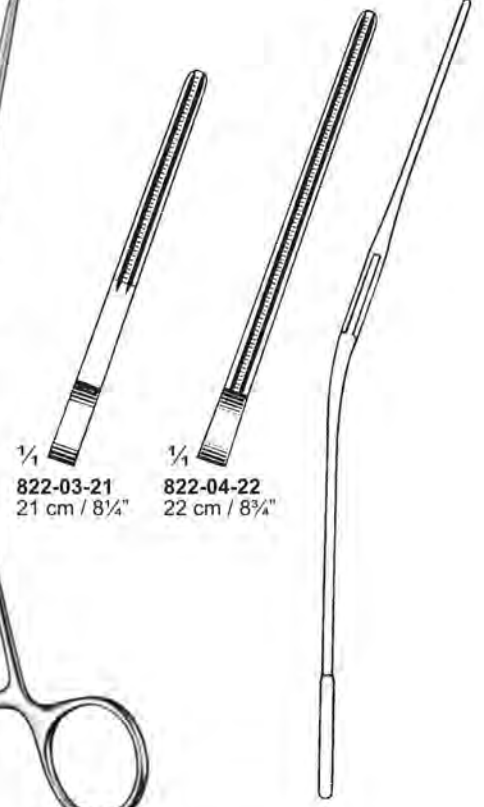

Potts  
 822-05-22  
 22 cm / 8 3/4"

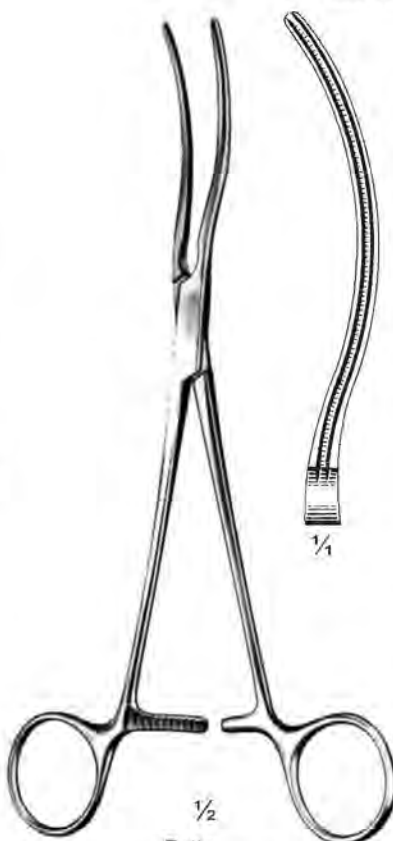

Potts  
 822-06-22  
 22 cm / 8 3/4"

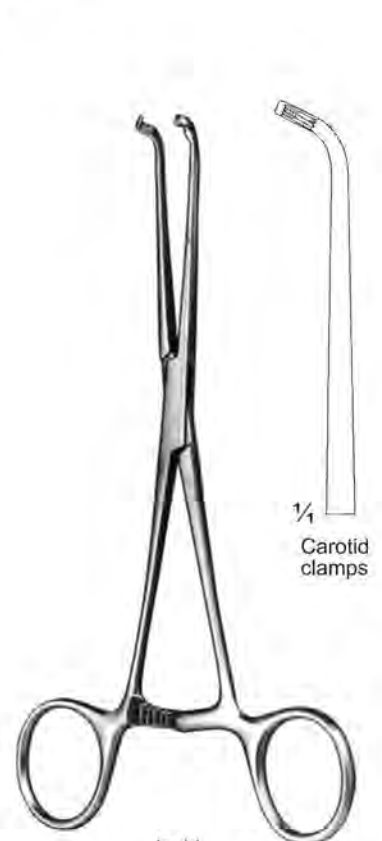

Javid  
 822-07-18  
 18 cm / 7"

Mehrzweck-Gefäßklemmen  
 Atrauma Cardiovascular Forceps  
 Pincés vasculaires universelles

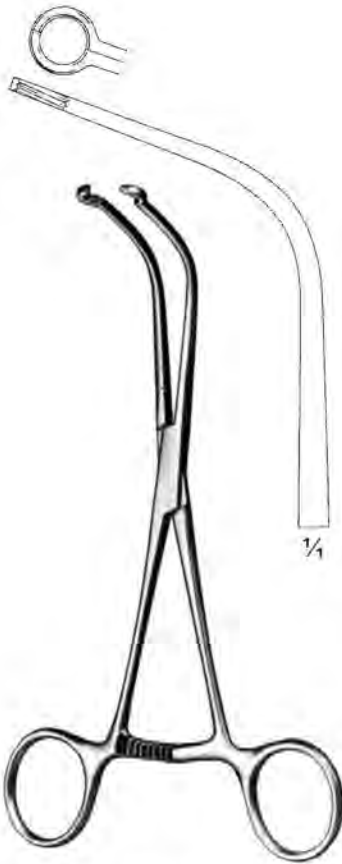

Javid  
 823-01-19  
 19 cm / 7½"



823-02-21 To 823-05-31



¼  
 823-02-21  
 21.5 cm / 8½"



¼  
 823-03-23  
 23 cm / 9"



¼  
 823-04-27  
 27 cm / 10½"



¼  
 823-05-31  
 31.5 cm / 12½"



823-06-21 To 823-09-31



¼  
 823-06-21  
 21.5 cm / 8½"



¼  
 823-07-23  
 23 cm / 9"



¼  
 823-08-27  
 27 cm / 10½"



¼  
 823-09-31  
 31.5 cm / 12½"



Mehrzweck-Gefäßklemmen  
 Atrauma Cardiovascular Forceps  
 Pincés vasculaires universelles



1/2

Satinsky  
 824-01-20 To 824-05-27

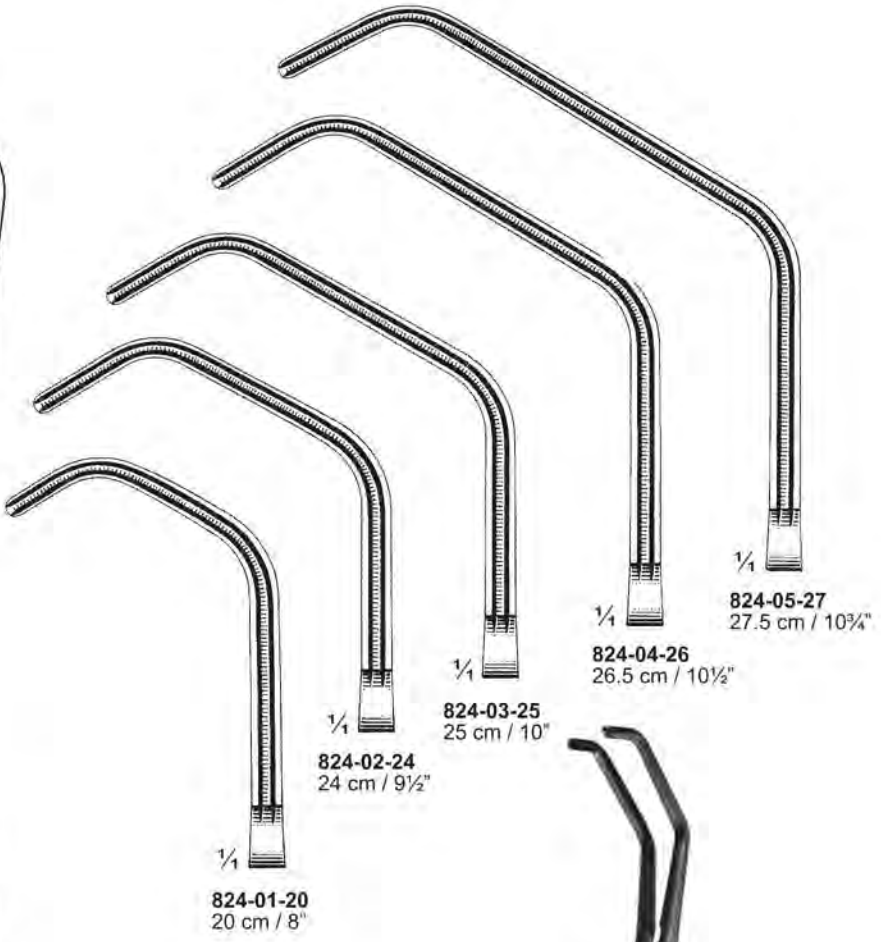

824-01-20  
 20 cm / 8"

824-02-24  
 24 cm / 9 1/2"

824-03-25  
 25 cm / 10"

824-04-26  
 26.5 cm / 10 1/2"

824-05-27  
 27.5 cm / 10 3/4"

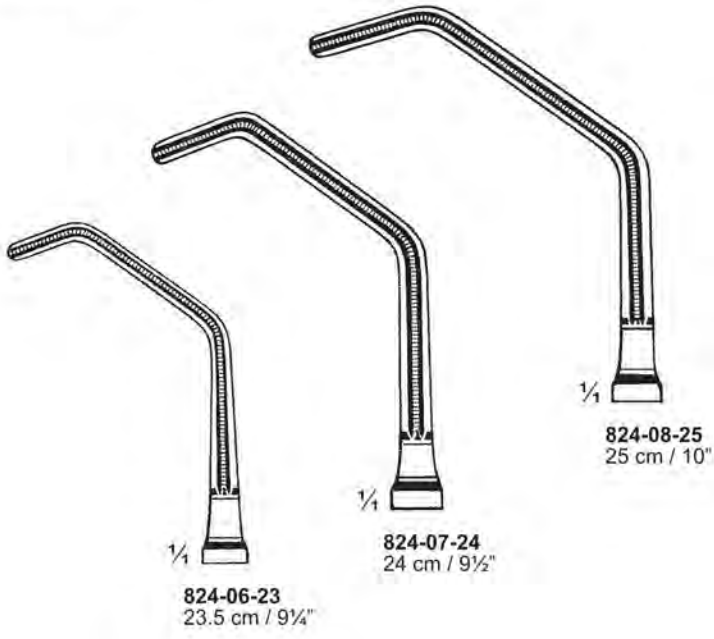

824-06-23  
 23.5 cm / 9 1/4"

824-07-24  
 24 cm / 9 1/2"

824-08-25  
 25 cm / 10"



Satinsky-De Bakey  
 824-06-23 To 824-08-25

Mehrzweck-Gefäßklemmen  
 Atrauma Cardiovascular Forceps  
 Pincers vasculaires universelles



$\frac{1}{4}$   
 Lambert-Kay  
 825-01-21  
 21 cm / 8 $\frac{1}{4}$ "



$\frac{1}{4}$   
 Lambert-Kay  
 825-02-21  
 21.5 cm / 8 $\frac{1}{2}$ "



$\frac{1}{4}$   
 Lambert-Kaya Modif.  
 825-03-25  
 25 cm / 10"



$\frac{1}{2}$   
 825-01-21 To 825-03-25



$\frac{1}{4}$   
 Glover-De Bakey  
 825-04-23  
 23 cm / 9"



$\frac{1}{4}$   
 $\frac{1}{2}$   
 Atlee  
 825-05-24  
 24.5 cm / 9 $\frac{3}{4}$ "

Mehrzweck-Gefäßklemmen  
 Atrauma Cardiovascular Forceps  
 Pincers vasculaires universelles



Lees  
 826-01-23 & 826-02-25

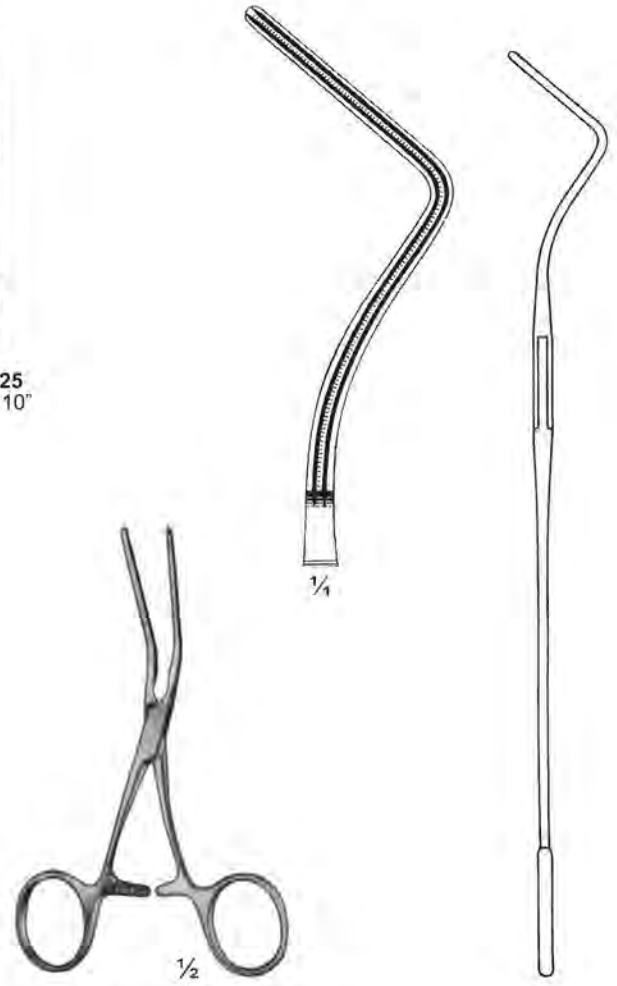
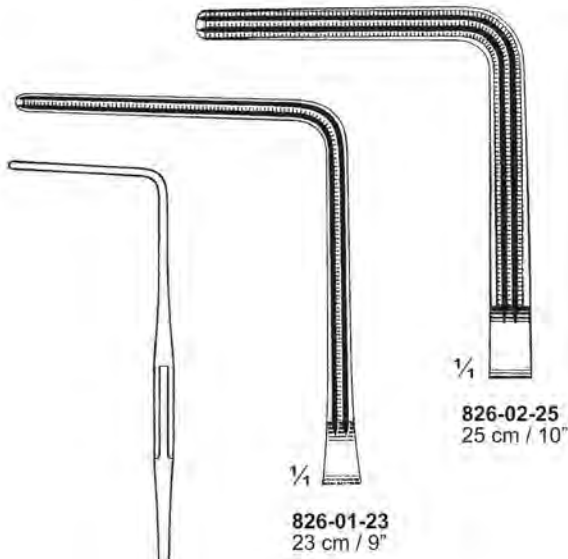

Lees  
 826-03-25  
 25 cm / 10"

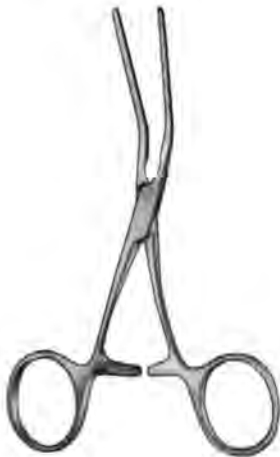

Castaneda  
 826-04-12 To 826-07-10  
 Graduated

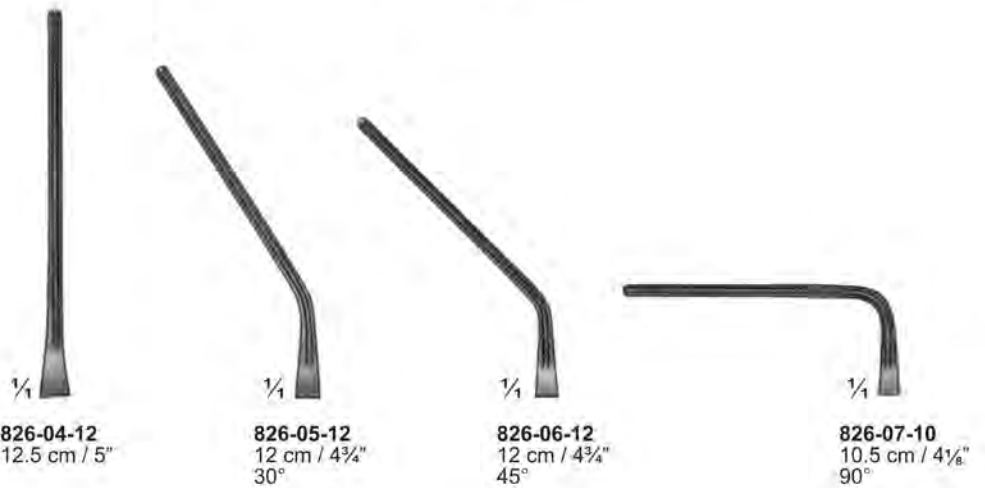

**Mehrzweck-Gefäßklemmen**  
**Atrauma Cardiovascular Forceps**  
**Pinces vasculaires universelles**



$\frac{1}{2}$   
 De Bakey-Harken  
 827-01-25 To 827-04-24



$\frac{1}{4}$   
 827-01-25  
 25 cm / 10"



$\frac{1}{4}$   
 827-02-24  
 24.5 cm / 9 $\frac{3}{4}$ "



$\frac{1}{4}$   
 827-03-24  
 24.5 cm / 9 $\frac{3}{4}$ "



$\frac{1}{4}$   
 827-04-24  
 24.5 cm / 9 $\frac{3}{4}$ "



$\frac{1}{4}$   
 827-05-20  
 20 cm / 8"



$\frac{1}{4}$   
 827-06-19  
 19 cm / 7 $\frac{1}{2}$ "

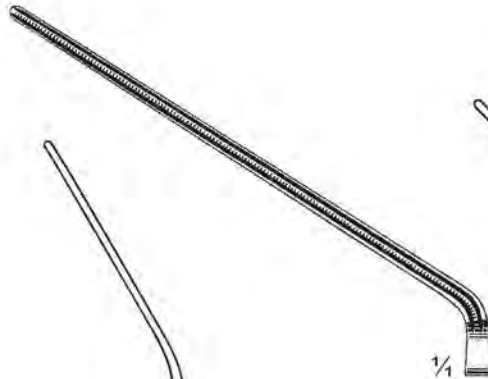

$\frac{1}{4}$   
 827-07-18  
 18 cm / 7"

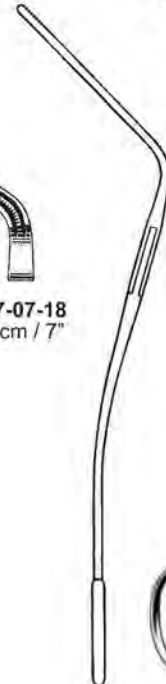

$\frac{1}{2}$   
 Leland-Jones  
 827-05-20 To 827-07-18



Mehrzweck-Gefäßklemmen  
Atrauma Cardiovascular Forceps  
Pinces vasculaires universelles

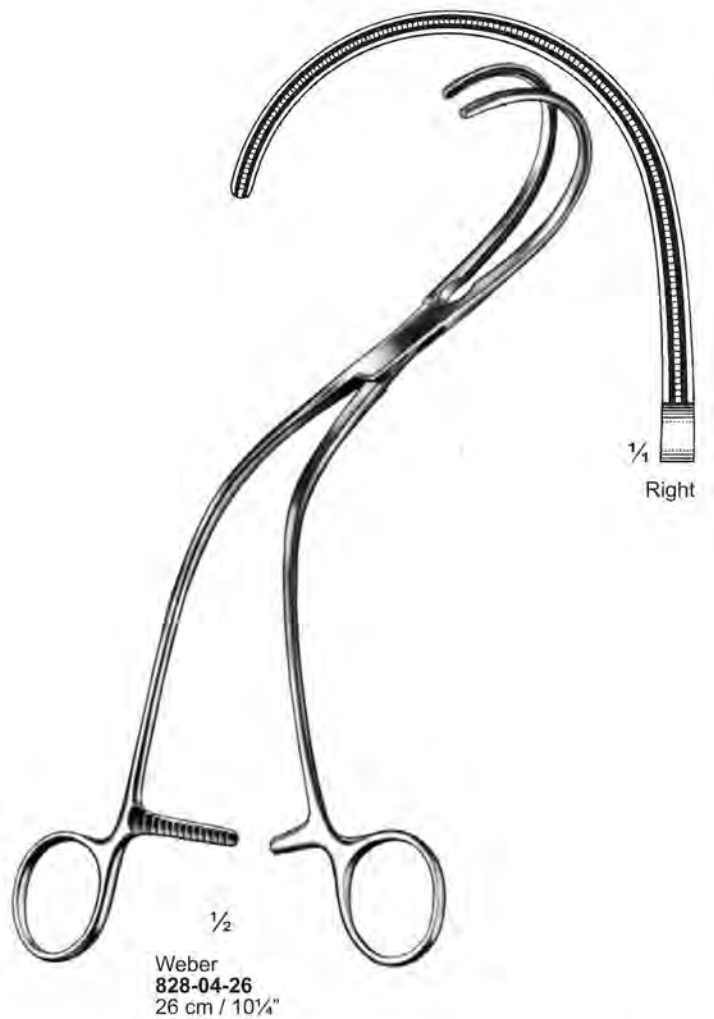
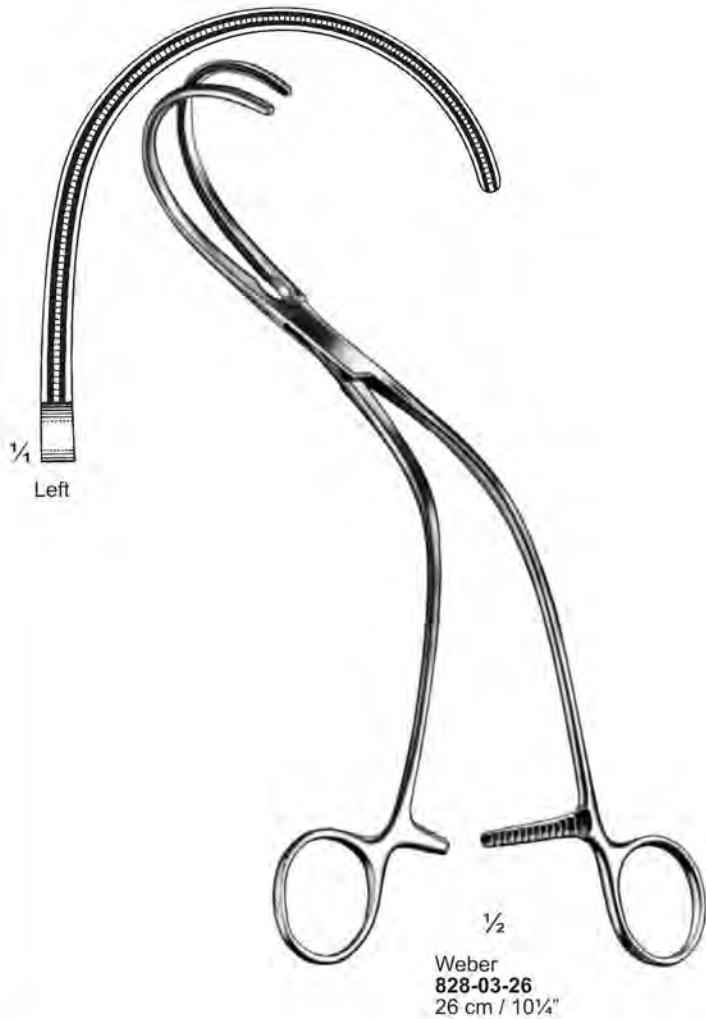
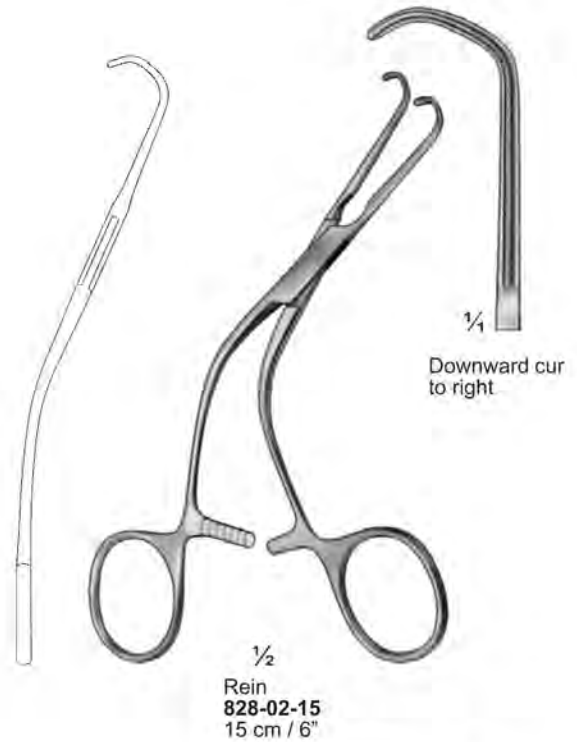
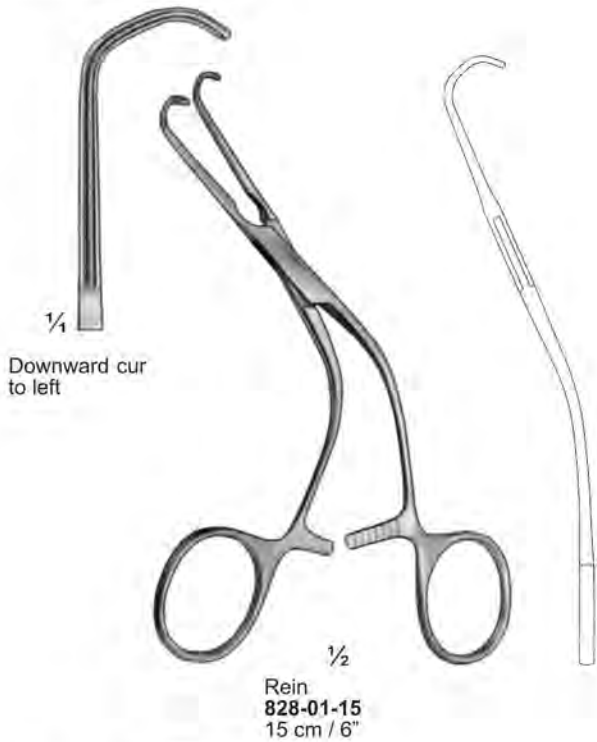

**Mehrzweck-Gefäßklemmen**  
**Atrauma Cardiovascular Forceps**  
**Pinces vasculaires universelles**



Castaneda  
 829-01-15 To 829-04-15  
 Graduated



1/4  
 829-01-15  
 15 cm / 6"



1/4  
 829-02-15  
 15 cm / 6"



1/4  
 829-03-15  
 15 cm / 6"



1/4  
 829-04-15  
 15 cm / 6"



1/2  
 Dietrich  
 829-05-21  
 21 cm / 8 1/4"

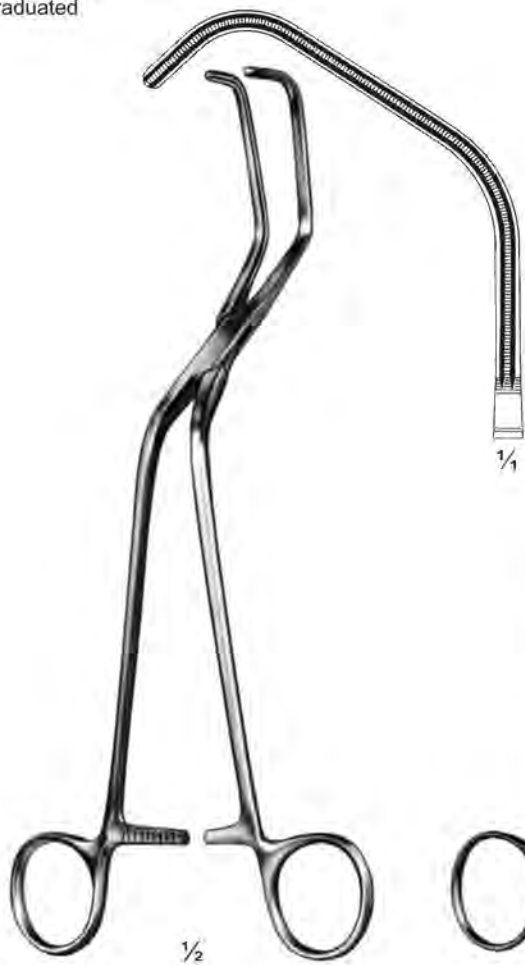

1/2  
 Ochsner  
 829-06-23  
 23.5 cm / 9 1/4"



1/2  
 Gregory  
 829-07-14 To 829-09-18



1/4  
 829-07-14  
 14 cm / 5 1/2"

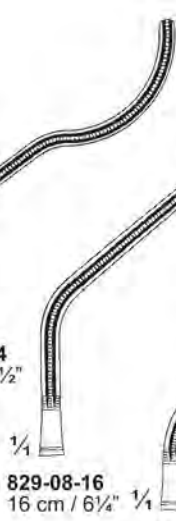

1/4  
 829-08-16  
 16 cm / 6 1/4"

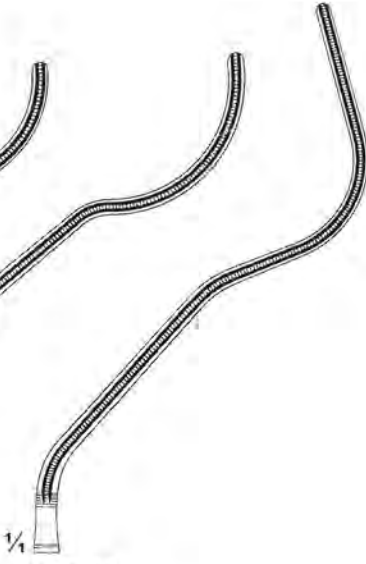

1/4  
 829-09-18  
 18 cm / 7"

Mehrzweck-Gefäßklemmen  
 Atrauma Cardiovascular Forceps  
 Pincers vasculaires universelles



830-01-13  
 13 cm / 5 1/8"

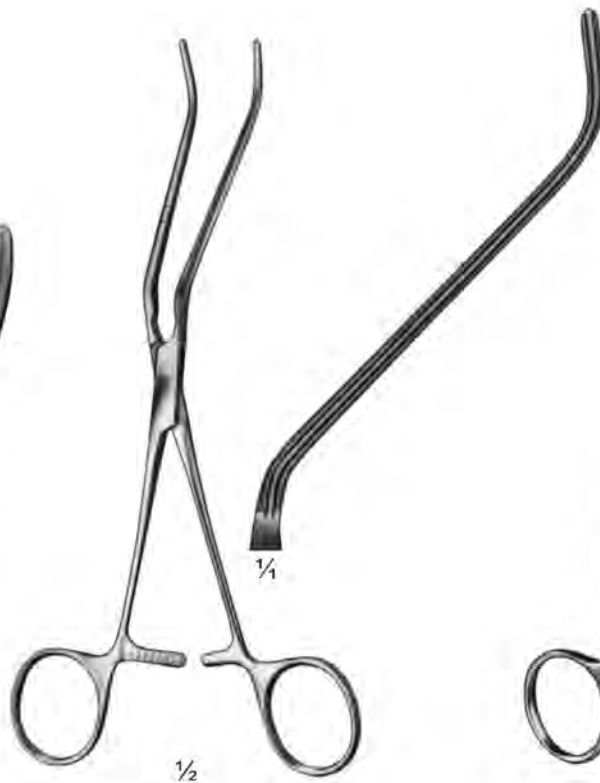

Henly  
 830-02-19  
 19.5 cm / 7 3/4"  
 Graduated

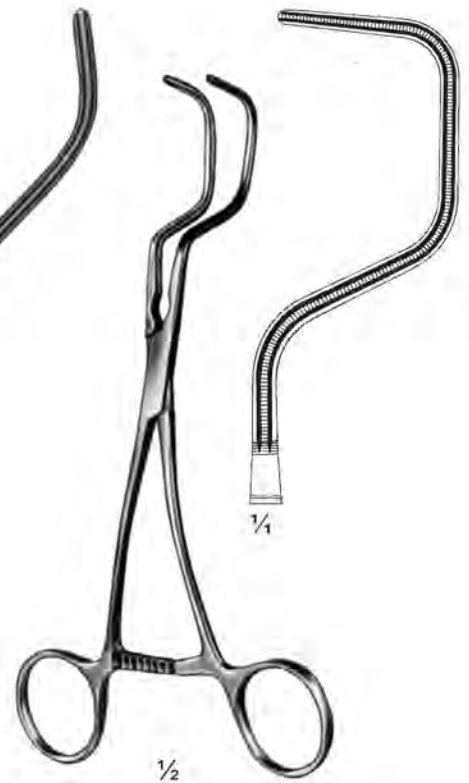

Dale  
 830-03-18  
 18.5 cm / 7 1/4"

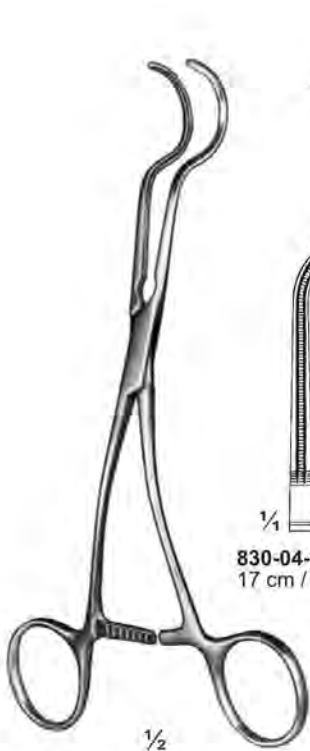

Dale  
 830-04-17 To 830-06-18

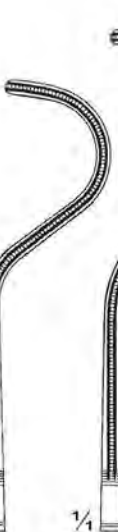

830-04-17  
 17 cm / 6 3/4"



830-05-18  
 18 cm / 7"



830-06-18  
 18.5 cm / 7 1/4"



Derra  
 830-07-16 To 830-09-18



830-07-16  
 16 cm / 6 1/4"



830-08-17  
 17 cm / 6 3/4"

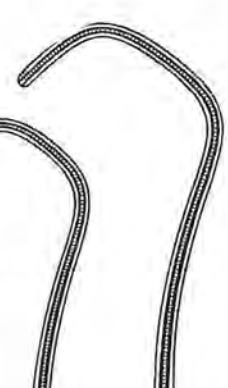

830-09-18  
 18 cm / 7"

Mehrzweck-Gefäßklemmen  
 Atrauma Cardiovascular Forceps  
 Pincers vasculaires universelles

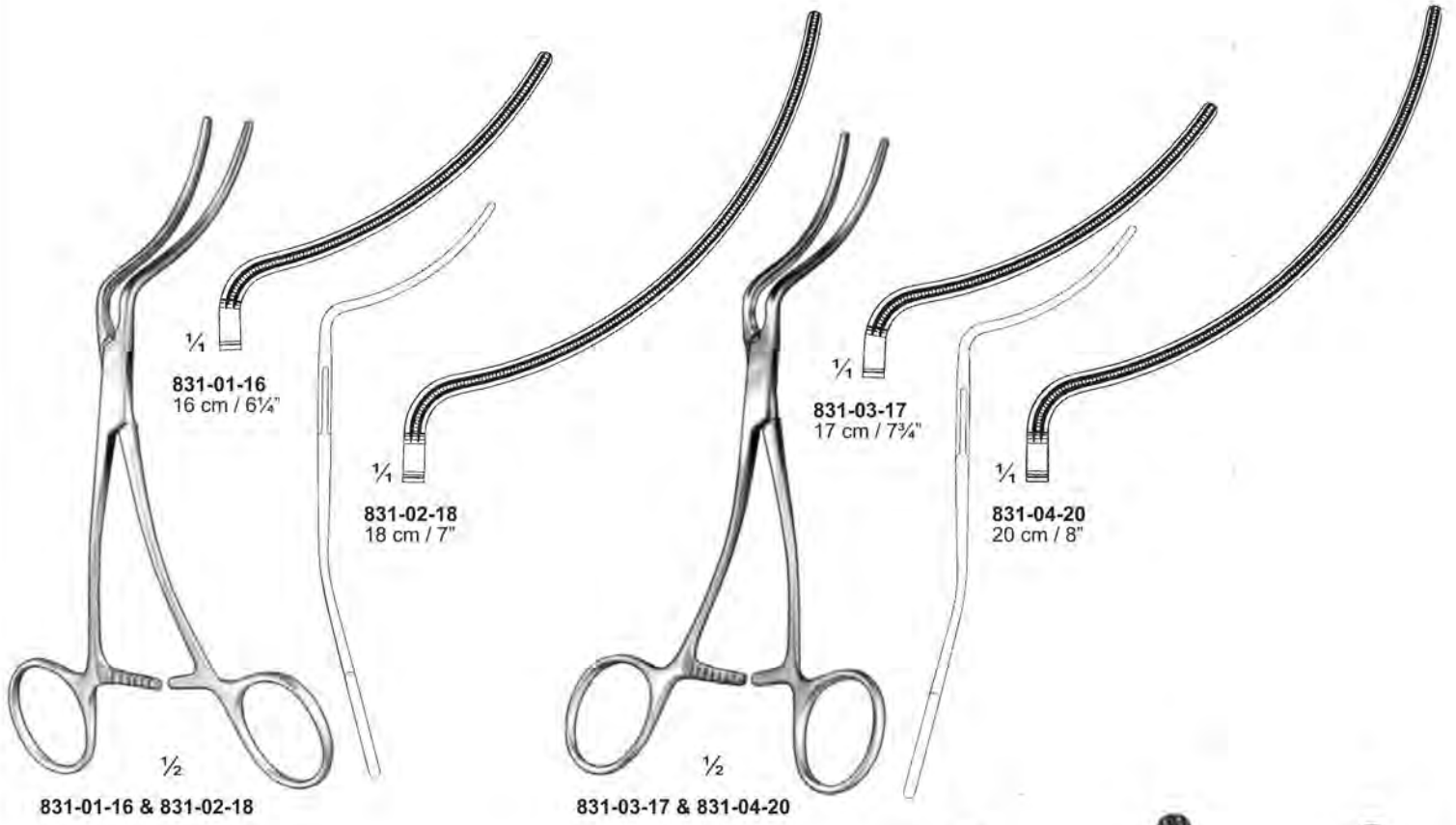



**Mehrzweck-Gefäßklemmen**  
**Atrauma Cardiovascular Forceps**  
**Pinces vasculaires universelles**



For children	Charriere
832-01-24	16 cm / 6 1/4" 24
832-02-26	16 cm / 6 1/4" 26
For adults	
832-03-28	20 cm / 8" 28
832-04-30	20 cm / 8" 30
832-05-32	20 cm / 8" 32
832-06-36	20 cm / 8" 36

Cooley  
832-01-24 To 832-06-36

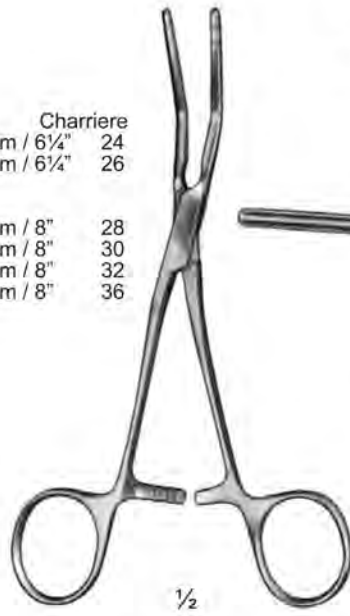

Cooley  
832-07-15 To 832-09-16  
Graduated

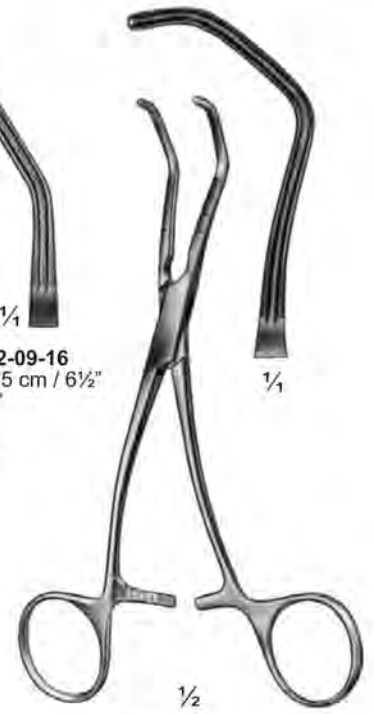

Cooley  
832-10-16  
16 cm / 6 1/4"  
Graduated



Cooley  
832-11-20  
20 cm / 8"



Derra-Cooley  
832-12-17 To 832-14-18  
Graduated

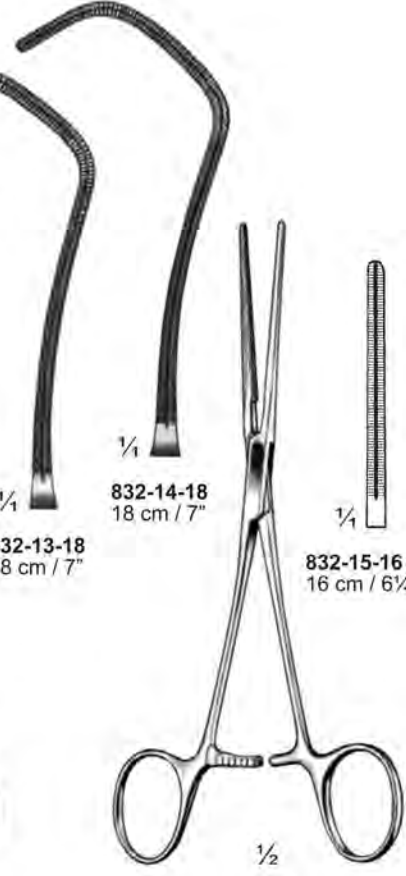

Cooley  
832-15-16 To 832-17-21

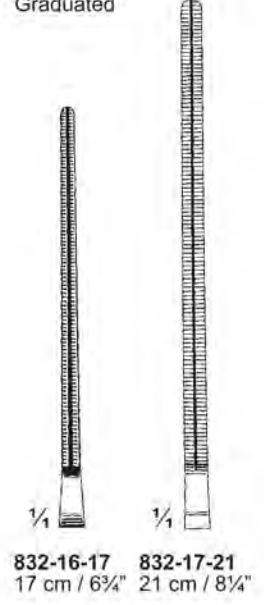

832-12-17  
17 cm / 6 3/4"

832-13-18  
18 cm / 7"

832-14-18  
18 cm / 7"

832-15-16  
16 cm / 6 1/4"

832-16-17  
17 cm / 6 3/4"

832-17-21  
21 cm / 8 1/4"

**Mehrzweck-Gefäßklemmen**  
**Atrauma Cardiovascular Forceps**  
**Pinces vasculaires universelles**

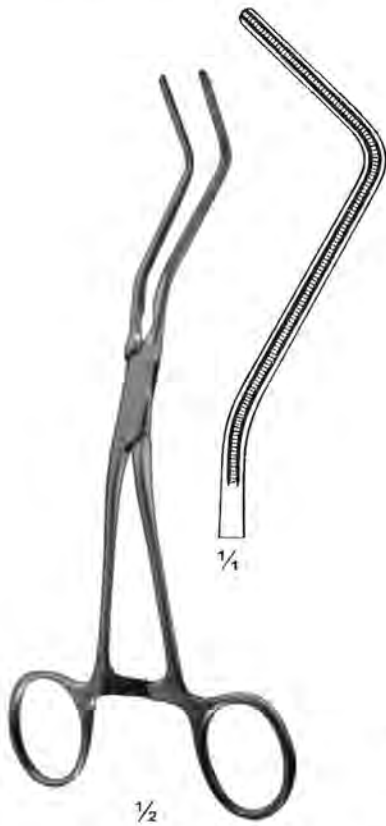

**833-01-19**  
 19.5 cm / 7 3/4"

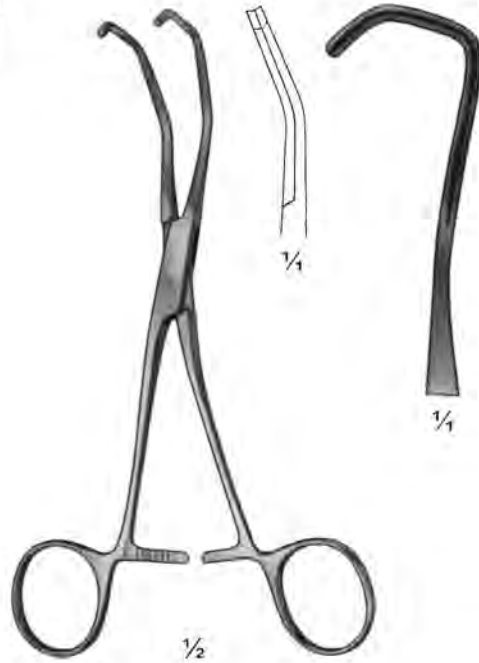

Cooley  
**833-02-17**  
 17 cm / 6 3/4"

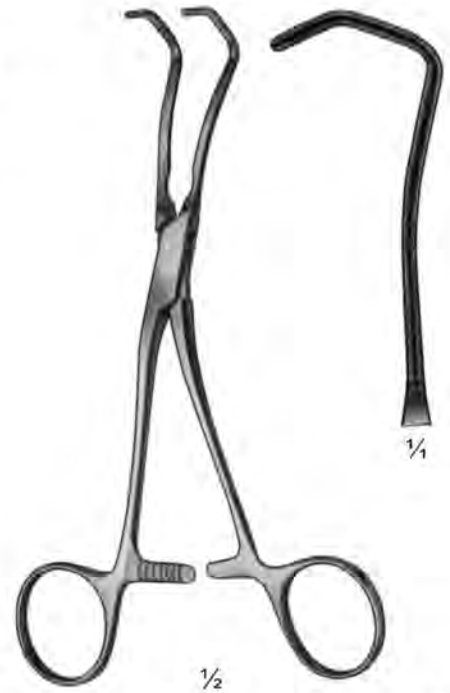

Cooley  
**833-03-18**  
 18 cm / 7"

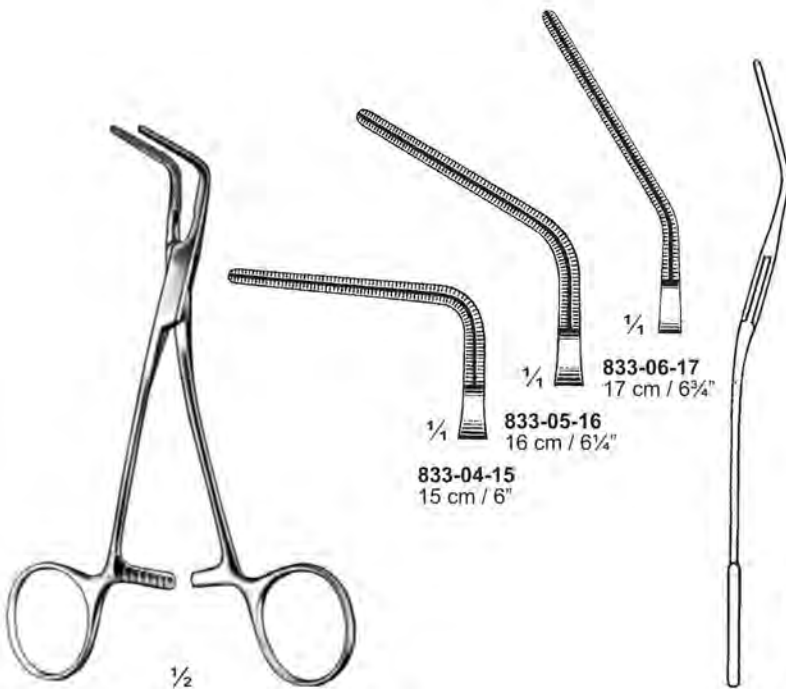

Cooley  
**833-04-15 To 833-06-17**

**833-04-15**  
 15 cm / 6"

**833-05-16**  
 16 cm / 6 1/4"

**833-06-17**  
 17 cm / 6 3/4"

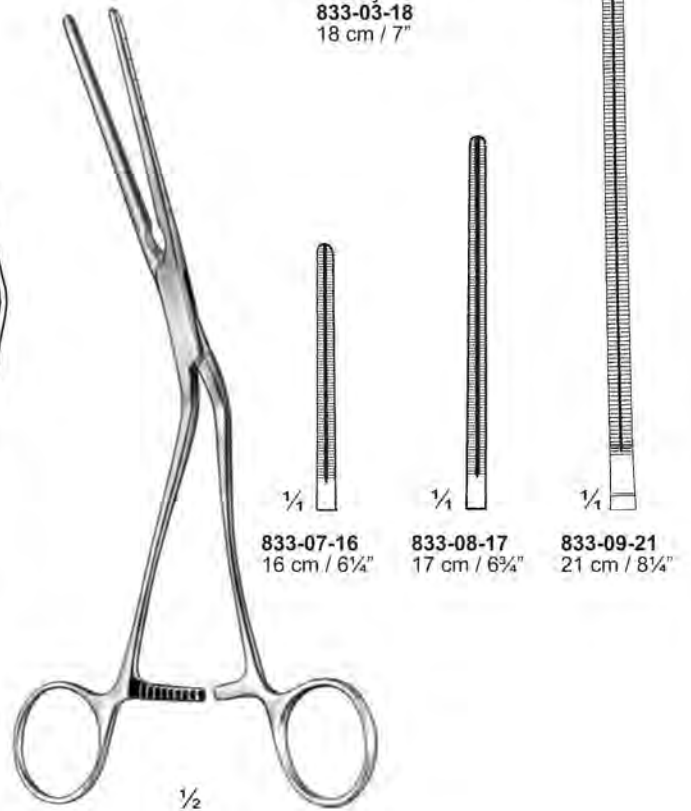

Cooley  
**833-07-16 To 833-09-21**

**833-07-16**  
 16 cm / 6 1/4"

**833-08-17**  
 17 cm / 6 3/4"

**833-09-21**  
 21 cm / 8 1/4"

Mehrzweck-Gefäßklemmen  
 Atrauma Cardiovascular Forceps  
 Pincers vasculaires universelles



Cooly  
 834-01-19  
 19 cm / 7½"



Cooly  
 834-02-16 & 834-03-17

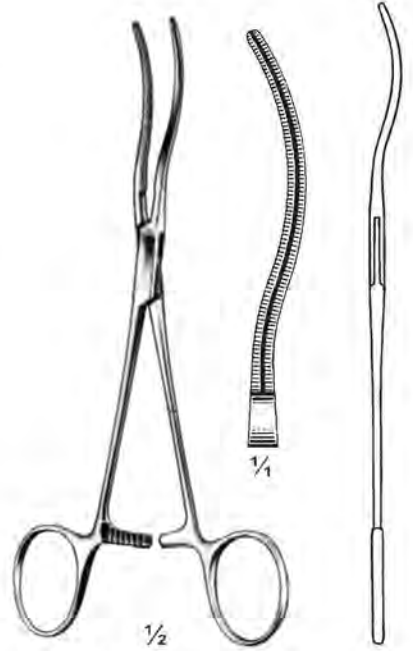

Cooly  
 834-04-17  
 17 cm / 6¾"

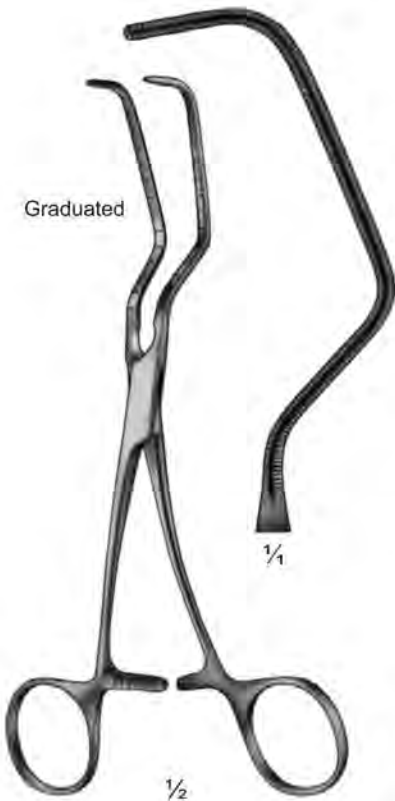

Parry-Cooley  
 834-05-18  
 18.5 cm / 7¼"

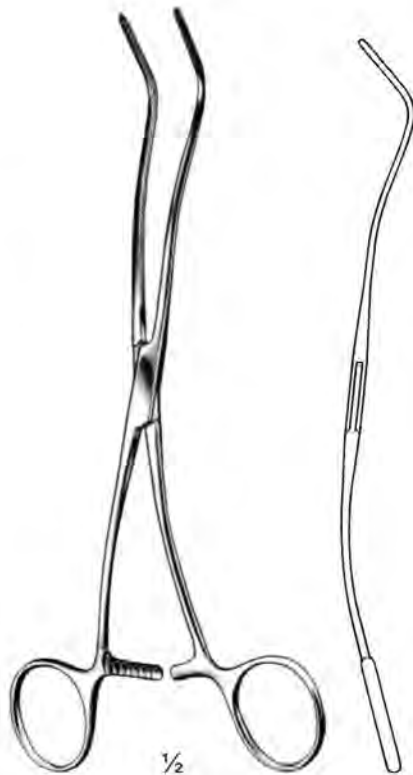

Cooly  
 834-06-18 To 834-08-26

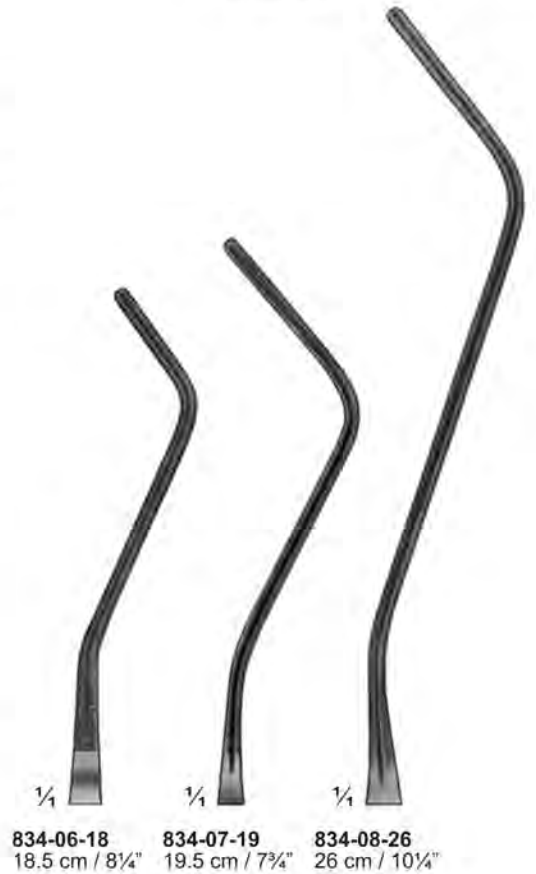

834-06-18 18.5 cm / 8¼"  
 834-07-19 19.5 cm / 7¾"  
 834-08-26 26 cm / 10¼"

**Mehrzweck-Gefäßklemmen**  
**Atrauma Cardiovascular Forceps**  
**Pinces vasculaires universelles**

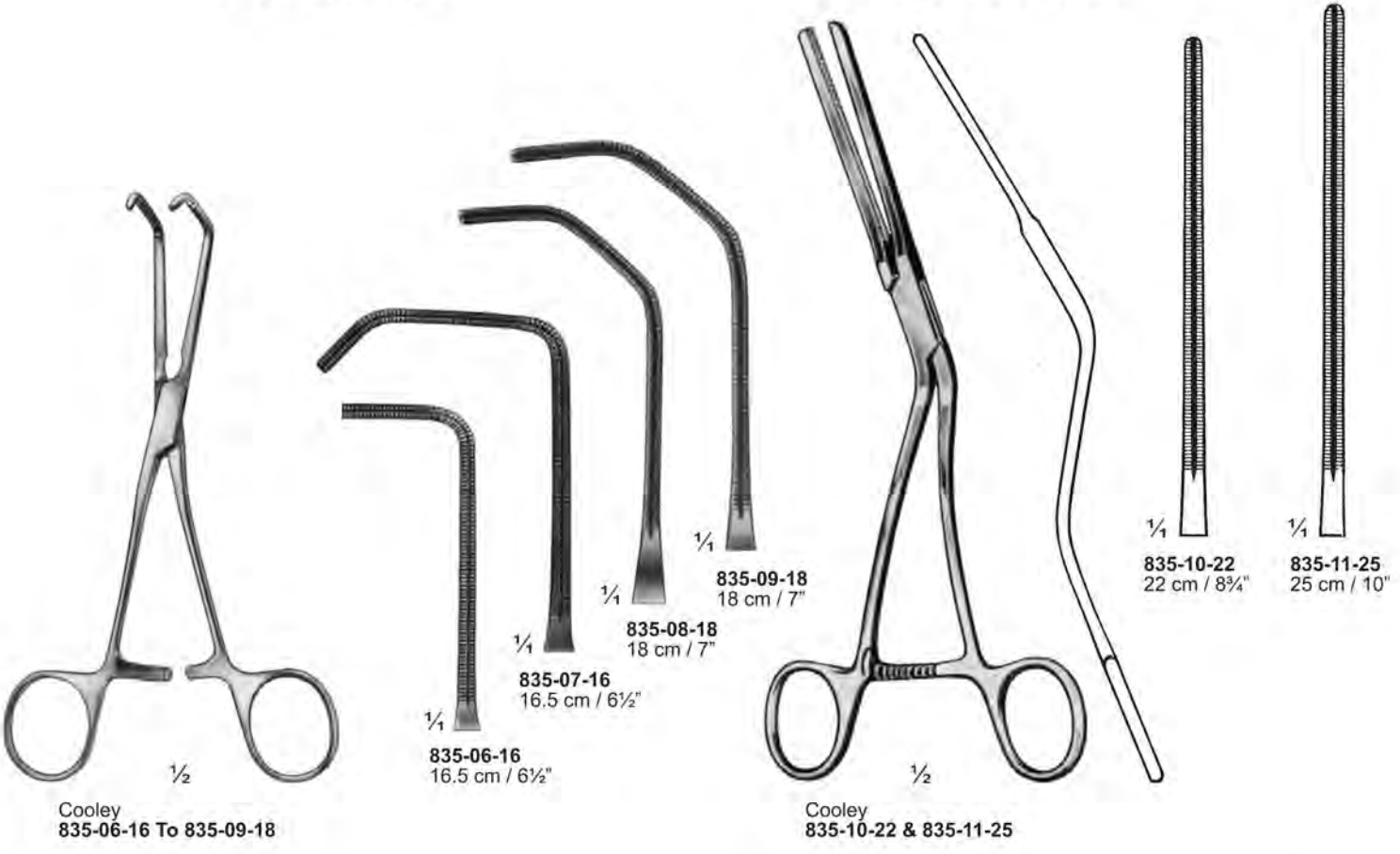
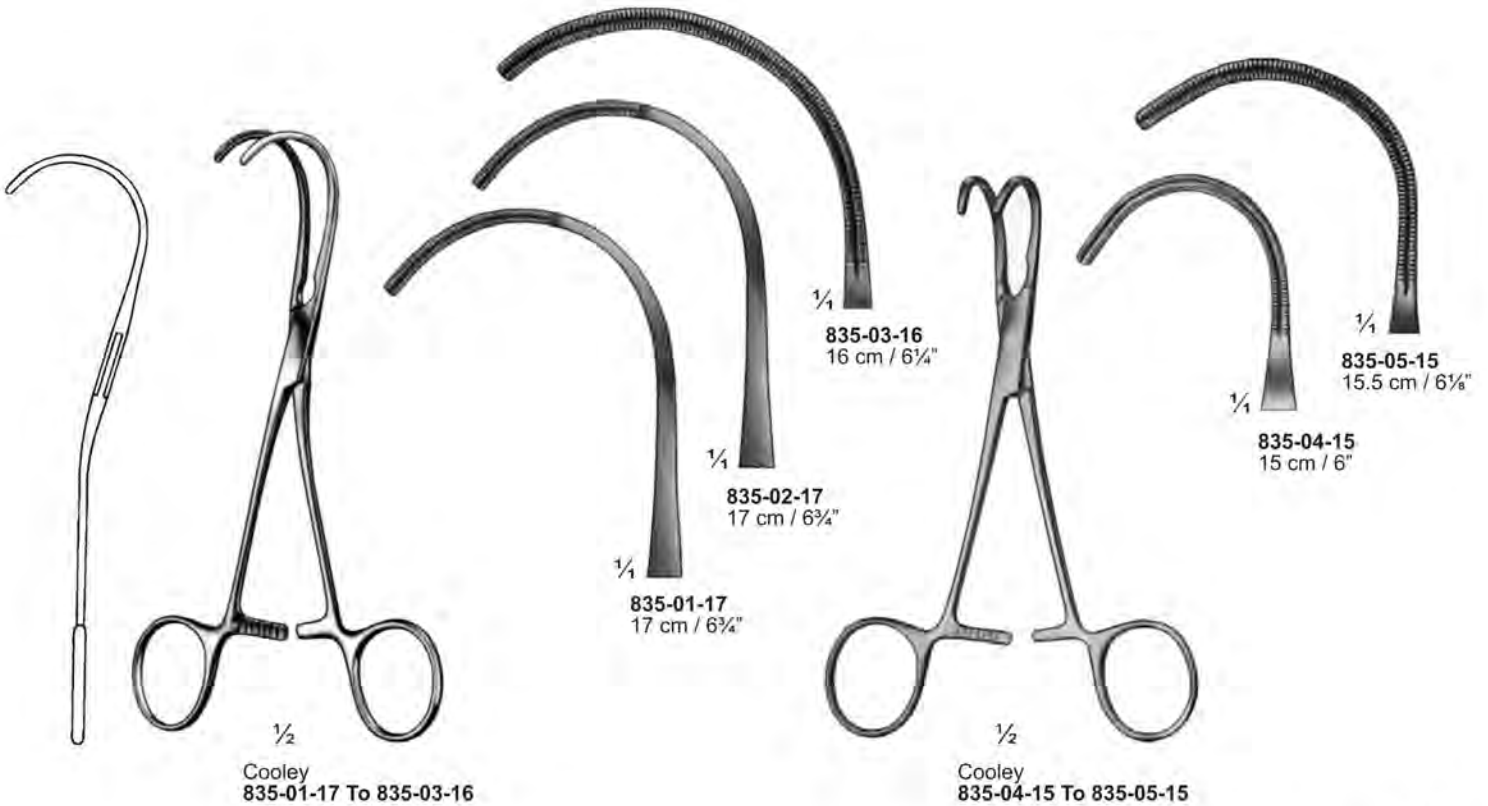

Mehrzweck-Gefäßklemmen  
 Atrauma Cardiovascular Forceps  
 Pincés vasculaires universelles



836-01-16 To 836-04-18



Cooley-Glassman  
 836-05-24  
 24 cm / 9 1/2"



Cooley-Glassman  
 836-06-24  
 24 cm / 9 1/2"

**Mehrzweck-Gefäßklemmen**  
**Atrauma Cardiovascular Forceps**  
**Pinces vasculaires universelles**



1/4



1/2

Werthiem  
837-01-25  
25 cm / 10"



1/2

Dick  
837-02-25 To 837-04-27

1/4

837-02-25  
25 cm / 10"

1/4

837-03-26  
26.5 cm / 10 1/2"

1/4

837-04-27  
27.5 cm / 10 3/4"



1/4



1/2

Subramanian-Miniature  
837-05-15  
15 cm / 6"



1/2

Subramanian-Miniature  
837-06-16 & 837-07-16  
16 cm / 6 1/4"

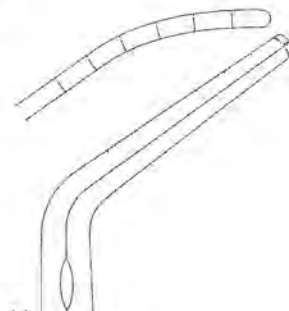

1/4

837-06-16  
Right

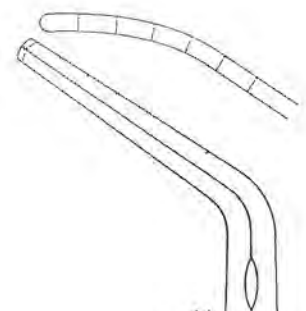

1/4

837-07-16  
Left

**Kinder-Gefäßklemmen, Neonatal-Gefäßklemmen**  
**Pediatric Vascular Clamps, Neonatal Vascular Clamps**  
**Pincès Vasculaires pédiatriques, Pincès Vasculaires pour nouveaux nés**



838-01-12  
12.5 cm / 5"

838-02-11  
11.5 cm / 4½"

Cooley  
838-01-12 To 838-02-11



Cooley  
838-03-10  
10 cm / 4"



Cooley  
838-04-12  
12.5 cm / 5"

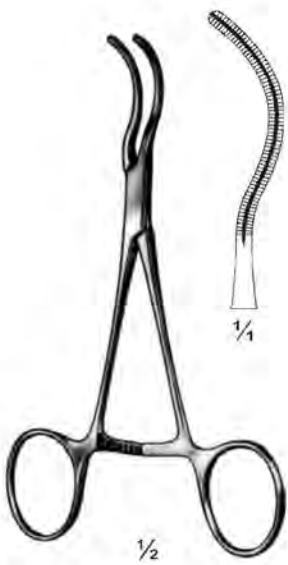

Cooley  
838-05-14  
14 cm / 5½"



Cooley  
838-06-12 To 638-09-12

838-06-12  
12.5 cm / 5"  
30°

838-07-12  
12 cm / 4¾"  
40°

838-08-12  
12.5 cm / 5"

838-09-12  
12.5 cm / 5"



Cooley  
838-10-12 To 638-11-11  
Graduated

838-10-12  
12 cm / 4¾"

838-11-11  
11.5 cm / 4½"



**Kinder-Gefäßklemmen, Neonatal-Gefäßklemmen**  
**Pediatric Vascular Clamps, Neonatal Vascular Clamps**  
**Pincès Vasculaires pédiatriques, Pincès Vasculaires pour nouveaux nés**

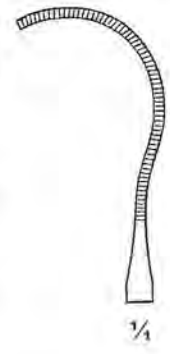
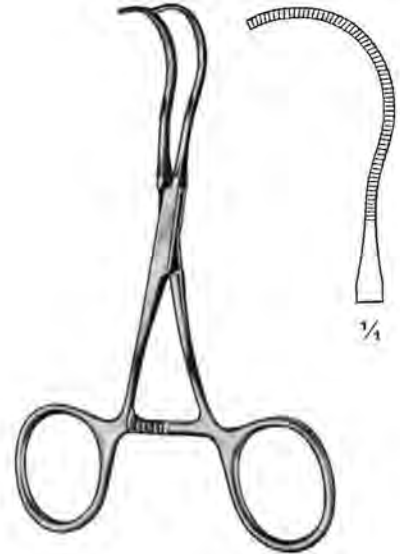
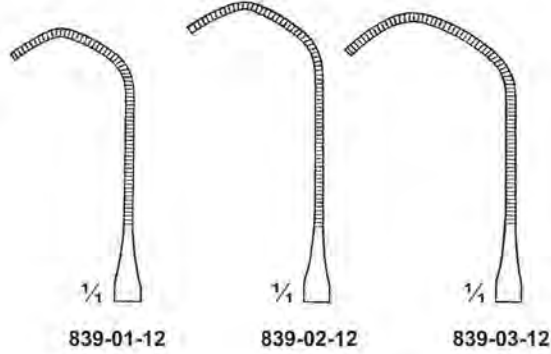

Cooley  
**839-01-12 To 839-03-12**  
 12 cm / 4 3/4"

Cooley  
**839-04-12**  
 12 cm / 4 3/4"

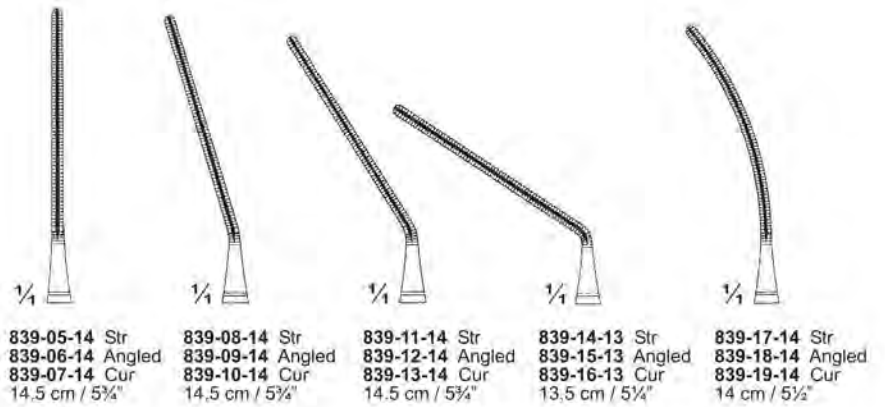
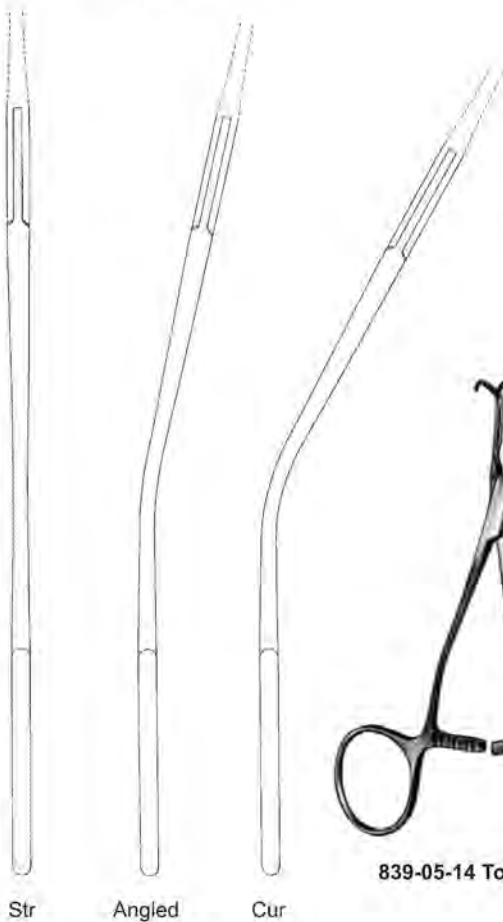

**839-05-14 To 839-31-13**

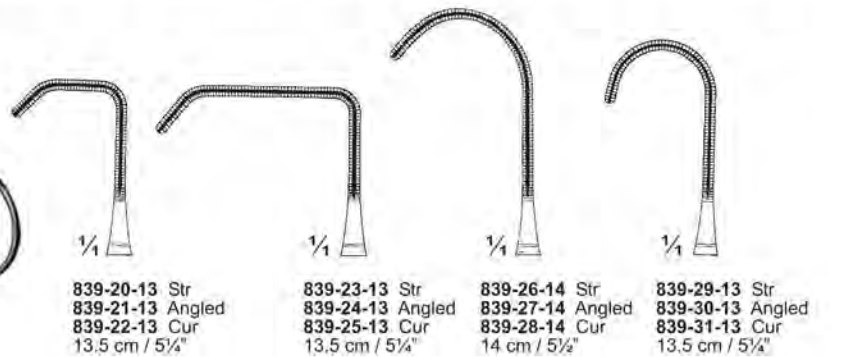



**Kinder-Gefäßklemmen, Neonatal-Gefäßklemmen  
 Pediatric Vascular Clamps, Neonatal Vascular Clamps  
 Pincettes Vasculaires pédiatriques, Pincettes Vasculaires pour nouveaux nés**

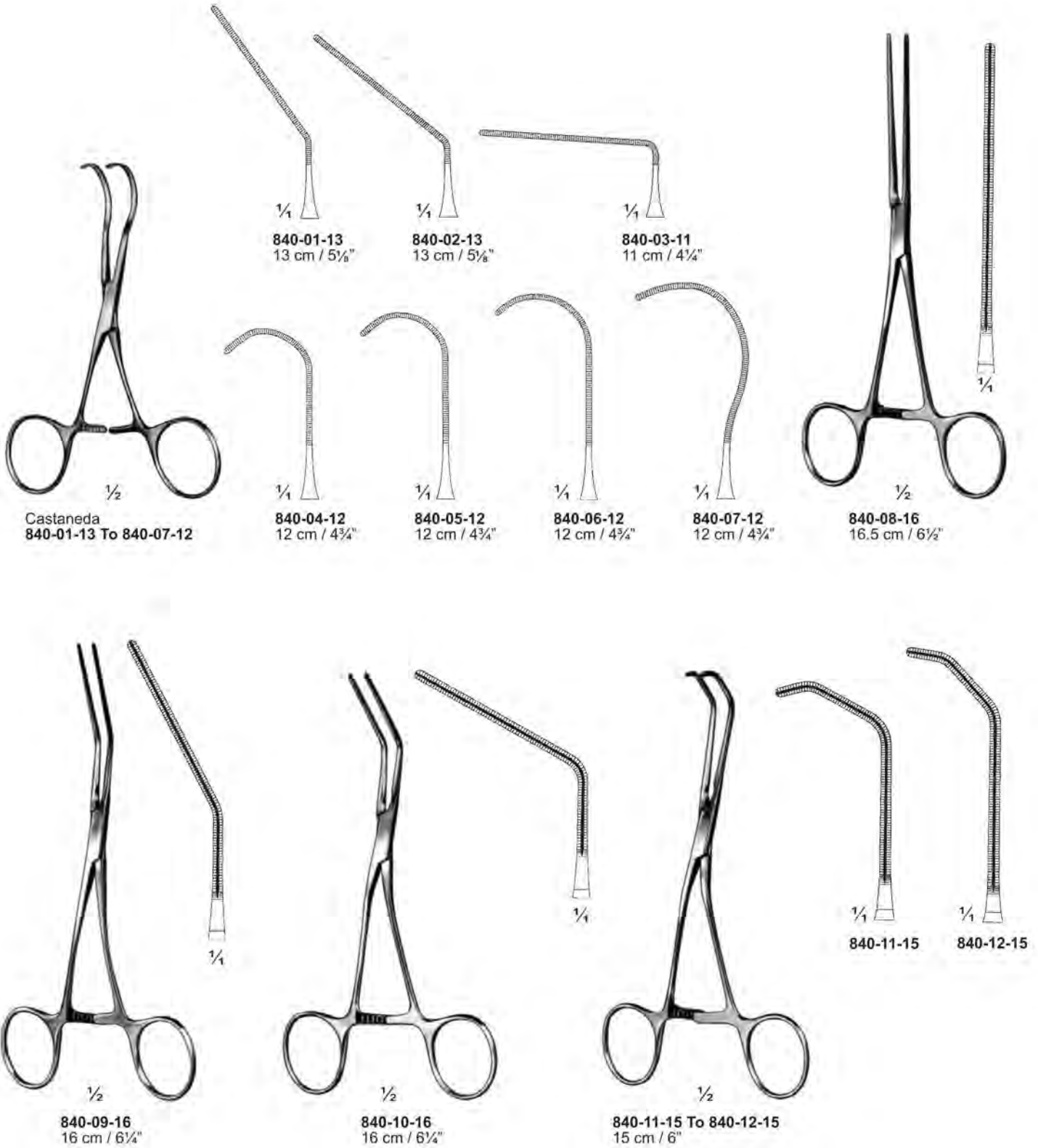

**Nerv Hakt Und Aorten Klammern Fest  
Nerve Hooks And Aorta Clamps  
Le Nerf Accroche Et Les Serre-joint D'aorte**



Schumaker  
841-01-26 To 841-03-46  
18 cm / 7"

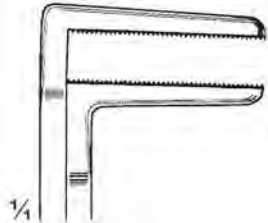

841-01-26  
26 mm

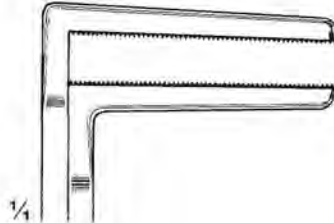

841-02-36  
36 mm

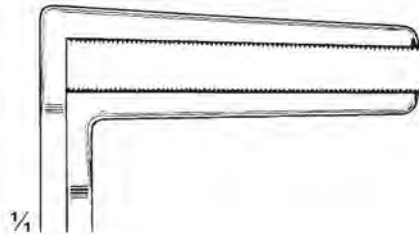

841-03-46  
46 mm



Pappen-Blalock  
841-04-05 5 cm / 2"  
841-05-07 7 cm / 2½"



¼



Hume  
841-06-10  
10 cm / 4"

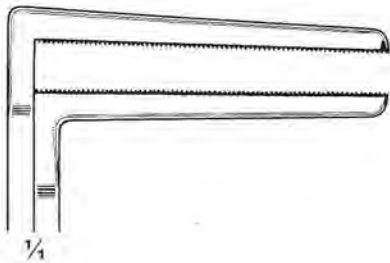

¼



¼



½

841-07-18  
18 cm / 7"  
Vascular measuring  
device

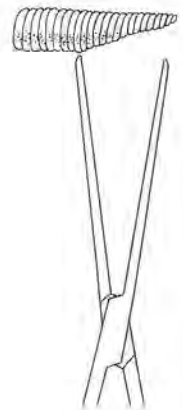

**Gefäßspinzetten**  
**Vascular Forceps**  
**Pincès à dissection vasculaires**

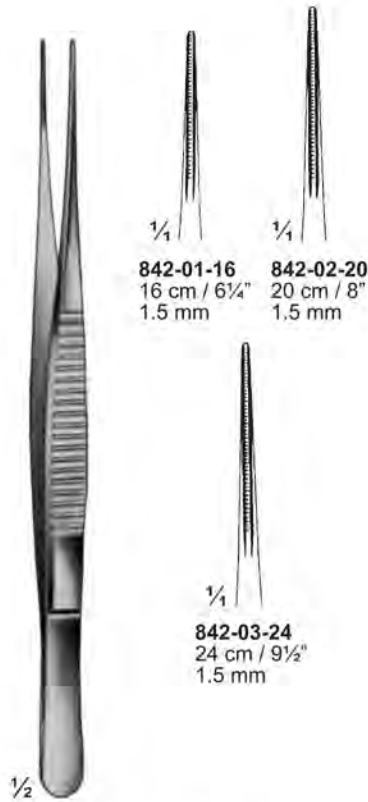

**842-01-16**  
 16 cm / 6¼"  
 1.5 mm

**842-02-20**  
 20 cm / 8"  
 1.5 mm

**842-03-24**  
 24 cm / 9½"  
 1.5 mm

De Bakery  
 842-01-16 To 842-03-24

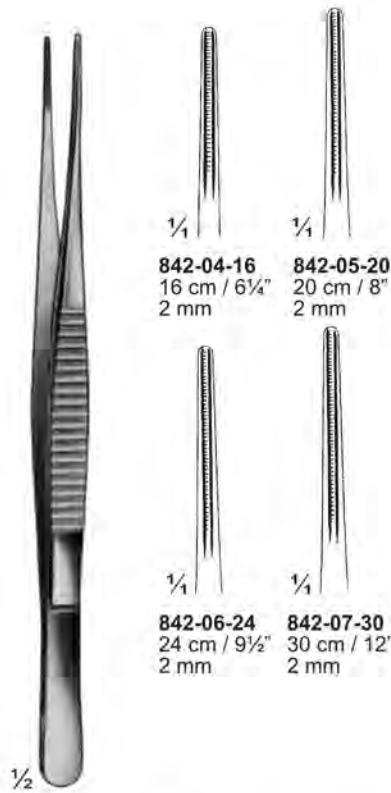

**842-04-16**  
 16 cm / 6¼"  
 2 mm

**842-05-20**  
 20 cm / 8"  
 2 mm

**842-06-24**  
 24 cm / 9½"  
 2 mm

**842-07-30**  
 30 cm / 12"  
 2 mm

De Bakery  
 842-04-16 To 842-07-30

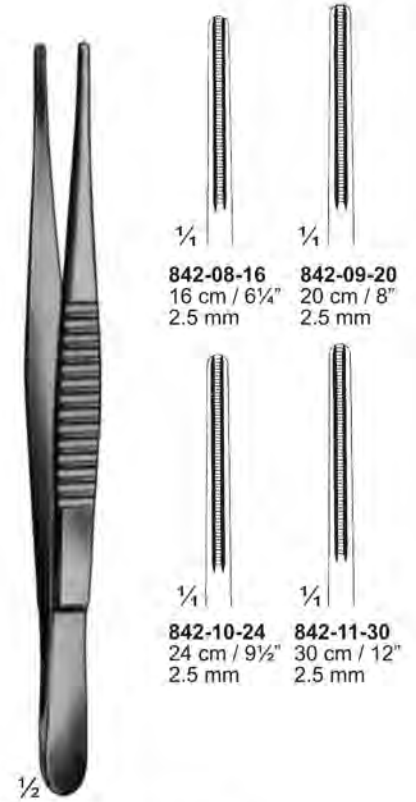

**842-08-16**  
 16 cm / 6¼"  
 2.5 mm

**842-09-20**  
 20 cm / 8"  
 2.5 mm

**842-10-24**  
 24 cm / 9½"  
 2.5 mm

**842-11-30**  
 30 cm / 12"  
 2.5 mm

De Bakery  
 842-08-16 To 842-11-30

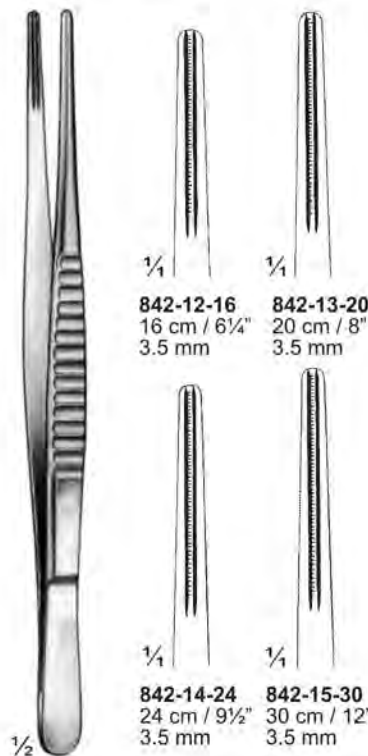

**842-12-16**  
 16 cm / 6¼"  
 3.5 mm

**842-13-20**  
 20 cm / 8"  
 3.5 mm

**842-14-24**  
 24 cm / 9½"  
 3.5 mm

**842-15-30**  
 30 cm / 12"  
 3.5 mm

De Bakery  
 842-12-16 To 842-15-30

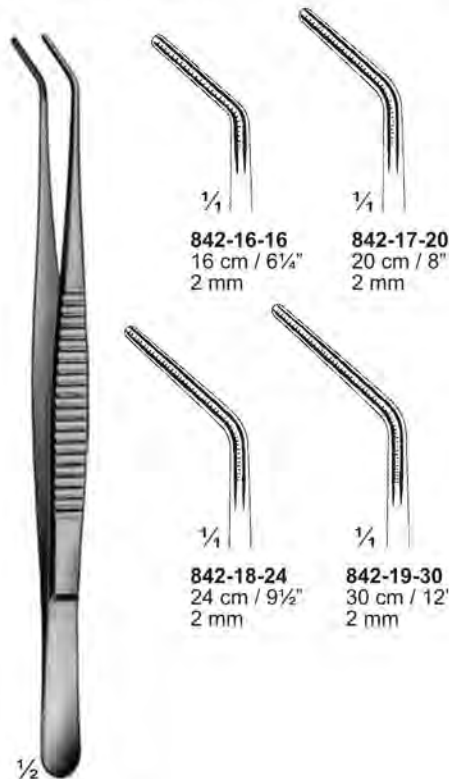

**842-16-16**  
 16 cm / 6¼"  
 2 mm

**842-17-20**  
 20 cm / 8"  
 2 mm

**842-18-24**  
 24 cm / 9½"  
 2 mm

**842-19-30**  
 30 cm / 12"  
 2 mm

De Bakery  
 842-16-16 To 842-19-30

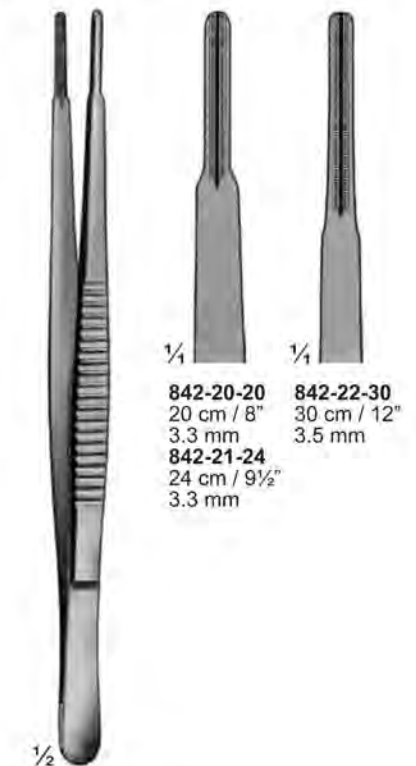

**842-20-20**  
 20 cm / 8"  
 3.3 mm

**842-21-24**  
 24 cm / 9½"  
 3.3 mm

**842-22-30**  
 30 cm / 12"  
 3.5 mm

De Bakery  
 842-20-20 To 842-22-24

**Gefäßpinzetten  
Vascular Forceps  
Pincès à dissection vasculaires**



Cooley  
843-01-16 16 cm / 6¼"  
843-02-20 20 cm / 8"



Glassman  
843-03-15 & 843-04-24



843-03-15 15 cm / 6"  
2 mm  
843-04-24 24 cm / 9½"  
2.5 mm



Glassman  
843-05-24 & 843-06-24

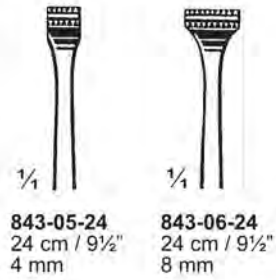

843-05-24 24 cm / 9½"  
4 mm  
843-06-24 24 cm / 9½"  
8 mm

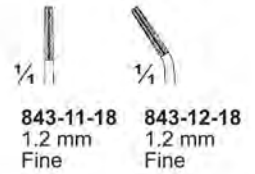

843-11-18 1.2 mm  
Fine  
843-12-18 1.2 mm  
Fine

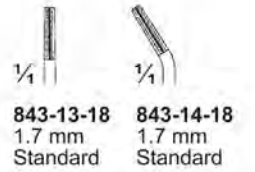

843-13-18 1.7 mm  
Standard  
843-14-18 1.7 mm  
Standard

Item No. 843-11-18 To 843-14-18  
also available in Titanium

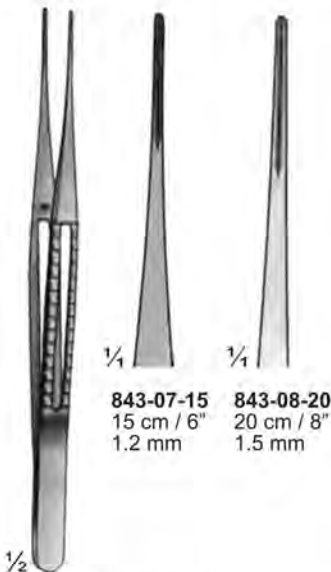

843-07-15 & 843-08-20



843-09-24 & 843-10-30

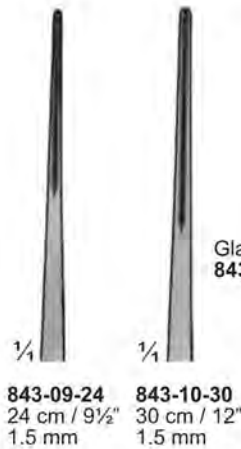

843-09-24 24 cm / 9½"  
1.5 mm  
843-10-30 30 cm / 12"  
1.5 mm



843-11-18 To 843-14-18  
18 cm / 7"

**Aorta-Dilatatoren, Gefäßdilatatoren  
Aortic Dilators, Vascular Dilators  
Dilatateurs pour aorte, Dilatateurs vasculaires**



1/4

1/2

Tube  
**844-01-42**  
Blade opening 8 to 42 mm  
For mitral valve

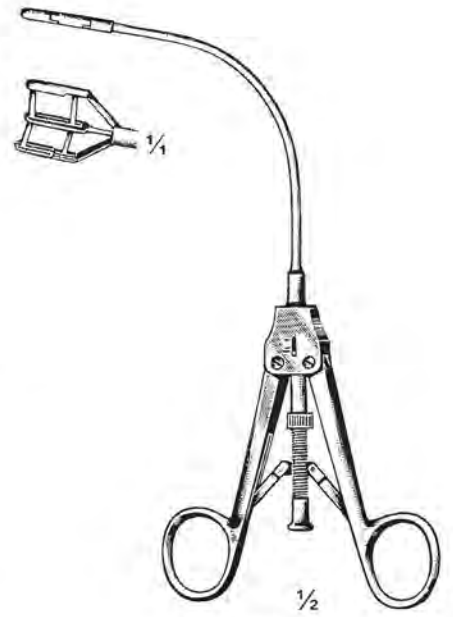

1/2

Cooley  
**844-02-10**  
Blade opening 4 to 10 mm  
For children

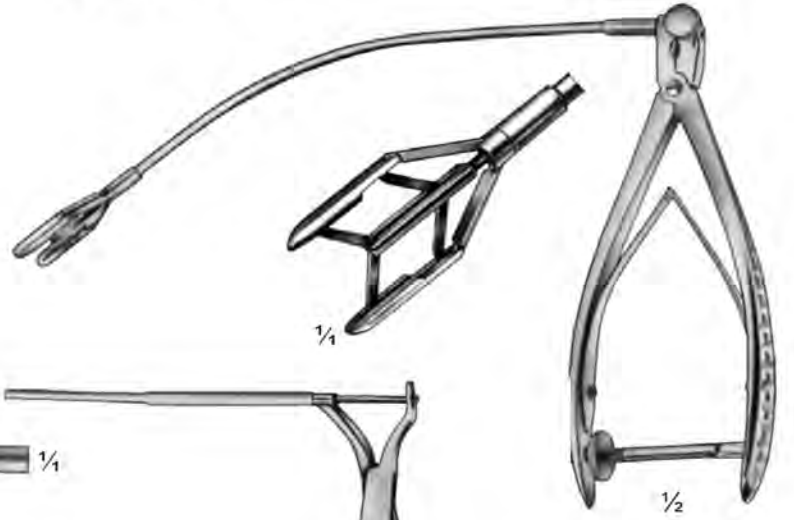

1/4

1/2

Cooley  
**844-03-15**  
Blade opening 8 to 15 mm  
For mitral valve (Pediatric)

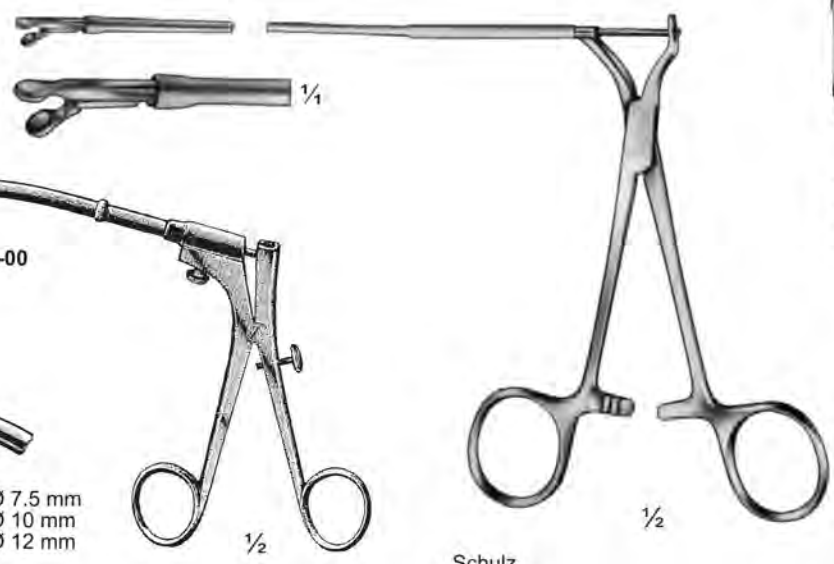

1/2

Schulz  
**844-09-51**  
Shaft length 51 cm / 20 1/4"  
Biopptome with flexible shaft, round jaws Ø 3 mm

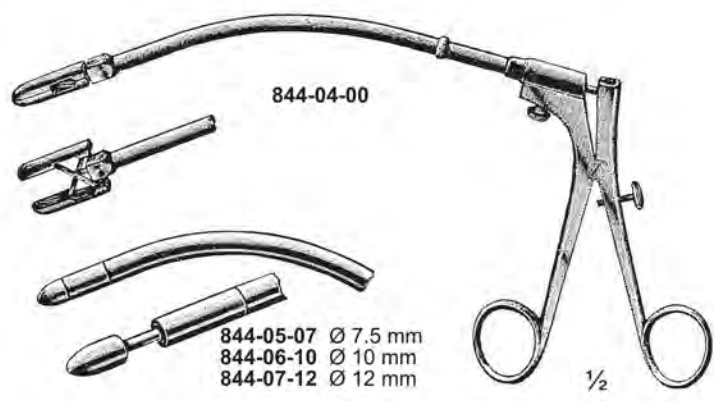

**844-04-00**

- 844-05-07 Ø 7.5 mm
- 844-06-10 Ø 10 mm
- 844-07-12 Ø 12 mm

1/2

Brock  
**844-04-00 To 844-07-12**  
**844-08-04** Complete set with 4



**Aorta-Dilatatoren, Gefäßdilatatoren  
Aortic Dilators, Vascular Dilators  
Dilatateurs pour aorte, Dilatateurs vasculaires**

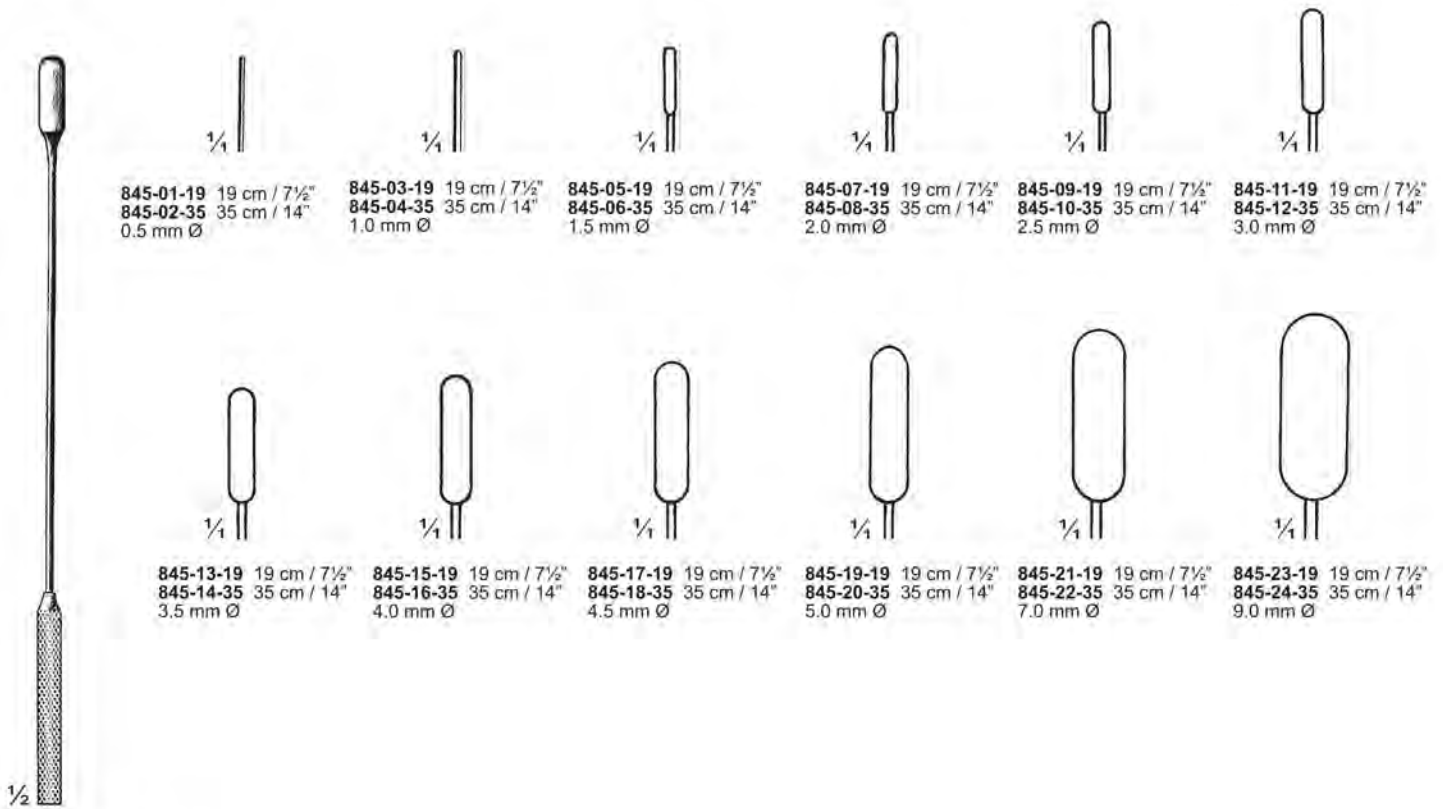

De Bakey  
845-01-19 To 845-24-35  
Malleable

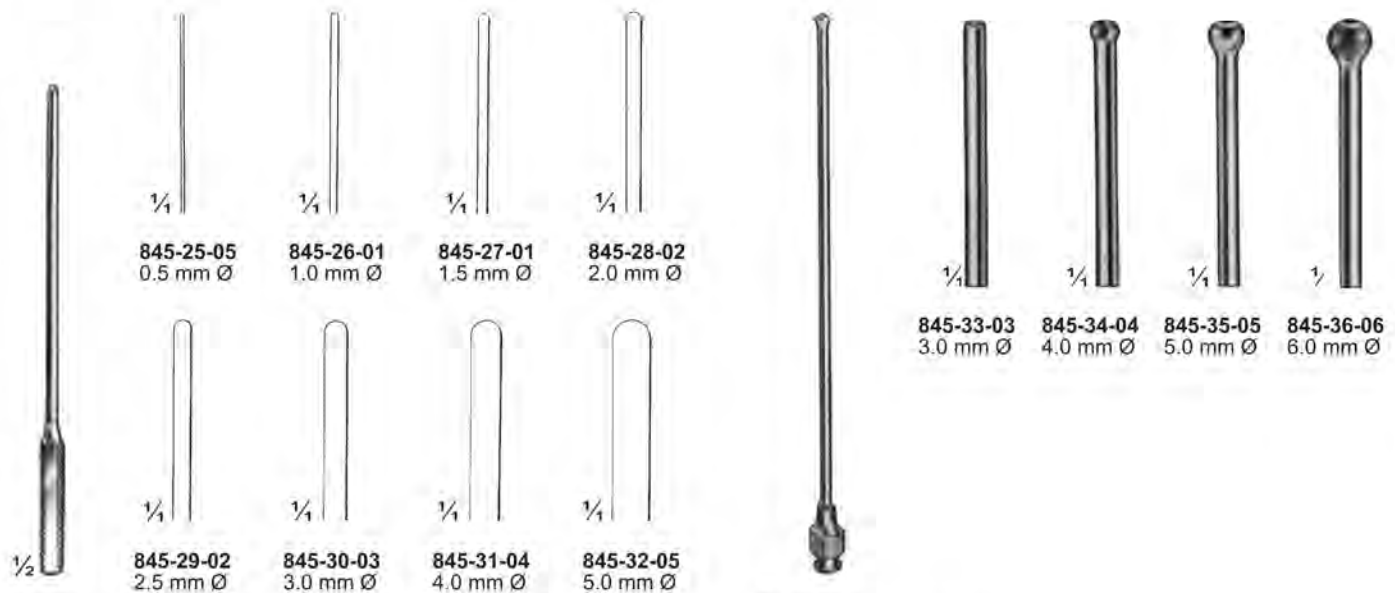

Cooley  
845-25-05 To 845-32-05  
13 cm / 5¼"  
Malleable

Schmid  
845-33-03 To 845-36-06  
15 cm / 6"  
Malleable, silver plated  
Vessel irrigating canulas



**Tunneling Instruments  
Tunneling Instruments  
Creuser Un Tunnel Des Instruments**



1/4



**De Bakey  
846-01-50  
50 cm / 20"**



**846-02-00  
Universal handle**



**846-03-22  
22.5 cm / 8 3/4"  
Tunneling shaft**



**846-04-22  
22.5 cm / 8 3/4"  
Tunneling shaft**



**846-05-54  
54 cm / 21 1/2"  
Tunneling shaft**



**846-12-00  
Complete tunneling set**



**846-06-06  
6 mm  
Bullet Tip**



**846-07-08  
8 mm  
Bullet Tip**



**846-08-10  
10 mm  
Bullet Tip**



**846-09-12  
12 mm  
Bullet Tip**



**846-10-00  
Vein tip**



**846-11-00  
Luer Adaptor**



**Intimaspatel, Gefäßdissektoren**  
**Intima Spatulas, Vascular Dissectors**  
**Spatules pour la tunique interne, Dissecteurs vasculaires**



1/4  
Blunt

847-01-18 18.5 cm / 7 1/2"  
847-02-21 21.5 cm / 8 1/2"

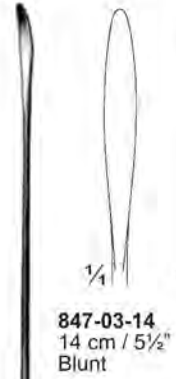

847-03-14  
14 cm / 5 1/2"  
Blunt

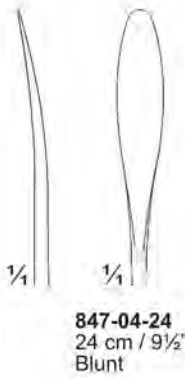

847-04-24  
24 cm / 9 1/2"  
Blunt



Robb  
847-07-25  
25 cm / 10"  
Intima spatula  
and dilator



Robb  
847-08-25  
25 cm / 10"  
Intima spatula  
and dilator



847-09-02 To 847-17-14  
55 cm / 22"  
Enderectomy  
strippers



Robb  
847-05-25  
25 cm / 10"  
Intima spatula  
and dilator



Robb  
847-06-25  
25 cm / 10"  
Intima spatula  
and dilator

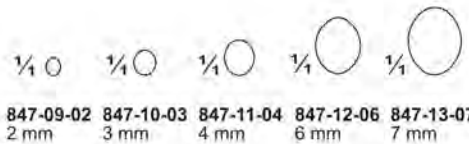

847-09-02 847-10-03 847-11-04 847-12-06 847-13-07  
2 mm 3 mm 4 mm 6 mm 7 mm

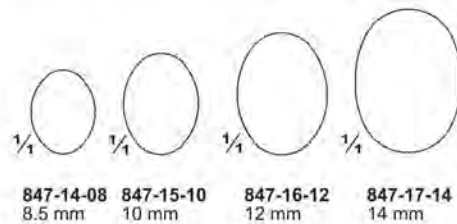

847-14-08 847-15-10 847-16-12 847-17-14  
8.5 mm 10 mm 12 mm 14 mm



847-18-11  
11 cm / 4 1/4"  
Handle for 847-09-02 To  
847-17-14





**Intimaspatel, Gefäßdissektoren**  
**Intima Spatulas, Vascular Dissectors**  
**Spatules pour la tunique interne, Dissecteurs vasculaires**





**Nerv Hakt Und Aorten Klammern Fest**  
**Nerve Hooks And Aorta Clamps**  
**Le Nerf Accroche Et Les Serre-joint D'aorte**

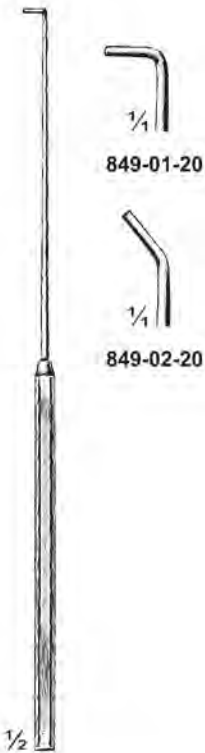

849-01-20

849-02-20

Crile  
 849-01-20 To 849-02-20  
 20 cm / 8"

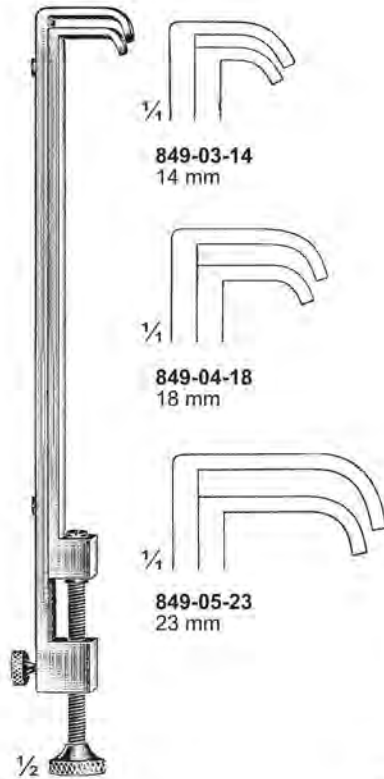

849-03-14  
 14 mm

849-04-18  
 18 mm

849-05-23  
 23 mm

Blalock  
 849-03-14 To 849-05-23  
 20 cm / 8"



849-06-22  
 21 cm / 8 1/4"  
 22 mm

849-07-25  
 26 cm / 10 1/4"  
 25 mm

Blalock  
 849-06-22 To 849-08-32  
 26 cm / 10 1/4"  
 32 mm

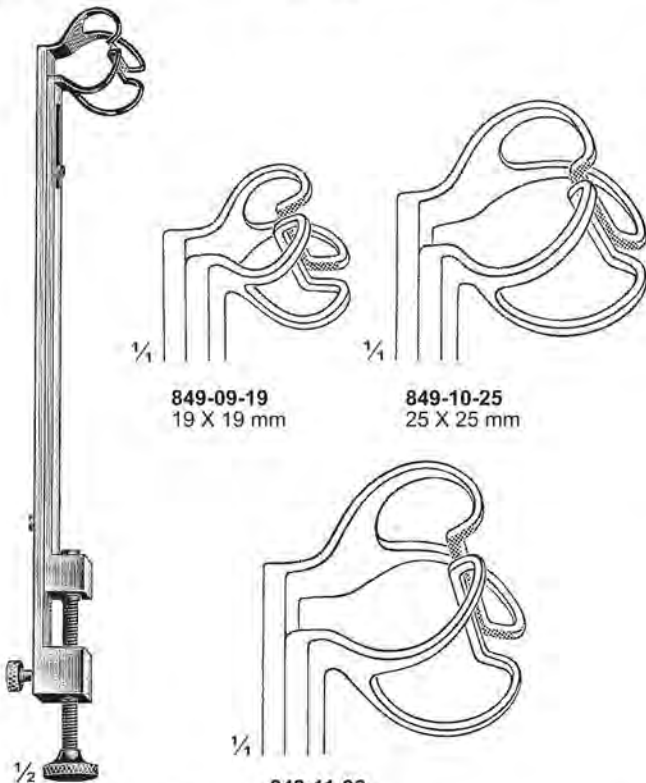

849-09-19  
 19 X 19 mm

849-10-25  
 25 X 25 mm

849-11-32  
 32 X 32 mm

Pott (Johns-Hopkins)  
 849-09-19 To 849-11-32  
 20 cm / 8"

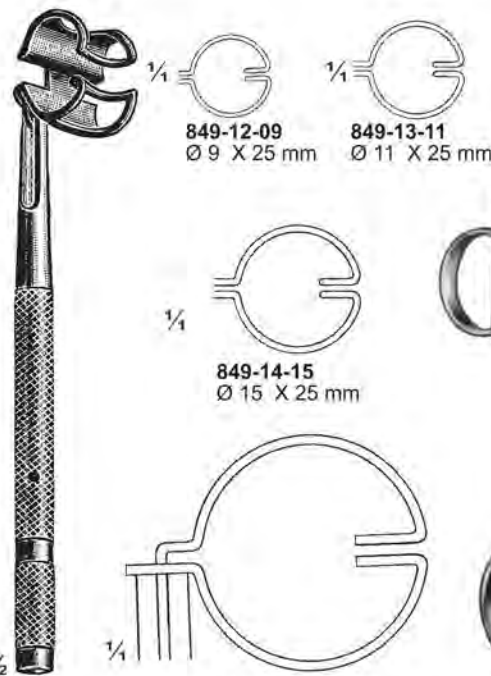

849-12-09  
 Ø 9 X 25 mm

849-13-11  
 Ø 11 X 25 mm

849-14-15  
 Ø 15 X 25 mm

Potts-Smith  
 849-12-09 To 849-15-28  
 18 cm / 7"

849-15-28  
 Ø 28 X 35 mm

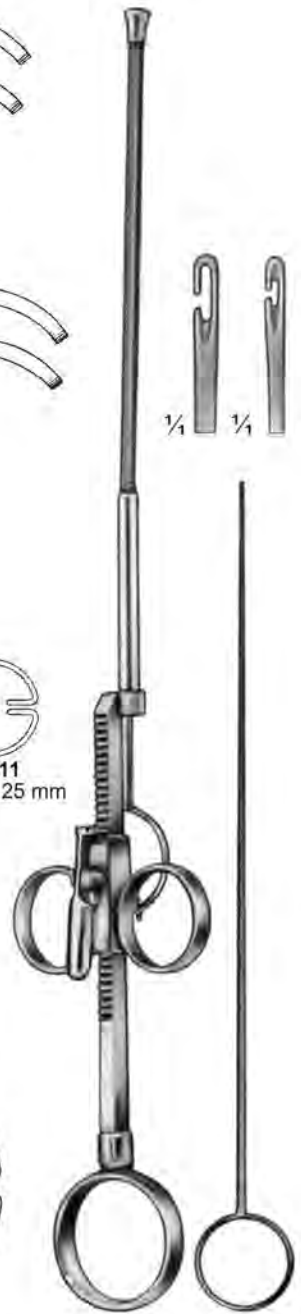

Rumel-Belmont  
 849-16-04 Ø 4 mm  
 849-17-06 Ø 6.4 mm  
 33 cm / 13"  
 With one pair of guide

**Aorten Retraktoren  
Aorta Retractors  
Enrouleurs D'aorte**



Blake  
850-01-20  
20 cm / 8"

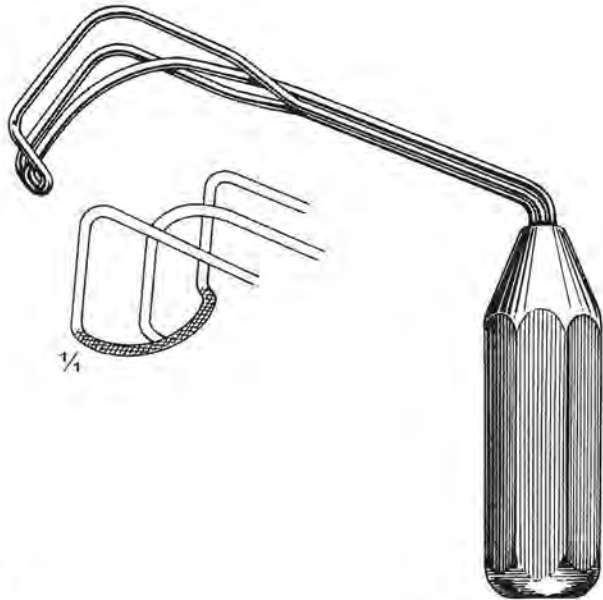

Cooley  
850-02-21  
21.5 cm / 8 1/4"

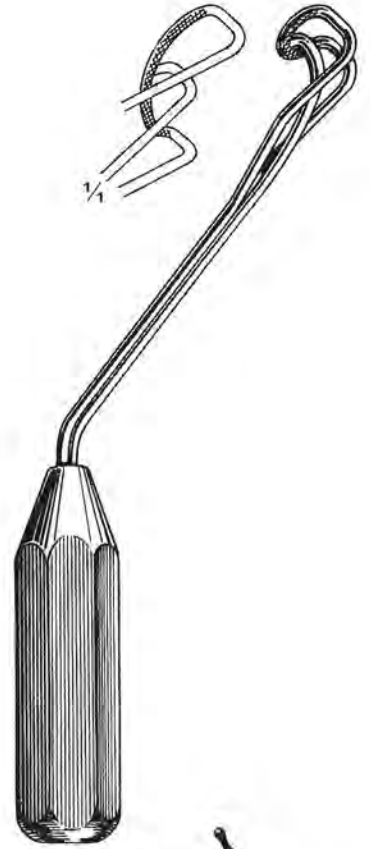

Cooley  
850-03-23  
23 cm / 9"

14 X 17 mm

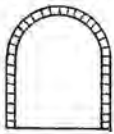

14 X 21 mm

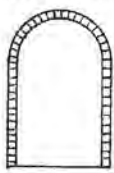

14 X 38 mm

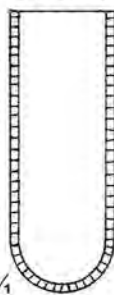

14 X 44 mm

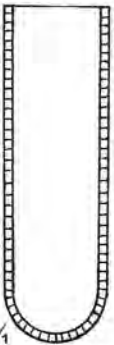

850-04-20

850-05-20



Cooley  
850-04-20 & 850-05-20  
20 cm / 8"



Brock  
850-06-05  
27 cm / 10 1/2"  
Ø 5 mm



Brock  
850-07-06  
27 cm / 10 1/2"  
6 mm



Brock  
850-08-07 7.5 mm  
850-09-10 10 mm  
850-10-12 12 mm  
27 cm / 10 1/2"

**Valvulotomes  
Valvulotomes  
Valvulotomes**

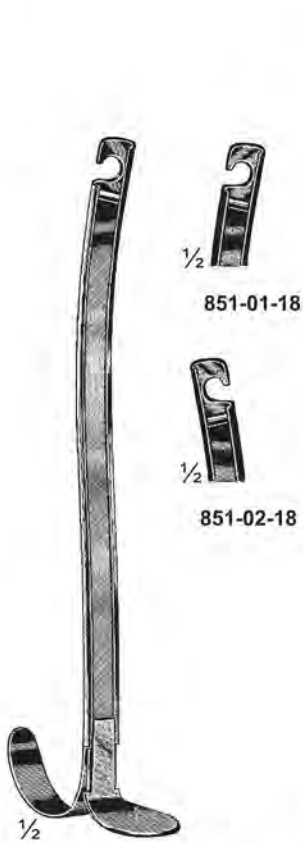

Bailey-Glover-O'Neil  
851-01-18 & 851-02-18  
18 cm / 7"

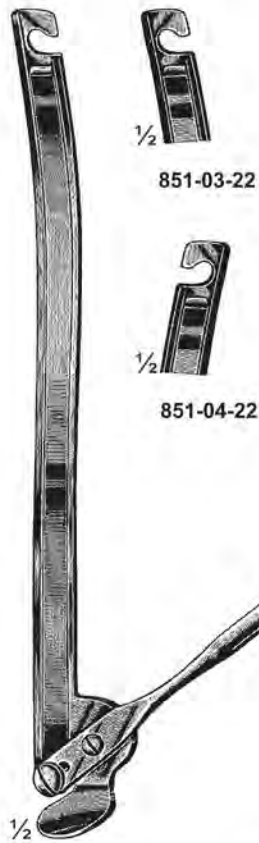

Derra  
851-03-22 & 851-04-22  
22 cm / 8 3/4"

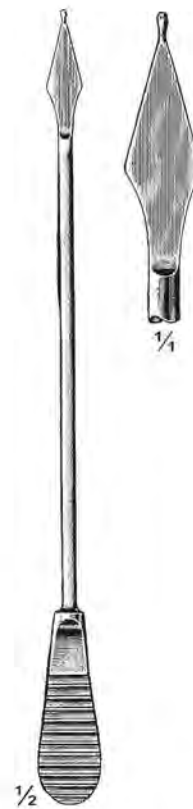

Brock-Bailey  
851-05-21  
21 cm / 8 1/4"



Brock-Bailey  
851-06-21  
21 cm / 8 1/4"



Brock  
851-07-21  
21 cm / 8 1/4"  
Flexible



Brock  
851-08-21  
21 cm / 8 1/4"  
Flexible



Dogliotti  
851-09-27  
27 cm / 10 1/2"  
Flexible



Dogliotti  
851-10-27  
27 cm / 10 1/2"  
Flexible

Gefäß Klammert Fest  
Vessel Clamps  
Le Vaisseau Serre

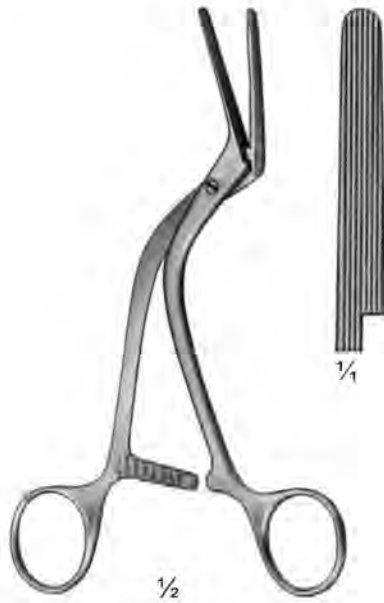

$\frac{1}{2}$   
Hopfner  
852-01-16  
16 cm / 6 $\frac{1}{4}$ "



Baby-Satinsky  
852-02-15  
15 cm / 6"

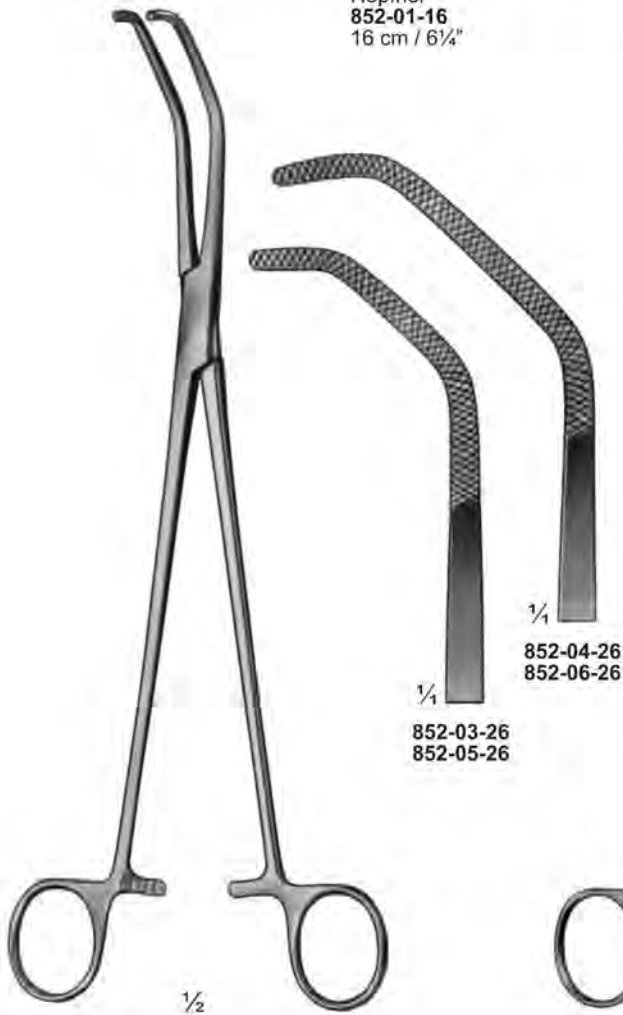

$\frac{1}{2}$   
Satinsky  
852-03-26 & 852-04-26  
26.5 cm / 10 $\frac{1}{2}$ "

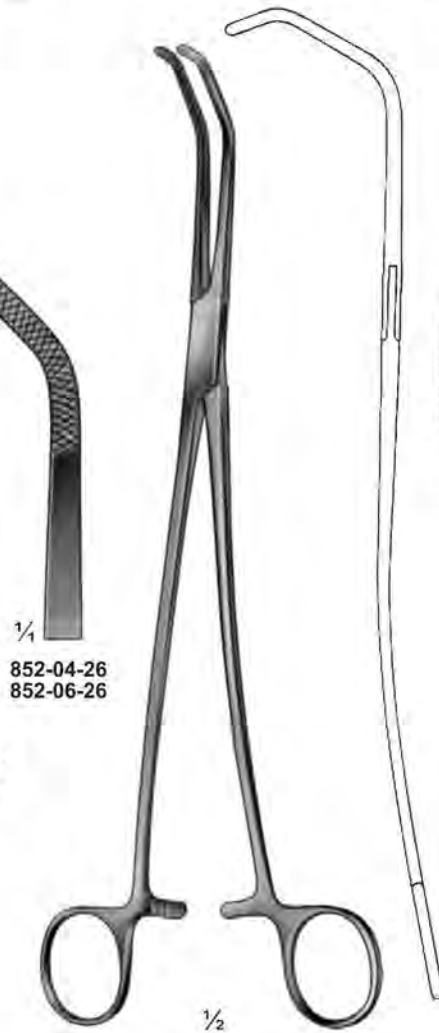

$\frac{1}{2}$   
Satinsky  
852-05-26 & 852-06-26  
26.5 cm / 10 $\frac{1}{2}$ "

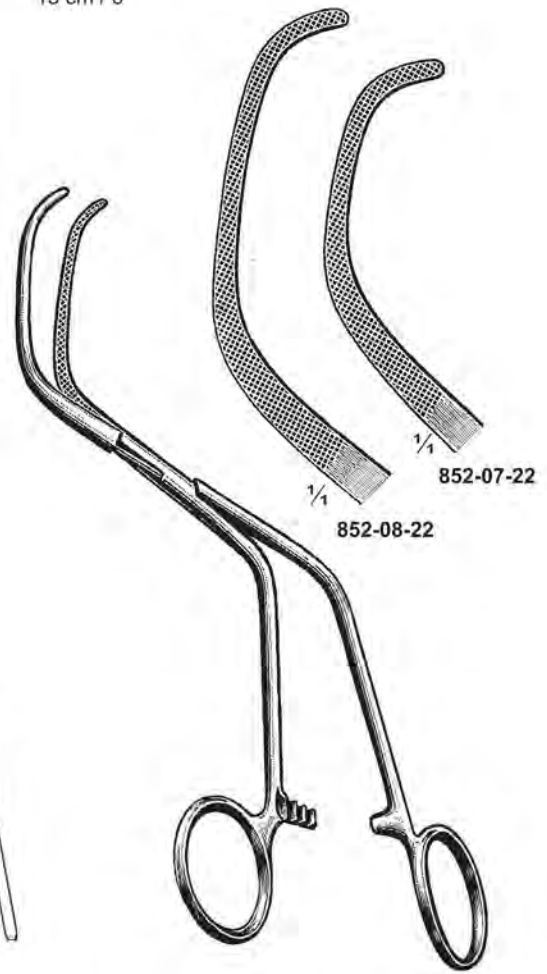

Potts-Satinsky  
852-07-22 & 852-08-22  
22 cm / 8 $\frac{3}{4}$ "

Gefäß Klammert Fest  
 Vessel Clamps  
 Le Vaisseau Serre

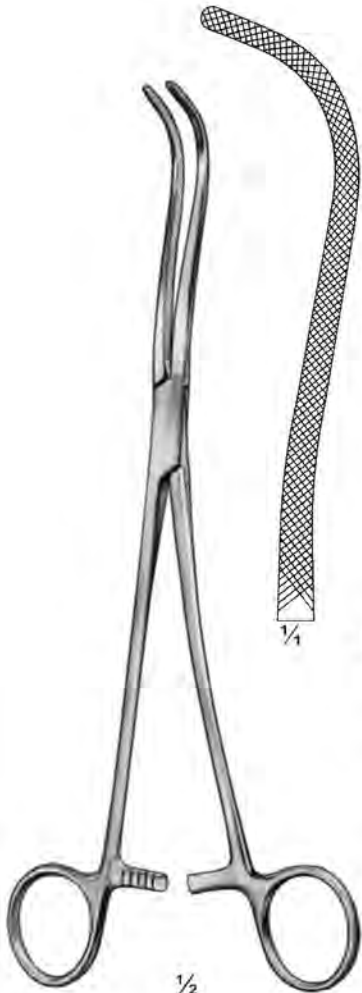

$\frac{1}{2}$   
 Harken  
 853-01-24  
 24 cm / 9½"



$\frac{1}{4}$

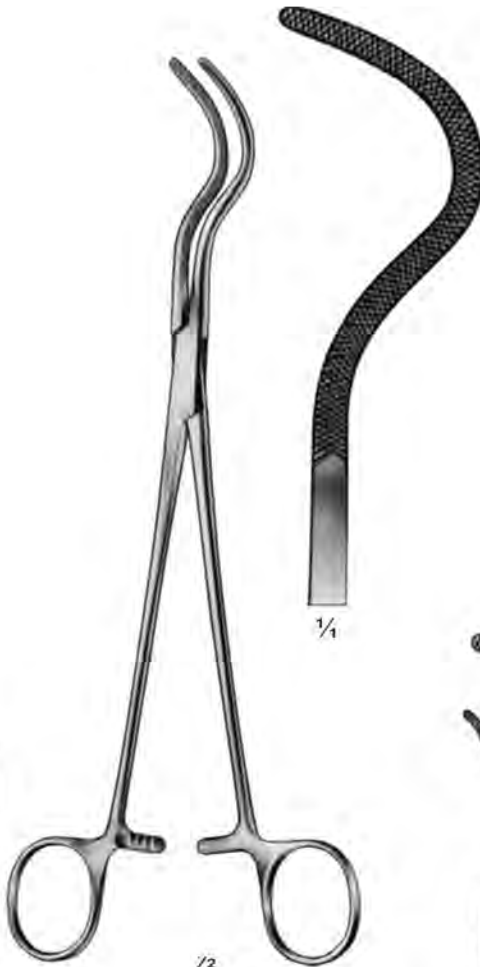

$\frac{1}{2}$   
 Harken  
 853-02-24  
 24 cm / 9½"

$\frac{1}{4}$



$\frac{1}{2}$   
 Harken  
 853-03-24  
 24 cm / 9½"



Item No. 853-03-24 & 853-04-24  
 can be use together



Harken  
 853-04-24  
 24 cm / 9½"

$\frac{1}{4}$

Gefäß Klammert Fest  
Vessel Clamps  
Le Vaisseau Serre

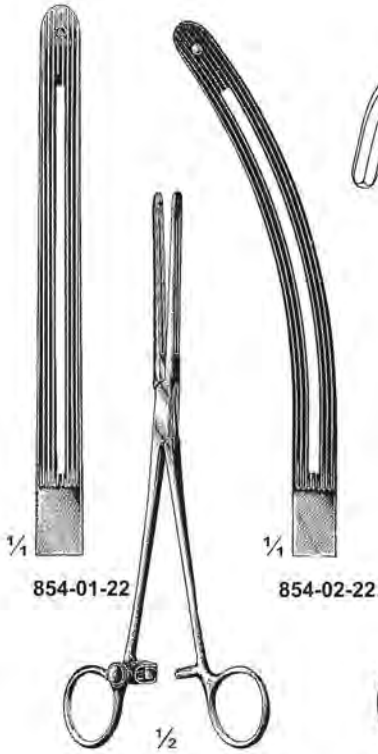

854-01-22      854-02-22

Johns-Hopkins  
854-01-22 & 854-02-22  
22 cm / 8 3/4"

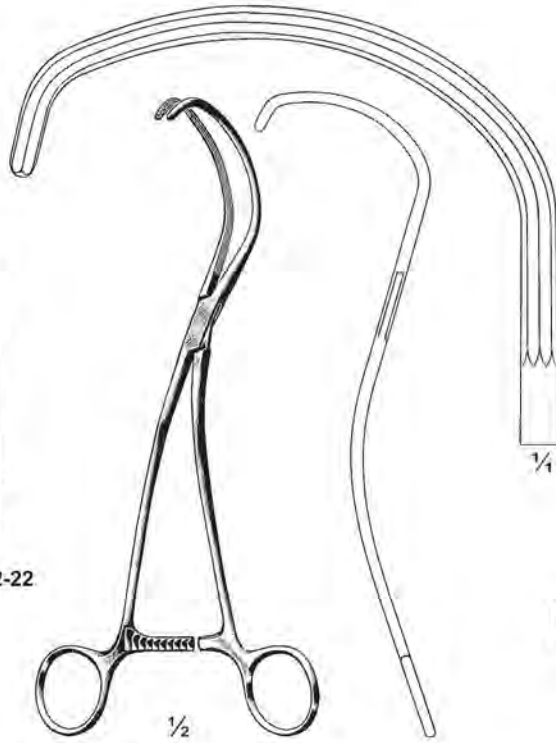

854-03-24

Derra  
854-03-24  
24 cm / 9 1/2"

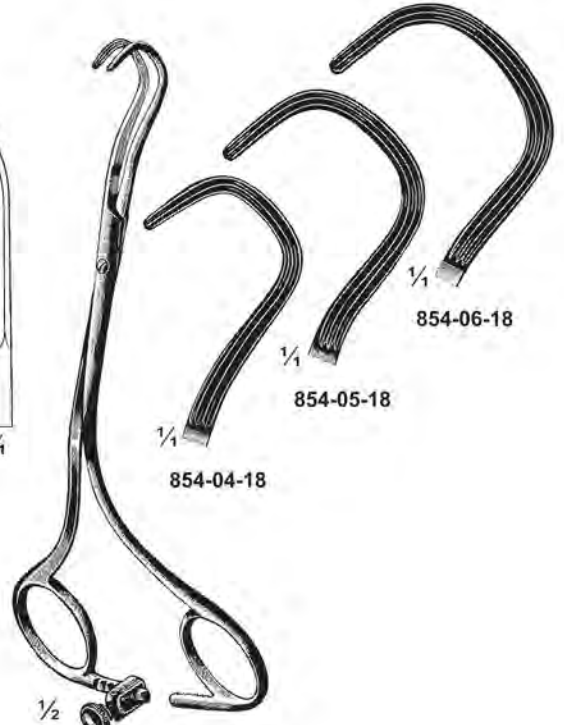

854-04-18 To 854-06-18

Derra  
854-04-18 To 854-06-18  
18 cm / 7"



854-07-20      854-08-22

Potts  
854-07-20 & 854-08-22

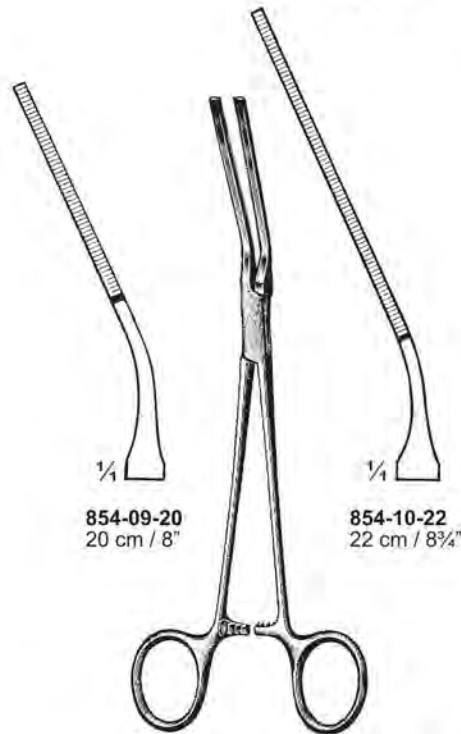

854-09-20      854-10-22

Potts  
854-09-20 & 854-10-22

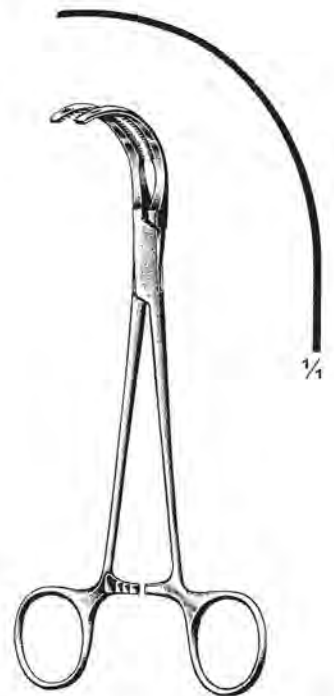

854-11-21

Potts-Glover  
854-11-21  
21 cm / 8 1/4"

**Gefäß Klammert Fest  
Vessel Clamps  
Le Vaisseau Serre**



Potts-Glover  
855-01-22  
22 cm / 8¾"



Potts-Satinsky  
855-02-21  
21 cm / 8¼"



½  
Pertuiset  
855-03-09  
9 cm / 3½"  
Catroid clamp



855-04-18 To 855-05-18  
18.5 cm / 7¼"



855-04-18  
Sh/Probe, 125°



855-05-18  
Sh/Sh, 125°

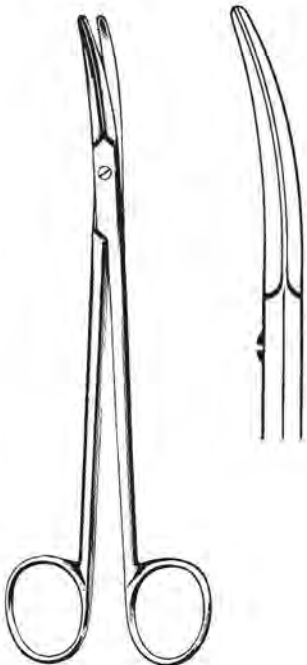

Potts-Smith  
855-06-18  
18 cm / 7"

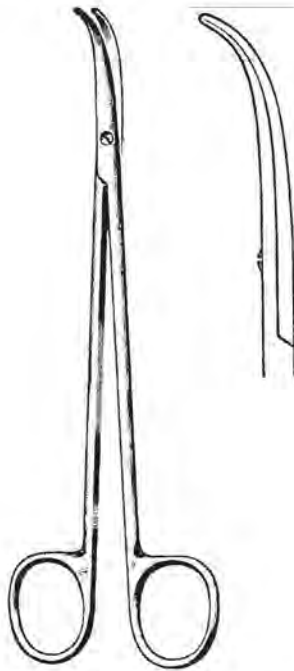

De Bakey  
855-07-18  
18 cm / 7"



855-08-19  
Sh/Sh

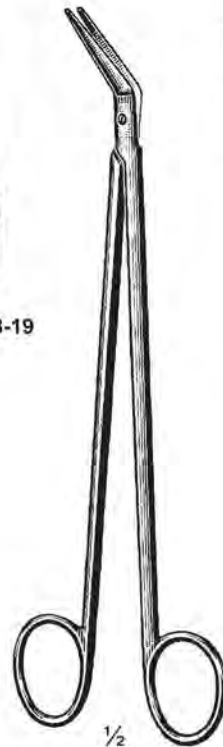

½  
Potts-Smith  
855-08-19 & 855-09-19  
19 cm / 7½"



855-09-19  
Bl/Bl



Ärgern Sie Leitung Zange  
 Gall Duct Forceps  
 Les Forceps De Conduit De Bile



1/2  
 Nissen  
 856-01-21  
 21 cm / 8 1/4"



1/4  
 856-02-21  
 1 X 2 Teeth

1/4  
 856-03-21  
 1 X 2 Teeth

Hosemann  
 856-02-21 & 856-03-21  
 21.5 cm / 8 1/2"

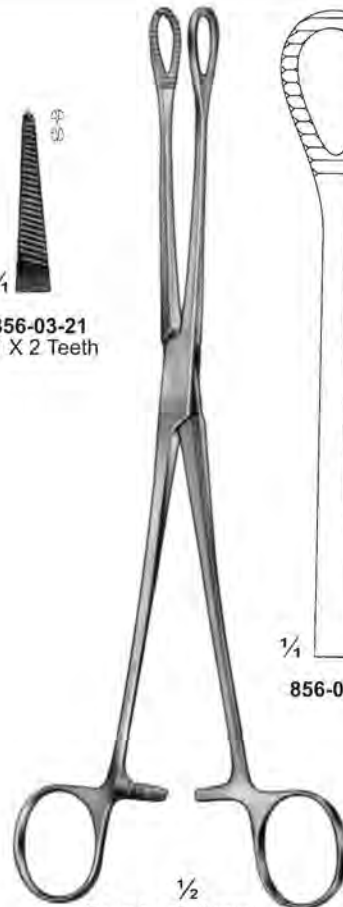

1/2  
 Foerster-Ballenger  
 856-04-24 & 856-05-24  
 24 cm / 9 1/2"

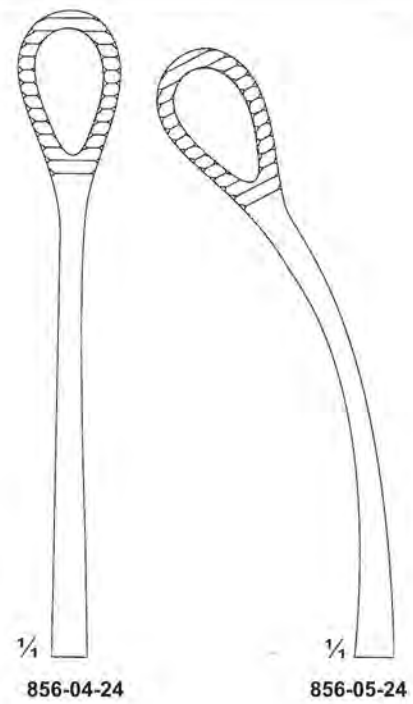

1/2  
 Heywood-Smith  
 856-06-20  
 20 cm / 8"

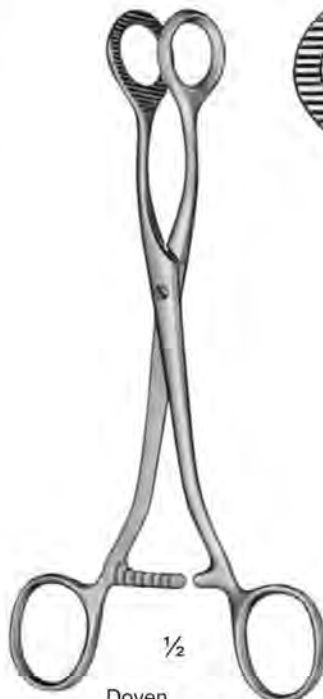

1/4  
 Doyen  
 856-07-18  
 18.5 cm / 8 1/4"



1/2  
 Heywood-Smith modif.  
 856-08-21  
 21.5 cm / 8 1/2"

Ärgern Sie Leitung Zange  
 Gall Duct Froceps  
 Les Forceps De Conduit De Bile

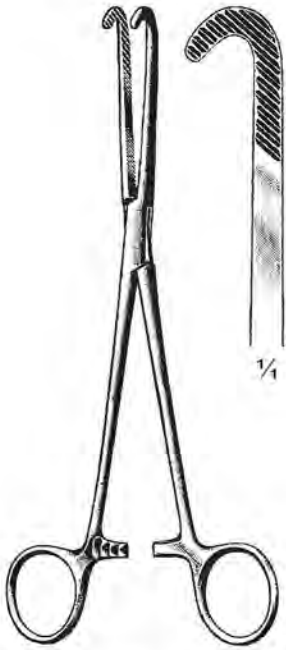

Bergstroem  
 857-01-21  
 21 cm / 8 1/4"

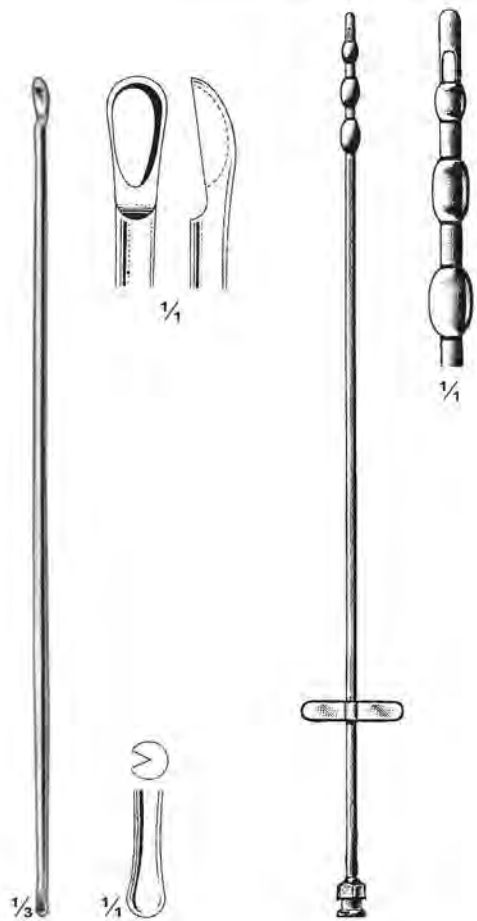

Moynihan  
 857-02-34  
 34 cm / 13 1/2"  
 Malleable

Mixer  
 857-03-30  
 30 cm / 12"

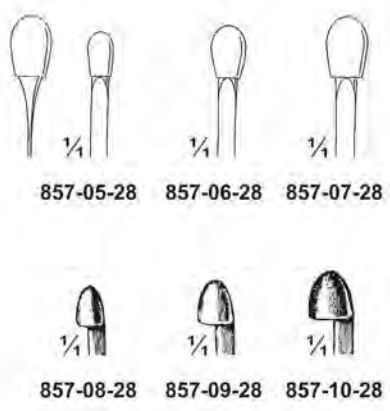

857-05-28    857-06-28    857-07-28  
 857-08-28    857-09-28    857-10-28



Hajek  
 857-04-16  
 16.5 cm / 6 1/2"

Desjardins  
 857-05-28 To 857-10-28  
 28 cm / 11"  
 Elastic



Mayo  
 857-11-33  
 33 cm / 13"  
 Malleable

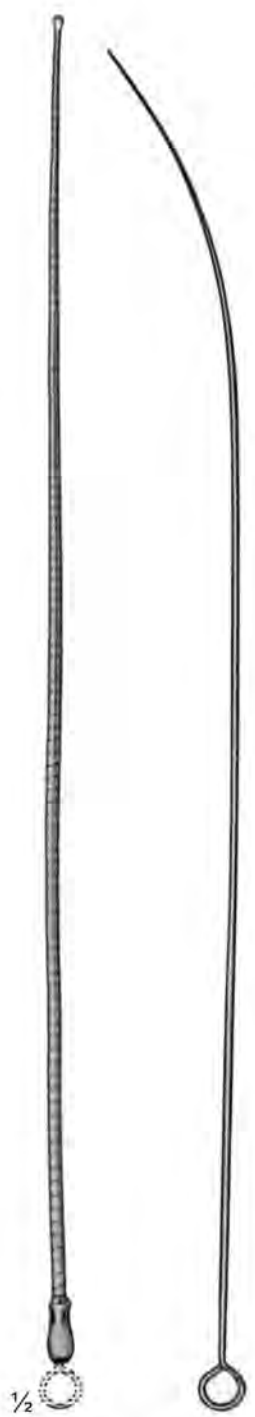

Ochsner  
 857-12-40  
 40cm / 16"  
 Flexible

Gallensteinzangen  
Gall Stone Forceps  
Pincettes pour calculs biliaires

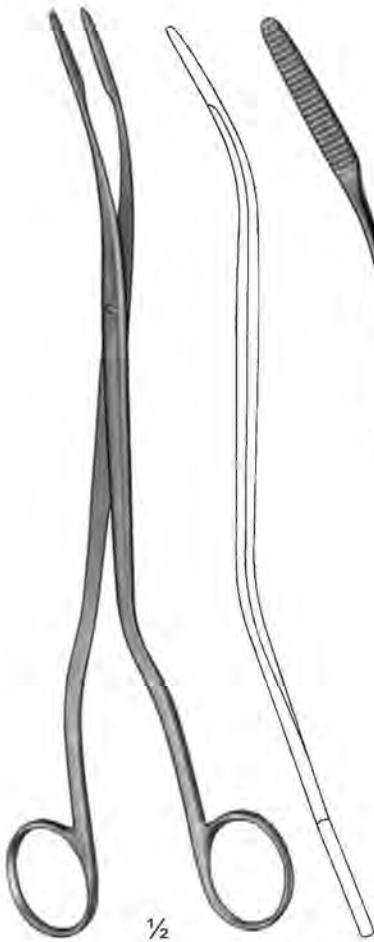

Czerny  
858-01-24  
24.5 cm / 9 3/4"

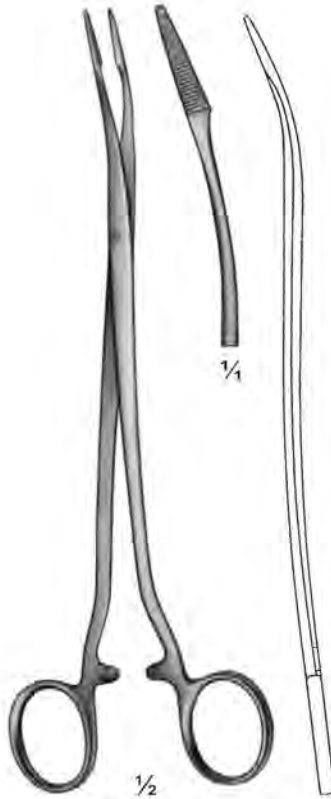

858-02-21  
21 cm / 8 1/4"



Mixer  
858-03-22  
22 cm / 8 3/4"



858-04-23



858-05-23



858-06-23



858-07-23



Desjardins  
858-04-23 To 858-07-23  
23 cm / 9"

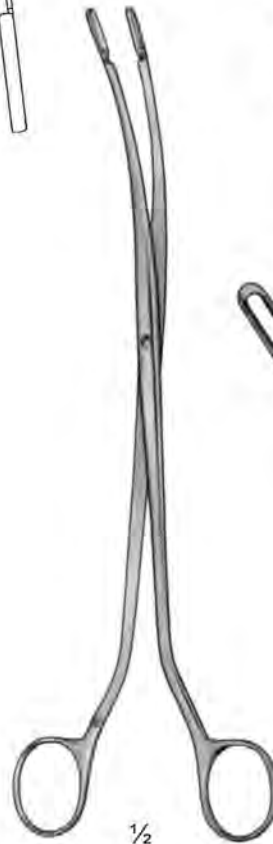

Desjardins  
858-08-24 To 858-09-23  
Extremely delicate



858-08-24  
24 cm / 9 1/2"

858-09-23  
23 cm / 9"

Gallensteinzangen  
Gall Stone Forceps  
Pincès pour calculs biliaires

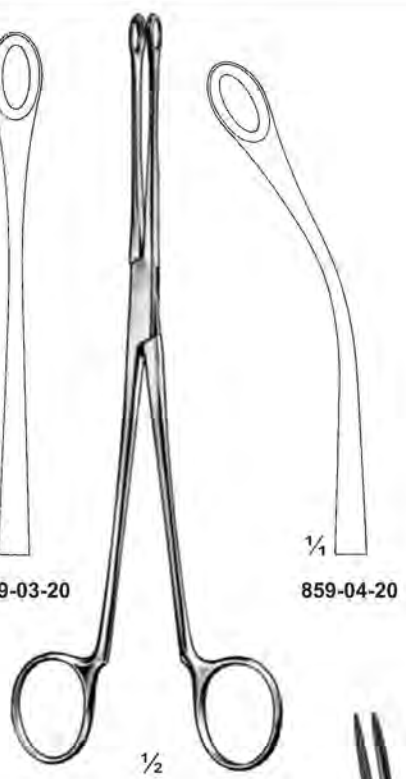
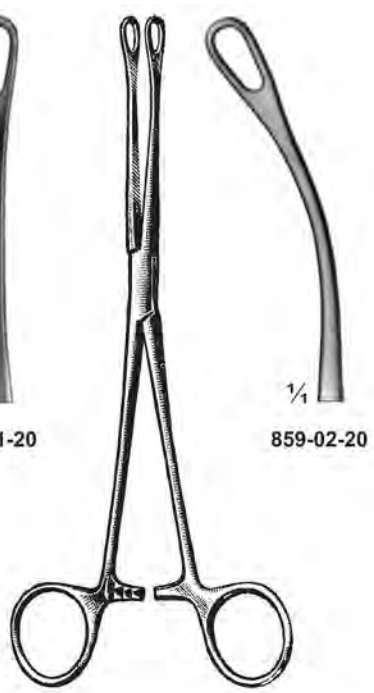

Blake  
859-01-20 & 859-02-20  
20 cm / 8"

Blake  
859-03-20 & 859-04-20  
20 cm / 8"

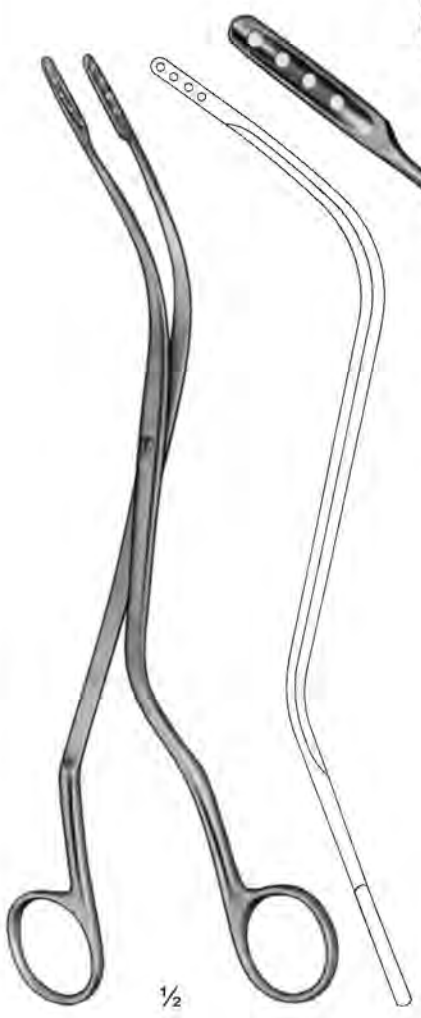

Tubinger Modell  
859-05-25  
25 cm / 10"

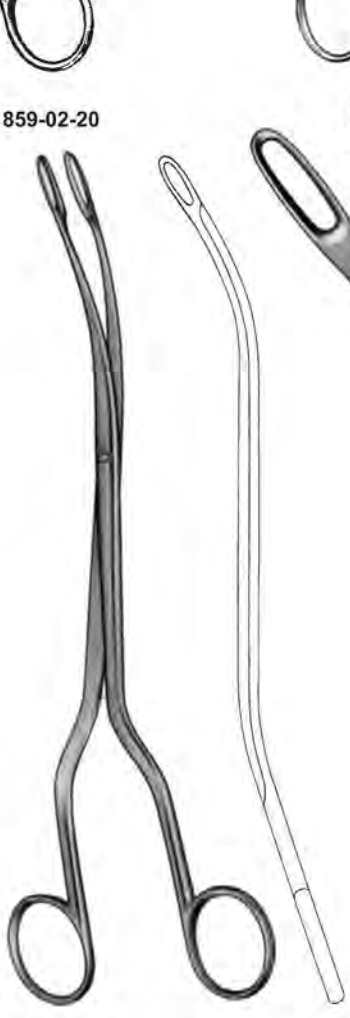

Stille  
859-06-24  
24.5 cm / 9¾"



Pelkmann  
859-07-26  
26 cm / 10¼"

Gallensteinzangen  
Gall Stone Forceps  
Pincès pour calculs biliaires

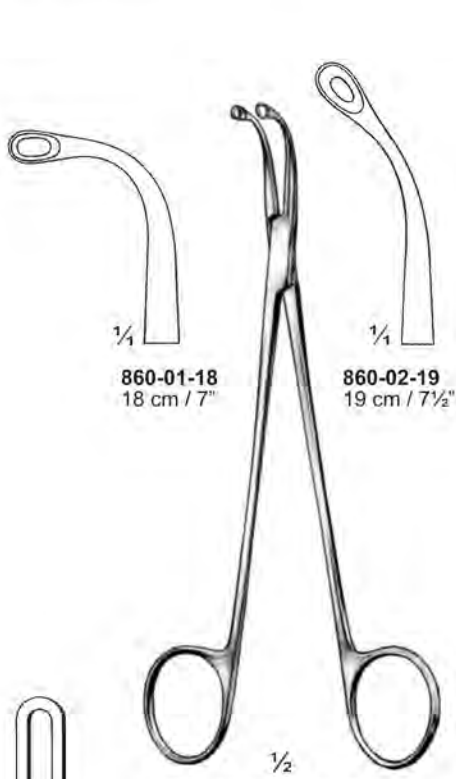

860-01-18  
18 cm / 7"

860-02-19  
19 cm / 7½"

Turner-Warwick  
860-01-18 & 860-02-19



Mayo-Blake  
860-03-20  
20 cm / 8"



Mayo-Blake  
860-04-20  
20 cm / 8"

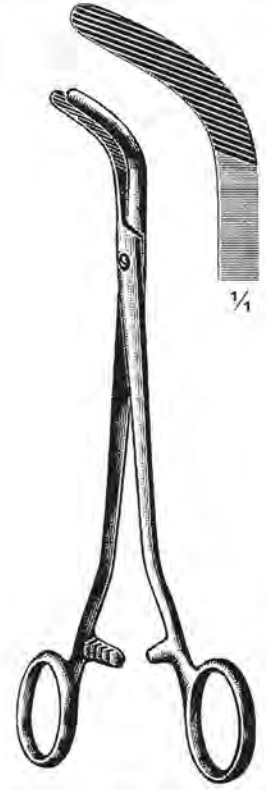

Crile  
860-05-21  
21 cm / 8¼"

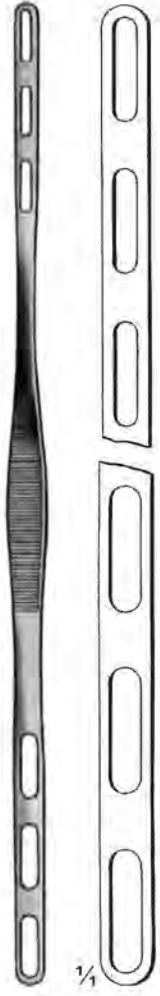

860-06-27  
27 cm / 10½"  
Malleable

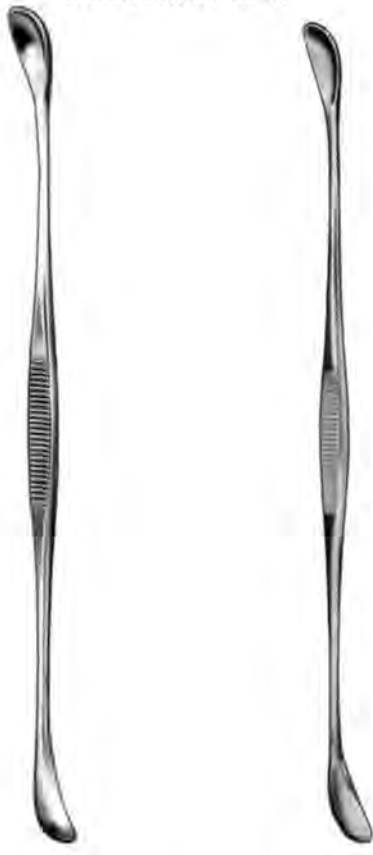

Mayo  
860-07-28  
28 cm / 11"

Fergusson  
860-08-21 To 860-10-23

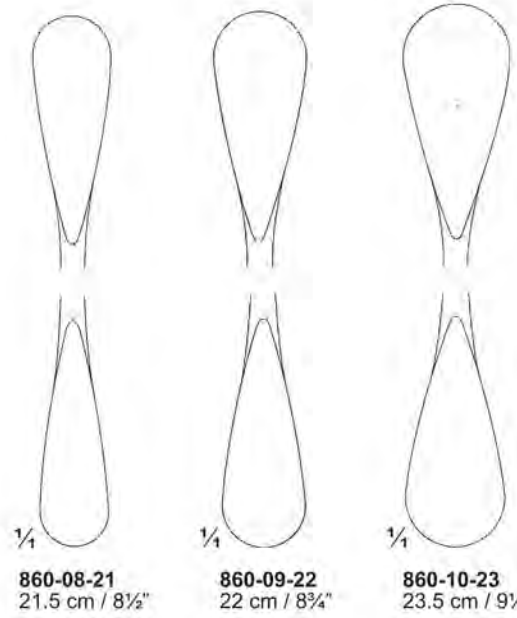

860-08-21  
21.5 cm / 8½"

860-09-22  
22 cm / 8¾"

860-10-23  
23.5 cm / 9¼"

**Ärgern Sie Steinschaufeln  
Gall Stone Scoops  
La Pierre de bile pellette**



Desjardins  
861-01-06 To 861-04-09  
30 cm / 12"  
Probe and catch  
with flexible shaft



861-01-06  
6 mm



861-02-07  
7 mm



861-03-08  
8 mm



861-04-09  
9 mm



861-05-27  
27 cm / 10½"  
Malleable



Luer-Koerte  
861-06-02 To 861-13-15  
32 cm / 12¾"  
Malleable



Fig. 000  
861-06-02  
861-14-02  
2.5 mm



Fig. 00  
861-07-03  
861-15-03  
3.2 mm



Fig. 0  
861-08-04  
861-16-04  
4.2 mm



Fig. 1  
861-09-05  
861-17-05  
5.5 mm



Fig. 2  
861-10-06  
861-18-06  
6.7 mm



Fig. 3  
861-11-08  
861-19-08  
8.0 mm



Fig. 4  
861-12-11  
861-20-11  
11 mm



Fig. 5  
861-13-15  
861-21-15  
15 mm



Luer-Koerte  
861-14-02 To 861-21-15  
27.5 cm / 10¾"  
Malleable



861-22-07  
7 mm



861-23-08  
8 mm



861-24-09  
9 mm

861-22-07 To 861-24-09  
30 cm / 12"  
Malleable

**Gallensteinlöffel  
Gall Stone Scoops  
Curettes pour calculs biliaires**

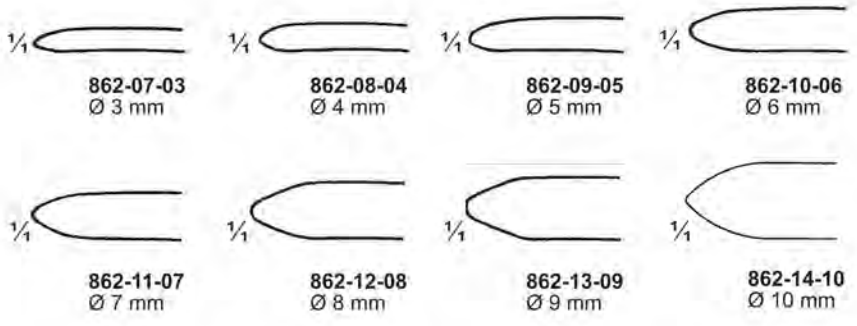

1/2  
**Moore**  
862-01-28  
28 cm / 11"



1/2  
**862-02-34**  
34 cm / 12 1/2"



**Mayo**  
862-03-04 To 862-05-07  
26 cm / 10 1/4"  
Malleable



1/4  
**862-03-04**  
4 mm



1/4  
**862-04-05**  
5 mm



1/4  
**862-05-07**  
7 mm



**Mayo**  
862-06-26  
26 cm / 10 1/4"  
Malleable



1/4  
5 mm



1/2      1/4  
**862-07-03 To 862-14-10**  
19 cm / 7 1/2"

# Gallensteinlöffel Gall Stone Scoops Curettes pour calculs biliaires

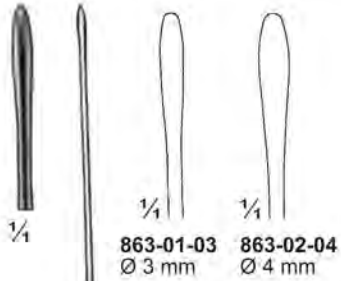

**Stucker**  
863-01-03 To 863-02-04  
33 cm / 13"  
Malleable

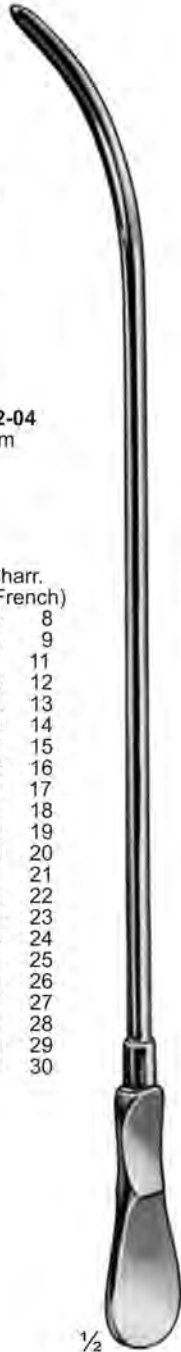

**Dittel**  
863-03-08 To 863-24-30  
34.5 cm / 13 1/4"  
Dilating sound

	Charr. (French)
863-03-08	8
863-04-09	9
863-05-11	11
863-06-12	12
863-07-13	13
863-08-14	14
863-09-15	15
863-10-16	16
863-11-17	17
863-12-18	18
863-13-19	19
863-14-20	20
863-15-21	21
863-16-22	22
863-17-23	23
863-18-24	24
863-19-25	25
863-20-26	26
863-21-27	27
863-22-28	28
863-23-29	29
863-24-30	30

**Bakes**  
863-25-01 To 863-37-13  
30 cm / 12"  
Malleable shaft

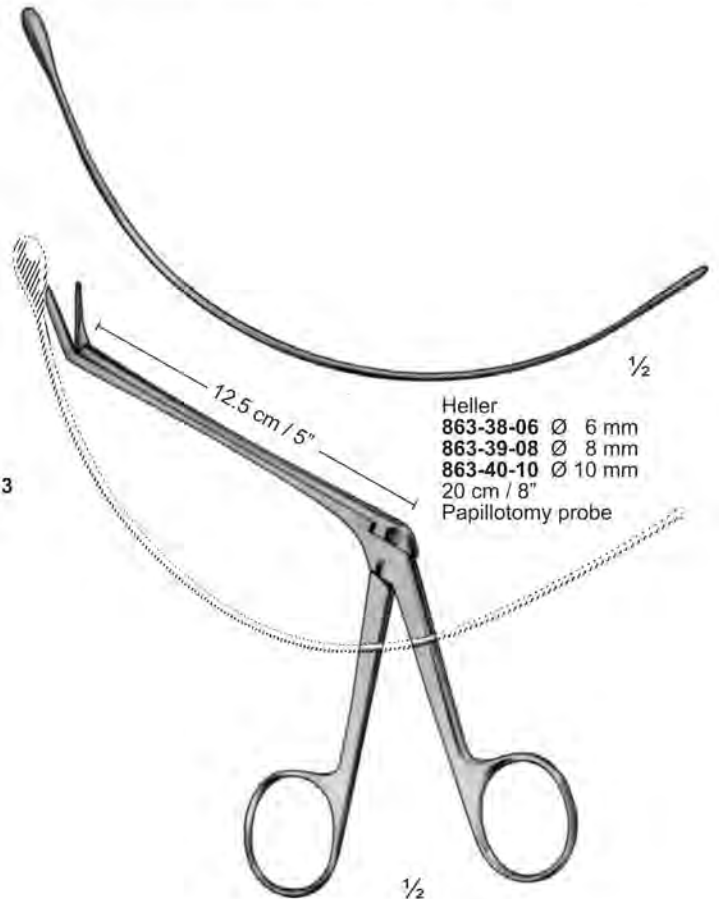
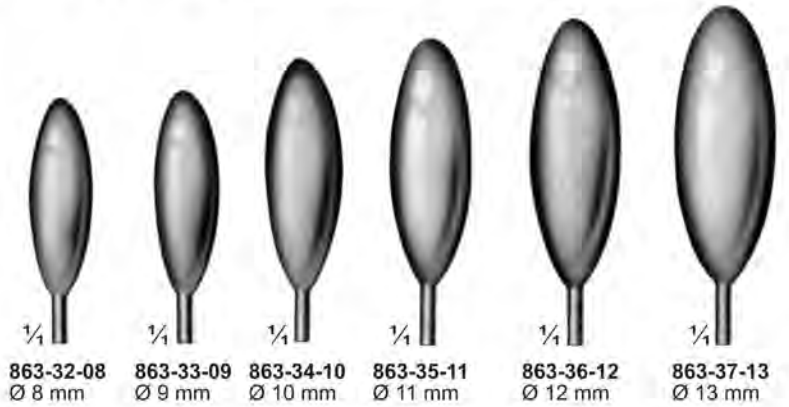
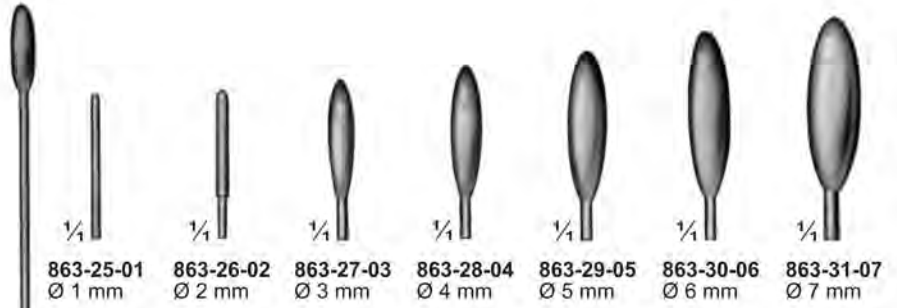

**Heller**  
863-41-12  
Shaft length 12.5 cm / 5"  
Biopsy forceps for papilla



Nierensteinzangen  
Kidney Stone Forceps  
Pincettes pour les calculs du bassinet

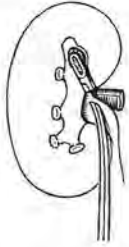

864-01-23  
23 cm / 9"



864-02-22  
22 cm / 8 3/4"



864-03-22  
22 cm / 8 3/4"



864-04-22  
22 cm / 8 3/4"



Randall  
864-01-23 To 864-06-19



864-05-19  
19 cm / 7 1/2"



864-06-19  
19 cm / 7 1/2"



Heiming  
864-07-17 & 864-08-16  
For children



864-07-17  
17 cm / 6 3/4"



864-08-16  
16 cm / 6 1/4"

**Nierensteinzangen**  
**Kidney Stone Forceps**  
**Pincettes pour les calculs du bassinet**

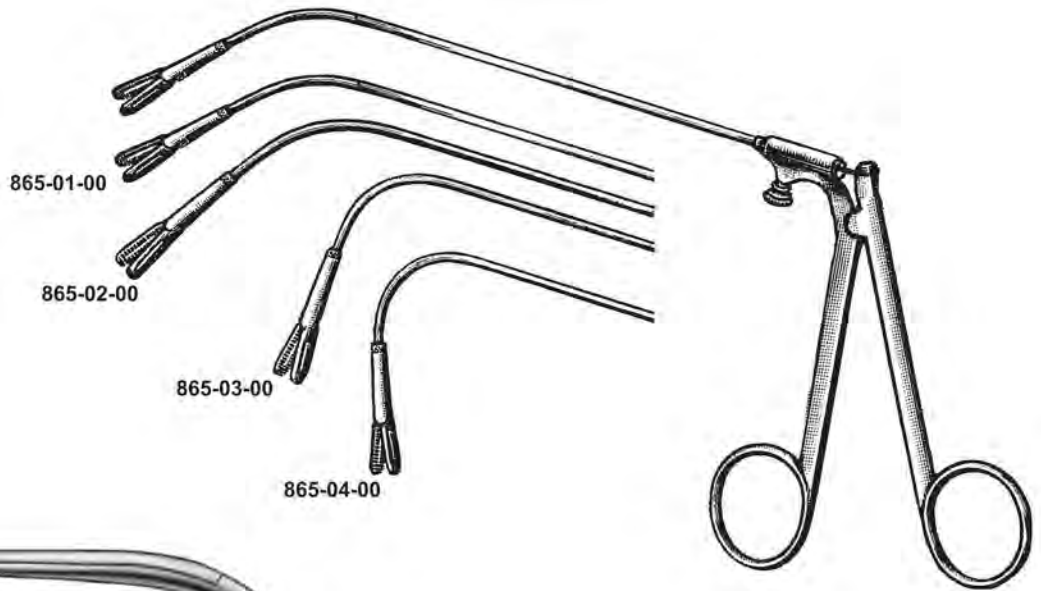

Ray  
865-01-00 To 865-04-00  
865-05-00  
Complete set of 865-01-00 To 865-04-00



Randall  
865-06-23 & 865-07-24

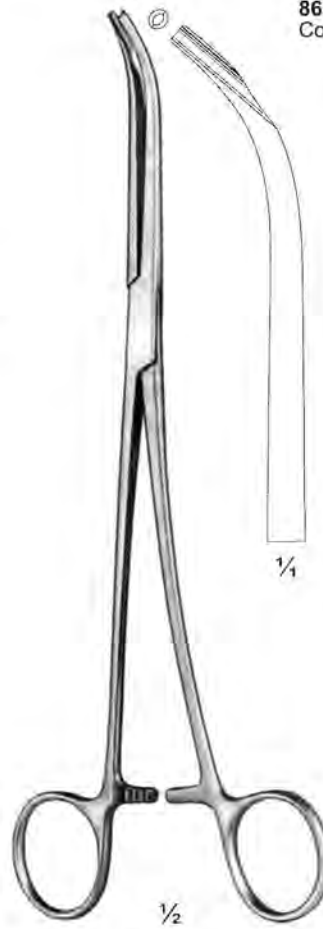

Sokeland  
865-08-24  
24 cm / 9 1/2"



Hirth  
865-09-18  
18 cm / 7"

Nierenfistelzangen  
Nephrostomy Forceps  
Pincès à néphrostomie

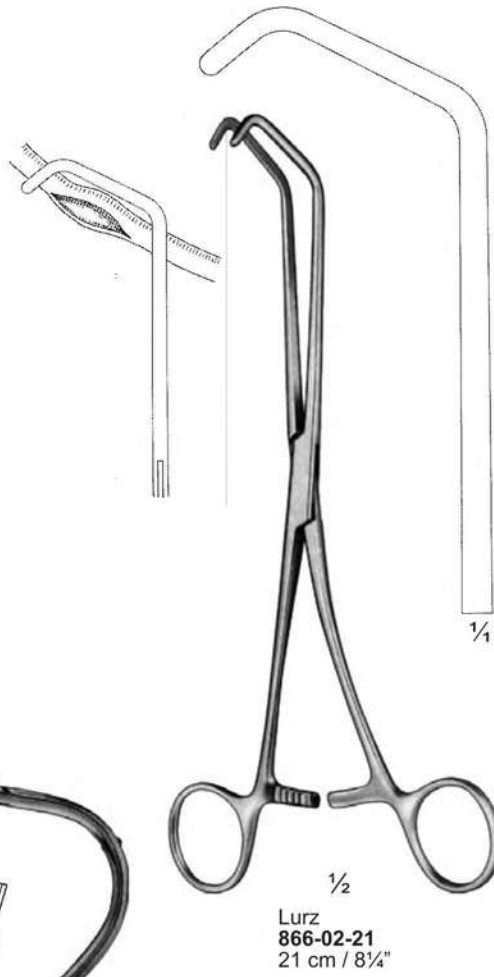
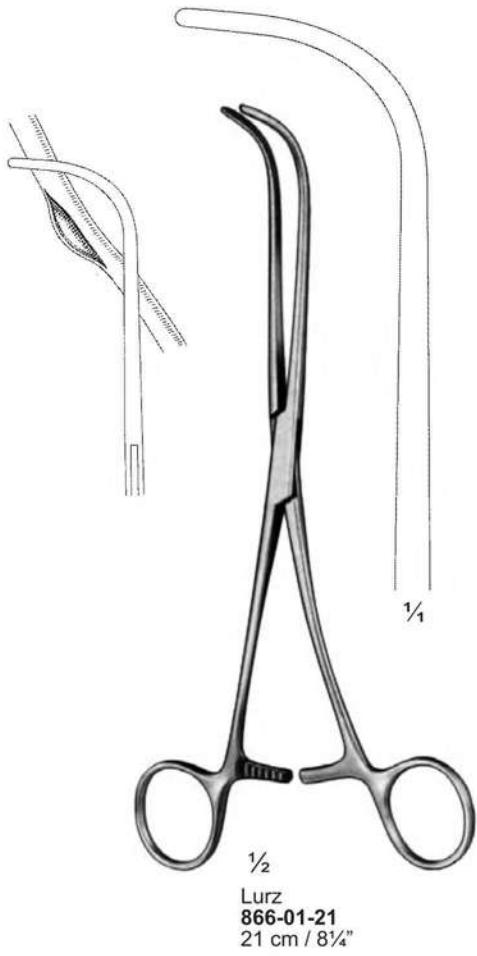

Uterusfazzange  
Uterine Seizing Forceps  
Pincés hystérolabes



$\frac{1}{2}$   
Collin  
867-01-28  
28.5 cm / 11 $\frac{1}{4}$ "



$\frac{1}{2}$   
Kocher  
867-02-26  
26.5 cm / 10 $\frac{1}{2}$ "



$\frac{1}{2}$   
Dartigues  
867-03-25  
25 cm / 10"

Niere Pedicle Zange  
 Kidney Pedicle Forceps  
 Les Forceps De Pedicle De Rein

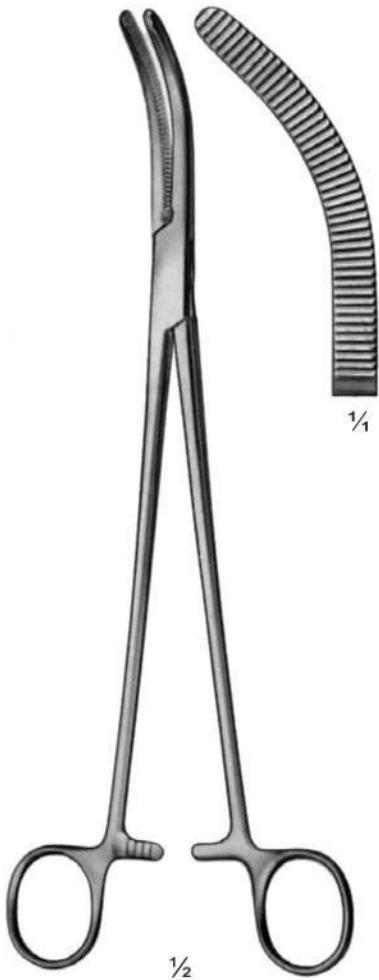

Wertheim  
 868-01-25  
 25 cm / 10"



Wertheim-Cullen  
 868-02-21  
 21.5 cm / 8 1/2"  
 Angle and pressure clamp

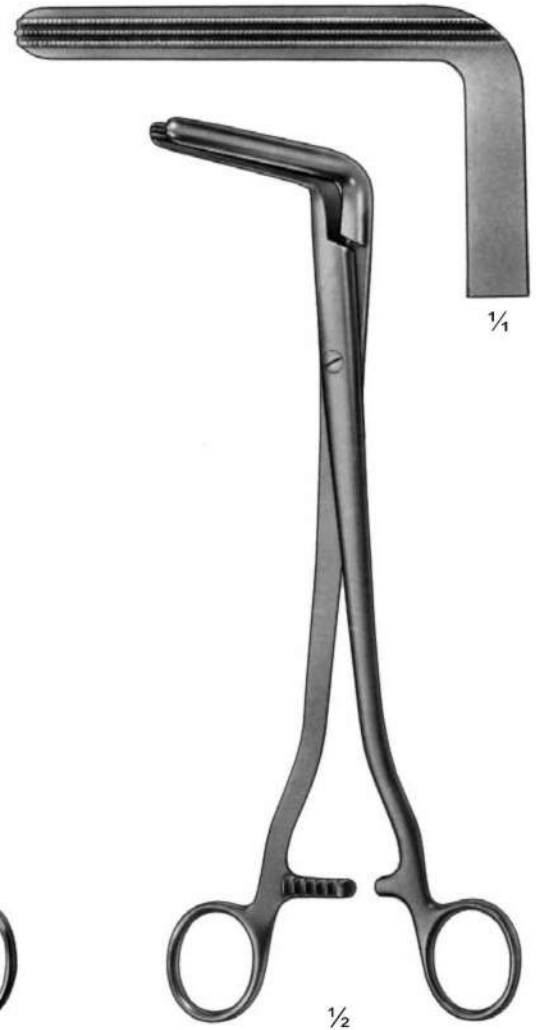

Wertheim  
 868-03-25  
 25 cm / 10"  
 Angle and pressure clamp  
 Atrauma toothed



**Hryntschak**  
**869-01-00**  
 Lateral balde 40 X 85 mm  
 Central balde 35 X 100 mm



1/4

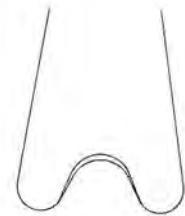

1/4

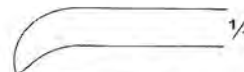

1/4



1/2

**Young**  
**869-02-21**  
 21 cm / 8 1/4"



1/4



1/2

**Young**  
**869-03-21**  
 21 cm / 8 1/4"

**Blasenwundsperrer, Prostatahaken**  
**Bladder Retractors, Prostatic Retractors**  
**Ecarteurs vésicaux, Ecarteurs prostatiques**

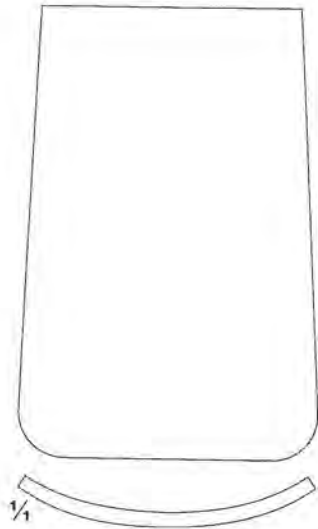

1/4

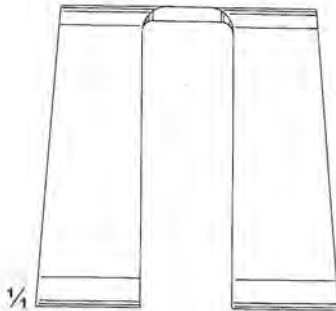

1/4



1/3

Millin-Bacon  
**870-04-24**  
 24 cm / 9 1/2"



1/2

Young  
**870-01-22**  
 22 cm / 8 3/4"



1/2

Young  
**870-02-22**  
 22 cm / 8 3/4"

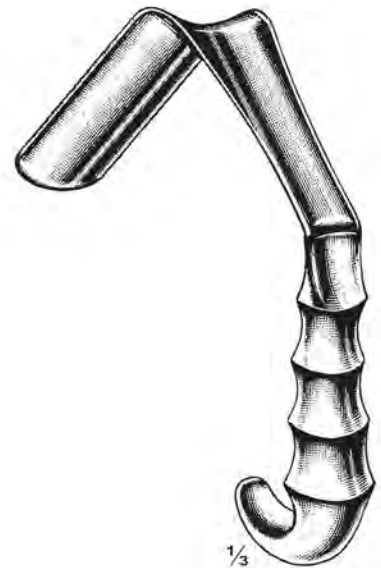

1/3

Proust  
**870-03-21**  
 21 cm / 8 1/4"  
 45 X 90 mm

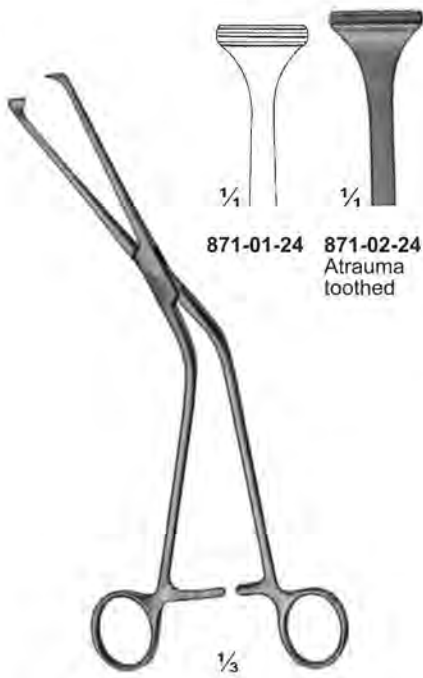

Millin  
**871-01-24 & 871-02-24**  
24.5 cm / 9 3/4"



Millin  
**871-03-23**  
23.5 cm / 9 1/4"  
Atrauma toothed

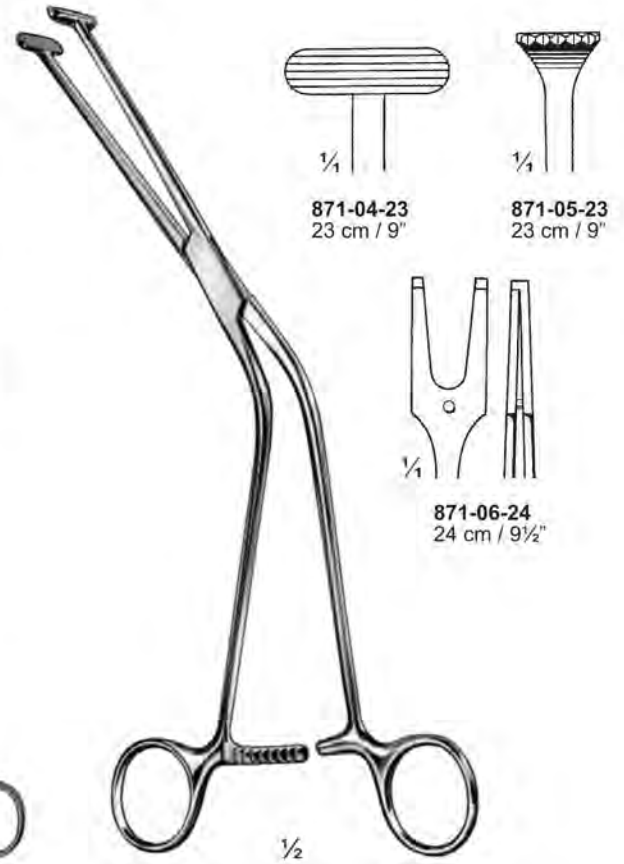

Millin  
**871-04-23 To 871-06-24**



Young  
**871-07-16**  
16.5 cm / 6 1/2"



**871-08-12**  
12.5 cm / 5"  
Ring diam. 4.8 mm  
Forceps for grasping the  
glans and the foreskin



**871-09-14**  
14.5 cm / 5 3/4"  
Fixation clamp for the  
spermatic cord

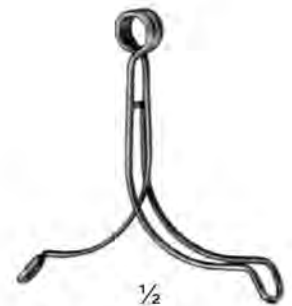

Stockmann  
**871-10-07**  
7 cm / 2 3/4"  
Penis clamp





1/2  
Strauss  
872-01-13  
13 cm / 5 1/8"  
Penis clamp



1/2  
872-02-16  
16 cm / 6 1/4"  
Hook for the  
spermatic cord



1/2  
Young  
872-03-20  
20 cm / 8"  
Prostatic lobe forceps

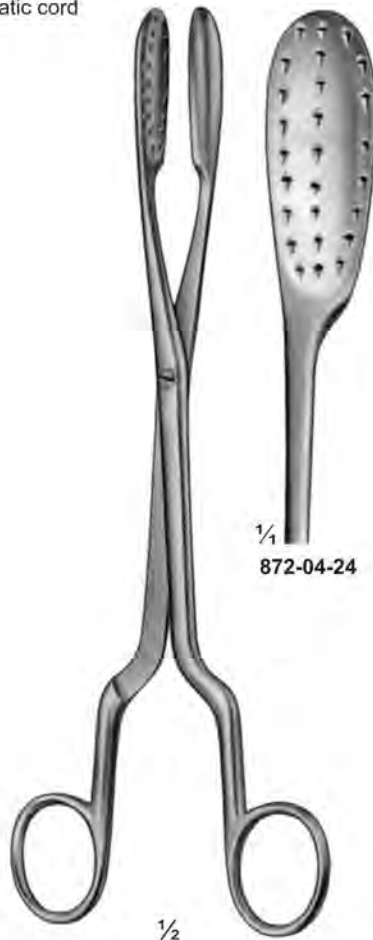

1/2  
Lewkowitz  
872-04-24 To 872-0-245  
24.5 cm / 9 3/4"  
Lithotomy forceps



1/4  
872-04-24

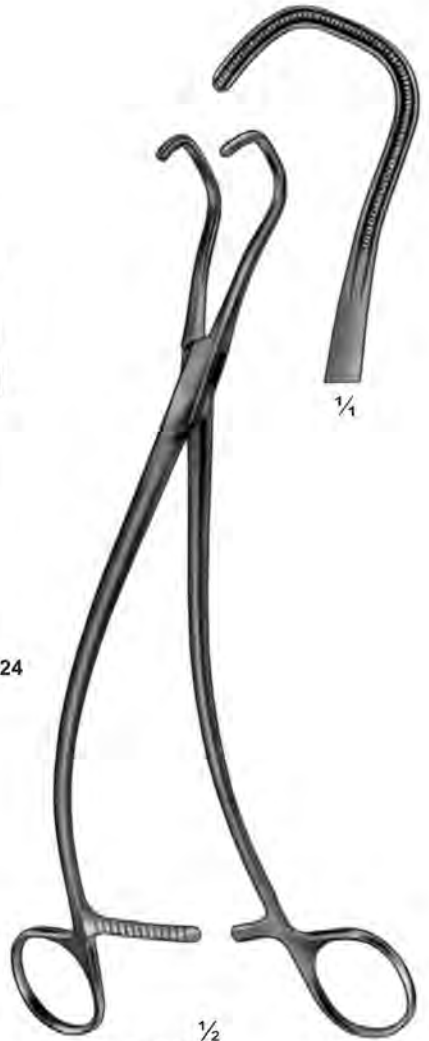

1/4  
872-05-24

1/4

1/2  
872-06-24  
24 cm / 9 1/2"  
Ureter forceps  
Atrauma toothed

<p><b>873-01-39</b> 39 cm / 15½"</p> <p>1/3</p>	<p><b>873-02-35</b> 35 cm / 13¾"</p> <p>1/3</p>	<p><b>873-03-49</b> 49 cm / 19½" Catheter guide</p> <p>1/3</p>	<p><b>873-04-46</b> 46 cm / 18" Catheter guide</p> <p>1/4</p>	<p><b>873-05-08 To 873-11-20</b> 29 cm / 11½" Male catheter</p> <p>1/2</p>	<p><b>873-12-06 To 873-24-20</b> 16 cm / 6¼" Female catheter</p> <p>1/4</p>	<p><b>873-25-06 To 873-42-27</b> 15 cm / 6"</p>
---	---	--	---	--	---	---

<p><b>873-05-08</b> 8 <b>873-06-10</b> 10 <b>873-07-12</b> 12 <b>873-08-14</b> 14 <b>873-09-16</b> 16 <b>873-10-18</b> 18 <b>873-11-20</b> 20</p>	<p><b>873-12-06</b> 6 <b>873-13-07</b> 7 <b>873-14-08</b> 8 <b>873-15-09</b> 9 <b>873-16-10</b> 10 <b>873-17-11</b> 11 <b>873-18-12</b> 12 <b>873-19-13</b> 13 <b>873-20-14</b> 14 <b>873-21-15</b> 15 <b>873-22-16</b> 16 <b>873-23-18</b> 18 <b>873-24-20</b> 20</p>	<p><b>873-25-06</b> 6 <b>873-26-07</b> 7 <b>873-27-08</b> 8 <b>873-28-09</b> 9 <b>873-29-10</b> 10 <b>873-30-11</b> 11 <b>873-31-12</b> 12 <b>873-32-13</b> 13 <b>873-33-14</b> 14 <b>873-34-15</b> 15 <b>873-35-16</b> 16 <b>873-36-17</b> 17 <b>873-37-18</b> 18 <b>873-38-20</b> 20 <b>873-39-21</b> 21 <b>873-40-23</b> 23 <b>873-41-24</b> 24 <b>873-42-27</b> 27</p>
---	--	--



Pitha  
**874-01-22**  
22 cm / 8<sup>3</sup>/<sub>4</sub>"  
Foreign body forceps

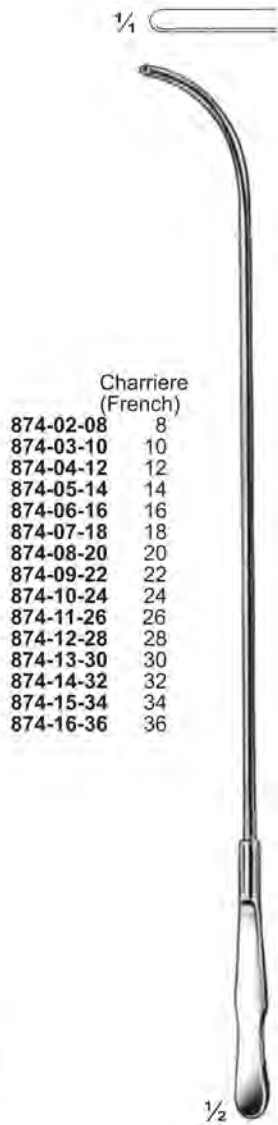

	Charriere (French)
<b>874-02-08</b>	8
<b>874-03-10</b>	10
<b>874-04-12</b>	12
<b>874-05-14</b>	14
<b>874-06-16</b>	16
<b>874-07-18</b>	18
<b>874-08-20</b>	20
<b>874-09-22</b>	22
<b>874-10-24</b>	24
<b>874-11-26</b>	26
<b>874-12-28</b>	28
<b>874-13-30</b>	30
<b>874-14-32</b>	32
<b>874-15-34</b>	34
<b>874-16-36</b>	36

Van Buren  
**874-02-08 To 874-16-36**  
28 cm / 11"  
**874-17-00**  
Complete set of  
874-02-08 To 874-16-36

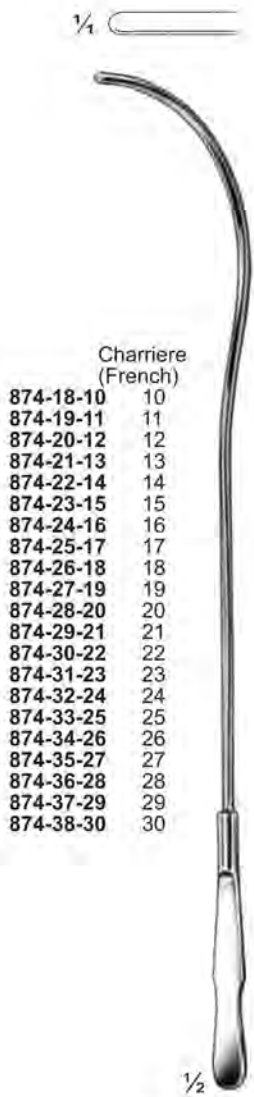

	Charriere (French)
<b>874-18-10</b>	10
<b>874-19-11</b>	11
<b>874-20-12</b>	12
<b>874-21-13</b>	13
<b>874-22-14</b>	14
<b>874-23-15</b>	15
<b>874-24-16</b>	16
<b>874-25-17</b>	17
<b>874-26-18</b>	18
<b>874-27-19</b>	19
<b>874-28-20</b>	20
<b>874-29-21</b>	21
<b>874-30-22</b>	22
<b>874-31-23</b>	23
<b>874-32-24</b>	24
<b>874-33-25</b>	25
<b>874-34-26</b>	26
<b>874-35-27</b>	27
<b>874-36-28</b>	28
<b>874-37-29</b>	29
<b>874-38-30</b>	30

Guyon  
**874-18-10 To 874-38-30**  
26 cm / 10<sup>1</sup>/<sub>4</sub>"  
**874-39-00**  
Complete set of  
874-18-10 To 874-38-30

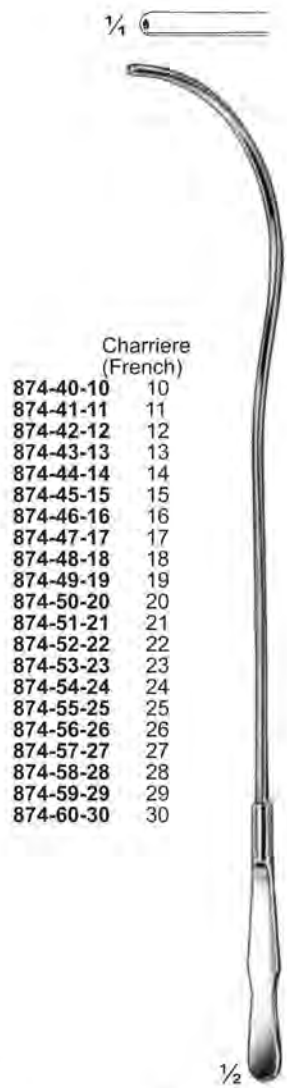

	Charriere (French)
<b>874-40-10</b>	10
<b>874-41-11</b>	11
<b>874-42-12</b>	12
<b>874-43-13</b>	13
<b>874-44-14</b>	14
<b>874-45-15</b>	15
<b>874-46-16</b>	16
<b>874-47-17</b>	17
<b>874-48-18</b>	18
<b>874-49-19</b>	19
<b>874-50-20</b>	20
<b>874-51-21</b>	21
<b>874-52-22</b>	22
<b>874-53-23</b>	23
<b>874-54-24</b>	24
<b>874-55-25</b>	25
<b>874-56-26</b>	26
<b>874-57-27</b>	27
<b>874-58-28</b>	28
<b>874-59-29</b>	29
<b>874-60-30</b>	30

Guyon  
**874-40-10 To 874-60-30**  
26 cm / 10<sup>1</sup>/<sub>4</sub>"  
**874-61-00**  
Complete set of  
874-40-10 To 874-60-30

Charriere  
(French)

875-01-06	6
875-02-07	7
875-03-08	8
875-04-09	9
875-05-10	10
875-06-11	11
875-07-12	12
875-08-13	13
875-09-14	14
875-10-15	15
875-11-16	16
875-12-17	17
875-13-18	18
875-14-19	19
875-15-20	20
875-16-21	21
875-17-22	22
875-18-23	23
875-19-24	24
875-20-25	25
875-21-26	26
875-22-27	27
875-23-28	28
875-24-29	29
875-25-30	30
875-26-31	31
875-27-32	32
875-28-33	33
875-29-34	34
875-30-35	35
875-31-36	36



1/2  
Dittel  
875-01-06 To 875-31-36  
22 cm / 8 3/4"  
875-32-00  
Complete set of  
875-01-06 To 875-31-36

Charriere  
(French)

875-33-06	6
875-34-07	7
875-35-08	8
875-36-09	9
875-37-10	10
875-38-11	11
875-39-12	12
875-40-13	13
875-41-14	14
875-42-15	15
875-43-16	16
875-44-17	17
875-45-18	18
875-46-19	19
875-47-20	20
875-48-21	21
875-49-22	22
875-50-23	23
875-51-24	24
875-52-25	25
875-53-26	26
875-54-27	27
875-55-28	28
875-56-29	29
875-57-30	30
875-58-31	31
875-59-32	32
875-60-33	33
875-61-34	34
875-62-35	35
875-63-36	36

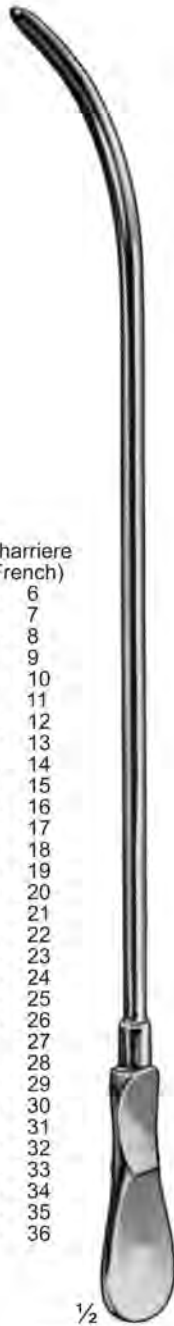

1/2  
Dittel  
875-33-06 To 875-63-36  
34.5 cm / 13 3/4"  
875-64-00  
Complete set of  
875-33-06 To 875-63-36

Charriere  
(French)

875-65-06	6
875-66-07	7
875-67-08	8
875-68-09	9
875-69-10	10
875-70-11	11
875-71-12	12
875-72-13	13
875-73-14	14
875-74-15	15
875-75-16	16
875-76-17	17
875-77-18	18
875-78-19	19
875-79-20	20



Dittel  
875-65-06 To 875-79-20  
35 cm / 14"  
875-80-00  
Complete set of  
875-65-06 To 875-79-20

Charriere  
(French)

875-81-06	6
875-82-07	7
875-83-08	8
875-84-09	9
875-85-10	10
875-86-11	11
875-87-12	12
875-88-13	13
875-89-14	14
875-90-15	15
875-91-16	16
875-92-17	17
875-93-18	18
875-94-19	19
875-95-20	20
875-96-21	21
875-97-22	22
875-98-23	23
875-99-24	24



Dittel  
875-81-06 To 875-99-24  
15 cm / 6"  
875-100-00  
Complete set of  
875-81-06 To 875-99-24

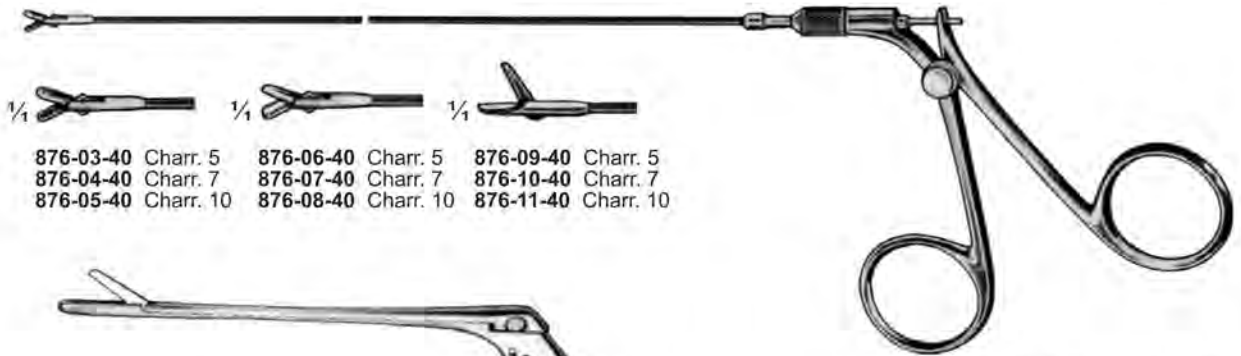

- |                     |                     |                     |
|---------------------|---------------------|---------------------|
| $\frac{1}{4}$       | $\frac{1}{4}$       | $\frac{1}{4}$       |
| 876-03-40 Charr. 5  | 876-06-40 Charr. 5  | 876-09-40 Charr. 5  |
| 876-04-40 Charr. 7  | 876-07-40 Charr. 7  | 876-10-40 Charr. 7  |
| 876-05-40 Charr. 10 | 876-08-40 Charr. 10 | 876-11-40 Charr. 10 |

876-03-40 To 876-11-40  
Shaft length 40 cm / 16"

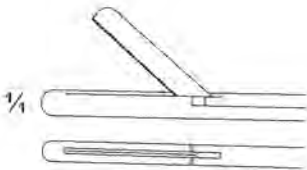
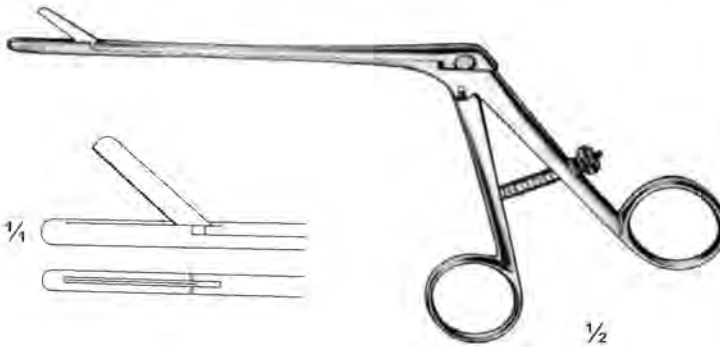

Sachse  
876-12-10  
Shaft length 10 cm / 4"

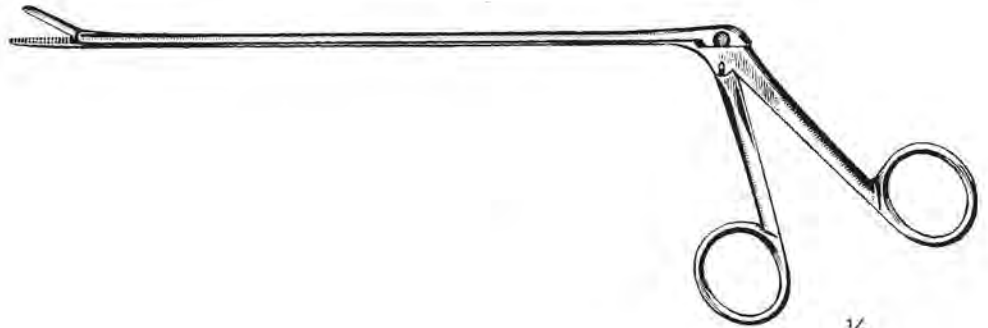

Sachse  
876-13-20 Shaft length 20 cm / 8"  
876-14-28 Shaft length 28 cm / 11"

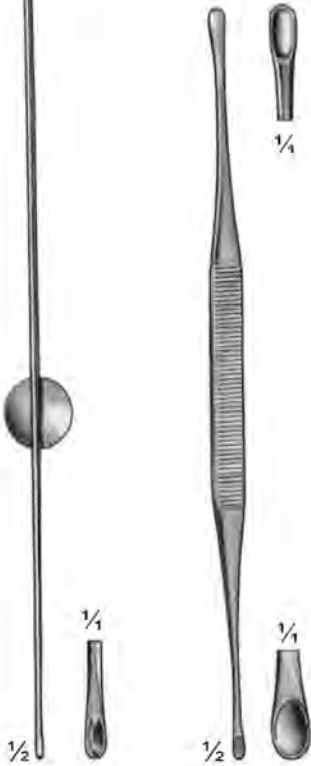

876-01-27  
27 cm / 10 1/2"  
Secretion curette

Asch  
876-02-20  
20 cm / 8"  
Secretion curette

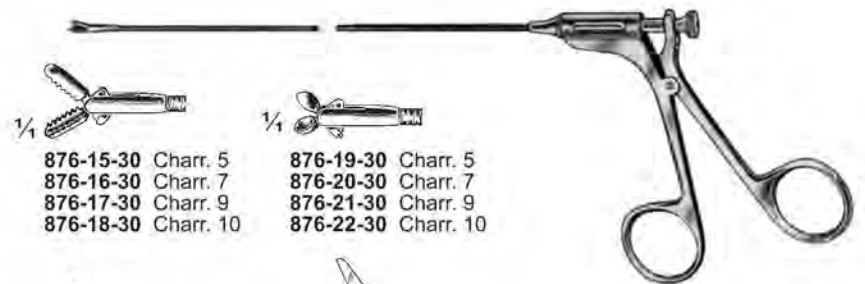

- |                     |                     |
|---------------------|---------------------|
| $\frac{1}{4}$       | $\frac{1}{4}$       |
| 876-15-30 Charr. 5  | 876-19-30 Charr. 5  |
| 876-16-30 Charr. 7  | 876-20-30 Charr. 7  |
| 876-17-30 Charr. 9  | 876-21-30 Charr. 9  |
| 876-18-30 Charr. 10 | 876-22-30 Charr. 10 |

876-15-30 To 876-28-30  
Shaft length 30 cm / 12"

- |                    |                     |
|--------------------|---------------------|
| $\frac{1}{4}$      | $\frac{1}{4}$       |
| 876-23-30 Charr. 5 | 876-25-30 Charr. 5  |
| 876-24-30 Charr. 7 | 876-26-30 Charr. 7  |
|                    | 876-27-30 Charr. 9  |
|                    | 876-28-30 Charr. 10 |



1/3

Guyon  
**877-01-21**  
Set of 21 urethral bougies and dilating sounds  
packed in metal case



1/2

**877-05-00**  
Knutson urethrography  
instrument



Winkelmann  
**877-02-12** Ø 12 mm  
**877-03-16** Ø 16 mm  
**877-04-20** Ø 20 mm  
Circumcision clamps



1/2

**877-06-08** Ø 8 mm  
**877-07-11** Ø 11 mm  
**877-08-13** Ø 13 mm  
**877-09-16** Ø 16 mm  
**877-10-21** Ø 21 mm  
**877-11-26** Ø 26 mm  
**877-12-32** Ø 32 mm  
Circumcision instruments

**Hakenzangen**  
**Uterine Tenaculum Forceps**  
**Pince pour le col delutéus**

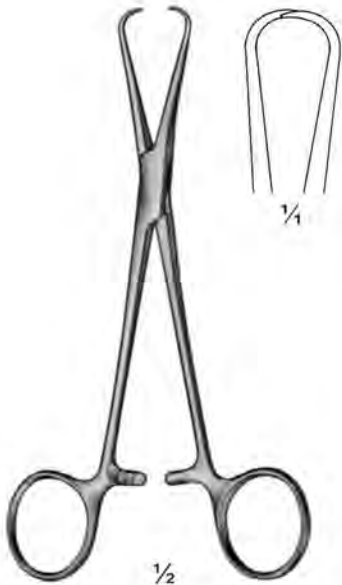

$\frac{1}{2}$   
**Bernhard**  
**878-01-16**  
 16 cm / 6 $\frac{1}{4}$ "

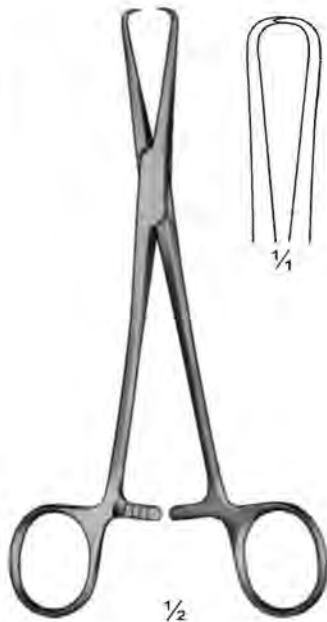

$\frac{1}{2}$   
**Pozzi**  
**878-02-18**  
 18 cm / 7"



$\frac{1}{2}$   
**Stade-Moore**  
**878-03-17**  
 17 cm / 6 $\frac{3}{4}$ "  
 Strong pattern



$\frac{1}{2}$   
**Barrett**  
**878-04-18**  
 18 cm / 7"



$\frac{1}{2}$   
**Adair**  
**878-05-19**  
 19 cm / 7 $\frac{1}{2}$ "



**Braun**  
**878-06-25**  
 25 cm / 10"



**Jarcho**  
**878-07-20**  
 20 cm / 8"

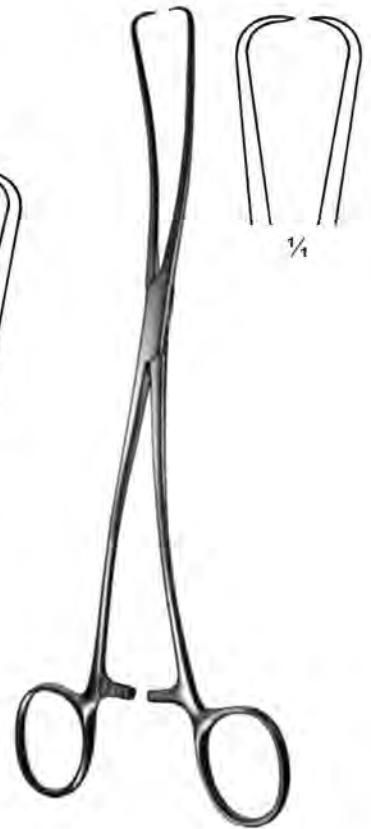

**Duplay**  
**878-08 -25** 25 cm / 10"  
**878-09-28** 28 cm / 11"

**Hakenzangen**  
**Uterine Tenaculum Forceps**  
**Pince pour le col delutérus**



$\frac{1}{2}$   
**Braun**  
**879-01-16**  
 16 cm / 6 $\frac{1}{4}$ "



$\frac{1}{2}$   
**Lahey**  
**879-02-15 & 879-03-15**  
 15 cm / 6"



$\frac{1}{2}$   
**Czerny**  
**879-04-21**  
 21 cm / 8 $\frac{1}{4}$ "

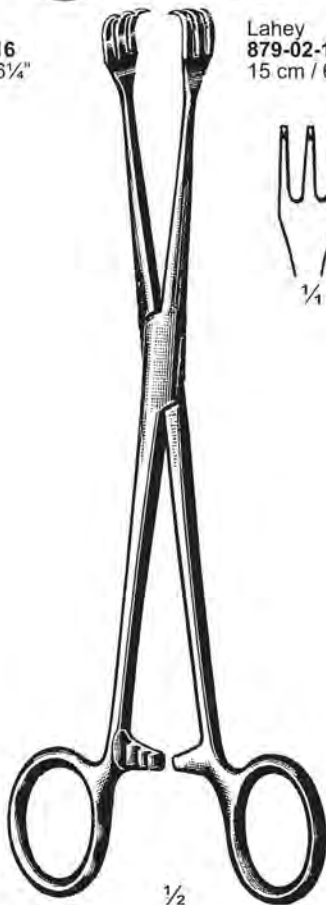

$\frac{1}{2}$   
**Gordon**  
**879-05-24**  
 24 cm / 9 $\frac{1}{2}$ "



**879-06-24**  
 24 cm / 9 $\frac{1}{2}$ "

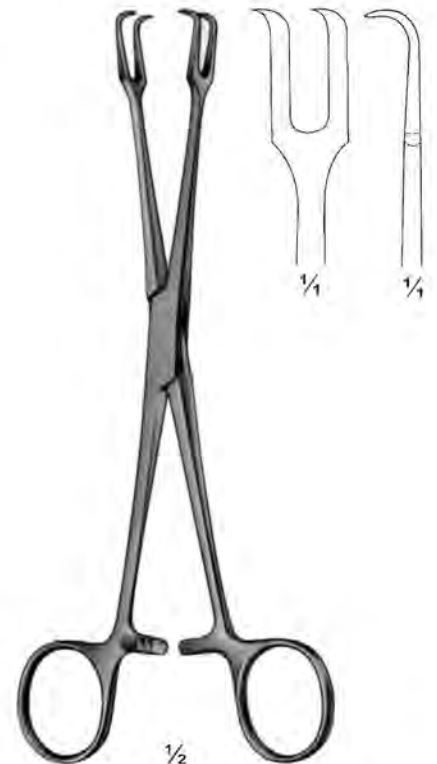

$\frac{1}{2}$   
**Museux**  
**879-07-20**  
 20 cm / 8"



**Hakenzangen**  
**Uterine Tenaculum Forceps**  
**Pince pour le col delutérus**



Schroeder  
880-01-25 To 880-03-25  
25 cm / 10"

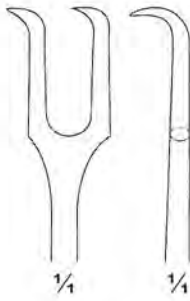

880-01-25



880-02-25



880-03-25  
Sideways cur

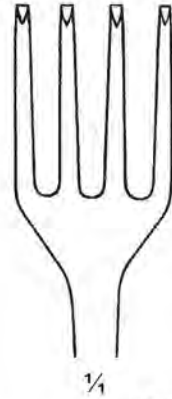

Schroeder  
880-04-27  
27 cm / 10 1/2"



Pratt  
880-05-26  
26 cm / 10 1/4"



Pratt  
880-06-27  
27 cm / 10 1/2"

**Hakenzangen**  
**Uterine Tenaculum Forceps**  
**Pince pour le col delutérus**

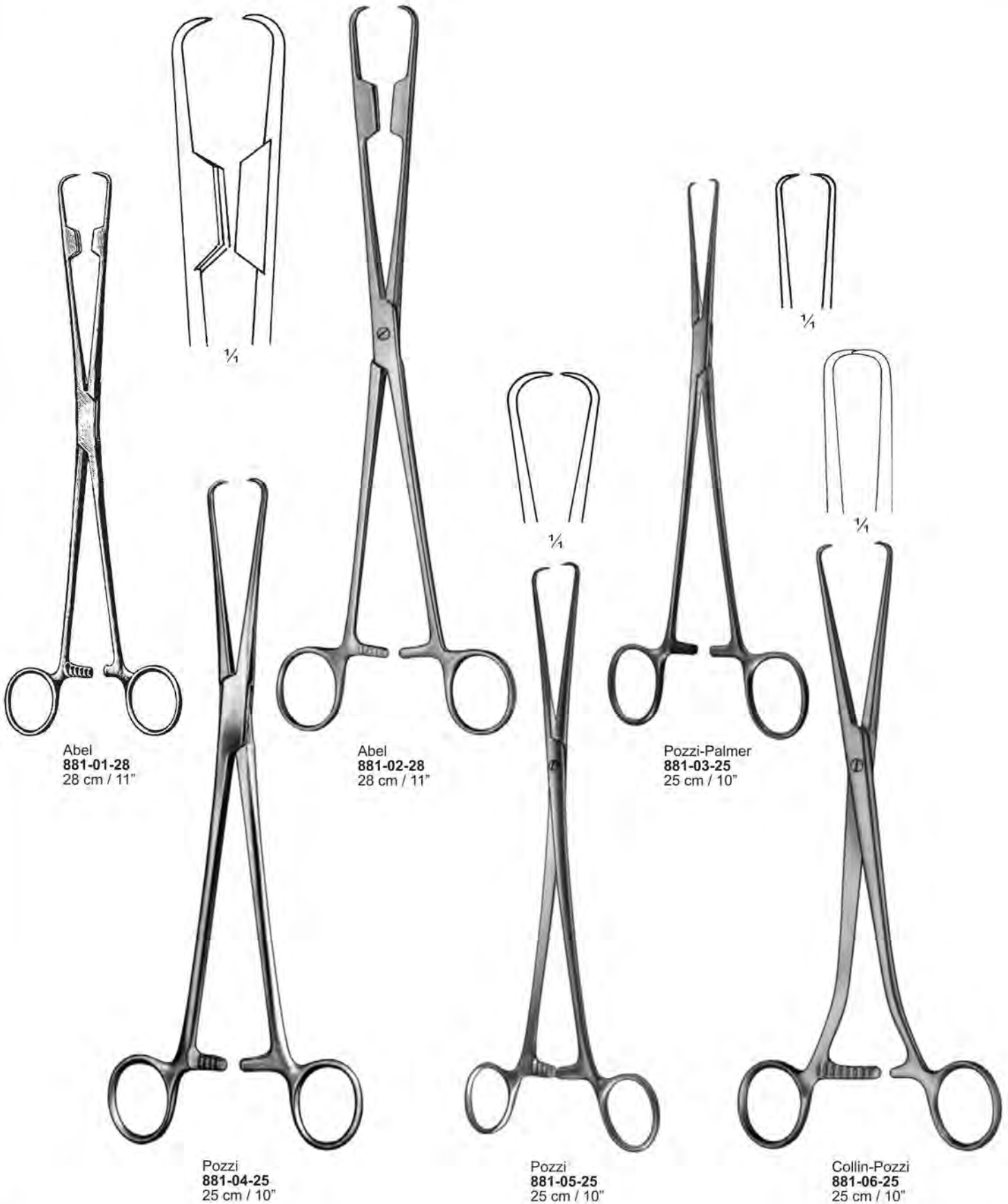

Hakenzangen  
 Uterine Tenaculum Forceps  
 Pince pour le col delutéris

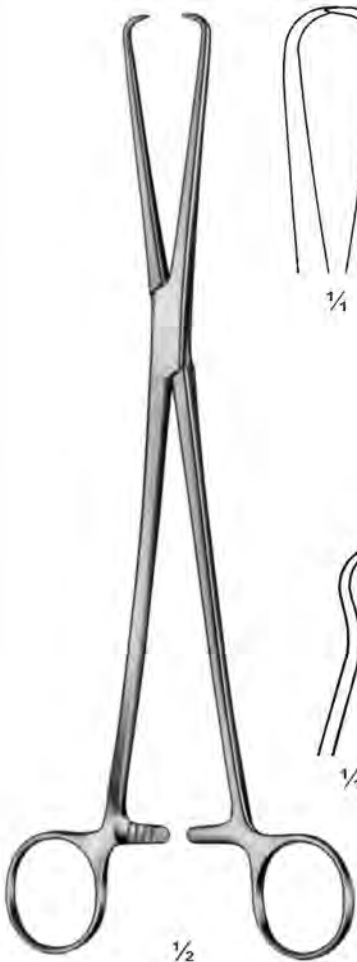

$\frac{1}{2}$   
 Schroeder  
 882-01-25  
 25 cm / 10"  
 Standard

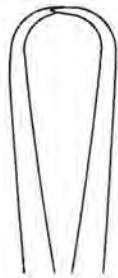

$\frac{1}{4}$



$\frac{1}{4}$



$\frac{1}{2}$   
 Schroeder  
 882-02-25  
 25 cm / 10"

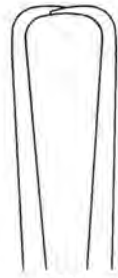

$\frac{1}{4}$

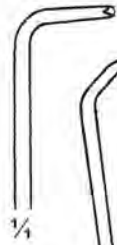

$\frac{1}{4}$

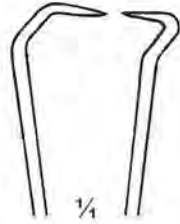

$\frac{1}{4}$

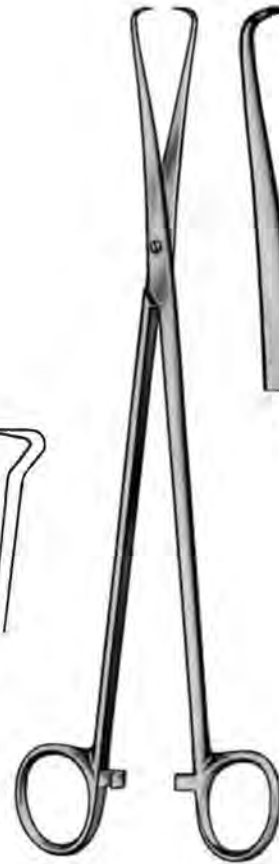

882-03-27  
 27 cm / 10½"



$\frac{1}{4}$



Skene  
 882-04-24  
 24 cm / 9½"



Kahn  
 882-05-24  
 24 cm / 9½"



Beacham  
 882-06-26  
 26 cm / 10¼"

**Hakenzangen**  
**Uterine Tenaculum Forceps**  
**Pince pour le col delutéus**

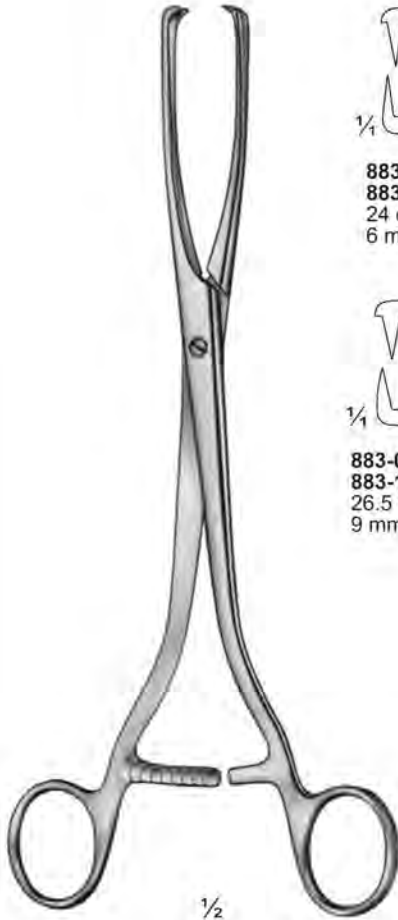

Museux  
 883-01-24 To 883-06-26



883-01-24  
 883-07-24  
 24 cm / 9½"  
 6 mm



883-02-24  
 883-08-24  
 24 cm / 9½"  
 8 mm



883-03-24  
 883-09-24  
 24 cm / 9½"  
 10 mm



883-04-26  
 883-10-26  
 26.5 cm / 10½"  
 9 mm



883-05-26  
 883-11-26  
 26.5 cm / 10½"  
 11 mm



883-06-26  
 883-12-26  
 26.5 cm / 10½"  
 13 mm



Museux  
 883-07-24 To 883-12-26

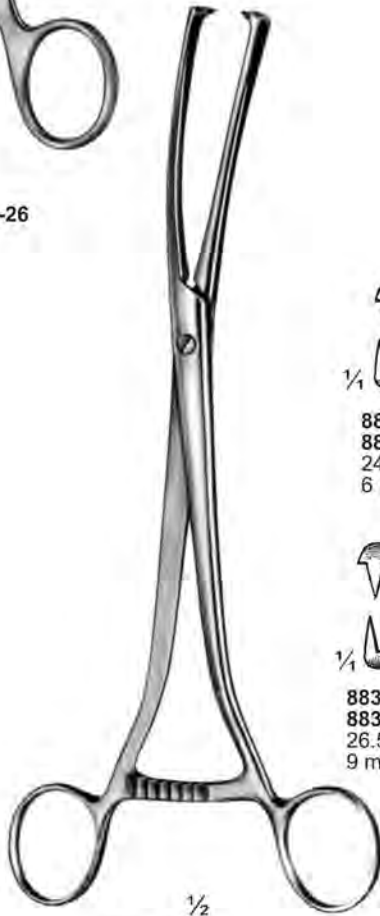

Museux  
 883-13-24 To 883-18-26



883-13-24  
 883-19-24  
 24 cm / 9½"  
 6 mm



883-14-24  
 883-20-24  
 24 cm / 9½"  
 8 mm



883-15-24  
 883-21-24  
 24 cm / 9½"  
 10 mm



883-16-26  
 883-22-26  
 26.5 cm / 10½"  
 9 mm



883-17-26  
 883-23-26  
 26.5 cm / 10½"  
 11 mm



883-18-26  
 883-24-26  
 26.5 cm / 10½"  
 13 mm

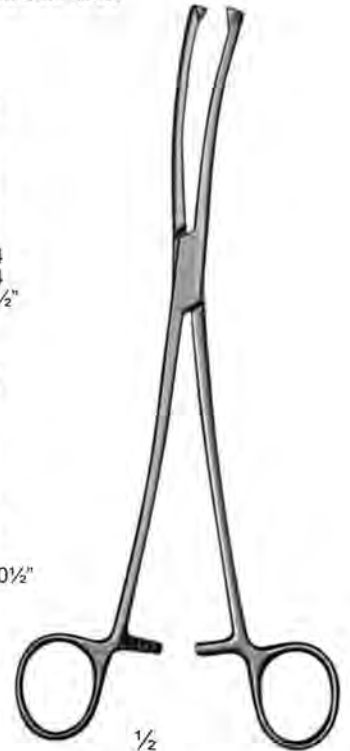

Museux  
 883-19-24 To 883-24-26

**Hakenzangen**  
**Uterine Tenaculum Forceps**  
**Pince pour le col delutéus**



$\frac{1}{2}$   
**Museux**  
**884-01-20**  
 20 cm / 8"



$\frac{1}{2}$   
**Museux-Palmer**  
**884-02-24**  
 24 cm / 9½"



$\frac{1}{2}$   
**Kustner**  
**884-04-25**  
 25 cm / 10"

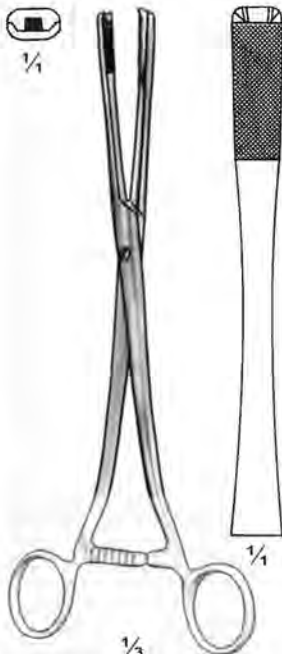

$\frac{1}{3}$   
**H. G. Muller**  
**884-03-24**  
 24 cm / 9½"  
 With Tungsten Carbide inserts

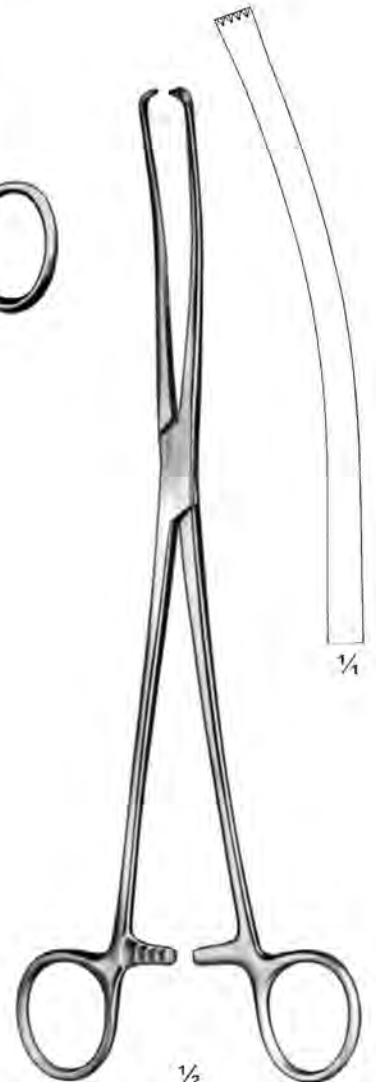

$\frac{1}{2}$   
**IOWA**  
**884-05-26**  
 26 cm / 10¼"

**Hakenzangen**  
**Uterine Tenaculum Forceps**  
**Pince pour le col delutéus**

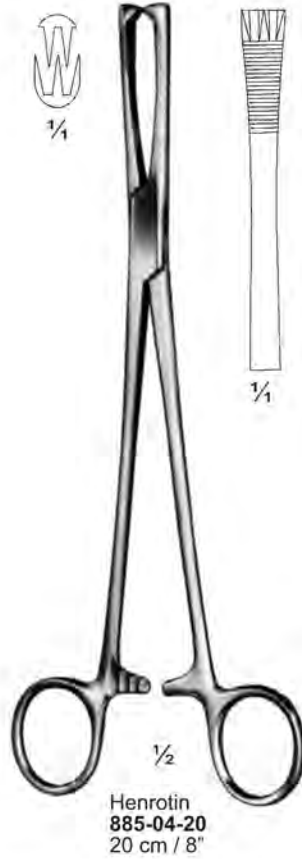
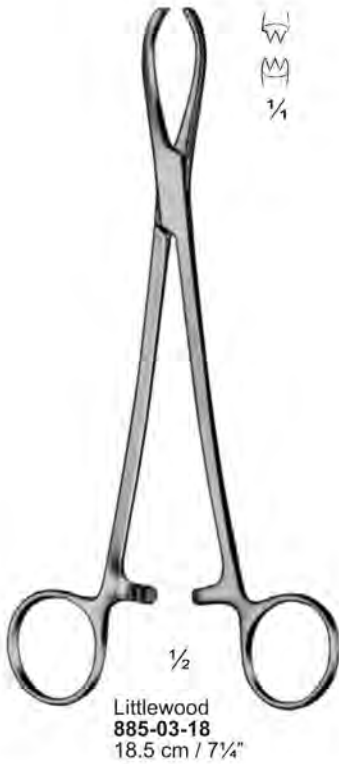
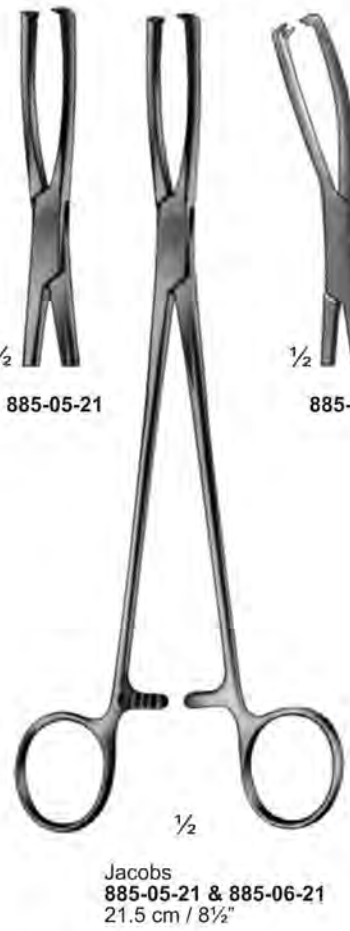

Hakenzangen  
 Uterine Tenaculum Forceps  
 Pince pour le col delutérus

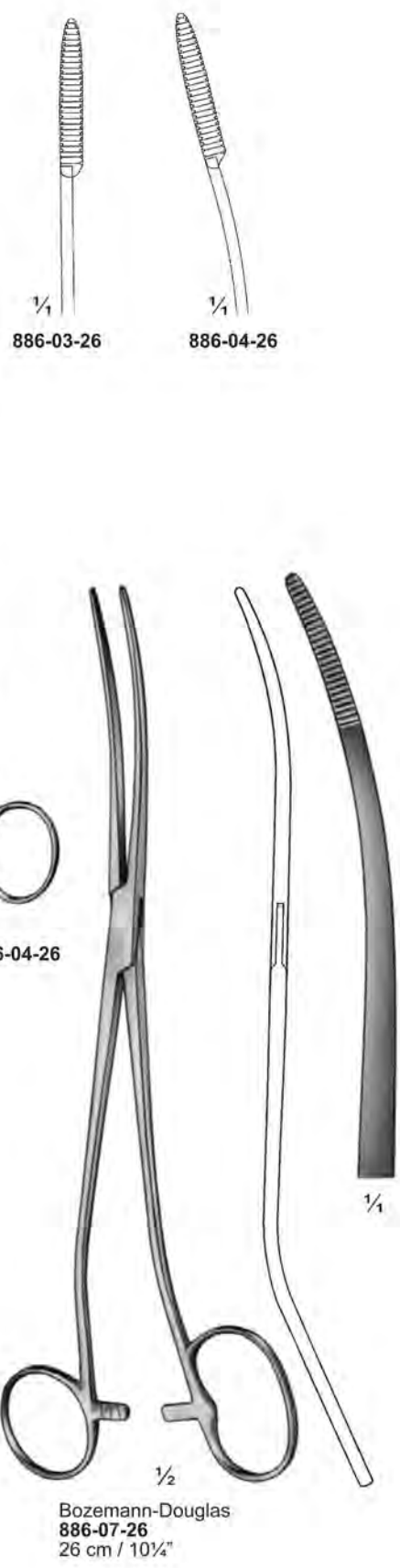
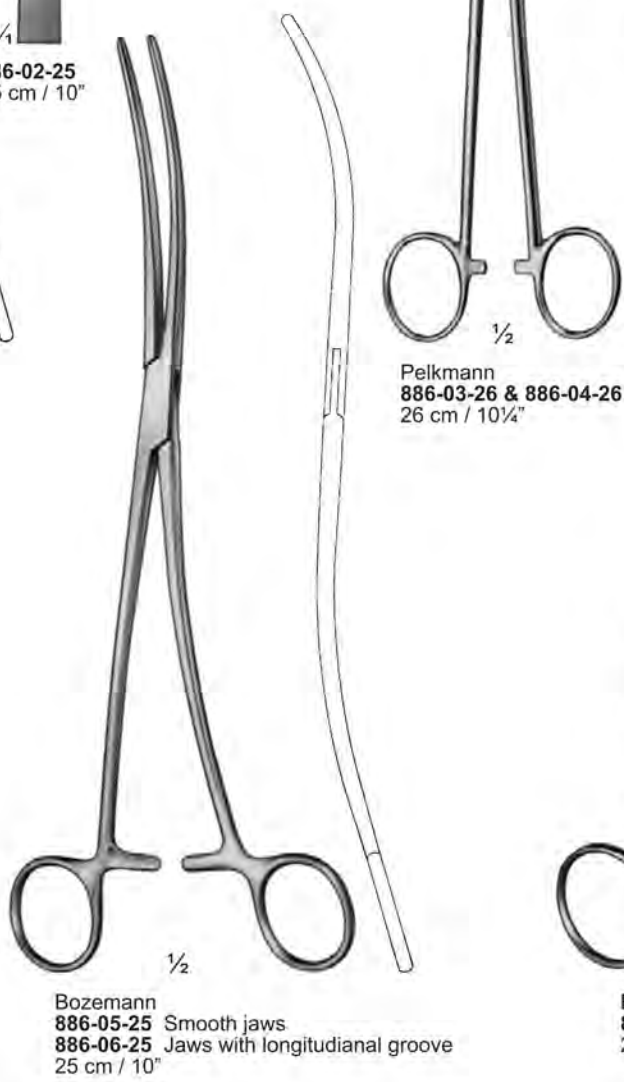
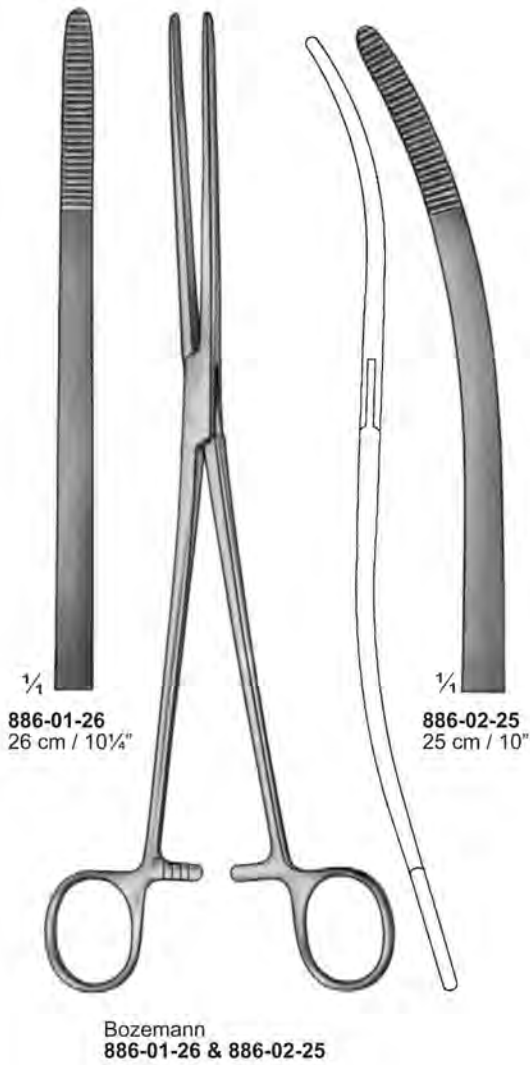

Hakenzangen  
 Uterine Tenaculum Forceps  
 Pince pour le col delutérus



Blumenthal  
 887-01-29  
 29 cm / 11 1/2"  
 Dressing forceps

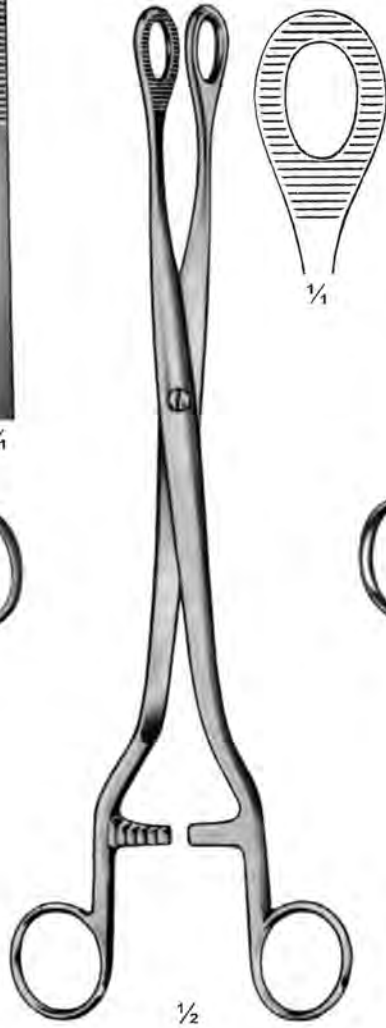

Noto  
 887-03-27  
 27 cm / 10 1/2"



Kelly  
 887-02-32  
 32 cm / 12 1/2"



Bumm  
 887-04-28  
 28 cm / 11"



**Uterus-Ploypenzangen  
Uterine Polypus Forceps  
Pincès à polypes utérins**



888-01-25 & 888-02-27



888-01-25  
25 cm / 10"



888-02-27  
27 cm / 10½"

ATRAUMA TOOTHED



Heywood-Smith  
888-03-20  
20 cm / 8"

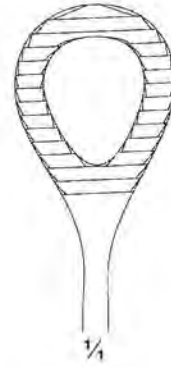

¼



Doyen  
888-04-20  
20 cm / 8"

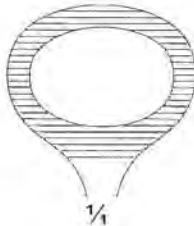

¼

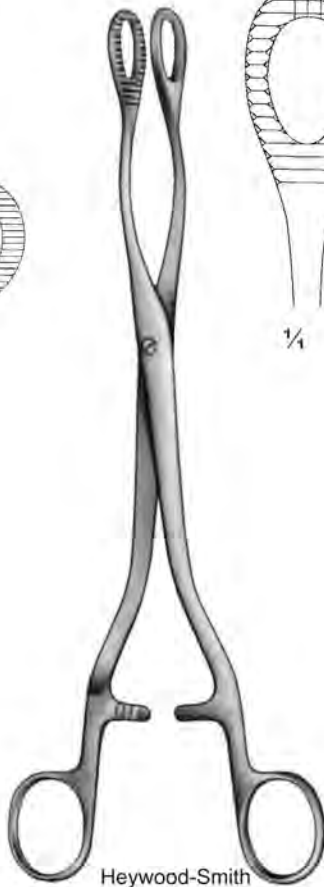

Heywood-Smith  
888-05-25  
25 cm / 10"

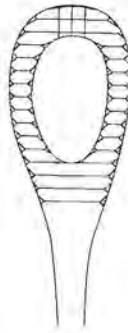

¼

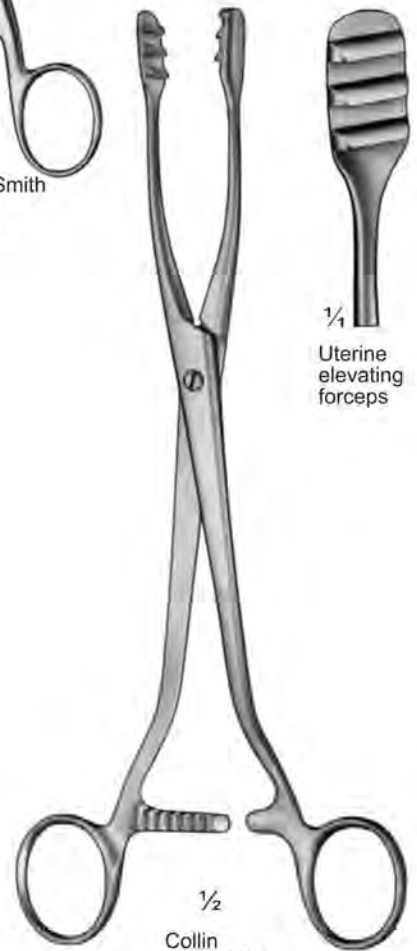

Collin  
888-06-25  
25 cm / 10"



¼  
Uterine elevating forceps

**Uterusfazzange  
Uterine Seizing Forceps  
Pincés hystérolabes**



$\frac{1}{2}$   
Strassmann  
889-01-27  
27 cm / 10½"



$\frac{1}{2}$   
Somers  
889-02-23  
23 cm / 9"



$\frac{1}{2}$   
Somers  
889-03-28  
28.5 cm / 11¼"

**Uterusfasszange  
Uterine Seizing Forceps  
Pincés hystérolabes**

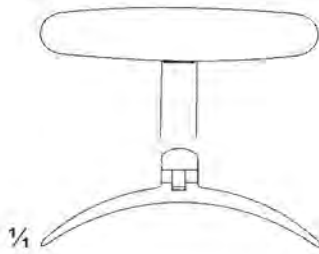
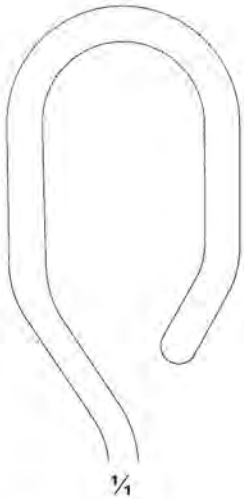

Dartigues  
890-01-27  
27 cm / 10½"



Collin  
890-02-25  
25 cm / 10"  
With moveable jaws



Collin  
890-03-25  
25 cm / 10"  
With moveable jaws

**Uterusfasazange  
Uterine Seizing Forceps  
Pincès hystérolabes**

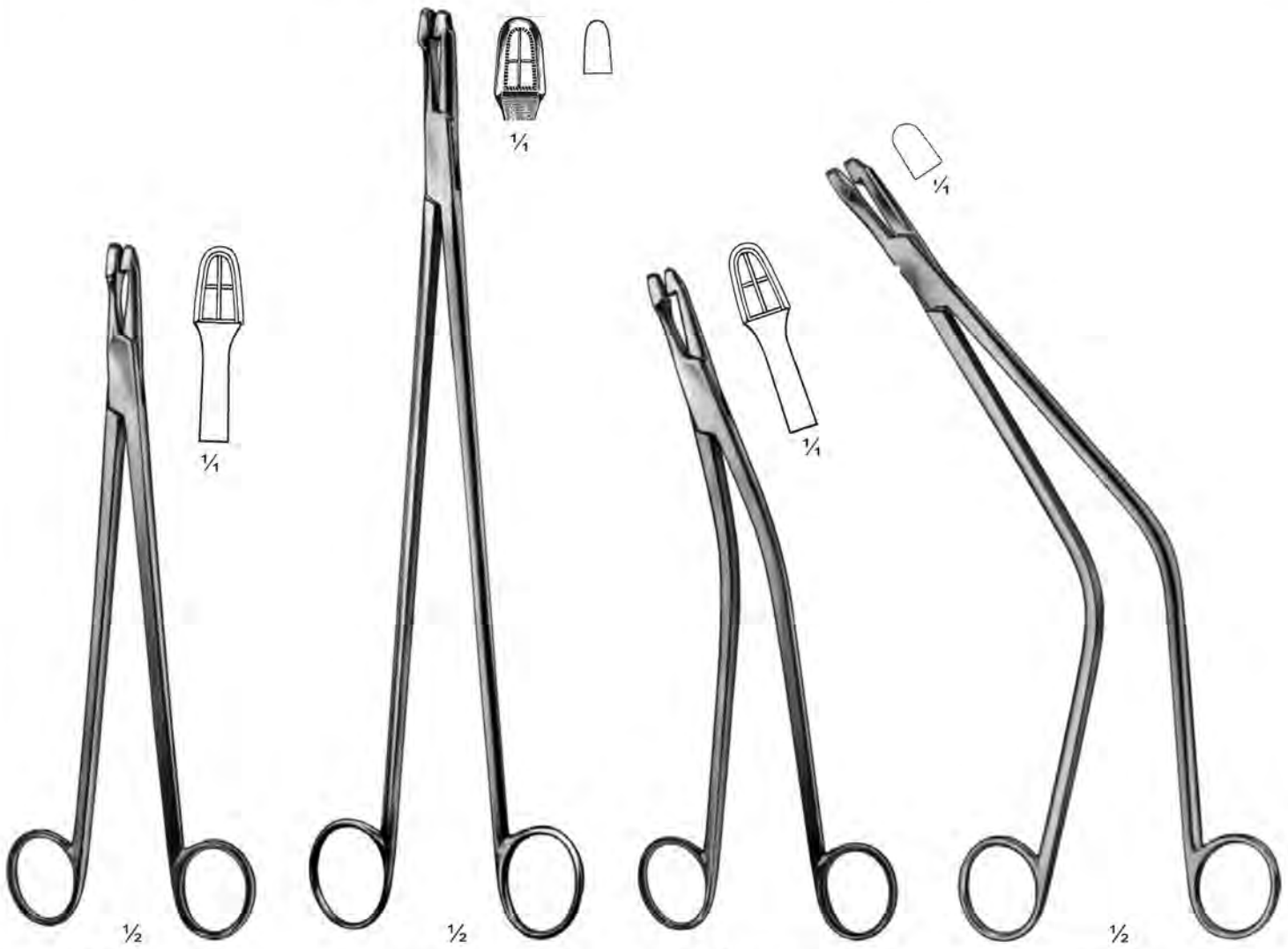

Schubert  
891-01-21  
21 cm / 8 1/4"

Schubert  
891-02-27  
27 cm / 10 1/2"

Schubert  
891-03-21  
21 cm / 8 1/4"

Schubert  
891-04-26  
26 cm / 10 1/4"

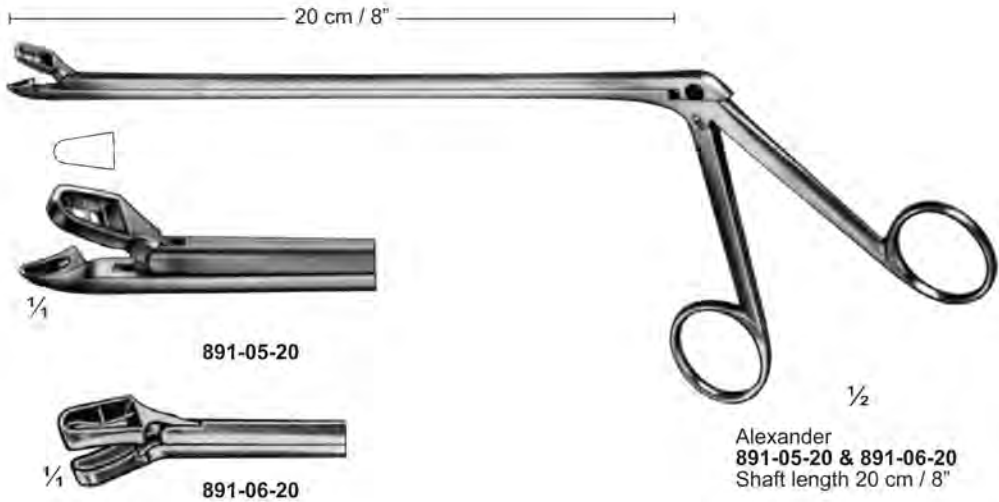

891-05-20

891-06-20

Alexander  
891-05-20 & 891-06-20  
Shaft length 20 cm / 8"

**Uterusfasazange  
Uterine Seizing Forceps  
Pincés hystérolabes**



Schubert  
892-01-23 Str  
892-02-23 Sideways cur  
23.5 cm / 9 1/4"



892-03-24  
4 mm

892-04-24  
6 mm

Schumacher-Van Doren  
892-03-24 & 892-04-24  
24 cm / 9 1/2"



Van Doren  
892-05-25  
25 cm / 10"



Van Doren  
892-06-27  
27 cm / 10 1/2"

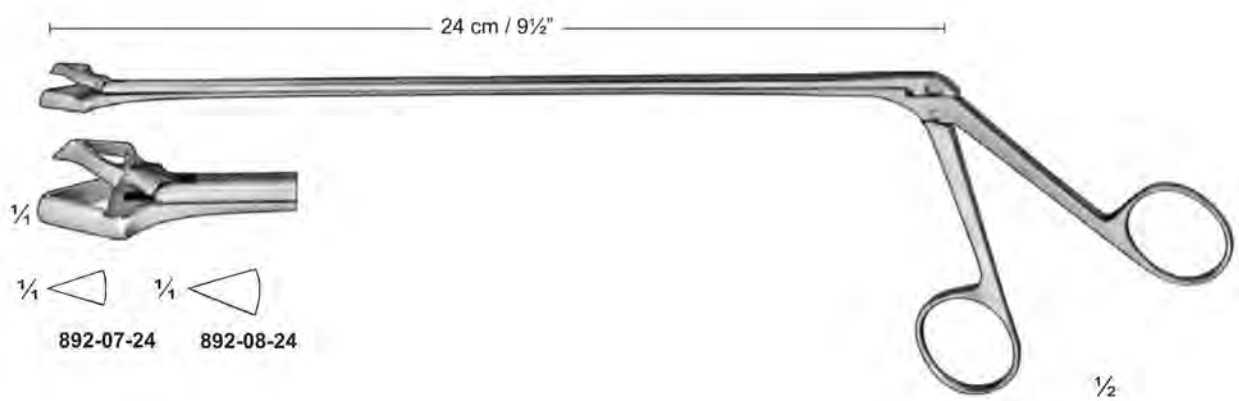

892-07-24    892-08-24

Schumacher  
892-07-24 & 892-08-24  
Shaft length 24 cm / 9 1/2"

**Uterusfasazange  
Uterine Seizing Forceps  
Pincès hystérolabes**



Van Doren  
893-01-25  
25 cm / 10"



Gaylor  
893-02-24  
24 cm / 9 1/2"



Thoms-Gaylor  
893-03-22 22 cm / 8 3/4"  
893-04-24 24 cm / 9 1/2"



Gellhorn  
893-05-23  
23 cm / 9"

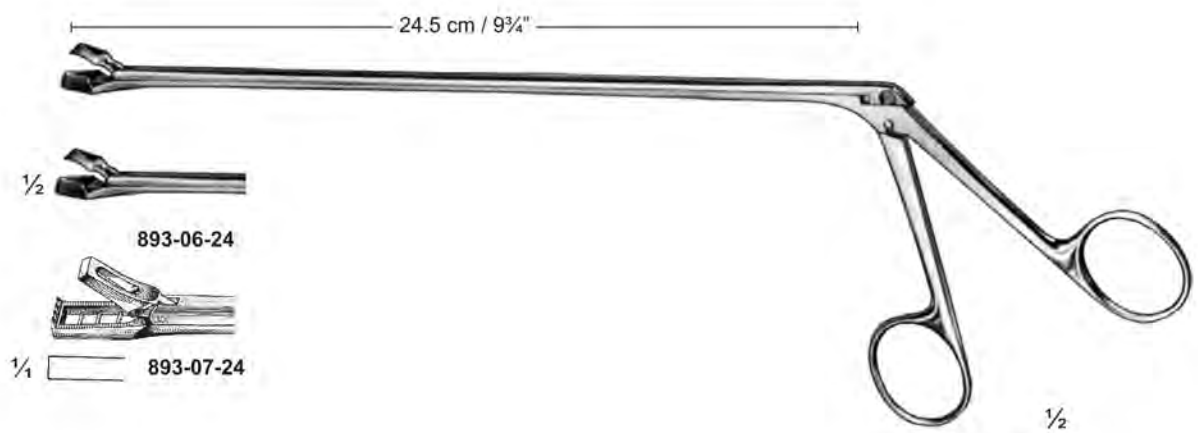

Kevorkian  
893-06-24 TO 893-07-24  
Shaft length 24.5 cm / 9 3/4"

**Uterusfasazange**  
**Uterine Seizing Forceps**  
**Pincès hystérolabes**

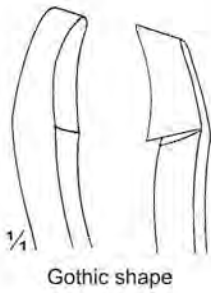

894-01-24  
2 mm

894-02-24  
2.4 mm

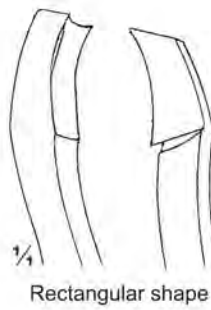
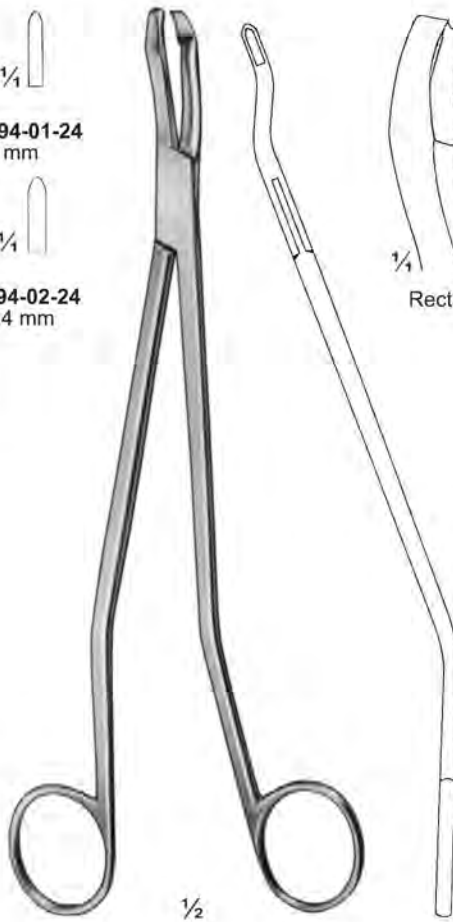

894-03-24  
2.4 mm



Faure  
 894-04-21 21 cm / 8 1/4"  
 894-05-24 24 cm / 9 1/2"



Tischler  
 894-06-27  
 27 cm / 10 1/2"

**Uterusfasazange  
Uterine Seizing Forceps  
Pincés hystérolabes**

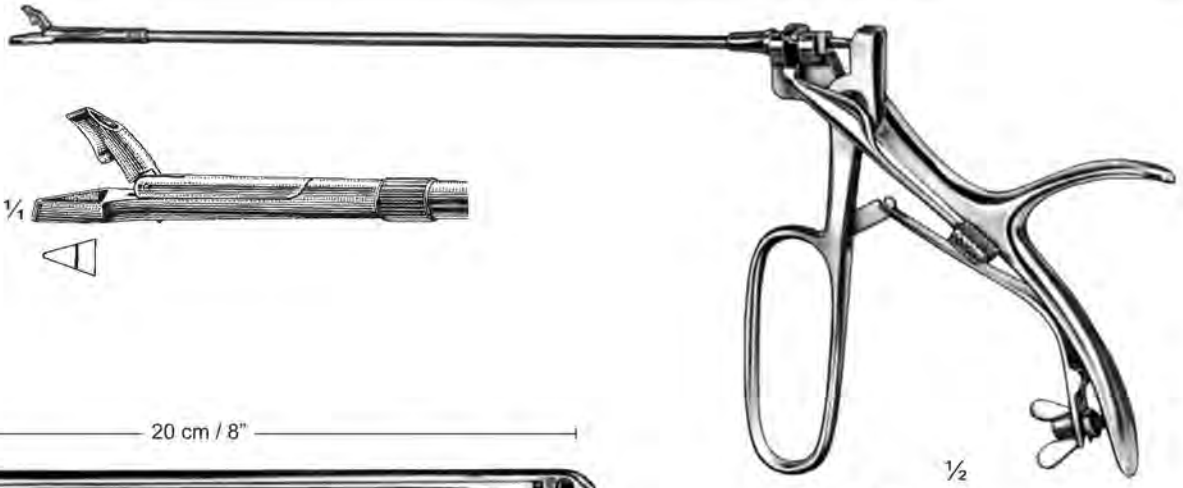

$\frac{1}{2}$   
Schumacher  
**895-01-00**  
With removeable tip

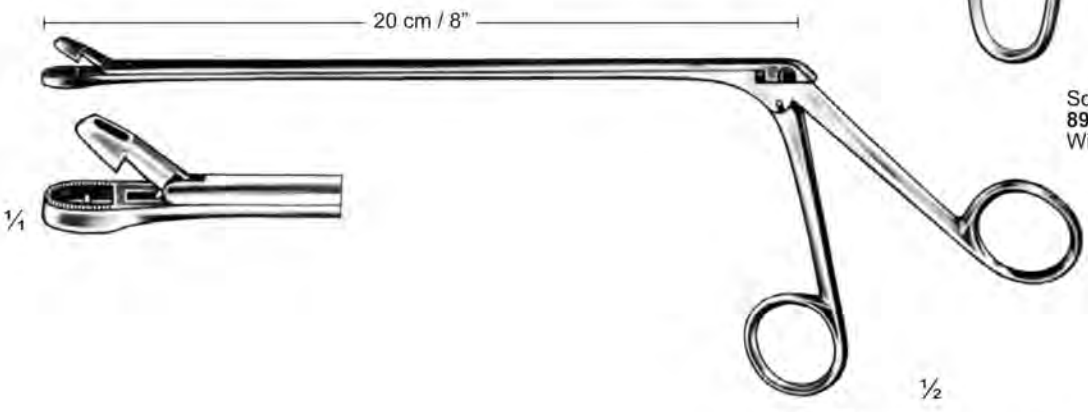

$\frac{1}{2}$   
Appendorf  
**895-02-20** Shaft length 20 cm / 8"  
**895-03-23** Shaft length 23 cm / 9"

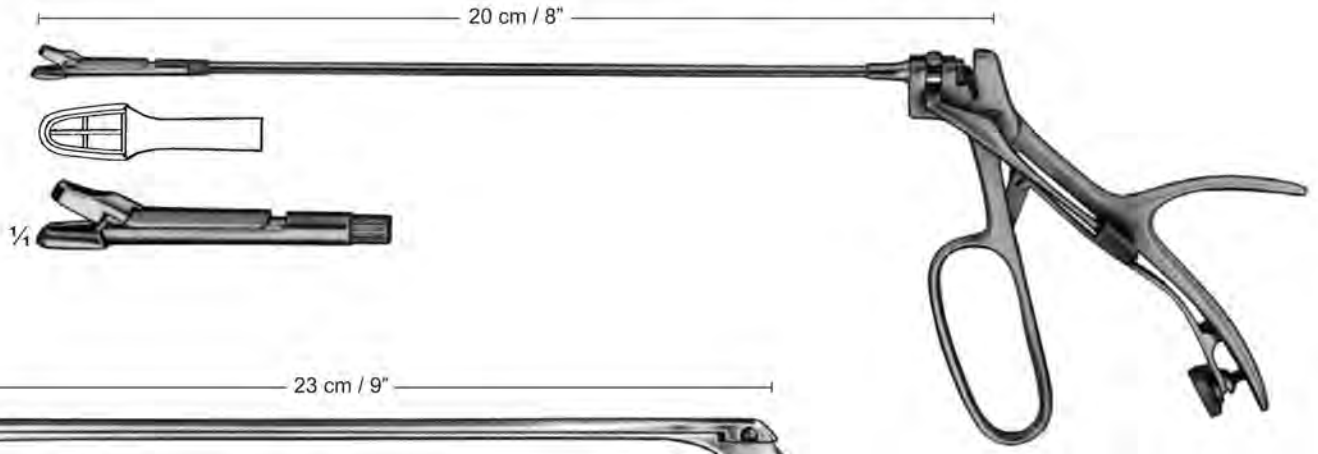

Eppendorf  
**895-04-20**  
Shaft length 20 cm / 8"

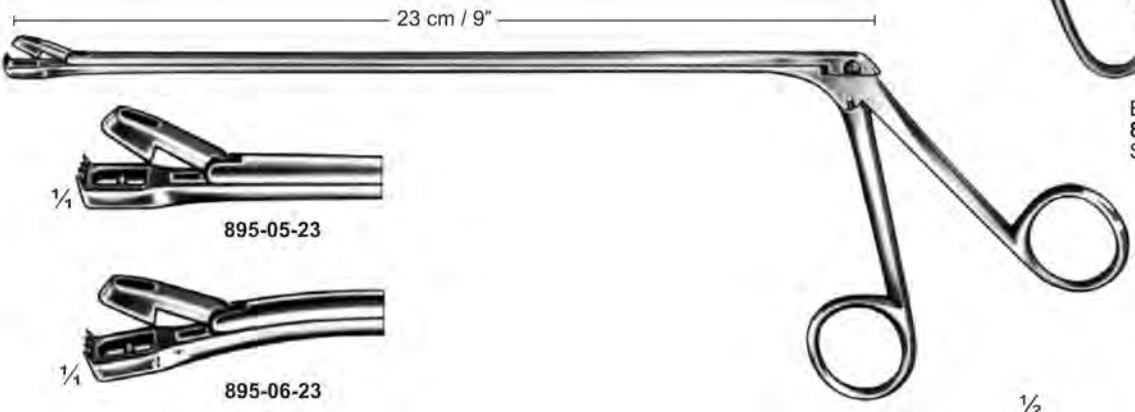

$\frac{1}{2}$   
Wittner  
**895-05-23 & 895-06-23**  
Shaft length 23 cm / 9"



**Uterusfasazange**  
**Uterine Seizing Forceps**  
**Pincès hystérolabes**

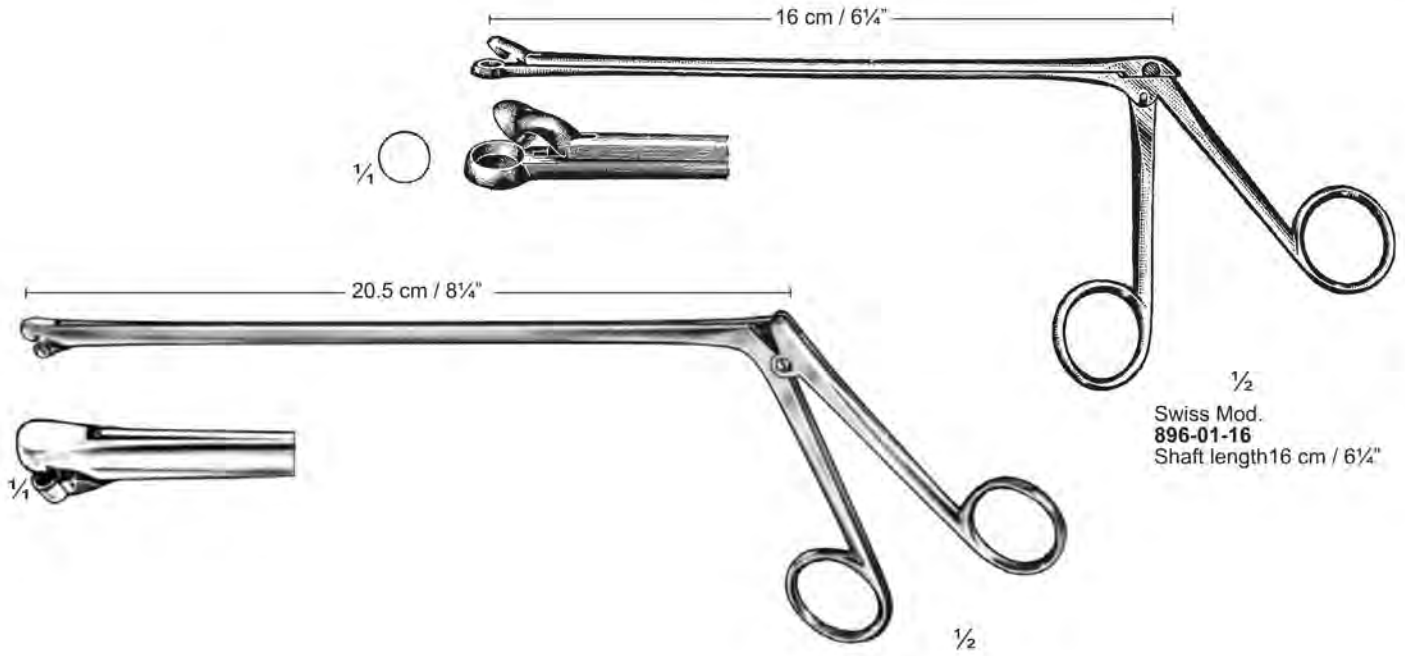

Swiss Mod.  
**896-01-16**  
 Shaft length 16 cm / 6 1/4"

Berger  
**896-02-20**  
 Shaft length 20.5 cm / 8 1/4"

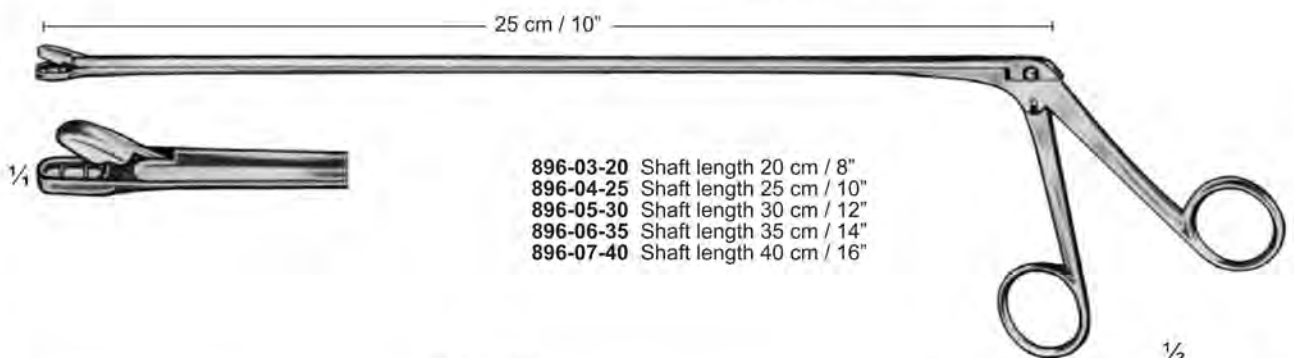

- 896-03-20** Shaft length 20 cm / 8"
- 896-04-25** Shaft length 25 cm / 10"
- 896-05-30** Shaft length 30 cm / 12"
- 896-06-35** Shaft length 35 cm / 14"
- 896-07-40** Shaft length 40 cm / 16"

Douay  
**896-03-20 To 896-07-40**

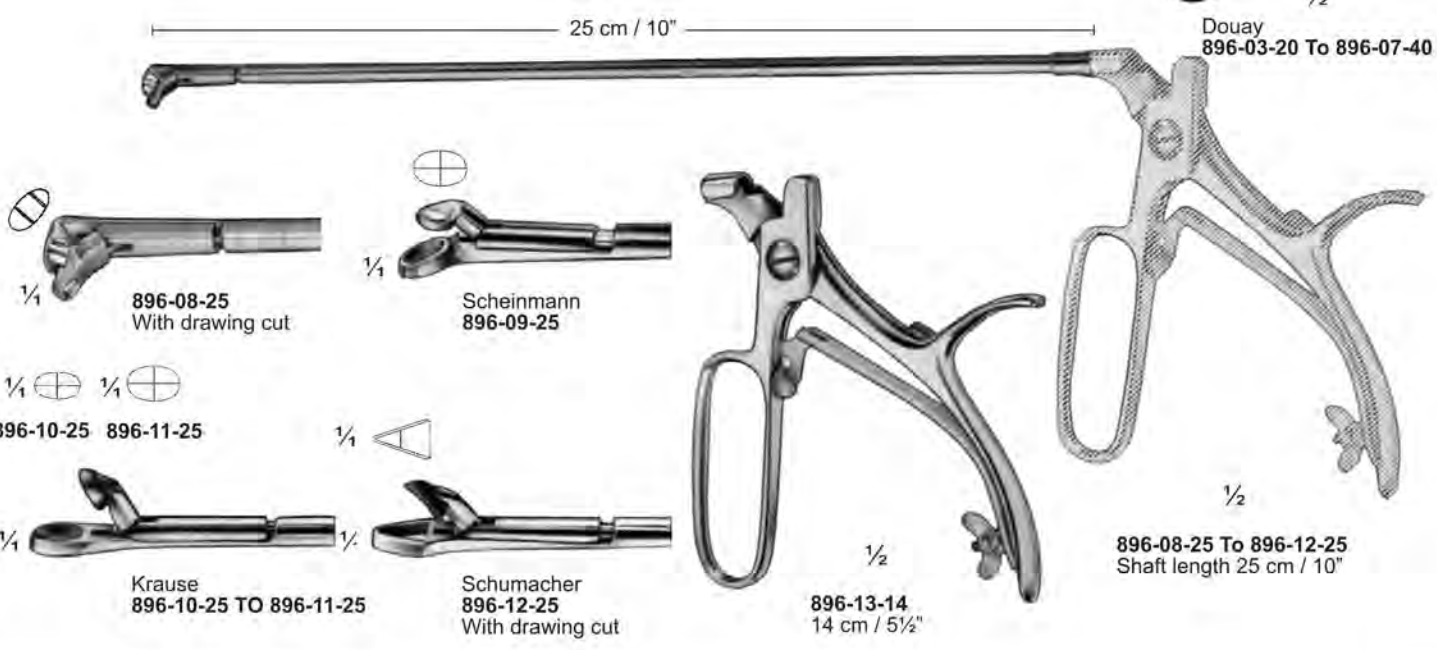

**896-08-25**  
 With drawing cut

Scheinmann  
**896-09-25**

**896-10-25** **896-11-25**

Krause  
**896-10-25 TO 896-11-25**

Schumacher  
**896-12-25**  
 With drawing cut

**896-13-14**  
 14 cm / 5 1/2"

**896-08-25 To 896-12-25**  
 Shaft length 25 cm / 10"

**Uterusfasazange  
Uterine Seizing Forceps  
Pincés hystérolabes**

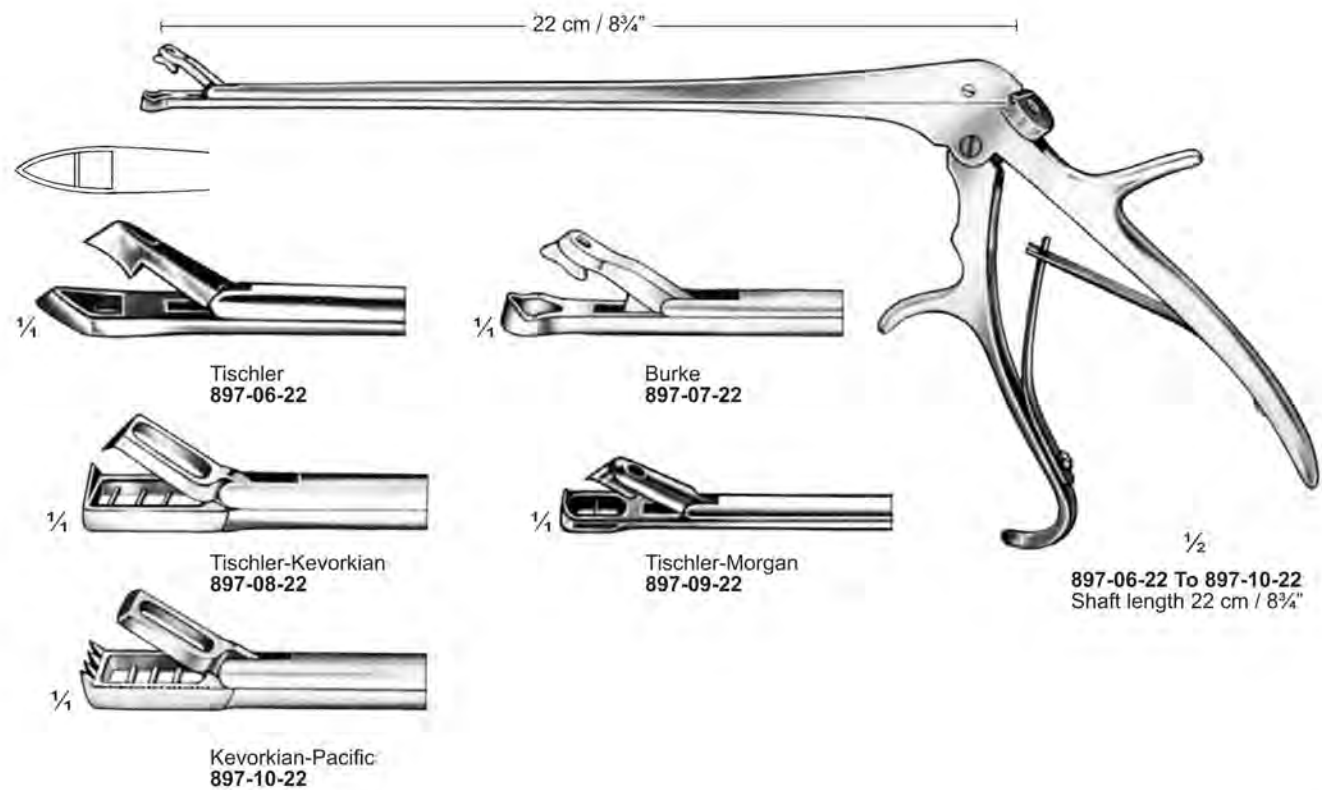
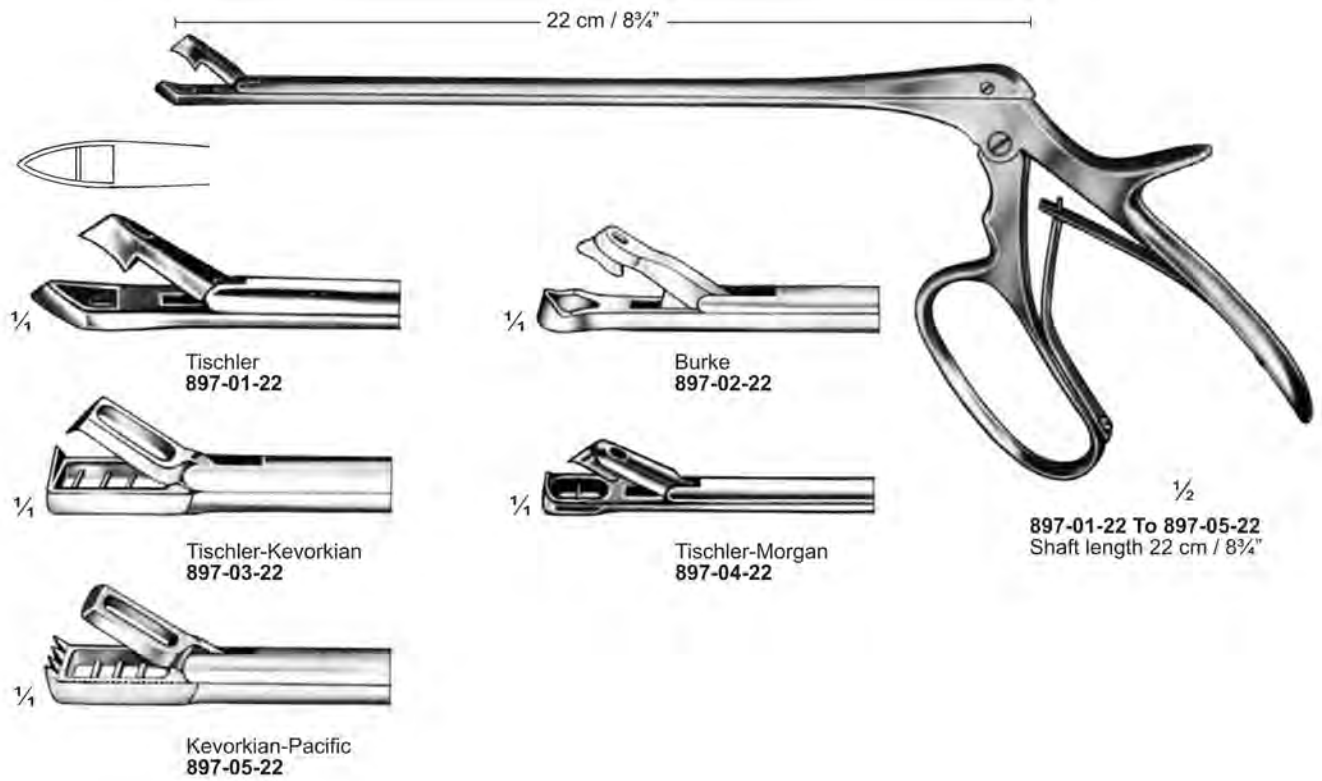

**Uterusfasazange  
Uterine Seizing Forceps  
Pincés hystérolabes**

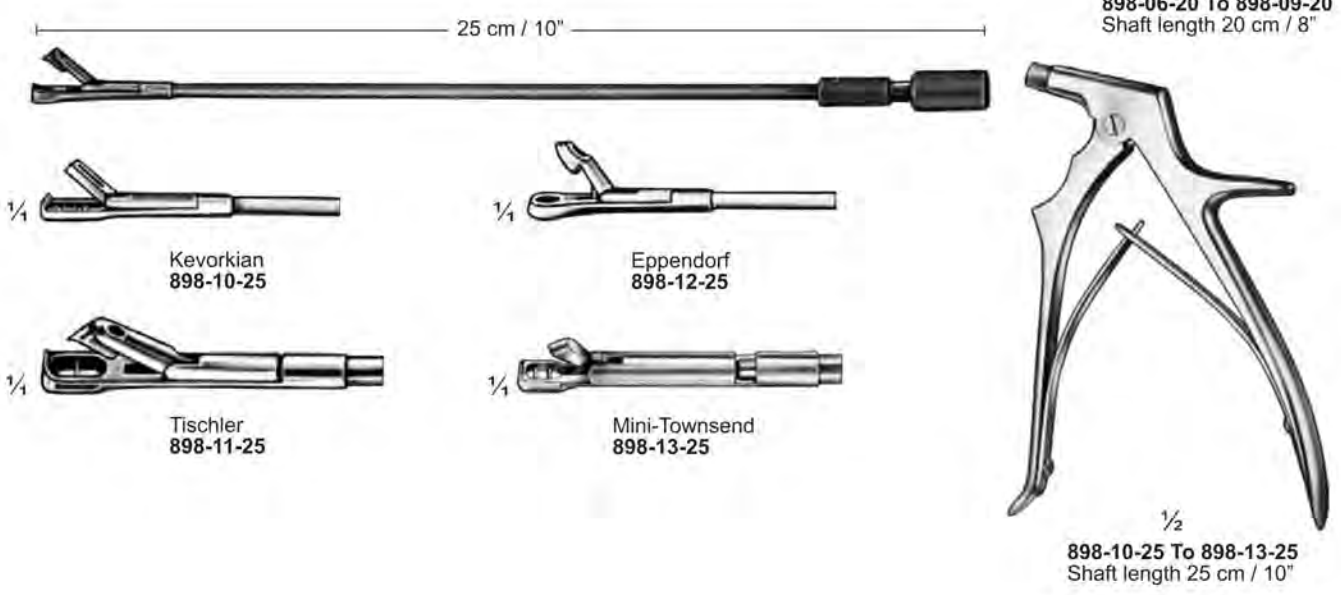
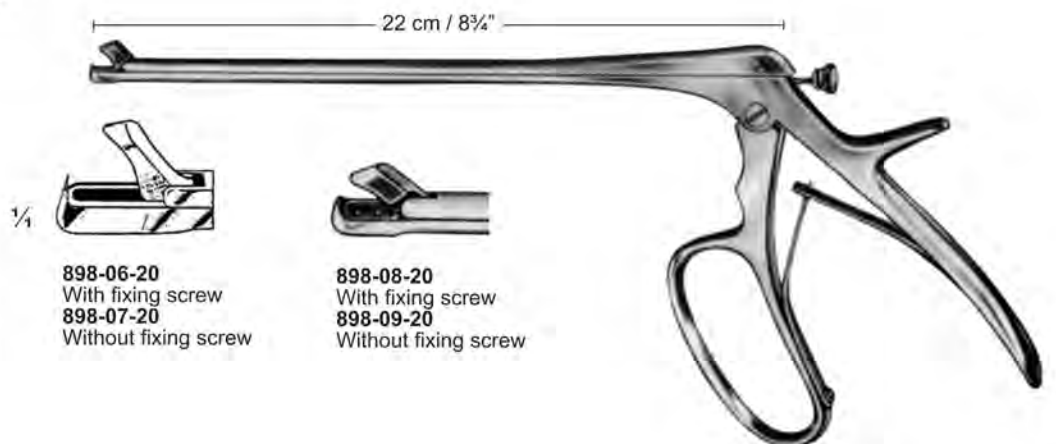
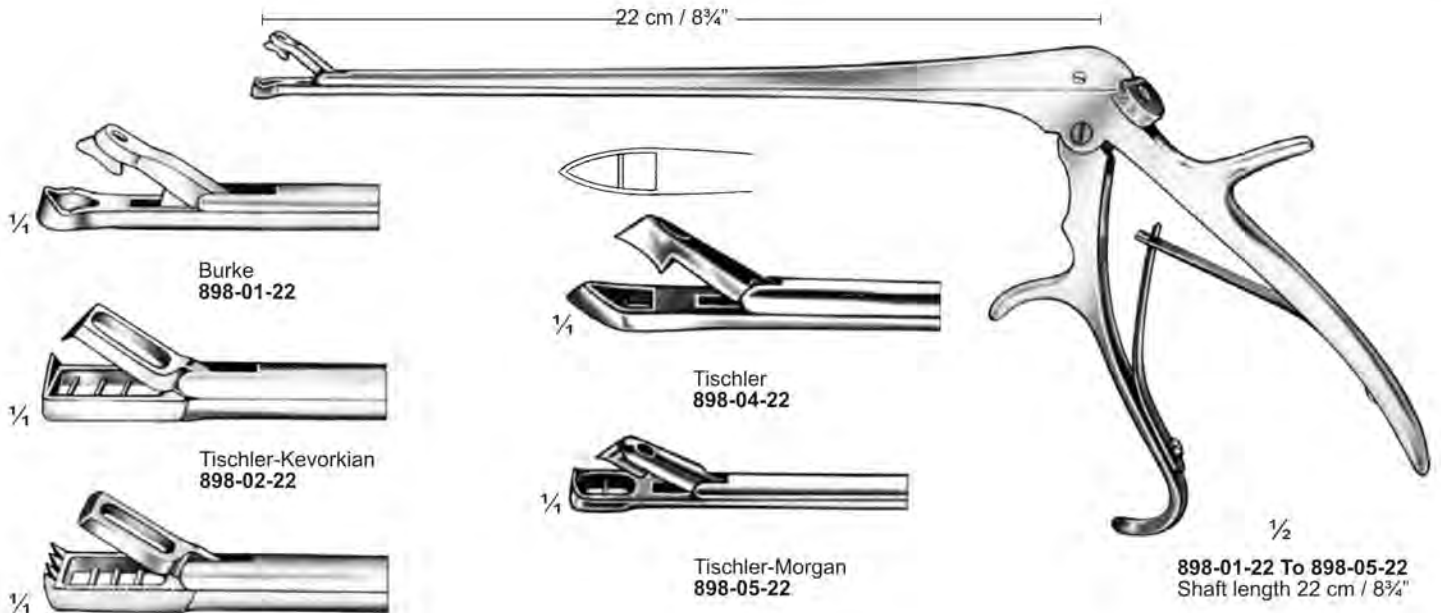

**Myomheber, Myommesser  
Myoma Screws, Myoma Knife  
Tracteurs pour fibromes, Evideur de fibromes**



1/2  
Segond  
899-01-27  
27 cm / 10 1/2"



1/4



1/2  
Segond  
899-02-27  
27 cm / 10 1/2"

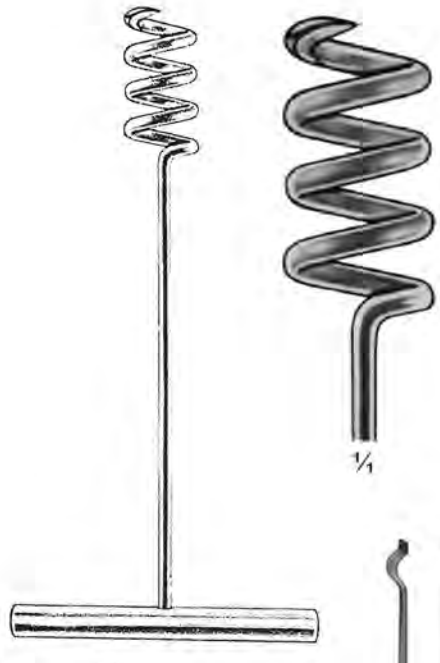

1/2  
Doyen  
899-03-17  
17 cm / 6 3/4"  
Ø 20 mm

1/4



1/2  
Doyen  
899-04-14  
14 cm / 5 1/2"  
Ø 29 mm



1/4



1/4  
899-05-20  
Ø 6 mm



1/4  
899-06-20  
Ø 8 mm



1/4  
899-07-20  
Ø 10 mm



1/2  
Neubuser  
899-05-20 To 899-07-20  
20 cm / 8"  
Tubal seizing forceps

**Uterussonden  
Uterine Sounds  
Hystéromètres**



1/2  
Mayo  
900-01-33  
33 cm / 13"  
Malleable



1/2  
Sims (Swiss Mod.)  
900-09-27  
27 cm / 10 1/2"  
Malleable



1/4



1/2  
Sims  
900-02-32 Fixed  
900-03-32 Malleable  
32 cm / 12 1/2"



1/2  
Simpson  
900-10-29  
29 cm / 11 1/2"  
Malleable



1/4  
900-04-30 Fixed  
900-05-30 Malleable  
30 cm / 12"



Emmet (Sims)  
900-11-30  
30 cm / 12"

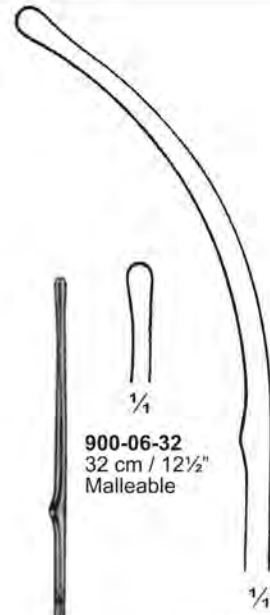

1/4  
900-06-32  
32 cm / 12 1/2"  
Malleable

1/4  
900-07-28  
28 cm / 11"  
Fixed



1/2  
Valleix  
900-12-25  
25 cm / 10"  
Graduated, With slider



1/2  
Collin  
900-08-28  
28 cm / 11"  
Graduated,  
With slider

**Tupferhalter ; Pinzas de hisopo  
Sponge Holding Forceps ; Pinze di tampone  
Porte tampon ; Fórceps swab**

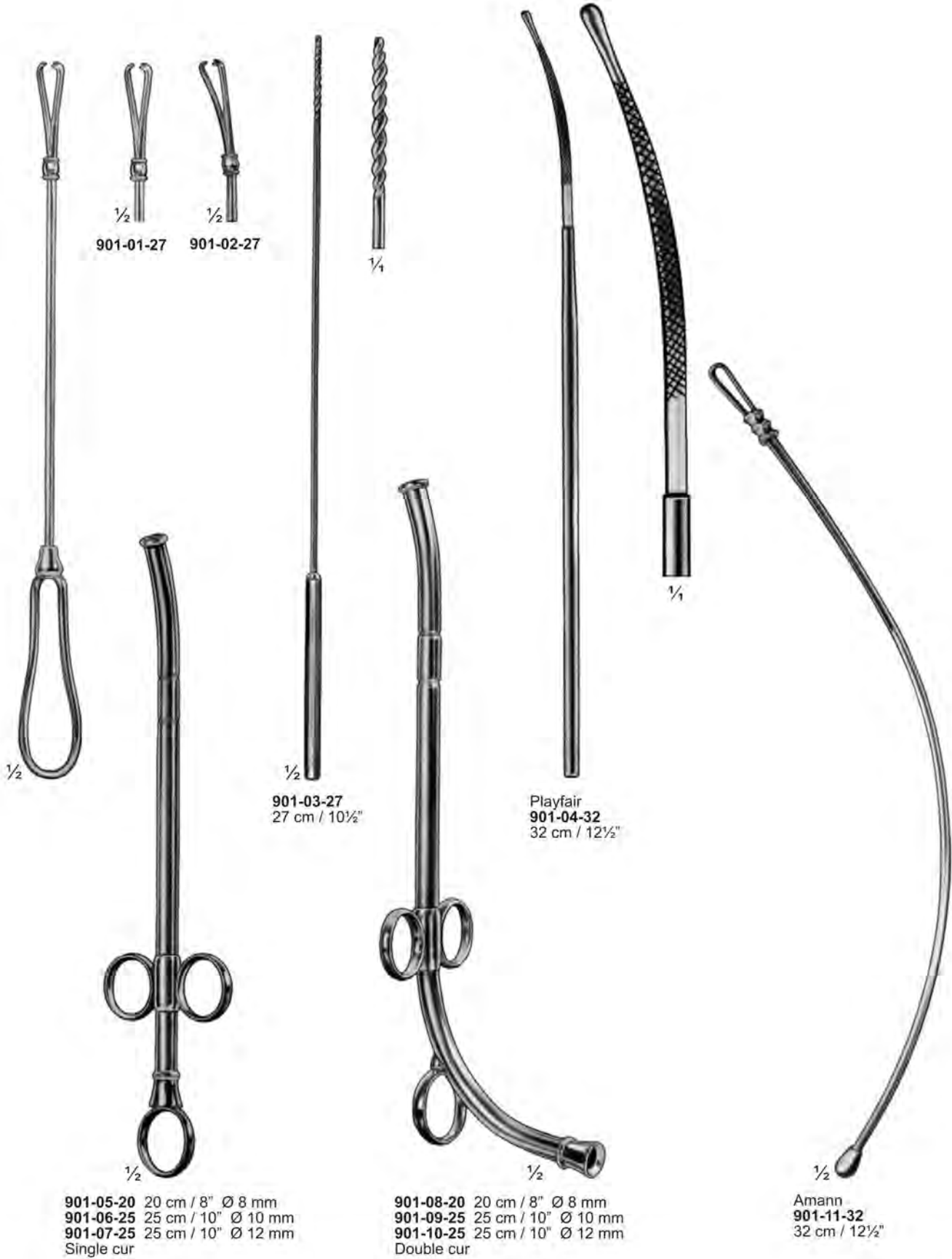

1/2      1/2      1/2  
901-01-27      901-02-27

1/4

1/4

1/2

1/2  
901-03-27  
27 cm / 10 1/2"

Playfair  
901-04-32  
32 cm / 12 1/2"

1/2  
901-05-20 20 cm / 8" Ø 8 mm  
901-06-25 25 cm / 10" Ø 10 mm  
901-07-25 25 cm / 10" Ø 12 mm  
Single cur

1/2  
901-08-20 20 cm / 8" Ø 8 mm  
901-09-25 25 cm / 10" Ø 10 mm  
901-10-25 25 cm / 10" Ø 12 mm  
Double cur

1/2  
Amann  
901-11-32  
32 cm / 12 1/2"



**Uterusdepressoren ; Depresores uterinos  
 Uterine Depressors ; Depressivi di uterina  
 Depresseurs utérins ; Depresores de uterino**



Braun  
 902-01-27  
 27 cm / 10½"

Braun  
 902-02-28 To 902-04-27



902-02-28  
 28.5 cm / 11¼"  
 15 mm

902-03-26  
 26 cm / 10¼"  
 25 mm

902-04-27  
 27 cm / 10½"  
 35 mm

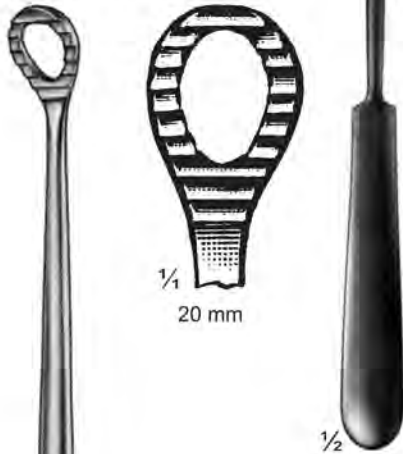

Sims  
 902-05-26  
 26 cm / 10¼"



Ayre  
 902-13-23  
 23 cm / 9"

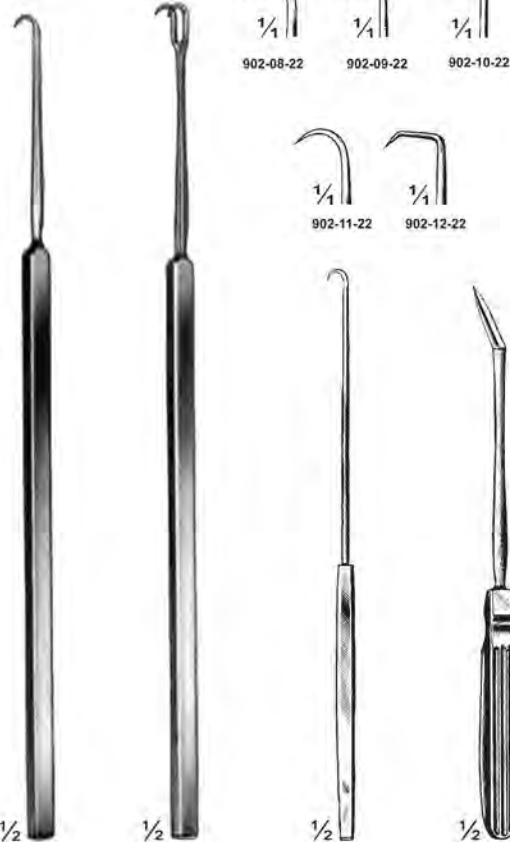

Simon  
 902-06-22  
 22 cm / 8¾"

Simon  
 902-07-22  
 22 cm / 8¾"

Emmet  
 902-08-22 To 902-12-22  
 22 cm / 8¾"

Ayre  
 902-13-23  
 23 cm / 9"

**Uterusdilatoren ; Dilatores uterinos  
Uterine Dilators ; Dilatori uterini  
Dilatateurs utérins ; Dilatores de uterino**



1/2

Ø mm	
903-01-01	1.0
903-02-02	2.0
903-03-03	3.0
903-04-04	4.0
903-05-05	5.0
903-06-06	6.0
903-07-07	7.0
903-08-08	8.0
903-09-09	9.0
903-10-10	10.0
903-11-11	11.0
903-12-12	12.0
903-13-13	13.0
903-14-14	14.0
903-15-15	15.0
903-16-16	16.0
903-17-17	17.0
903-18-18	18.0
903-19-19	19.0
903-20-20	20.0
903-21-21	21.0
903-22-22	22.0
903-23-23	23.0
903-24-24	24.0
903-25-25	25.0
903-26-26	26.0

Hegar  
903-01-01 To 903-48-22  
18 cm / 7"

With sloped handle  
903-49-26 Set of 26 pcs (903-01-01 To 903-26-26)  
903-50-17 Set of 17 pcs (903-27-01 To 903-43-17)  
903-51-22 Set of 22 pcs (903-27-01 To 903-48-22)

Ø mm	
903-27-01	1.5
903-28-02	2.5
903-29-03	3.5
903-30-04	4.5
903-31-05	5.5
903-32-06	6.5
903-33-07	7.5
903-34-08	8.5
903-35-09	9.5
903-36-10	10.5
903-37-11	11.5
903-38-12	12.5
903-39-13	13.5
903-40-14	14.5
903-41-15	15.5
903-42-16	16.5
903-43-17	17.5
903-44-18	18.5
903-45-19	19.5
903-46-20	20.5
903-47-21	21.5
903-48-22	22.5

Hegar  
903-52-01 To 903-99-22  
16 cm / 6 1/4"

With grooved handle  
903-100-26 Set of 26 pcs (903-52 To 903-77)  
903-101-17 Set of 17 pcs (903-78 To 903-94)  
903-102-22 Set of 22 pcs (903-78 To 903-99)



1/2



Hegar  
903-103-26 Set of 26 pcs (903-01 To 903-26 or 903-52 To 903-77)  
903-104-17 Set of 17 pcs (903-27 To 903-43 or 903-78 To 903-94)  
903-105-22 Set of 22 pcs (903-27 To 903-48 or 903-78 To 903-99)  
Packed in metal case 330 X 220 X 80 mm





**Uterusdilatoren ; Dilataores uterinos  
Uterine Dilators ; Dilatatori uterini  
Dilatateurs utérins ; Dilataores de uterino**



1/2

	∅ mm
904-01-01	1.0/2.0
904-02-03	3.0/4.0
904-03-05	5.0/6.0
904-04-07	7.0/8.0
904-05-09	9.0/10.0
904-06-11	11.0/12.0
904-07-13	13.0/14.0
904-08-15	15.0/16.0
904-09-17	17.0/18.0
904-10-19	19.0/20.0
904-11-21	21.0/22.0
904-12-23	23.0/24.0
904-13-25	25.0/26.0



1/2

1/2

1/2

1/2

1/2

1/2

1/2

1/2

Hegar  
904-01-01 To 904-13-25  
19 cm / 7 1/2"

Hegar  
904-14-08  
Set of 8 pcs (904-02-03 To 904-09-17)



Hegar  
904-15-8  
Set of 8 pcs (904-02-03 To 904-09-17)  
Packed in canvas roll



Hegar  
904-16-13  
Set of 13 pcs (904-01-01 To 904-13-25)  
Packed in metal case with hinged lid



**Uterusdilatoren ; Dilataores uterinos  
Uterine Dilators ; Dilatatori uterini  
Dilatateurs utérins ; Dilataores de uterino**



Hank <b>905-01-5</b> Fig 9/10 Ø 4.5/5 mm	Hank <b>905-02-6</b> Fig 11/12 Ø 5.5/6 mm	Hank <b>905-03-7</b> Fig 13/14 Ø 6.5/7 mm	Hank <b>905-04-8</b> Fig 15/16 Ø 7.5/8 mm	Hank <b>905-05-9</b> Fig 17/18 Ø 8.5/9 mm	Hank <b>905-06-10</b> Fig 19/20 Ø 9.5/10 mm
---	--	--	--	--	--

**905-07-06** Set of 6 pcs (905-01-05 To 905-06-10)  
26 cm / 10 1/4"



Hank  
**905-08-06** Packed in metal case  
**905-09-06** Packed in canvas roll  
Set of 6 pcs (905-01-05 To 905-06-10)



Pratt  
**905-10-05** Ø 4.5/5 mm  
**905-11-06** Ø 5.6/6.3 mm  
**905-12-07** Ø 7.0/7.6 mm  
**905-13-09** Ø 8.3/9 mm  
**905-14-10** Ø 9.6/10.3 mm  
**905-15-11** Ø 11/11.6 mm  
**905-16-13** Ø 12.3/13 mm  
**905-17-14** Ø 13.6/14.3 mm

**905-18-08**  
Set of 8 pcs  
(905-10-05 To 905-17-14)

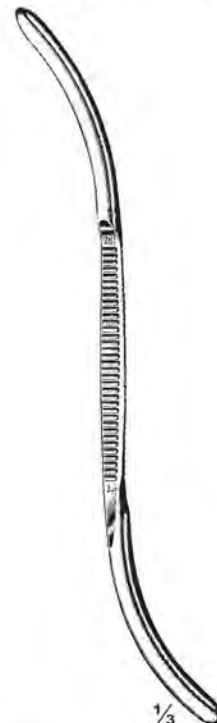

Pratt  
**905-19-05** Ø 4.5/5 mm  
**905-20-06** Ø 5.5/6 mm  
**905-21-07** Ø 6.5/7 mm  
**905-22-08** Ø 7.5/8 mm  
**905-23-09** Ø 8.5/9 mm  
**905-24-10** Ø 9.5/10 mm

**905-25-06**  
Set of 6 pcs  
(905-19-05 To 905-25-10)



Jolly  
**905-26-07** Ø 3/7 mm  
**905-27-09** Ø 5/9 mm  
**905-28-12** Ø 7/12 mm  
**905-29-15** Ø 9/15 mm  
**905-30-18** Ø 12/18 mm  
**905-31-21** Ø 15/21 mm  
**905-32-24** Ø 18/24 mm

**905-33-05**  
Set of 5 pcs  
(905-26-07 To 905-30-18)  
**905-34-07**  
Set of 7 pcs  
(905-26-07 To 905-32-24)

**Uterusdilatoren ; Dilataores uterinos  
 Uterine Dilators ; Dilatatori uterini  
 Dilatateurs utérins ; Dilataores de uterino**



Sims  
 906-01-29  
 29 cm / 11½"



Goodell  
 906-02-28 28 cm / 11"  
 906-03-34 34 cm / 13½"



Wylie  
 906-04-29 TO 906-05-29  
 29 cm / 11½"

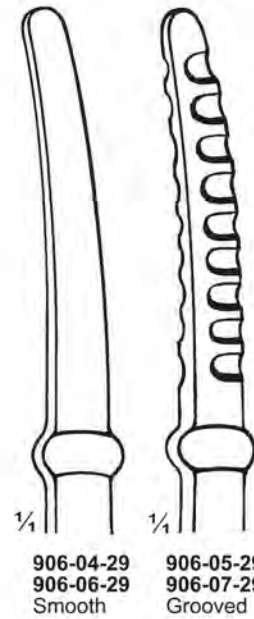

Wylie  
 906-06-29 TO 906-07-29  
 29 cm / 11½"

**Biopsieküretten ; Curetas para biopsia  
 Uterine Biopsy Curettes ; Curette di biopsia  
 Curettes pour biopsie ; Curetas uterines**

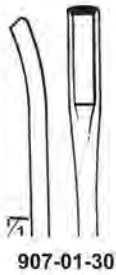

907-01-30

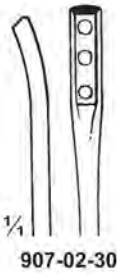

907-02-30



1/2  
 Kevorkian  
 907-01-30 TO  
 907-02-30  
 30 cm / 12"



1/2  
 907-06-27  
 27 cm / 10 1/2"  
 Malleable



1/2  
 Novak  
 907-03-23  
 23 cm / 9"  
 Ø 4 mm



1/2  
 Reich-Nechtow  
 907-07-22  
 22 cm / 8 3/4"



1/2  
 Novak-Schoeckaert  
 907-04-24  
 24 cm / 9 1/2"

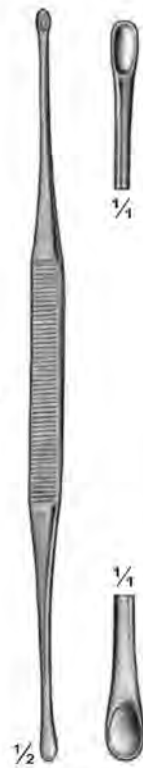

1/2  
 Asch  
 907-08-20  
 20 cm / 8"  
 Malleable



1/2  
 Randall  
 907-05-24  
 24 cm / 9 1/2"  
 Ø 4 mm



**Biopsieküretten ; Curetas para biopsia  
 Uterine Biopsy Curettes ; Curette di biopsia  
 Curettes pour biopsie ; Curetas uterines**



908-01-04  
4 mm

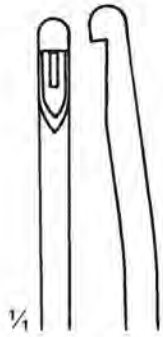

908-02-05  
5 mm



1/4



908-04-05  
Ø 5.7 mm



908-05-08  
Ø 8 mm



908-06-11  
Ø 11 mm



1/2

Mod. Muenchen  
908-01-04 & 908-02-05  
27 cm / 10 1/2"



1/4



1/4

908-07-05  
5 mm



1/4

908-08-06  
6 mm



1/4

908-09-07  
7 mm



1/4

908-10-08  
8 mm



Genell  
908-03-28  
28 cm / 11"

1/2

Gusberg  
908-04-05 To 908-06-11  
24 cm / 9 1/2"



1/4



1/2

Mod. Berlin  
908-11-27  
27 cm / 10 1/2"

Kelly-Gray  
908-07-05 To 908-10-08  
24 cm / 9 1/2"



**Biopsieküretten ; Curetas para biopsia  
Uterine Biopsy Curettes ; Curette di biopsia  
Curettes pour biopsie ; Curetas uterines**

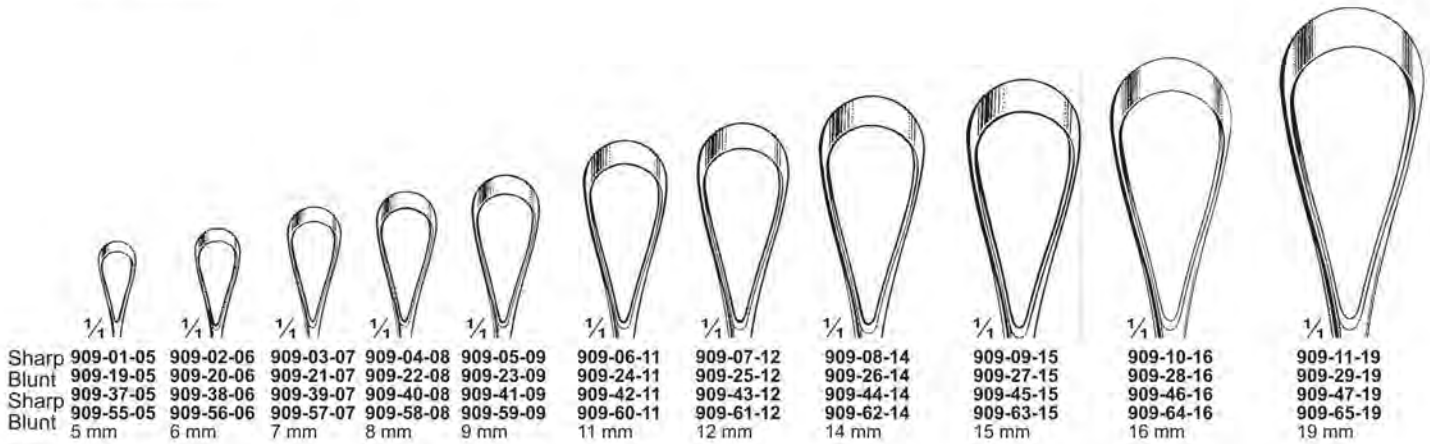



**Biopsieküretten ; Curetas para biopsia  
Uterine Biopsy Curettes ; Curette di biopsia  
Curettes pour biopsie ; Curetas uterines**

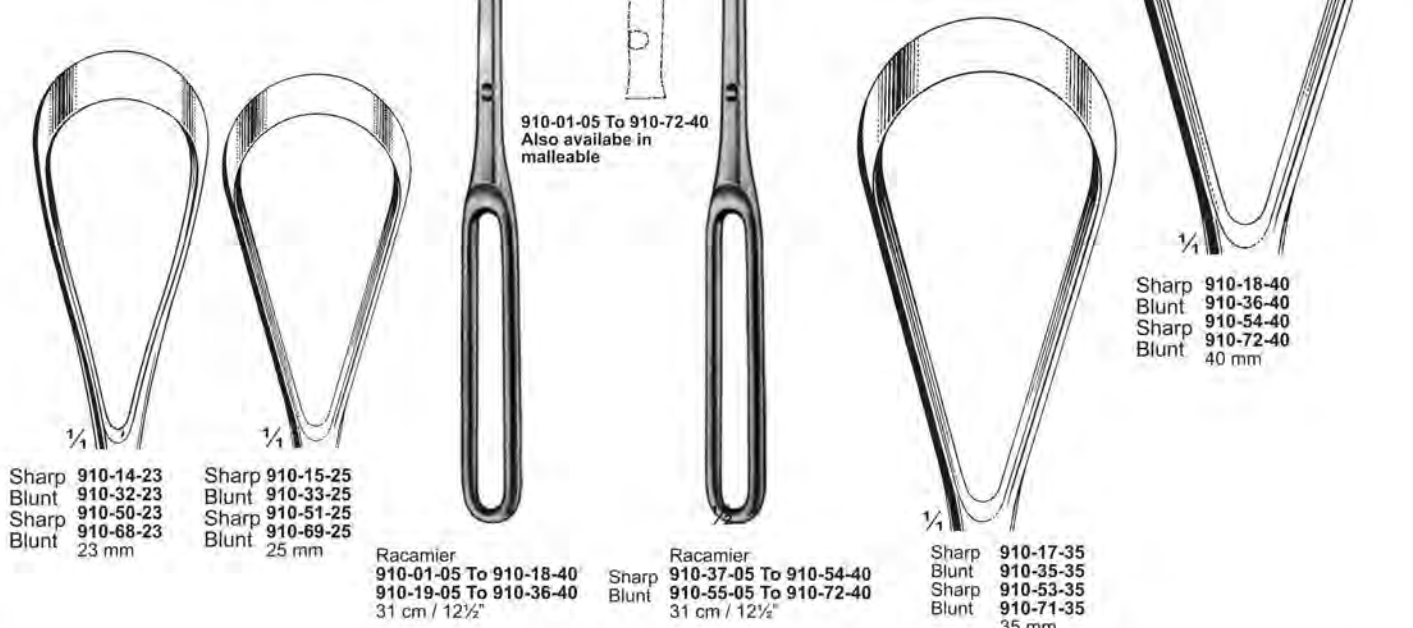
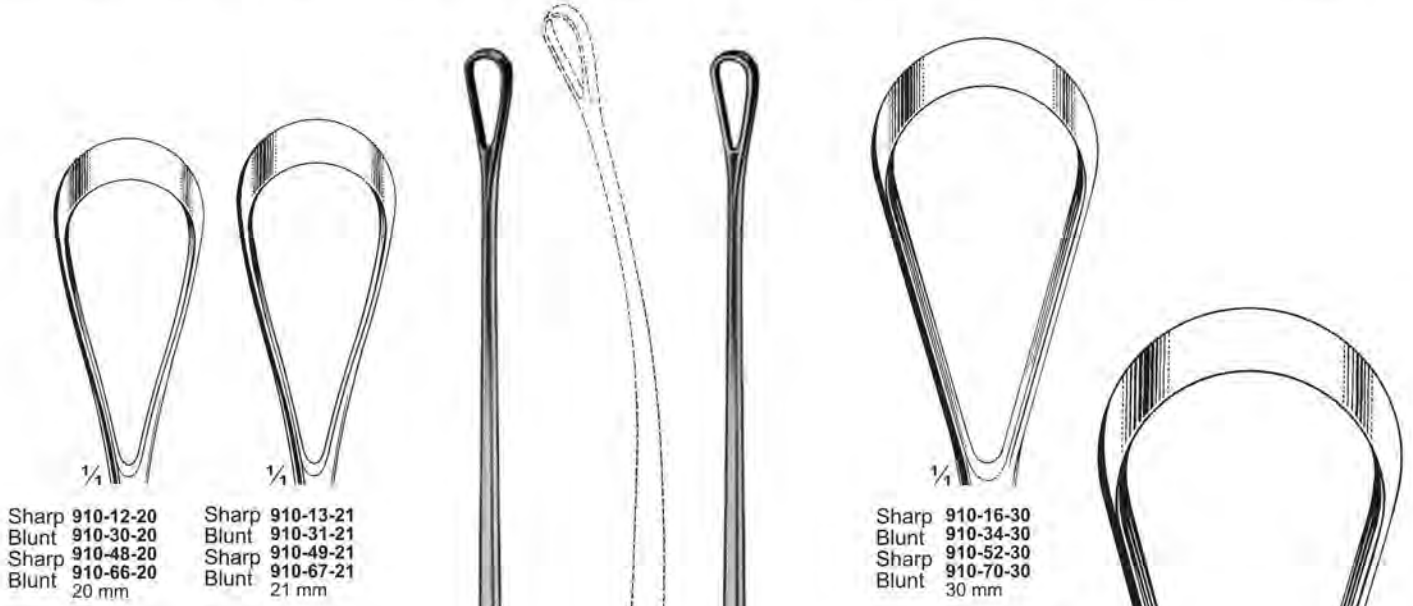
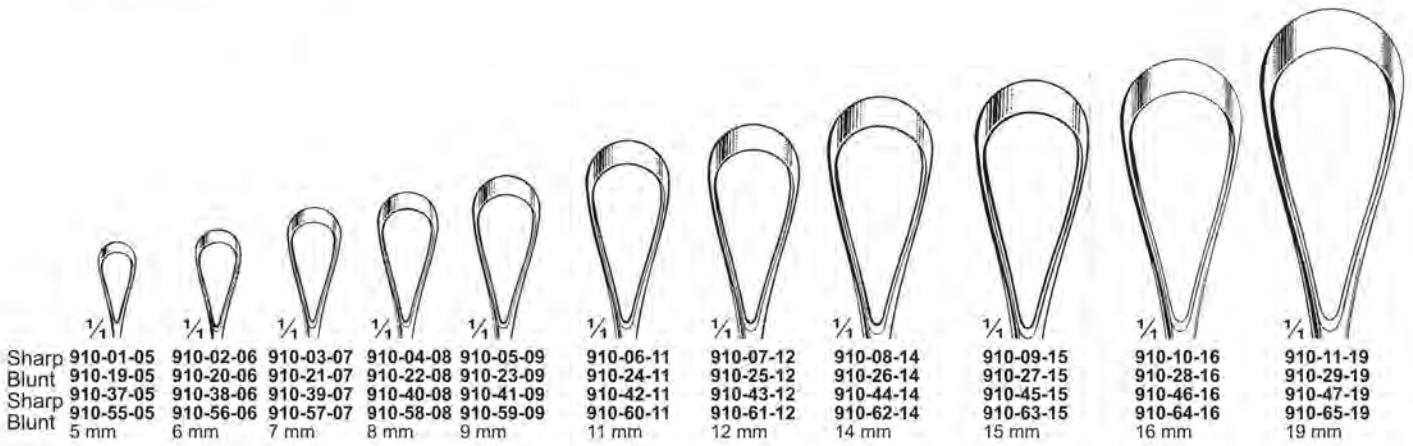

**Biopsieküretten  
Uterine Biopsy Currettes  
Currettes pour biopsie**



Fig. 1  
Sharp 911-01-07  
Blunt 911-07-07



Fig. 2  
911-02-08  
911-08-08



Fig. 3  
911-03-09  
911-09-09



Fig. 4  
911-04-11  
911-10-11



Fig. 5  
911-05-12  
911-11-12



Fig. 6  
911-06-14  
911-12-14

Sharp 911-13-07  
Blunt 911-19-07

911-14-08  
911-20-08

911-15-09  
911-21-09

911-16-11  
911-22-11

911-17-12  
911-23-12

911-18-14  
911-24-14

Sharp 911-25-07  
Blunt 911-31-07  
7 mm

911-26-08  
911-32-08  
8 mm

911-27-09  
911-33-09  
9 mm

911-28-11  
911-34-11  
11 mm

911-29-12  
911-35-12  
12 mm

911-30-14  
911-36-14  
14 mm



Sims  
911-01-07 To 911-06-14 Sharp  
911-07-07 To 911-12-14 Blunt  
26 cm / 10 1/4"



Sims  
911-13-07 To 911-18-14 Sharp  
911-19-07 To 911-24-14 Blunt  
26 cm / 10 1/4"



911-01-07 To 911-36-14  
Also available in  
malleable



Sims  
911-25-07 To 911-30-14 Sharp  
911-31-07 To 911-36-14 Blunt  
26 cm / 10 1/4"



Sims (Herrera)  
911-37-25 Sharp  
25 cm / 10"



**Biopsieküretten  
Uterine Biopsy Currettes  
Curettes pour biopsie**



	Fig. 0	Fig. 1	Fig. 2
Sharp	912-01-10	912-02-11	912-03-13
Blunt	912-08-10	912-09-11	912-10-13
Sharp	912-15-10	912-16-11	912-17-13
Blunt	912-22-10	912-23-11	912-24-13
	10 mm	11 mm	13 mm



Bumm  
912-01-15 To 912-07-21 Sharp  
912-08-15 To 912-14-21 Blunt  
29 cm / 11½"

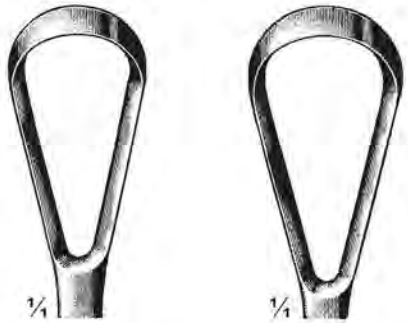

	Fig. 3	Fig. 4
Sharp	912-04-15	912-05-17
Blunt	912-11-15	912-12-17
Sharp	912-18-15	912-19-17
Blunt	912-25-15	912-26-17
	15 mm	17 mm

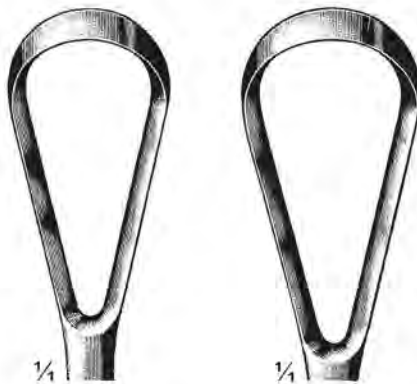
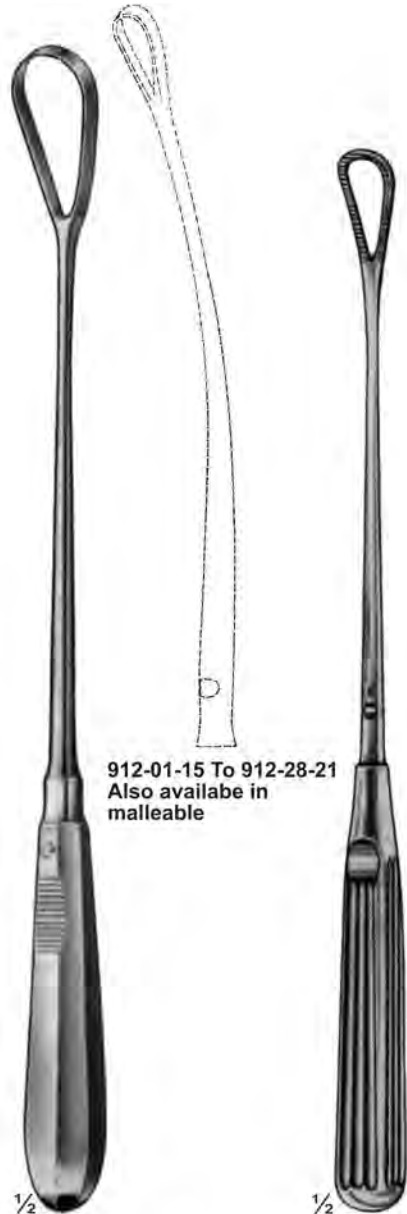

	Fig. 5	Fig. 6
Sharp	912-06-19	912-07-21
Blunt	912-13-19	912-14-21
Sharp	912-20-19	912-21-21
Blunt	912-27-19	912-28-21
	19 mm	21 mm



912-01-15 To 912-28-21  
Also available in malleable

Bumm  
912-15-15 To 912-21-21 Sharp  
912-22-15 To 912-28-21 Blunt  
31 cm / 12¼"



912-29-10  
10 mm



912-30-12  
12 mm



912-31-14  
14 mm

Greene  
912-29-10 To 912-31-14 Blunt  
28 cm / 11"  
Malleable



**Biopsieküretten  
Uterine Biopsy Currettes  
Currettes pour biopsie**

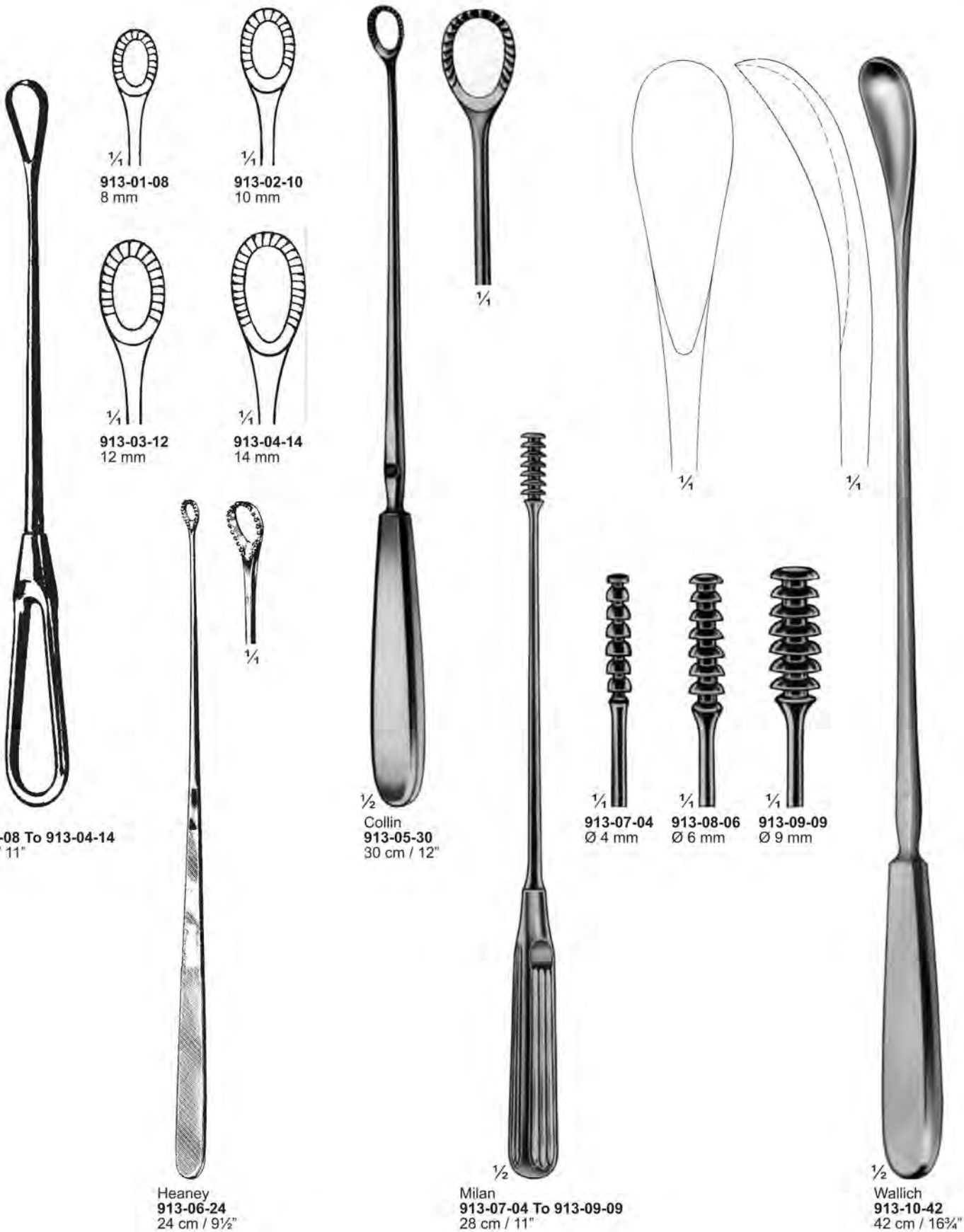

Collin  
913-01-08 To 913-04-14  
28 cm / 11"

Heaney  
913-06-24  
24 cm / 9½"

½  
Collin  
913-05-30  
30 cm / 12"

½  
Milan  
913-07-04 To 913-09-09  
28 cm / 11"

¼  
913-07-04 Ø 4 mm  
¼  
913-08-06 Ø 6 mm  
¼  
913-09-09 Ø 9 mm

½  
Wallich  
913-10-42  
42 cm / 16¾"

**Biopsieküretten**  
**Uterine Biopsy Curettes**  
**Curettes pour biopsie**



1/4  
**914-01-28**  
**914-07-28**  
**914-13-28**



1/4  
**914-02-28**  
**914-08-28**  
**914-14-28**



1/4  
**914-03-28**  
**914-09-28**  
**914-15-28**



1/4  
**914-04-28**  
**914-10-28**  
**914-16-28**



1/4  
**914-05-28**  
**914-11-28**  
**914-17-28**



1/4  
**914-06-28**  
**914-12-28**  
**914-18-28**



1/4



1/4



1/4



1/4



1/2

**Thomas**  
**914-01-28 To 914-06-28**  
 28 cm / 11"  
 Malleable, Blunt

1/2

**Thomas**  
**914-07-28 To 914-12-28**  
 28 cm / 11"  
 Malleable, Blunt

**Thomas**  
**914-13-28 To 914-18-28**  
 28 cm / 11"  
 Malleable, Blunt



1/4



1/4

**Blake**  
**914-19-27**  
 27 cm / 10 1/2"  
 Sh/Bl



1/4

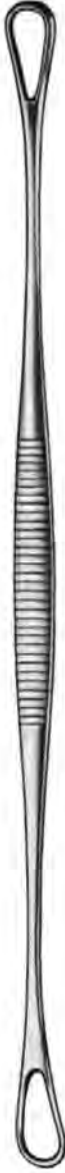

1/4

**Zaufel (Blake)**  
**914-20-31**  
 31 cm / 12 1/4"  
 Sh/Bl

**Biopsieküretten  
Uterine Biopsy Curettes  
Curettes pour biopsie**



Sims  
915-01-01 To 915-05-05  
28 cm / 11"  
Sharp  
Malleable

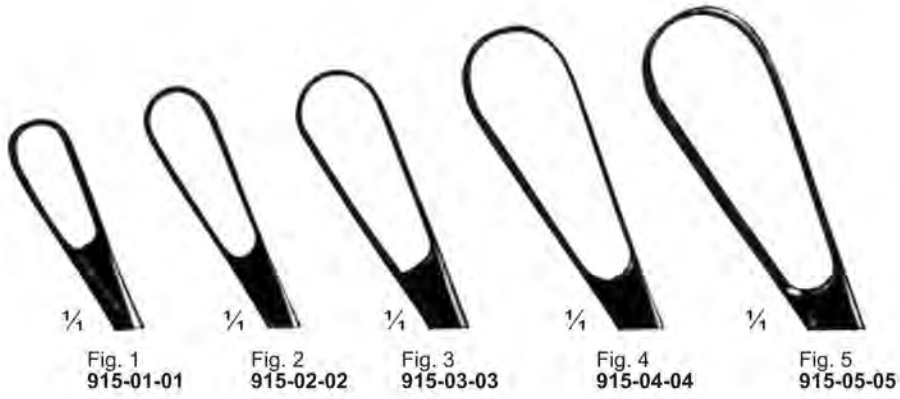

J. O. M. W Type  
915-06-04 To 915-11-15  
28 cm / 11"

**Biopsieküretten  
Uterine Biopsy Curettes  
Curettes pour biopsie**



Fig. 2  
916-01-08  
8 mm

Fig. 4  
916-02-11  
11 mm

Fig. 6  
916-03-14  
14 mm



Recamier (Sims)  
916-01-08 To 916-03-14  
30 cm / 12"



916-04-08  
8 mm

916-05-08  
8 mm  
Sharp

916-06-10  
10 mm  
Blunt



916-04-08 To 916-06-10  
30 cm / 12"  
With handle



916-07-30  
30 cm / 12"  
Complete set consisting  
1 Handle and 3 curettes



Hildebrandt  
916-08-21  
21 cm / 8 1/4"



Bozemann-Fritsch  
916-09-08 Ø 8 mm  
916-10-10 Ø 10 mm  
35 cm / 14"

**Biopsieküretten  
Uterine Biopsy Currettes  
Curettes pour biopsie**



**917-01-04**  
28 cm / 11"  
Ø 4 mm

**917-02-03**  
28 cm / 11"  
Ø 3 mm

**917-03-04**  
28 cm / 11"  
Ø 4.5 mm

**917-04-06**  
28 cm / 11"  
Ø 6 mm

**917-05-08**  
28 cm / 11"  
Ø 8 mm

**917-06-10**  
28 cm / 11"  
Ø 10 mm

**917-07-12**  
28 cm / 11"  
Ø 12 mm

**917-08-14**  
28 cm / 11"  
Ø 14 mm

**917-09-10**  
10 cm / 4"

**Uteruslöffel  
Uterine Scoops  
Curettes Utérines**



¼  
Fig. 1  
918-01-07  
918-07-07  
7 mm

¼  
Fig. 2  
918-02-08  
918-08-08  
8 mm

¼  
Fig. 3  
918-03-10  
918-09-10  
10 mm

¼  
Fig. 4  
918-04-11  
918-10-11  
11 mm

¼  
Fig. 5  
918-05-12  
918-11-12  
12 mm

¼  
Fig. 6  
918-06-15  
918-12-15  
15 mm

¼  
Fig. 1  
918-13-05  
5 mm

¼  
Fig. 2  
918-14-08  
8 mm

¼  
Fig. 3  
918-15-10  
10 mm

¼  
Fig. 4  
918-16-12  
12 mm

¼  
Fig. 5  
918-17-15  
15 mm

¼  
Fig. 6  
918-18-17  
17 mm

¼  
Fig. 7  
918-19-20  
20 mm

Simon  
918-01-07 To 918-06-15  
25 cm / 10"  
Sharp

Simon  
918-07-07 To 918-12-15  
29 cm / 11½"  
Sharp

918-13-05 To 918-19-20  
29 cm / 11½"  
Sharp

**Uteruslöffel  
Uterine Scoops  
Curettes Utérines**



$\frac{1}{4}$   
Fig. 1  
919-01-07  
919-07-07  
7 mm

$\frac{1}{4}$   
Fig. 2  
919-02-08  
919-08-08  
8 mm

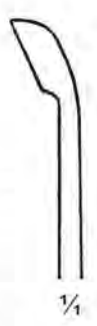

$\frac{1}{4}$   
Fig. 3  
919-03-10  
919-09-10  
10 mm

$\frac{1}{4}$   
Fig. 4  
919-04-11  
919-10-11  
11 mm



$\frac{1}{4}$        $\frac{1}{4}$        $\frac{1}{4}$   
919-13-06    919-14-08    919-15-10  
6 mm          8 mm          10 mm

$\frac{1}{4}$   
Fig. 5  
919-05-12  
919-11-12  
12 mm

$\frac{1}{4}$   
Fig. 6  
919-06-15  
919-12-15  
15 mm

$\frac{1}{4}$   
919-16-12  
12 mm

$\frac{1}{4}$   
919-17-14  
14 mm



$\frac{1}{2}$   
Schroeder  
919-01-07 To 919-06-15  
30 cm / 12"  
Sharp

$\frac{1}{2}$   
Schroeder  
919-07-07 To 919-12-15  
30 cm / 12"  
Sharp

$\frac{1}{2}$   
Gourdet  
919-13-06 To 919-17-14  
28 cm / 11"  
Blunt



Vaginalspekula  
Vaginal Specula  
Spéculum vaginaux



Grave  
920-01-75  
75 X 20 mm



Grave  
920-02-95  
95 X 30 mm

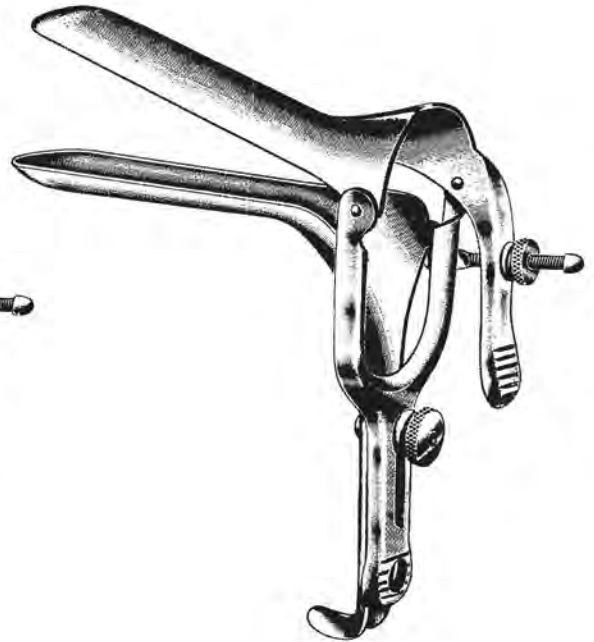

Grave  
920-03-115  
115 X 35 mm



Grave Modif.  
920-04-45  
115 X 35 mm  
45°



Grave Modif.  
920-05-90  
115 X 35 mm  
90°



1/2  
Pederson  
920-06-75 75 X 13 mm  
920-07-100 100 X 22 mm  
920-08-120 120 X 25 mm

Vaginalspekula  
Vaginal Specula  
Spéculum vaginaux



Grave  
921-01-01 75 X 20 mm  
921-02-02 95 X 30 mm  
921-03-03 115 X 35 mm  
Suction tube on upper blade

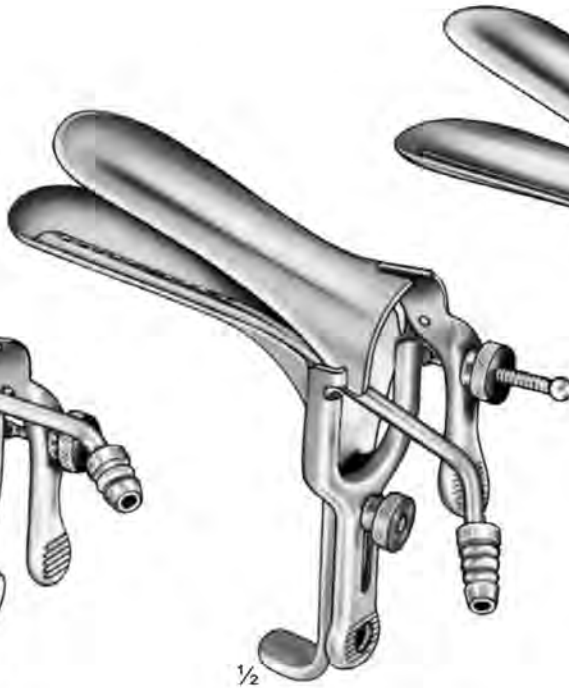

Grave  
921-04-01 75 X 20 mm  
921-05-02 95 X 30 mm  
921-06-03 115 X 35 mm  
Suction tube on lower blade

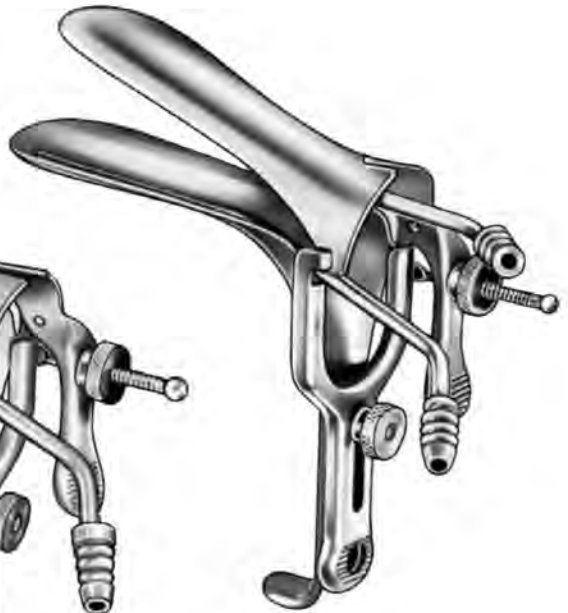

Grave  
921-07-01 75 X 20 mm  
921-08-02 95 X 30 mm  
921-09-03 115 X 35 mm  
Suction tube on upper and lower blades

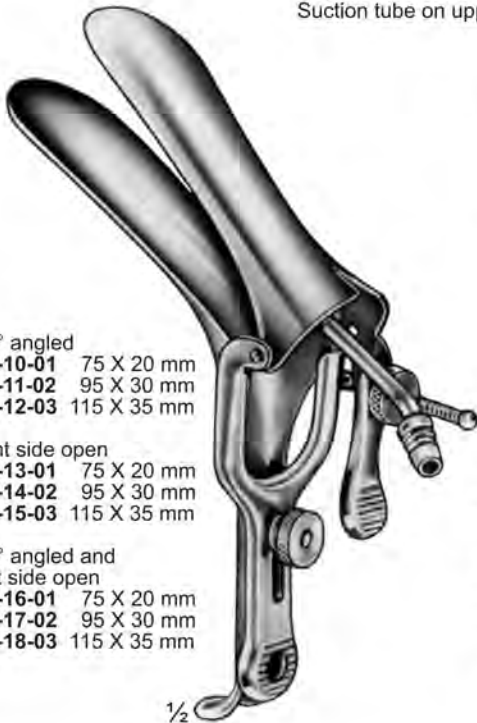

135° angled  
921-10-01 75 X 20 mm  
921-11-02 95 X 30 mm  
921-12-03 115 X 35 mm

Right side open  
921-13-01 75 X 20 mm  
921-14-02 95 X 30 mm  
921-15-03 115 X 35 mm

135° angled and right side open  
921-16-01 75 X 20 mm  
921-17-02 95 X 30 mm  
921-18-03 115 X 35 mm

Grave Special  
921-10-01 To 921-18-03  
Suction tube on upper blade

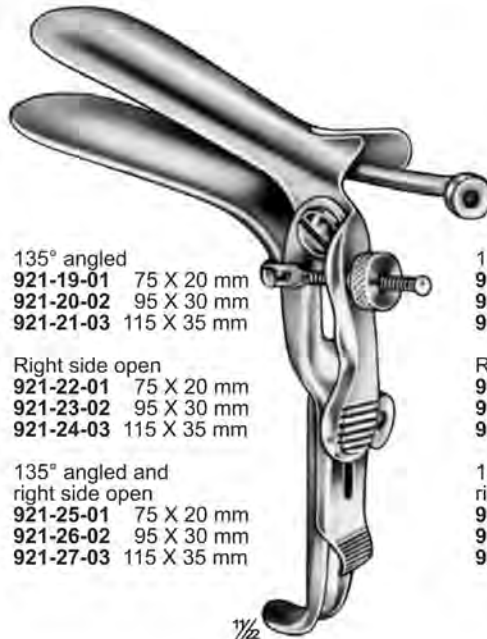

135° angled  
921-19-01 75 X 20 mm  
921-20-02 95 X 30 mm  
921-21-03 115 X 35 mm

Right side open  
921-22-01 75 X 20 mm  
921-23-02 95 X 30 mm  
921-24-03 115 X 35 mm

135° angled and right side open  
921-25-01 75 X 20 mm  
921-26-02 95 X 30 mm  
921-27-03 115 X 35 mm

Grave Special  
921-19-01 To 921-27-03  
Suction tube on upper blade

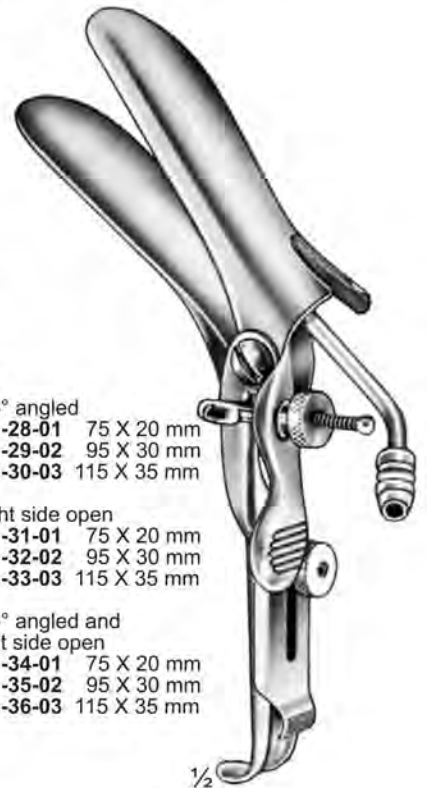

135° angled  
921-28-01 75 X 20 mm  
921-29-02 95 X 30 mm  
921-30-03 115 X 35 mm

Right side open  
921-31-01 75 X 20 mm  
921-32-02 95 X 30 mm  
921-33-03 115 X 35 mm

135° angled and right side open  
921-34-01 75 X 20 mm  
921-35-02 95 X 30 mm  
921-36-03 115 X 35 mm

Grave Special  
921-28-01 To 921-36-03  
Suction tube on upper and lower blades

Vaginalspekula  
Vaginal Specula  
Spéculum vaginaux



1/2

Cusco  
922-01-00  
75 X 17 mm  
Virgin



1/2

Cusco  
922-02-01 75 X 32 mm  
922-03-02 85 X 35 mm  
922-04-03 100 X 35 mm



1/2

Cusco  
922-05-01 80 X 22 mm  
922-06-02 100 X 25 mm  
922-07-03 105 X 27 mm  
Swiss model

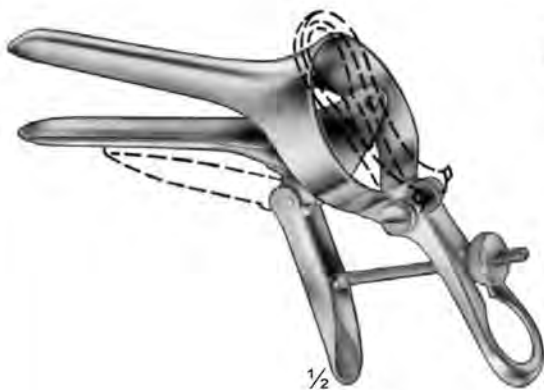

1/2

Cusco  
922-08-00  
75 X 17 mm  
Virgin



1/2

Cusco  
922-09-01 75 X 32 mm  
922-10-02 85 X 35 mm  
922-11-03 100 X 35 mm



1/2

Cusco  
922-12-01 80 X 22 mm  
922-13-02 90 X 37 mm  
922-14-03 115 X 37 mm  
Flat duck beak

Vaginalspekula  
Vaginal Specula  
Spéculum vaginaux

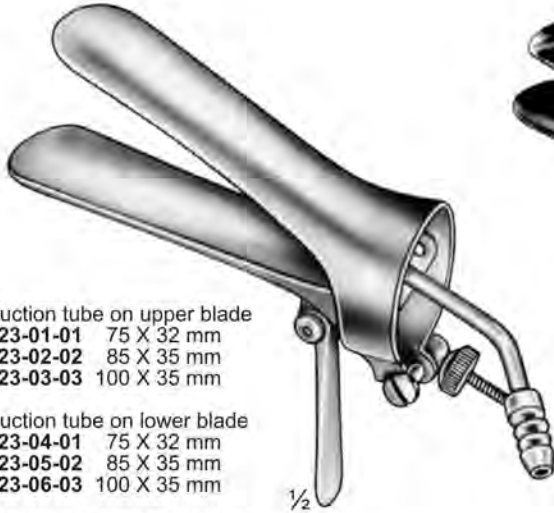

Suction tube on upper blade  
923-01-01 75 X 32 mm  
923-02-02 85 X 35 mm  
923-03-03 100 X 35 mm

Suction tube on lower blade  
923-04-01 75 X 32 mm  
923-05-02 85 X 35 mm  
923-06-03 100 X 35 mm

Suction tube on both blade  
923-07-01 75 X 32 mm  
923-08-02 85 X 35 mm  
923-09-03 100 X 35 mm

Cusco  
923-01-01 To 923-09-03



Cusco  
923-10-01 75 X 32 mm  
923-11-02 85 X 35 mm  
923-12-03 100 X 35 mm  
Cromium plated in  
black colour



Cusco  
923-13-01 80 X 22 mm  
923-14-02 100 X 25 mm  
923-15-03 105 X 27 mm  
Cromium plated in  
black colour



Cusco (Japanese Model)  
923-16-01 Small  
923-17-02 Medium  
923-18-03 Large



Collin  
923-19-00  
55 X 10 mm  
For children

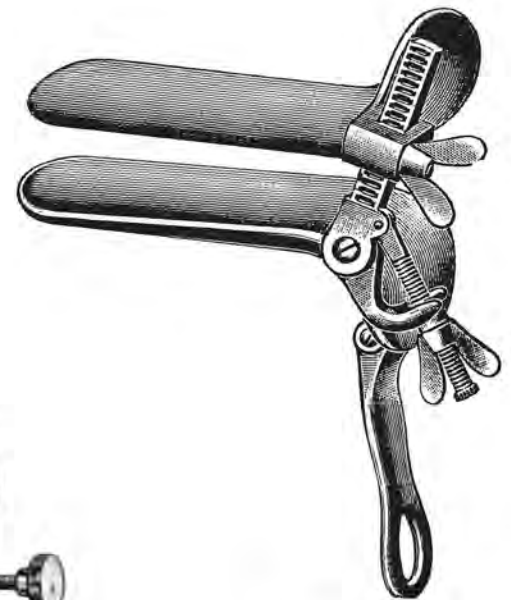

Trelat  
923-20-01 85 X 33 mm  
923-21-02 95 X 35 mm  
923-23-03 115 X 43 mm

Vaginalspekula  
Vaginal Specula  
Spéculum vaginaux



Collin  
924-01-00  
65 X 20 mm  
Virgin



Collin  
924-02-01 85 X 30 mm Small  
924-03-02 100 X 35 mm Medium  
924-04-03 110 X 40 mm Large



Collin (New Model)  
924-03-02  
100 X 35 mm  
Medium



Collin (New Model)  
924-04-03  
110 X 40 mm  
Large



Collin (New Model)  
924-05-00 65 X 20 mm Virgin  
924-06-01 85 X 30 mm Small  
924-07-02 100 X 35 mm Medium  
924-08-03 110 X 40 mm Large  
Cromium plated in  
black colour

Vaginalspekula  
Vaginal Specula  
Spéculum vaginaux

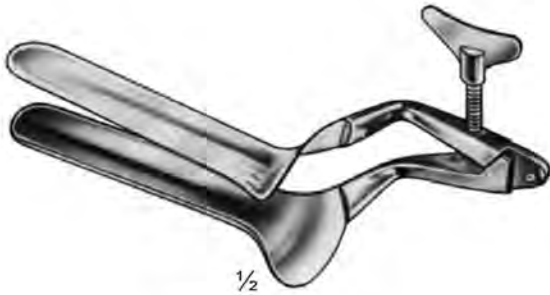

Collin  
925-01-01 65 X 20 mm  
925-02-02 90 X 16 mm

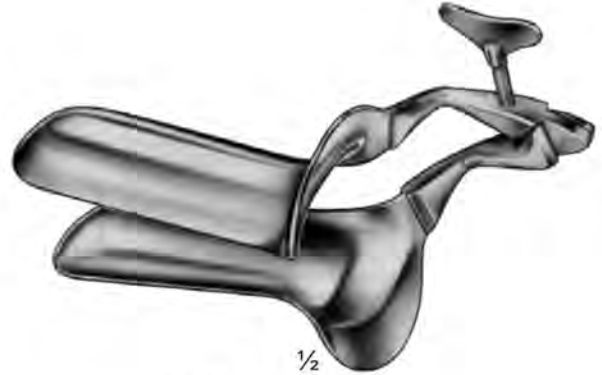

Collin  
925-03-01 85 X 30 mm  
925-04-02 100 X 35 mm  
925-05-03 110 X 40 mm



Collin-Landau  
925-06-01 90 X 30 mm  
925-07-02 100 X 35 mm



Seyffert  
925-08-100 100 X 17 mm  
925-09-110 110 X 33 mm  
23 cm / 9"



Seyffert  
925-10-110 110 X 33 mm  
23 cm / 9"  
One side open for taking  
instruments and catheters

Vaginalspekula  
Vaginal Specula  
Spéculums vaginaux



Semm  
926-01-01 90 X 14 mm  
926-02-02 100 X 17 mm  
926-03-03 100 X 25 mm

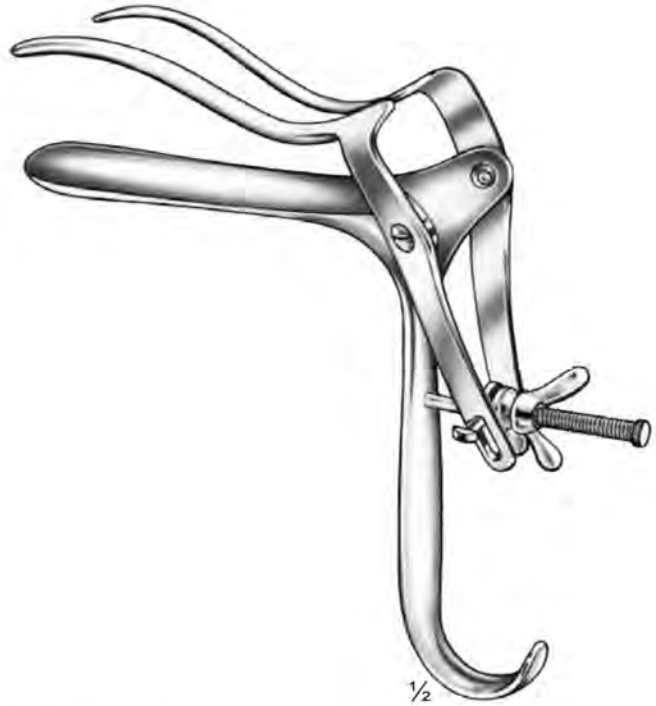

Nott  
926-04-01 80 X 30 mm  
926-05-02 110 X 30 mm



Guttmann  
926-06-90  
90 X 35 mm



Guttmann  
926-07-80  
80 X 45 mm



Fergusson  
926-08-25 Ø 25 mm  
926-09-30 Ø 30 mm  
926-10-35 Ø 35 mm

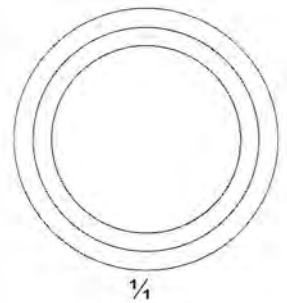

Vaginalspekula  
Vaginal Specula  
Spéculums vaginaux



Auvar  
927-01-75 75 X 42 mm  
927-02-105 105 X 43 mm  
23 cm / 9"  
1.470 kg  
With detachable weight



Auvar  
927-03-65 65 X 38 mm  
23 cm / 9"  
1.530 kg  
With fixed weight



Auvar  
927-04-80 80 X 38 mm  
21 cm / 8 1/4"  
With detachable weight

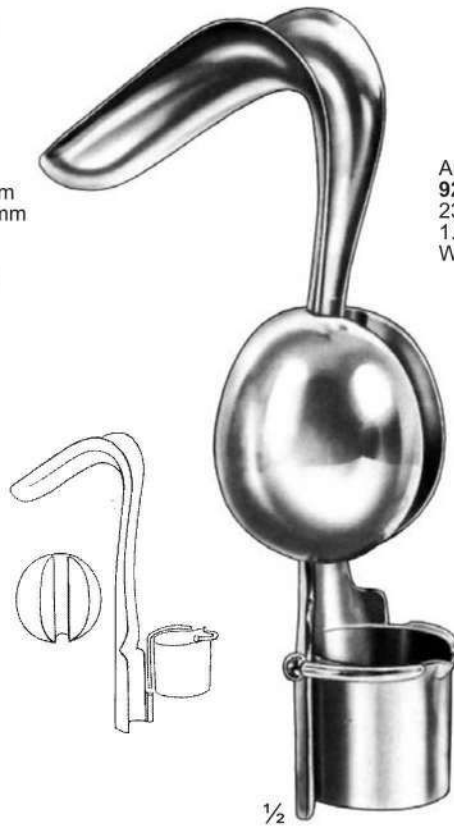

Samuel  
927-05-85 85 X 36 mm  
21 cm / 8 1/4"  
With detachable weight and  
metal strainer with perforated bottom



Vaginalspekula  
Vaginal Specula  
Spéculum vaginaux



1/2

Weissbarth  
928-01-80 80 X 28 mm  
928-02-85 85 X 42 mm  
21 cm / 8 1/4"

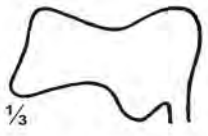

1/3

928-03-35  
35 X 54 mm

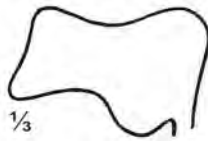

1/3

928-04-39  
39 X 60 mm

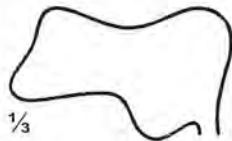

1/3

928-05-42  
42 X 65 mm

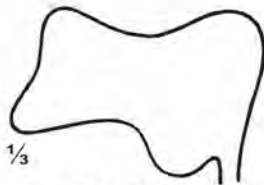

1/3

928-06-48  
48 X 68 mm



1/2

928-03-35 To 928-06-48  
27 cm / 10 1/2"



1/2

Soonawala  
928-07-01



1/2

Soonawala  
928-08-02

Vaginalspekula  
Vaginal Specula  
Spéculums vaginaux



929-01-80  
80 X 30 mm



929-02-85  
85 X 35 mm



929-03-85  
85 X 40 mm

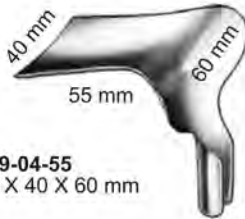

929-04-55  
55 X 40 X 60 mm



929-05-70  
70 X 45 X 70 mm



Scherback  
929-06-19  
19 cm / 7½"  
929-07-05  
Complete with 5 blades  
(929-01-80 To 929-05-80)



1/2  
Scherback  
929-08-19  
19 cm / 7½"  
929-09-05  
Complete with 5 blades  
(929-01-80 To 929-05-70)



1/2  
Scherback  
929-10-18  
18 cm / 7"  
929-11-05  
Complete with 5 blades  
(929-01-80 To 929-05-70)



Scherback  
929-12-800  
800 grs



1/2  
Scherback  
929-13-400 400 grs  
929-14-800 800 grs

Vaginalspekula  
 Vaginal Specula  
 Spéculum vaginaux



930-01-80  
 80 X 30 mm



930-02-85  
 85 X 33 mm



930-03-100  
 100 X 38 mm



930-04-110  
 110 X 42 mm



930-05-65  
 65 X 30 mm



930-06-75  
 75 X 35 mm



930-07-85  
 85 X 35 mm



930-08-95  
 95 X 35 mm



Bozemann  
 930-09-23  
 23 cm / 9"  
 930-10-08  
 Complete with 8 blades  
 (930-01-80 To 930-08-95)



Bozemann  
 930-11-22  
 22 cm / 8¾"  
 930-12-08  
 Complete with 8 blades  
 (930-01-80 To 930-08-95)



Bozemann  
 930-13-23  
 23 cm / 9"  
 930-14-08  
 Complete with 8 blades  
 (930-01-80 To 930-08-95)



Bozemann  
 930-15-22  
 22 cm / 8¾"  
 930-16-08  
 Complete with 8 blades  
 (930-01 To 930-08)

Vaginalspekula  
Vaginal Specula  
Spéculum vaginaux



Sims  
**931-01-01** 65 X 25 mm  
 70 X 20 mm  
**931-02-02** 70 X 30 mm  
 70 X 35 mm  
**931-03-03** 85 X 35 mm  
 90 X 40 mm



**931-09-76**  
76 X 38 mm



**931-10-89**  
89 X 38 mm



**931-11-102**  
102 X 38 mm



Eastman  
**931-04-01** 75 X 38 mm  
**931-05-02** 90 X 38 mm  
**931-06-03** 100 X 38 mm



Breisky  
**931-07-01** 72 X 25 mm  
 77 X 30 mm  
**931-08-02** 75 X 30 mm  
 92 X 38 mm



Jackson  
**931-09-89 To 931-11-102**  
18 cm / 7"

Vaginalspekula  
Vaginal Specula  
Spéculum vaginaux





Vaginalspekula  
Vaginal Specula  
Spéculums vaginaux

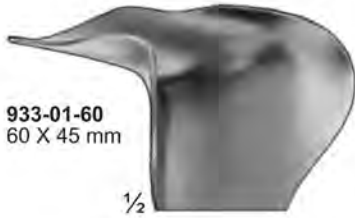

933-01-60  
60 X 45 mm

1/2

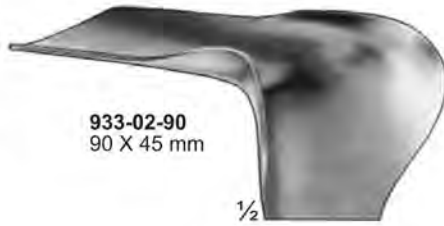

933-02-90  
90 X 45 mm

1/2



933-03-112  
112 X 45 mm

1/2



1/2

Doyen  
933-01-60 To 933-03-112  
23.5 cm / 9 1/4"



1/2

- 933-04-60 60 X 35 mm
- 933-05-90 90 X 35 mm
- 933-06-120 120 X 35 mm
- 933-07-60 60 X 45 mm
- 933-08-90 90 X 45 mm
- 933-09-120 120 X 45 mm
- 933-10-160 160 X 45 mm
- 933-11-60 60 X 60 mm
- 933-12-90 90 X 60 mm
- 933-13-120 120 X 60 mm
- 933-14-160 160 X 60 mm

Doyen  
933-04-60 To 933-14-160  
24 cm / 9 1/2"



60 X 30 mm

1/2

Doyen  
933-15-23  
23 cm / 9"  
Lateral speculum



80 X 30 mm

1/2

Doyen  
933-16-25  
25 cm / 10"  
Lateral speculum

Vaginalspekula  
Vaginal Specula  
Spéculum vaginaux

- 934-01-100 100 X 20 mm
- 934-02-100 100 X 25 mm
- 934-03-100 100 X 30 mm
- 934-04-100 100 X 35 mm
- 934-05-130 130 X 40 mm  
30 cm / 12"
- 934-06-130 130 X 20 mm
- 934-07-130 130 X 25 mm
- 934-08-130 130 X 30 mm
- 934-09-130 130 X 35 mm
- 934-10-130 130 X 40 mm  
32 cm / 12<sup>3</sup>/<sub>4</sub>"
- 934-11-160 160 X 40 mm
- 934-12-180 180 X 40 mm  
35 cm / 14"



1/2  
Breisky  
(Wiener Model/Vienna Pattern)  
934-01-100 To 934-12-180  
32 cm / 12<sup>3</sup>/<sub>4</sub>"



1/2  
Landau  
934-13-100 100 X 28 mm  
934-14-110 110 X 28 mm  
29 cm / 11<sup>1</sup>/<sub>2</sub>"



- 934-16-90 90 X 20 mm
- 934-17-100 100 X 10 mm
- 934-18-100 100 X 15 mm
- 934-19-100 100 X 20 mm
- 934-20-100 100 X 25 mm  
27 cm / 10<sup>1</sup>/<sub>2</sub>"

- 934-21-130 130 X 20 mm
- 934-22-130 130 X 25 mm
- 934-23-130 130 X 30 mm
- 934-24-130 130 X 35 mm
- 934-25-130 130 X 40 mm  
31 cm / 12<sup>1</sup>/<sub>4</sub>"

Matzenauer  
934-16-90 To 934-25-130

1/2  
Dunkel  
934-15-25  
25 cm / 10"

Vaginalspekula  
Vaginal Specula  
Spéculum vaginaux



935-01-70  
18 cm / 7"  
70 X 15 mm



935-05-75  
18 cm / 7"  
75 X 10 mm

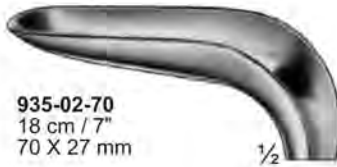

935-02-70  
18 cm / 7"  
70 X 27 mm



935-06-75  
18 cm / 7"  
75 X 23 mm

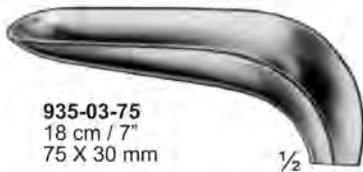

935-03-75  
18 cm / 7"  
75 X 30 mm



935-07-80  
18 cm / 7"  
80 X 25 mm

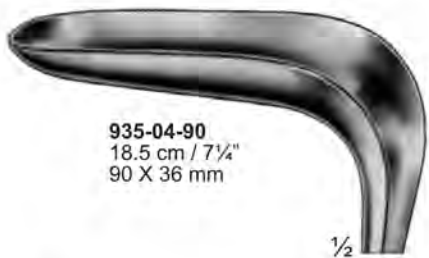

935-04-90  
18.5 cm / 7 1/4"  
90 X 36 mm



935-08-100  
18.5 cm / 7 1/4"  
100 X 32 mm



Kristeller  
935-01-70 To 935-04-90  
Speculum



Kristeller  
935-05-75 To 935-08-100  
Retractor



Kristeller  
935-09-02 To 935-12-02  
Set of 2 pcs consisting  
1 Speculum and 1 Retractor

935-09-02 (935-01-70 TO 935-05-75)  
935-10-02 (935-02-70 TO 935-06-75)  
935-11-02 (935-03-90 TO 935-07-80)  
935-12-02 (935-04-90 TO 935-08-100)



Vaginalspekula  
Vaginal Specula  
Spéculum vaginaux



**936-01-110**  
21.5 cm / 8½"  
110 X 18 mm

½

**936-02-110**  
21.5 cm / 8½"  
110 X 27 mm

½

½

Kristeller  
**936-01-110 & 936-02-115**  
Speculum



**936-03-115**  
21.5 cm / 8½"  
115 X 14 mm

½

**936-04-115**  
21.5 cm / 8½"  
115 X 23 mm

½

½

Kristeller  
**936-03-115 & 936-04-115**  
Retractor

**936-05-02** (936-01-110 & 936-03-115)  
**936-06-02** (936-02-110 & 936-04-115)



½

Kristeller  
**936-05-2 TO 936-06-02**  
Set of 2 pcs consisting  
1 Speculum and 1 Retractor

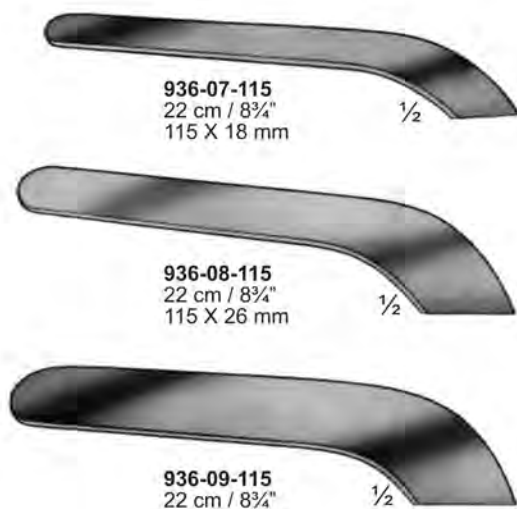

**936-07-115**  
22 cm / 8¾"  
115 X 18 mm

½

**936-08-115**  
22 cm / 8¾"  
115 X 26 mm

½

**936-09-115**  
22 cm / 8¾"  
115 X 32 mm

½

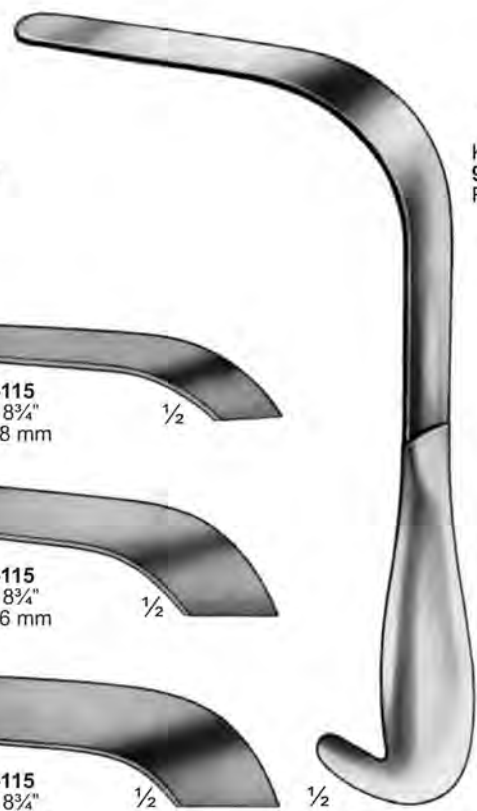

½

**936-07-115 To 936-09-115**  
Retractor



# Vaginalspekula Vaginal Specula Spéculum vaginaux



937-01-110  
21.5 cm / 8½"  
110 X 27 mm

½



937-04-115  
21.5 cm / 8½"  
115 X 23 mm

½



937-02-110  
22 cm / 8¾"  
110 X 30 mm

½



937-05-115  
22 cm / 8¾"  
115 X 28 mm

½



937-03-110  
23 cm / 9"  
110 X 36 mm

½



937-06-120  
23 cm / 9"  
120 X 30 mm

½



½

Kristeller  
937-01-110 To 937-03-110  
Speculum



½

Kristeller  
937-04-115 To 937-06-120  
Retractor



½

Kristeller  
937-07-02 To 937-09-02  
Set of 2 pcs consisting  
1 Speculum and 1 Retractor

937-07-02 (937-01-110 & 936-04-115)  
937-08-02 (936-02-110 & 936-05-115)  
937-09-02 (936-03-110 & 936-06-120)

Vaginalspekula  
Vaginal Specula  
Spéculum vaginaux



1/2  
938-01-01 105 X 26 mm  
938-02-02 105 X 28 mm  
938-03-03 105 X 33 mm  
Specula



1/2  
Kristeller  
938-04-01 115 X 22 mm  
938-05-02 115 X 24 mm  
938-06-03 115 X 29 mm  
Retractors



938-07-02 (938-01-01 TO 938-04-01)  
938-08-02 (938-02-02 TO 938-05-02)  
938-09-02 (938-03-03 TO 938-06-03)

1/2  
Kristeller  
938-07-02 To 938-09-02  
Set of 2 pcs consisting  
1 Speculum and 1 Retractor

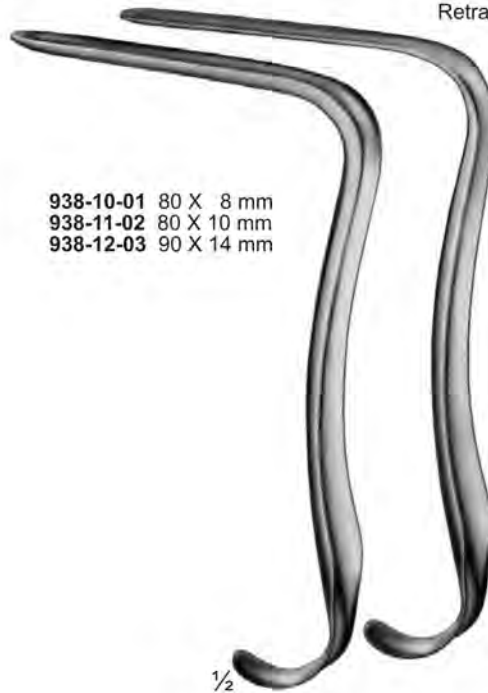

938-10-01 80 X 8 mm  
938-11-02 80 X 10 mm  
938-12-03 90 X 14 mm

1/2  
Seidl  
938-10-01 To 938-12-03  
For children and infants

Vaginalspekula  
Vaginal Specula  
Spéculums vaginaux



1/2  
Kristeller (Wiener Model)  
939-01-01 110 X 20 mm  
939-02-02 110 X 27 mm  
939-03-03 110 X 30 mm  
939-04-04 110 X 36 mm

Kristeller (Weiner Model)  
939-05-01 110 X 20 mm  
939-06-02 110 X 27 mm  
939-07-03 110 X 30 mm  
939-08-04 110 X 36 mm

1/2  
939-09-140  
140 X 30 mm  
Extra large pattern  
Retractor

1/2  
939-10-135  
135 X 36 mm  
Extra large pattern  
Speculum

1/2  
939-11-2  
Set of 2 pcs consisting  
1 Speculum 939-09-140  
1 Retractor 939-10-135



Vaginalspekula  
Vaginal Specula  
Spéculums vaginaux



Landon  
**940-01-88**  
22 cm / 8 $\frac{3}{4}$ "  
88 X 25 mm



$\frac{1}{2}$   
**940-02-01** 100 X 11 mm  
100 X 20 mm  
**940-03-02** 100 X 14 mm  
100 X 26 mm



Kallmorgen  
**940-04-75**  
17 cm / 6 $\frac{3}{4}$ "  
75 X 39 mm

Kallmorgen  
**940-05-75**  
17 cm / 6 $\frac{3}{4}$ "  
75 X 33 mm  
**940-06-02** Set of 2 pcs  
(940-04-75 TO 940-05-75)



Kallmorgen  
**940-07-95**  
20 cm / 8"  
95 X 39 mm

Kallmorgen  
**940-08-95**  
20 cm / 8"  
95 X 33 mm  
**940-09-2** Set of 2 pcs  
(940-07-95 TO 940-08-95)

Vaginalspekula  
Vaginal Specula  
Spéculums vaginaux

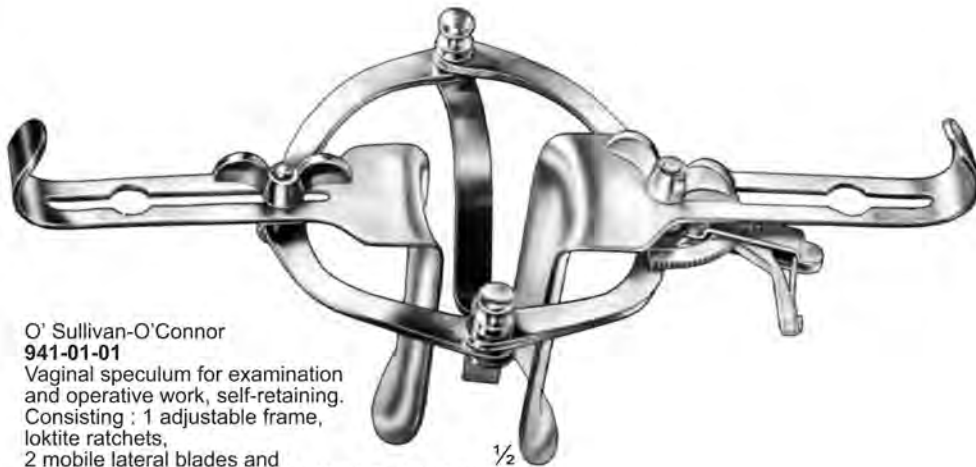

O' Sullivan-O'Connor  
**941-01-01**  
Vaginal speculum for examination and operative work, self-retaining. Consisting : 1 adjustable frame, loktite ratchets, 2 mobile lateral blades and 3 interchangeable blades 941-02-45 To 941-04-90



**941-02-45**  
45 X 17 mm

**941-03-90**  
90 X 37 mm

**941-04-90**  
90 X 45 mm



**941-05-25**  
25 cm / 10"

**Tubinger Model 941-06-26**  
26.5 cm / 10½"



**941-07-115**  
115 X 22 mm

**941-08-115**  
115 X 26 mm

**Simon 941-07-115 TO 941-08-115**  
27.5 cm / 10¾"

Vaginalspekula  
Vaginal Specula  
Spéculum vaginaux

942-05-60 60 X 32 mm  
942-06-85 85 X 32 mm



942-01-45 45 X 25 mm  
942-02-65 65 X 28 mm  
942-03-82 82 X 28 mm

1/2  
Heaney  
942-01-45 To 942-03-82  
19 cm / 7 1/2"



85 X 32 mm

1/2  
Olshausen  
942-04-21  
21 cm / 8 1/4"



1/2  
Doyen  
942-05-60 TO 942-06-85  
24 cm / 9 1/2"



1/2  
Gelpi  
942-07-13 13.5 cm / 5 1/4"  
942-08-18 18 cm / 7"



1/2  
Richter  
942-09-17  
17 cm / 6 3/4"



1/2  
942-10-17  
17 cm / 6 3/4"



1/2  
Joll (Friedman)  
942-11-15  
15 cm / 6"

Vaginalspekula  
Vaginal Specula  
Spéculum vaginaux

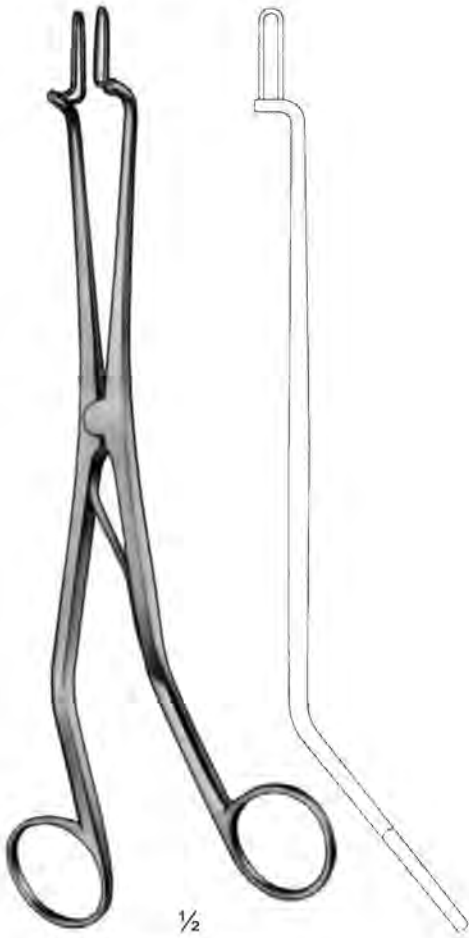
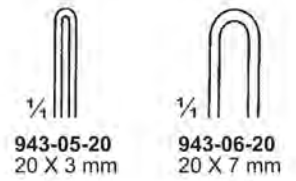
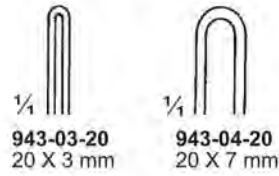
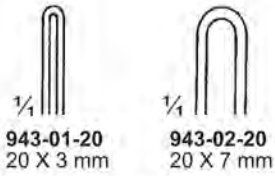

Kogan  
943-01-20 TO 943-02-20  
24 cm / 9 1/2"  
Endospecula for cervix  
and urethra, without ratchet



Kogan  
943-03-20 TO 943-04-20  
24 cm / 9 1/2"  
Endospecula for cervix  
and urethra, with scale-ratchet  
and fixing screws



Kogan  
943-05-20 TO 943-06-20  
28 cm / 11"  
Endospecula for cervix  
and urethra, with ratchet



**Abortuszangen  
Placenta and Ovum Forceps  
Pincés placentaires et pour poste-abortum**

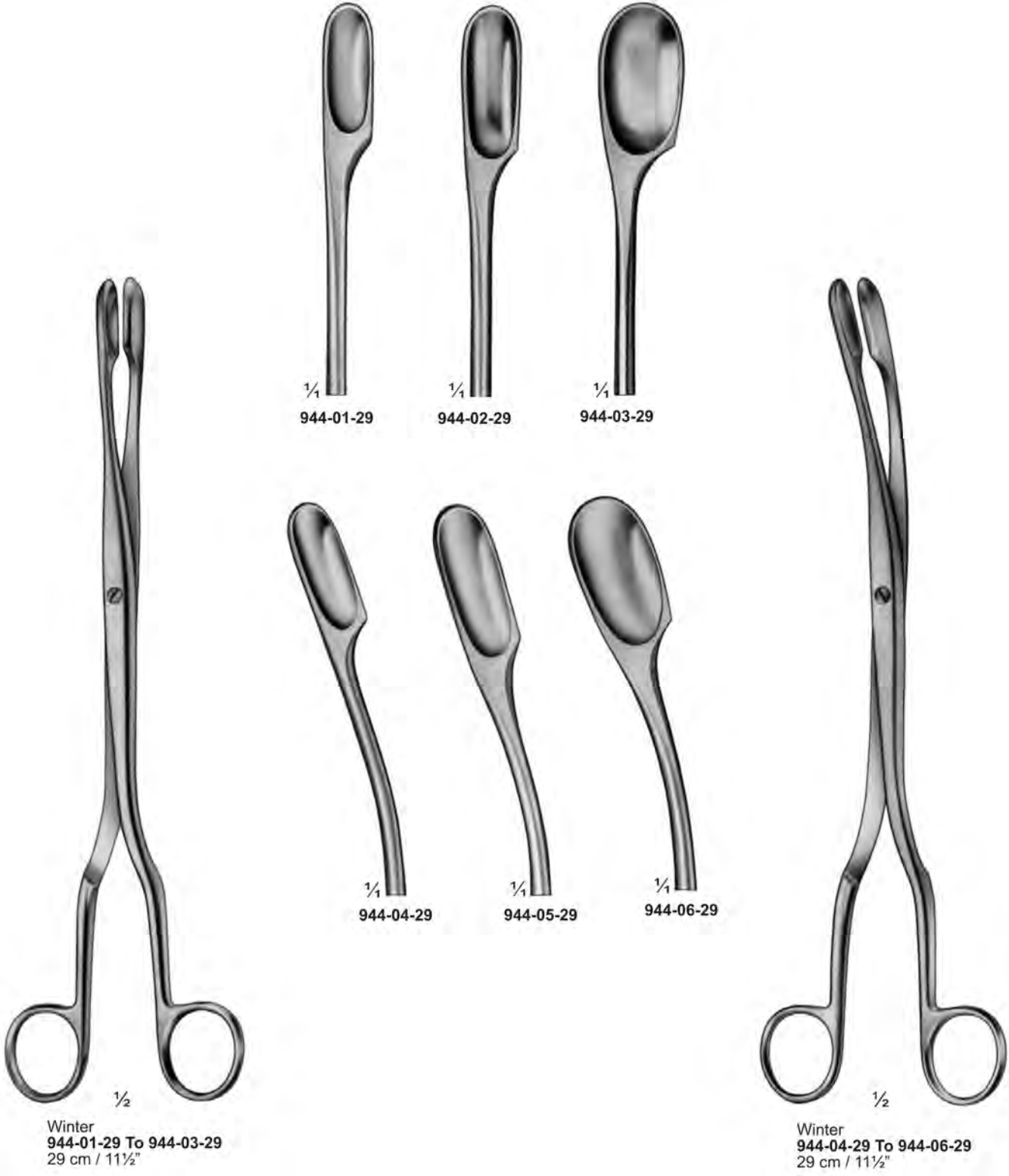

**Abortuszangen  
Placenta and Ovum Forceps  
Pincés placentaires et pour poste-abortum**



Winter  
945-01-29 To 945-03-29  
29 cm / 11½"

Winter  
945-04-29 To 945-06-29  
29 cm / 11½"

**Abortuszangen**  
**Placenta and Ovum Forceps**  
**Pinces placentaires et pour poste-abortum**

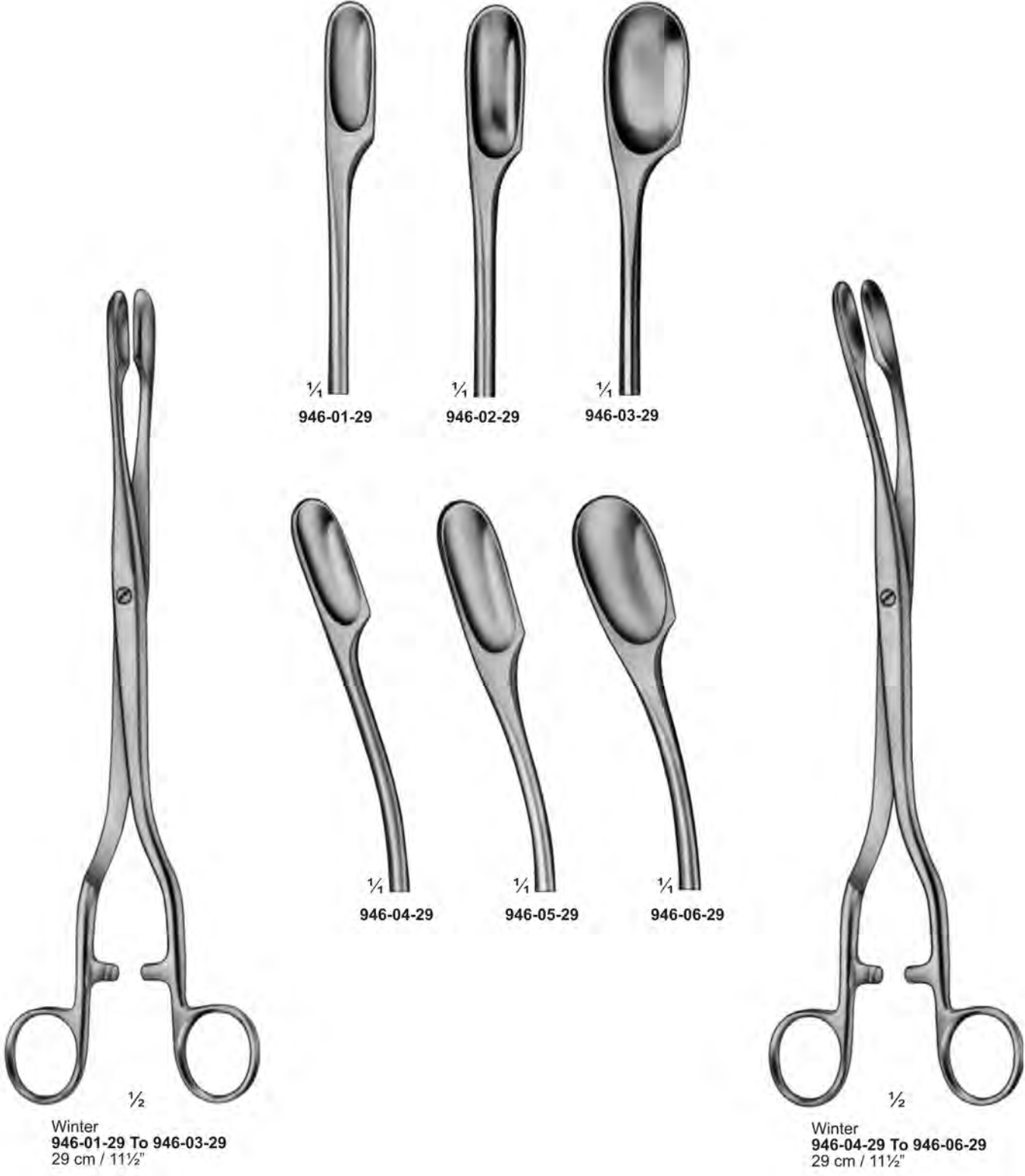

$\frac{1}{4}$   
**946-01-29**

$\frac{1}{4}$   
**946-02-29**

$\frac{1}{4}$   
**946-03-29**

$\frac{1}{4}$   
**946-04-29**

$\frac{1}{4}$   
**946-05-29**

$\frac{1}{4}$   
**946-06-29**

$\frac{1}{2}$   
**Winter**  
**946-01-29 To 946-03-29**  
**29 cm / 11½"**

$\frac{1}{2}$   
**Winter**  
**946-04-29 To 946-06-29**  
**29 cm / 11½"**

**Abortuszangen  
Placenta and Ovum Forceps  
Pincés placentaires et pour poste-abortum**



**Abortuszangen  
Placenta and Ovum Forceps  
Pincers placentaires et pour poste-abortum**

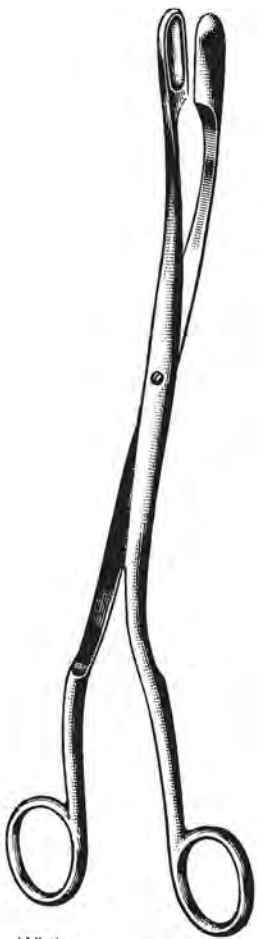

Winter  
948-01-27 To 948-03-27  
27 cm / 10½"

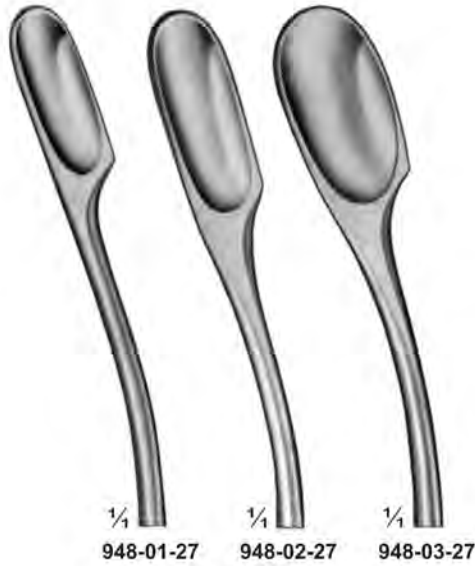

¼ 948-01-27    ¼ 948-02-27    ¼ 948-03-27



¼



½  
Mc Clintock  
948-04-24  
24 cm / 9½"

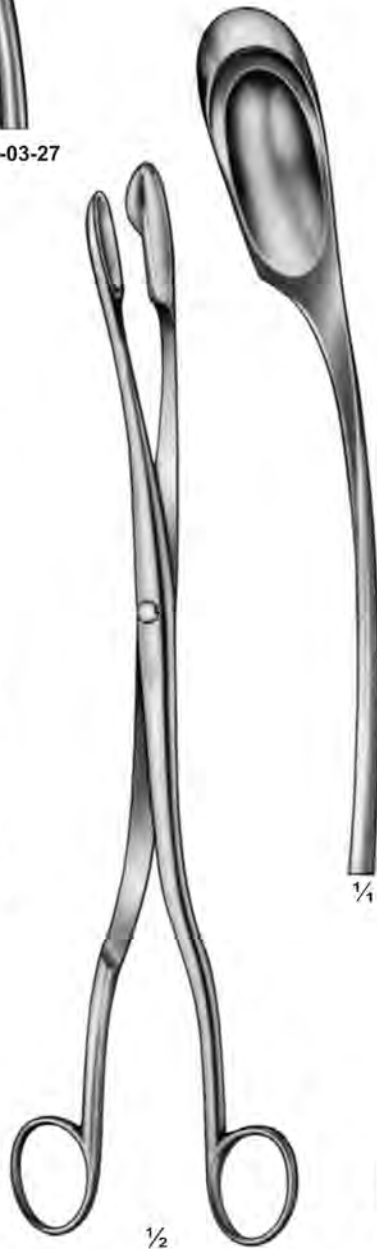

½  
948-05-28  
28.5 cm / 11¼"

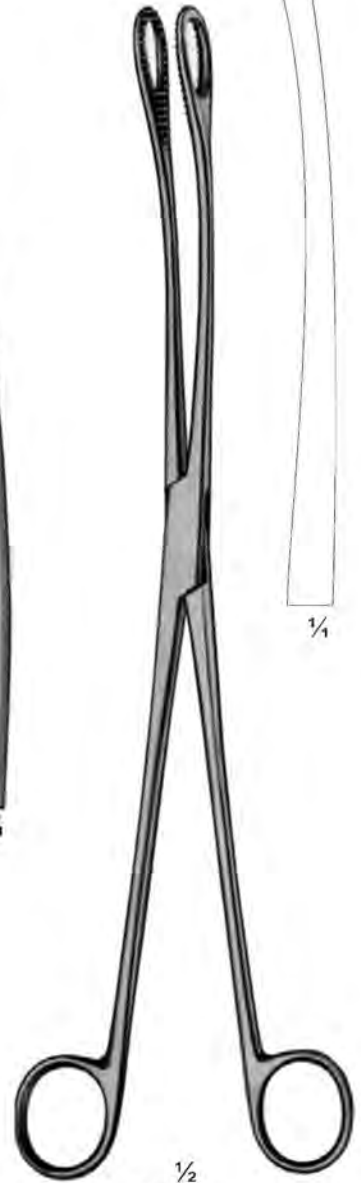

½  
Kelly  
948-06-32  
32 cm / 12¾"

**Abortuszangen  
Placenta and Ovum Forceps  
Pincers placentaires et pour poste-abortum**

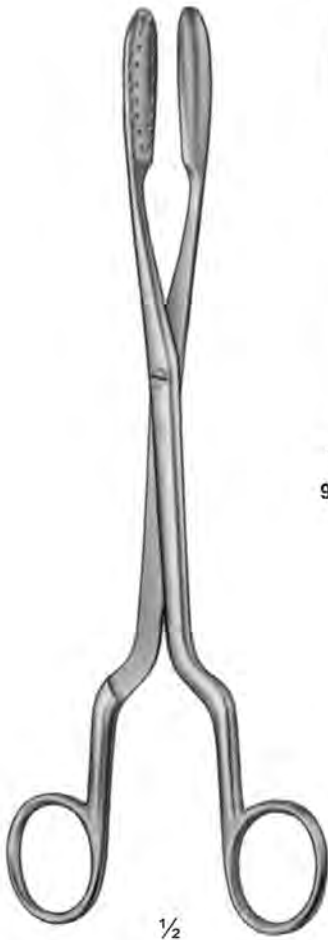

$\frac{1}{2}$   
Lewkowitz  
949-01-24 TO 949-02-24  
24.5 cm / 9 $\frac{3}{4}$ "



$\frac{1}{4}$   
949-01-24



$\frac{1}{4}$   
949-02-24

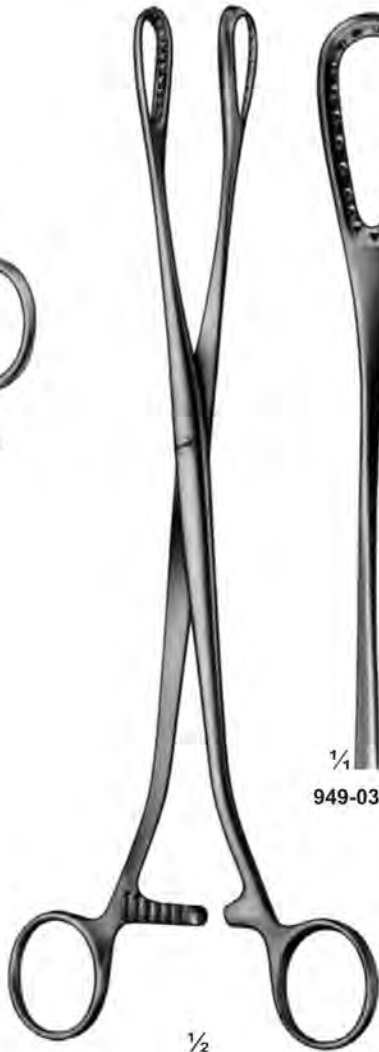

$\frac{1}{2}$   
Saenger  
949-03-27 TO 949-04-27  
27.5 cm / 10 $\frac{3}{4}$ "



$\frac{1}{4}$   
949-03-27



$\frac{1}{4}$   
949-04-27



$\frac{1}{2}$   
Saenger  
949-05-28  
28.5 cm / 11 $\frac{1}{4}$ "

$\frac{1}{4}$

Abortuszangen  
Placenta and Ovum Forceps  
Pincers placentaires et pour poste-abortum



Kranz  
950-01-29 & 950-02-29  
29 cm / 11½"  
Fanestrated jaws



950-01-29



950-02-29



1/4



1/4

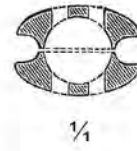

1/4

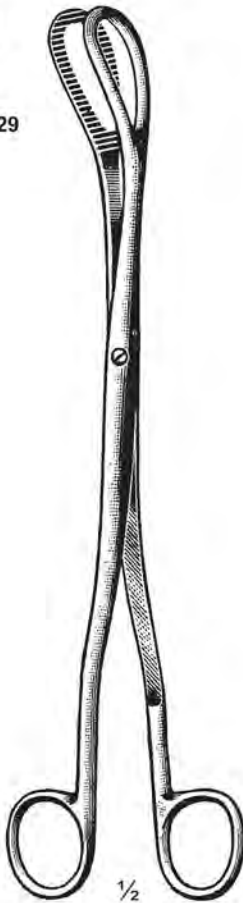

Corey  
950-03-24  
24 cm / 9½"



Naegele  
950-04-26  
26 cm / 10¼"



Smellie  
950-05-27  
27 cm / 10½"



Smellie  
950-06-25 25 cm / 10"  
950-07-27 27 cm / 10½"

Geburts Instrumente  
 Obstetric Instruments  
 Instruments Obstetricaux

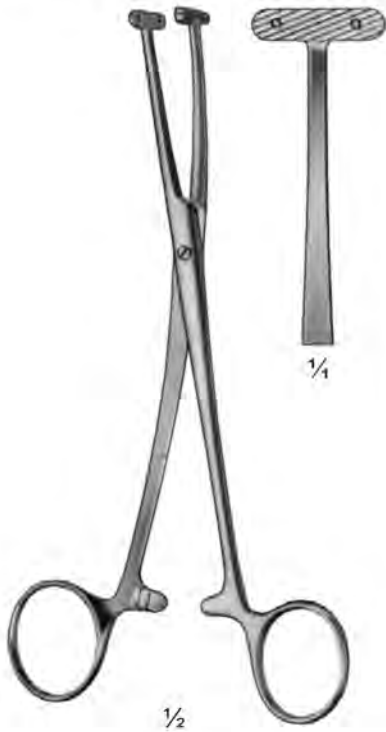

Willet  
 951-01-18  
 18.5 cm / 7 1/4"



Gauss  
 951-03-26  
 26 cm / 10 1/4"

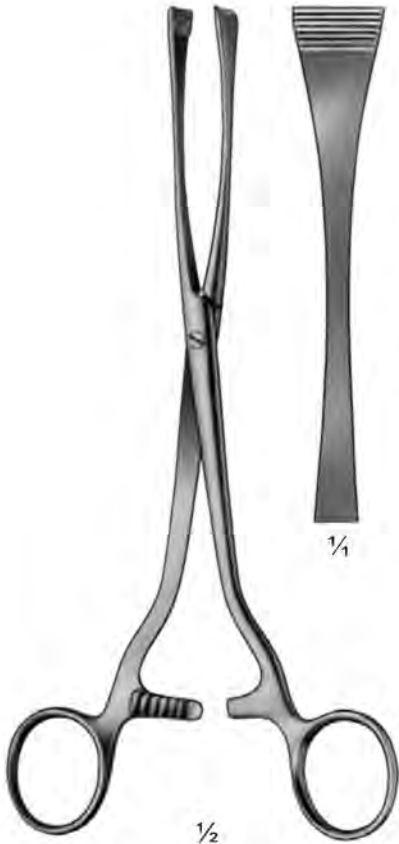

Green-Armytage  
 951-02-22  
 22 cm / 8 3/4"

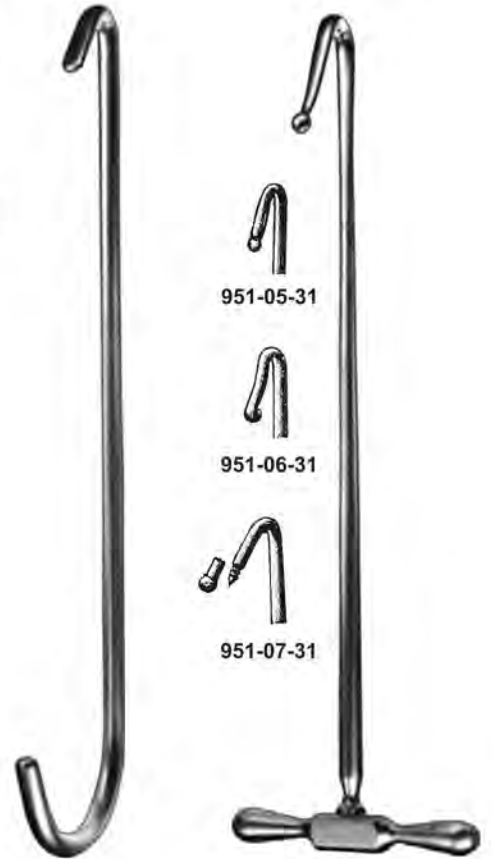

Smellie  
 951-04-30  
 30 cm / 12"

Braun  
 951-05-31 To 951-07-31  
 31 cm / 12 1/4"



Geburts Instrumente  
 Obstetric Instruments  
 Instruments Obstetricaux



Cuzzi  
 952-01-14 To 952-03-21  
 30 cm / 12"  
 Blunt



952-01-14  
 14 mm



952-02-18  
 18 mm



952-03-21  
 21 mm



Pestalozza  
 952-04-30  
 30 cm / 12"



Herff  
 952-05-25  
 25 cm / 10"

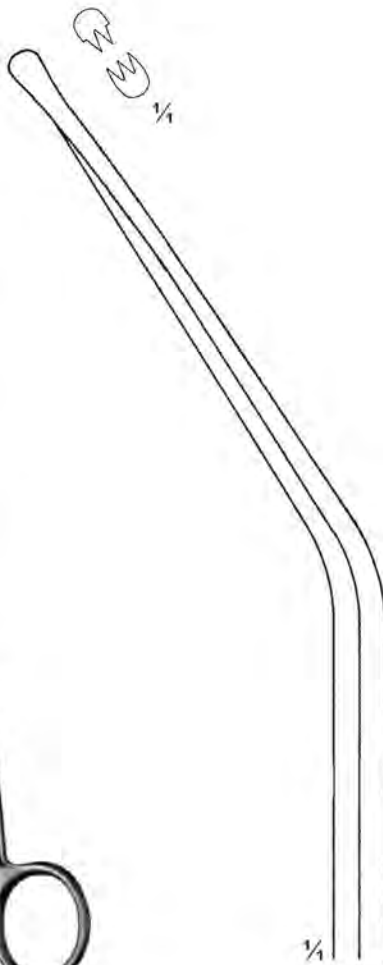

Iowa  
 952-06-26  
 26 cm / 10 1/4"

**Geburts Instrumente  
Obstetric Instruments  
Instruments Obstetricaux**



953-01-10  
10.5 cm / 4 1/4"



Schumacher  
953-02-15  
15 cm / 6"



953-03-13 & 953-04-16



953-03-13  
13.5 cm / 5 1/4"

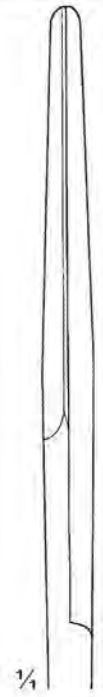

953-04-16  
16 cm / 6 1/4"



Braun-Stadler  
953-05-14 14.5 cm / 5 3/4"  
953-06-20 20 cm / 8"  
Episiotomy Scissors

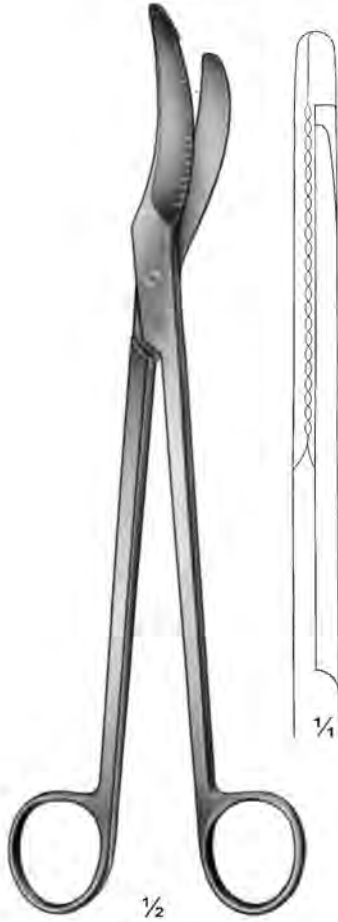

953-07-24  
24 cm / 9 1/2"  
Episiotomy Scissors

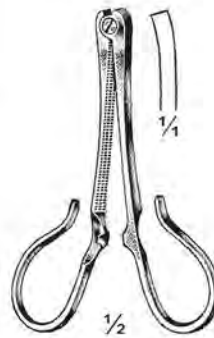

Kane  
953-08-08  
8.5 cm / 3 1/4"



Collin  
953-09-09  
9 cm / 3 1/2"



Collin  
953-10-09  
9 cm / 3 1/2"

Beckenzirkel  
Pelvimeter  
Pelvimètre



1/2

De Lee  
**954-01-15**  
15 cm / 6"  
For interior  
measurements  
between symphysis  
and promontory

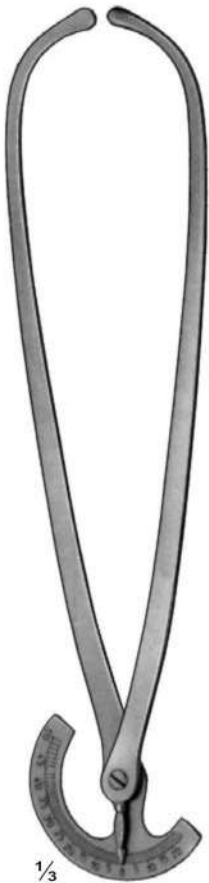

1/3

Collin  
**954-02-34**  
34.5 cm / 13 3/4"  
Graduated in centimeters



**954-03-39**  
39 cm / 15 1/2"  
Graduated in centimeters



Schneider  
**954-04-39**  
39 cm / 15 1/2"  
The additional straight  
arm can be replaced.



Beckenzirkel  
Pelvimeter  
Pelvimètre



1/3

Breisky  
955-01-33  
33 cm / 13 1/4"  
Graduated in centimeters

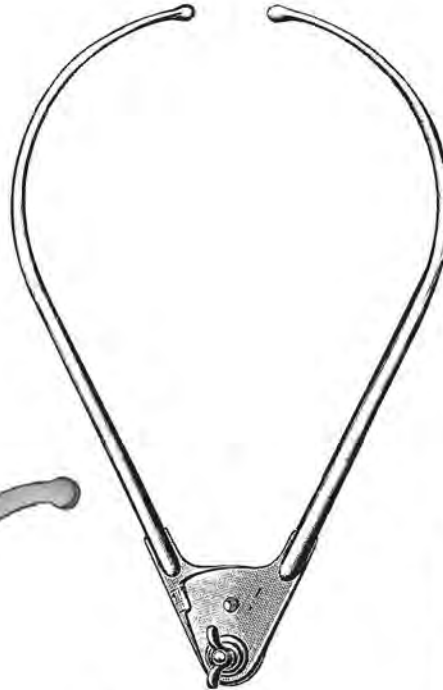

Collyer  
955-02-33  
33 cm / 13 1/4"  
Graduated in centimeters

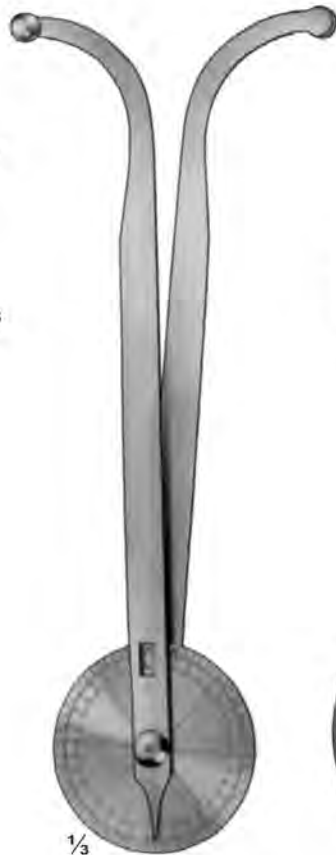

1/3

Thole  
955-03-33  
33 cm / 13 1/4"  
Graduated in centimeters

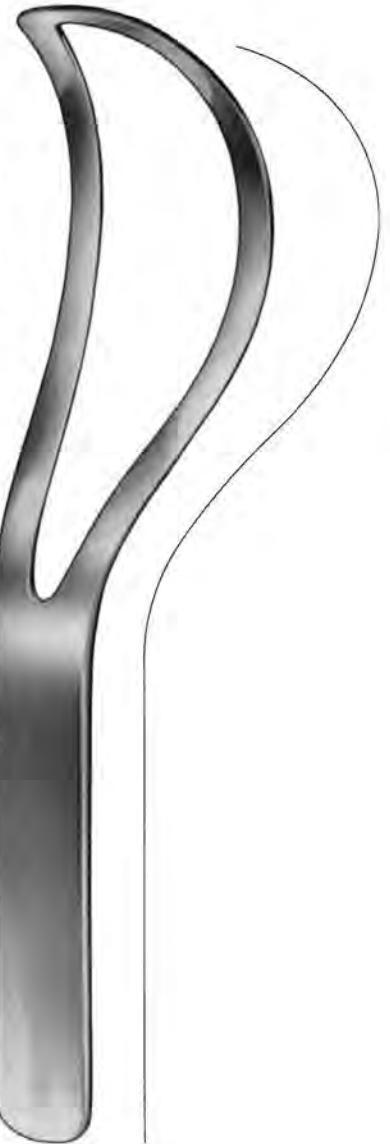

1/2

Sellheim  
955-04-30  
30 cm / 12"

Geburts Instrumente  
 Obstetric Instruments  
 Instruments Obstetricaux

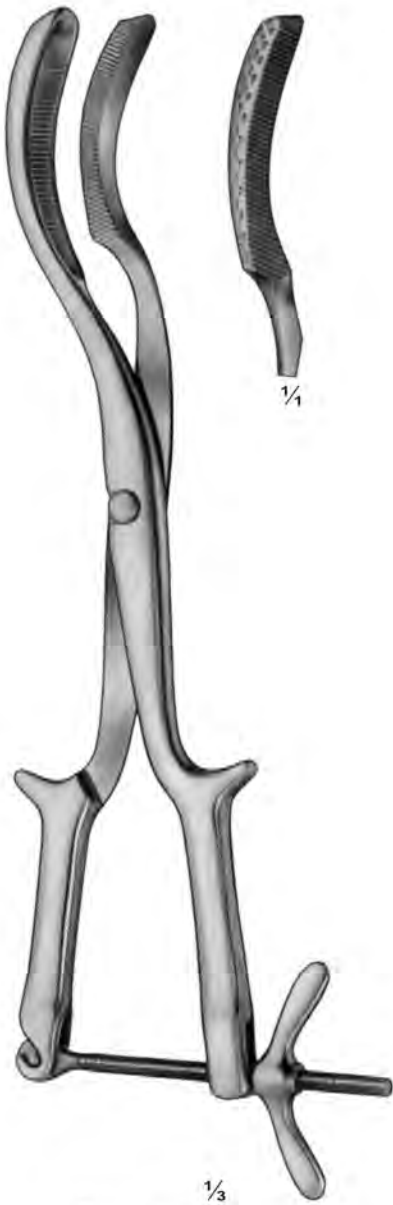

Braun  
 956-01-42  
 42 cm / 16<sup>3</sup>/<sub>4</sub>"  
 1 Jaw fenestrated

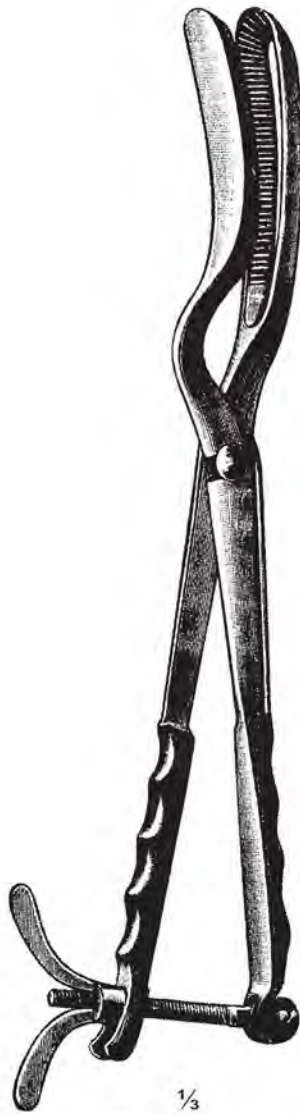

Baren's  
 956-02-42  
 42 cm / 16<sup>3</sup>/<sub>4</sub>"

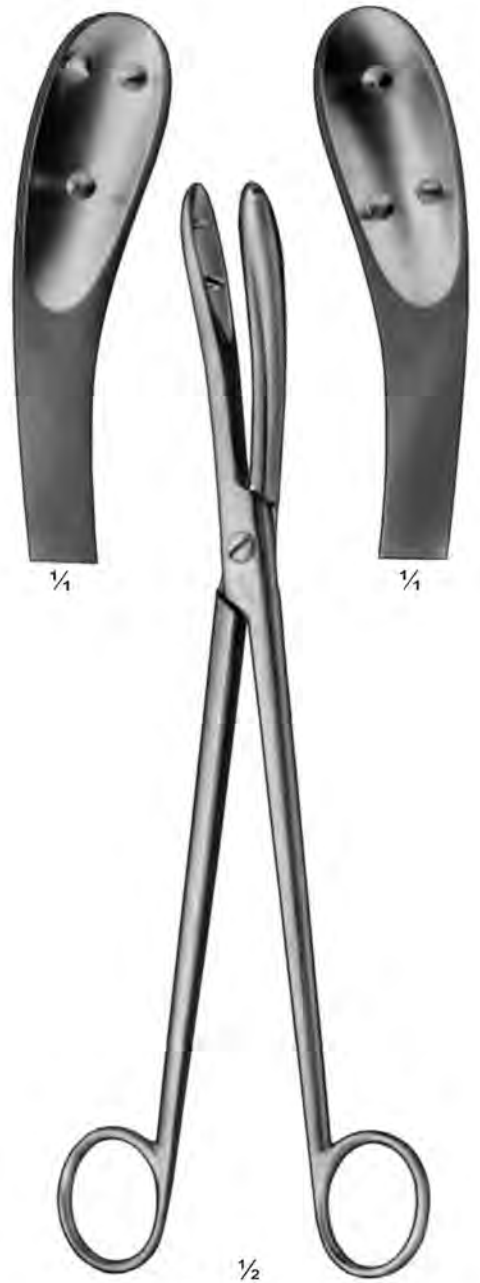

Boer  
 956-03-29  
 29 cm / 11<sup>1</sup>/<sub>2</sub>"  
 Craniotomy forceps

Geburts Instrumente  
 Obstetric Instruments  
 Instruments Obstetricaux



$\frac{1}{3}$   
 Tarnier  
 957-01-44  
 44 cm / 17½"

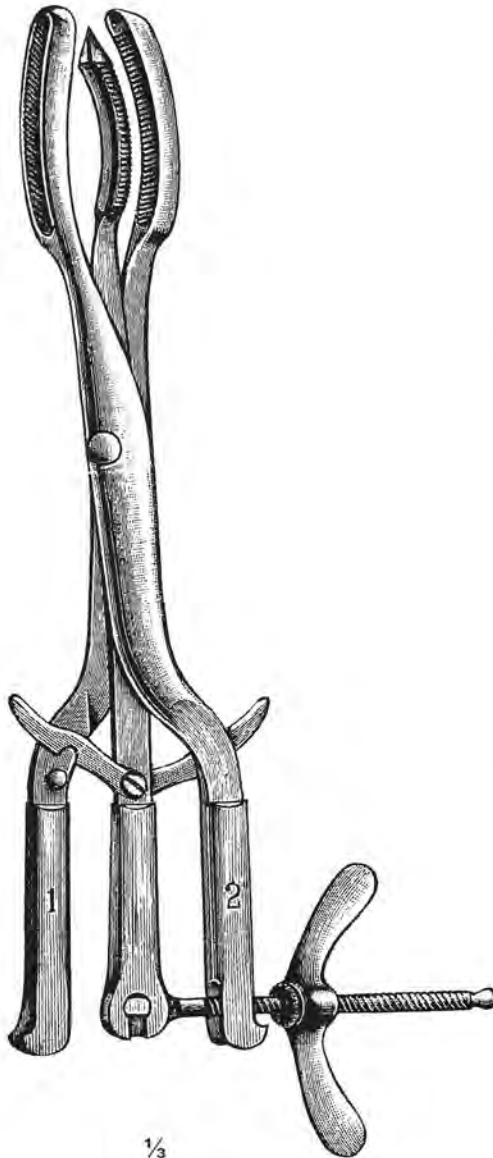

$\frac{1}{3}$   
 Auvard  
 957-02-42  
 42 cm / 16¾"

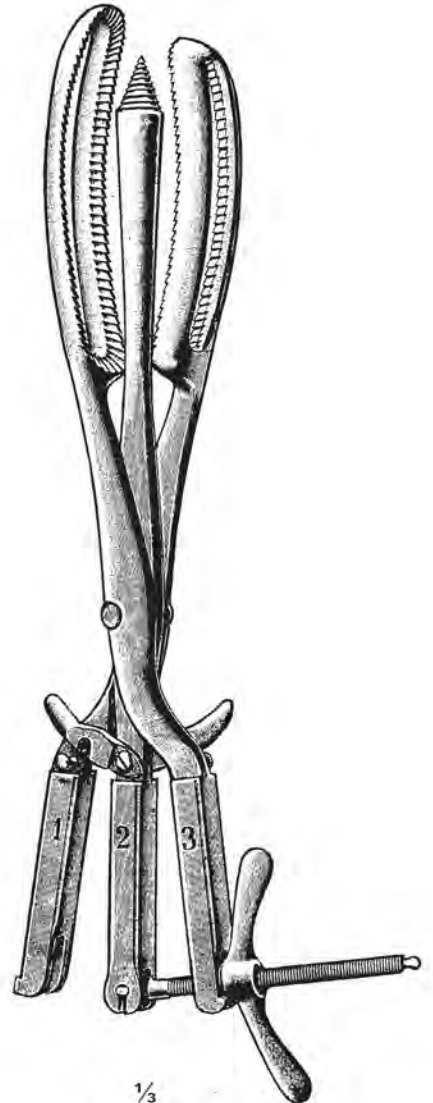

$\frac{1}{3}$   
 Auvard-Zweifel  
 957-03-42  
 42 cm / 16¾"

Beckenzirkel  
Pelvimeter  
Pelvimètre



Naegele  
958-03-35 35 cm / 14"  
958-04-40 40 cm / 16"

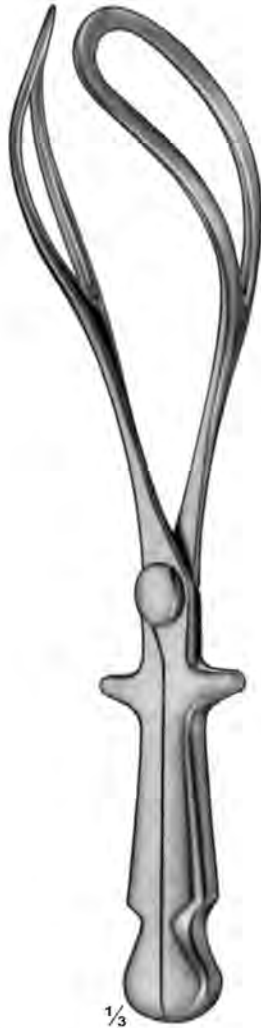

Naegele  
958-05-35 35 cm / 14"  
958-06-40 40 cm / 16"



$\frac{1}{3}$   
Simpson  
958-01-23  
23.5 cm / 9 $\frac{1}{4}$ "



$\frac{1}{3}$   
Wrigley  
958-02-25  
25 cm / 10"



$\frac{1}{3}$   
Boerma  
958-07-28  
28 cm / 11"



1/4

Simpson-Luikart  
959-01-36  
36 cm / 14 1/4"



1/3

Simpson-Braun  
959-02-30  
30 cm / 12"



1/3

Simpson-Braun  
959-03-35  
35 cm / 14"

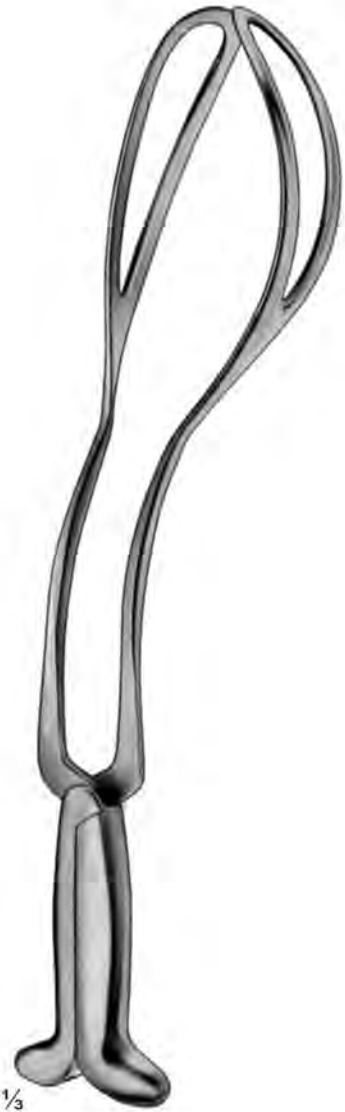

1/3

Piper  
959-04-44  
44.5 cm / 17 1/2"



Beckenzirkel  
Pelvimeter  
Pelvimètre



1/3

Kielland  
960-02-39 39 cm / 15½"  
960-03-42 42 cm / 16¾"



Kielland-Luikart  
960-04-39 39 cm / 15½"  
960-05-42 42 cm / 16¾"



1/4

Luikart  
960-06-39 39 cm / 15½"



1/4

Mc Lean  
960-07-36 36 cm / 14¼"

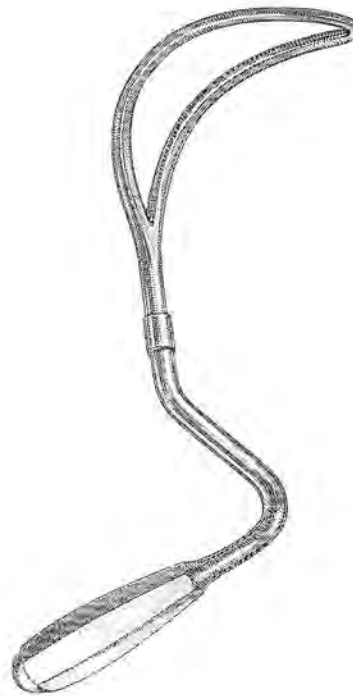

Murless  
960-01-25  
25 cm / 10"  
With hinged shaft  
and sliding collar lock

Beckenzirkel  
Pelvimeter  
Pelvimètre

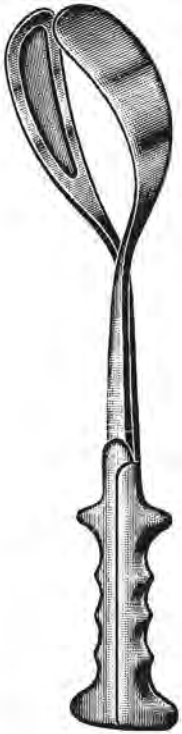

Mc Lean-Luikart  
961-01-38  
38 cm / 15¼"



¼  
De Lee  
961-02-30  
30 cm / 12"

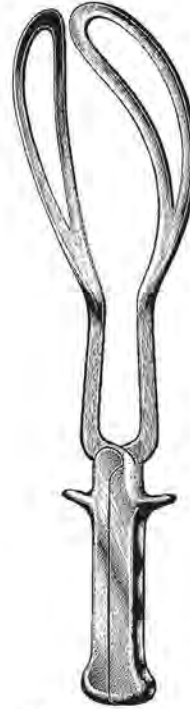

De Lee  
961-03-36 36 cm / 14¼"  
961-04-39 39 cm / 15½"

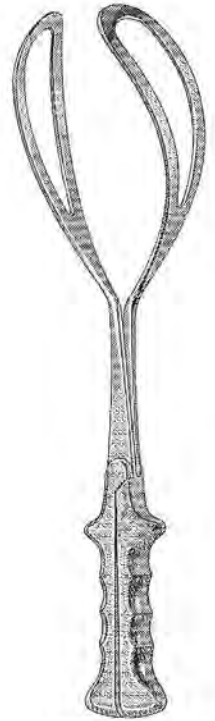

Bailey-Williamson  
961-05-39  
39 cm / 15½"



Hawks-Dennen  
961-06-37  
37.5 cm / 15"



Mc Lean-Tucker-Luikart  
961-07-39  
39.5 cm / 15½"



Dewey  
961-08-35  
35 cm / 14"

Beckenzirkel  
Pelvimeter  
Pelvimètre

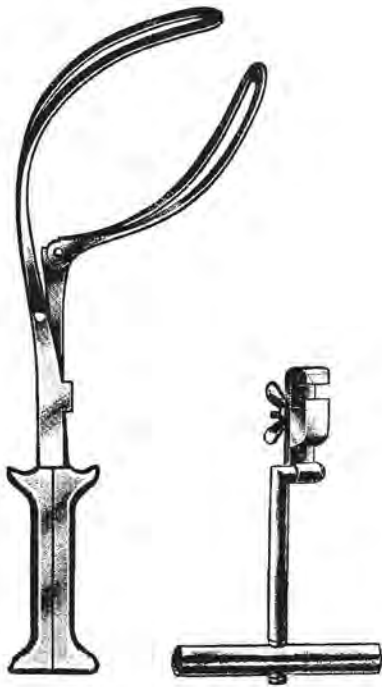

Barton  
962-01-35  
35 cm / 14"  
With traction handle



Barens  
962-02-36 36 cm / 14¼"  
962-03-39 39 cm / 15½"



Anderson  
962-04-39  
39 cm / 15½"



Anderson  
962-05-39  
39 cm / 15½"  
With traction handle



K. N. Dass  
962-06-35  
35 cm / 14"



K. N. Dass  
962-07-35  
35 cm / 14"  
With traction handle

Beckenzirkel  
Pelvimeter  
Pelvimètre

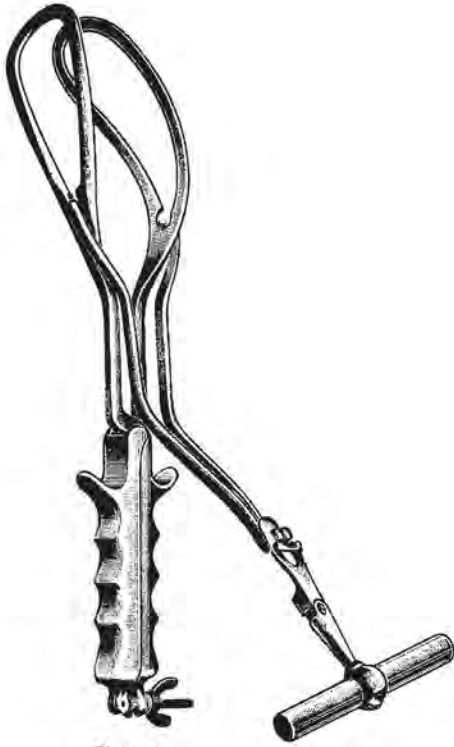

Simpson  
963-01-37  
37 cm / 14 $\frac{3}{4}$ "

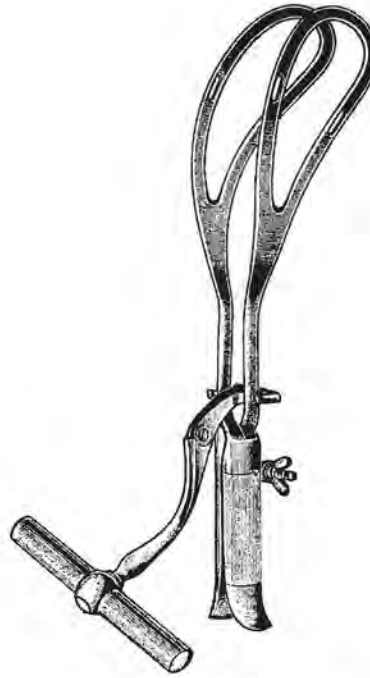

Haig-Fergusson  
963-02-34  
34 cm / 14"

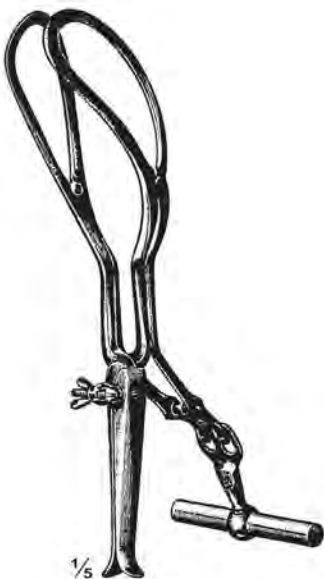

$\frac{1}{6}$   
Milne-Murray  
963-03-38  
38 cm / 15"

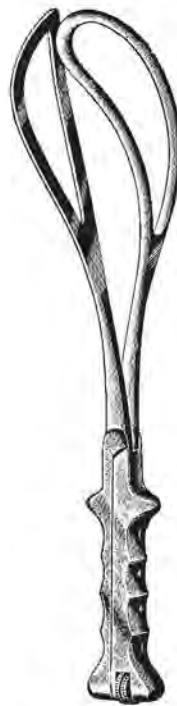

Elliot  
963-04-32 32 cm / 12 $\frac{1}{2}$ "  
963-05-38 38 cm / 15"



Demelis  
963-06-00



Deweys  
964-01-35  
35 cm / 14"  
With traction handle



$\frac{1}{3}$   
Tarnier  
964-02-40  
40 cm / 16"  
With traction rod



$\frac{1}{3}$   
Barnes-Neville  
964-03-43  
43.5 cm / 17"  
With traction handle

**Sterilisierzangen**  
**Sterilizing Forceps**  
**Pinces pour instruments stérilisés**

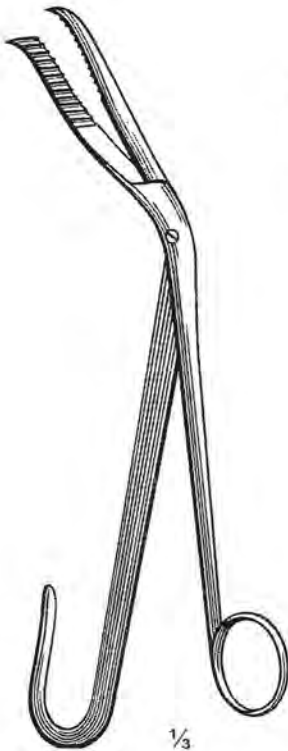

Cheattle  
965-01-28 28 cm / 11"  
965-02-30 30 cm / 12"



1/4



London-Hospital  
965-03-28 28 cm / 11"  
965-04-30 30 cm / 12"



Ulleval  
965-05-24  
24 cm / 9 1/2"

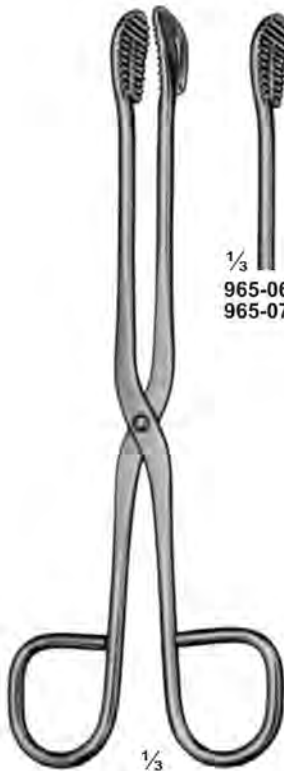

965-06-20 To 965-09-30



965-06-20  
965-07-30



20 cm / 8"  
30 cm / 12"  
965-08-20  
965-09-30



965-10-20 20 cm / 8"  
965-11-25 25 cm / 10"  
965-12-30 30 cm / 12"



Rogge  
965-13-23  
23.5 cm / 9 1/4"

**Sterilisierzangen**  
**Sterilizing Forceps**  
**Pinces pour instruments stérilisés**



Cheattle  
**966-01-28**  
 28 cm / 11"



Cheattle  
**966-02-28**  
 28 cm / 11"

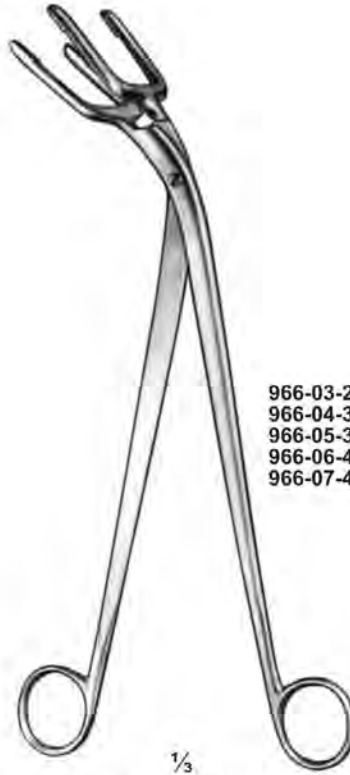

Pye-Smith (Harrison)  
**966-03-25 To 966-07-45**

**966-03-25** 25 cm / 10" **966-08-25**  
**966-04-30** 30 cm / 12" **966-09-30**  
**966-05-35** 35 cm / 14" **966-10-35**  
**966-06-40** 40 cm / 16" **966-11-40**  
**966-07-45** 45 cm / 18" **966-12-45**

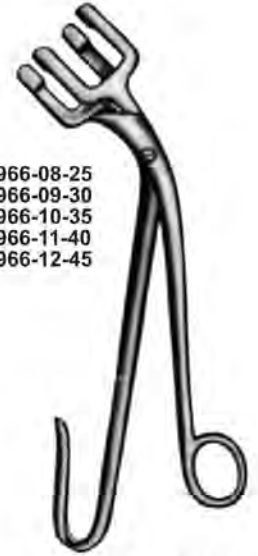

Pye-Smith (Harrison)  
**966-08-25 To 966-12-45**



Collin  
**966-13-24** 24 cm / 9½"  
**966-14-30** 30 cm / 12"



**966-15-23** 23 cm / 9"  
**966-16-30** 30 cm / 12"  
**966-17-50** 50 cm / 20"

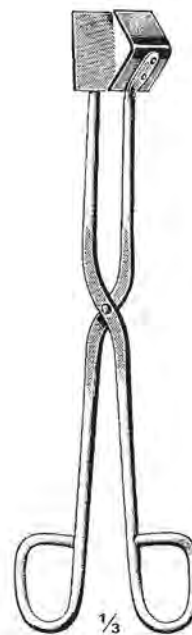

**966-18-24**  
 24 cm / 9½"



**966-18-58**  
 58 cm / 22¾"

**Sterilisierzangen**  
**Sterilizing Forceps**  
**Pinces pour instruments stérilisés**



**967-01-24**  
 24.5 cm / 9¾"



**967-02-24**  
 24 cm / 9½"

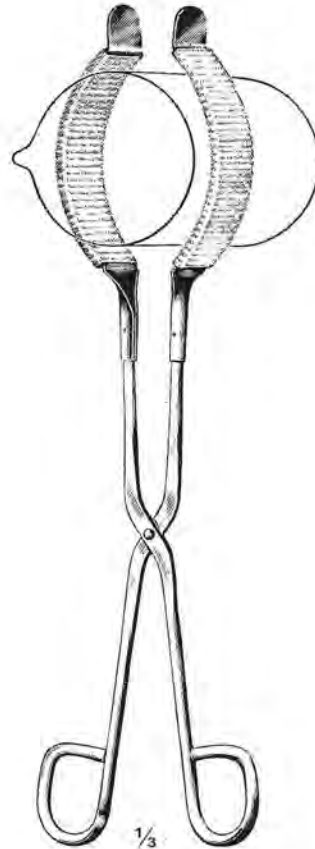

**967-03-33**  
 33 cm / 13"

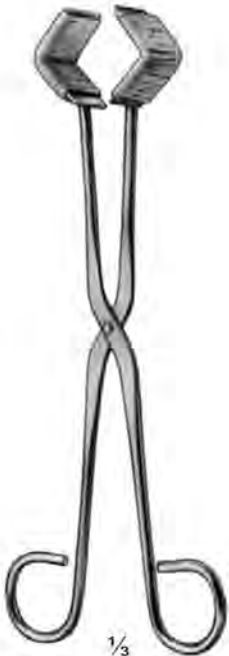

**967-04-25**  
 25 cm / 10"

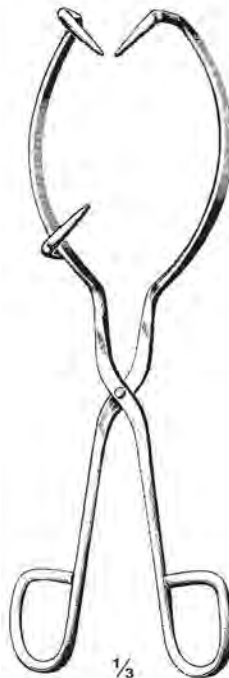

**967-05-26**  
 26 cm / 10¼"



**Sauerbruch**  
**967-06-55**  
 55 cm / 21½"



**Sterilisierzangen**  
**Sterilizing Forceps**  
**Pinces pour instruments stérilisés**



$\frac{1}{3}$   
**968-01-20**  
 20 cm / 8"



**968-02-17**  
 17 cm / 6 $\frac{3}{4}$ "



$\frac{1}{3}$   
 Davis  
**968-03-16** 16 cm / 6 $\frac{1}{4}$ "  
**968-04-20** 20 cm / 8"  
**968-05-24** 24 cm / 9 $\frac{1}{2}$ "

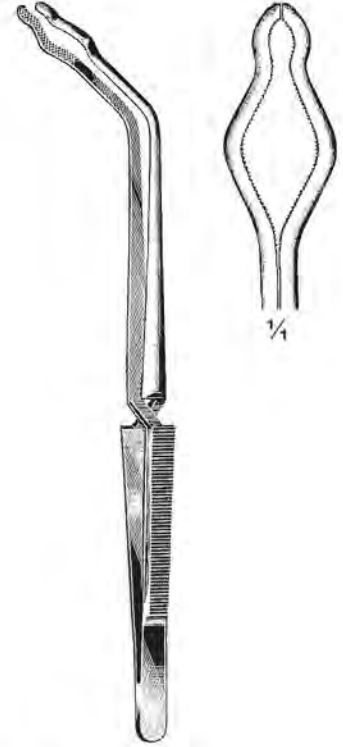

$\frac{1}{4}$   
**968-06-18** 18 cm / 7"  
**968-07-25** 25 cm / 10"



$\frac{1}{2}$   
 Boley  
**968-08-14**  
 14 cm / 5 $\frac{1}{2}$ "  
 Sliding caliper  
 Measuring capacity 0-100 mm



$\frac{1}{2}$   
 Iwanson  
**968-09-12**  
 12 cm / 4 $\frac{3}{4}$ "  
 Decimal spring caliper  
 Measuring capacity 0-10 mm



$\frac{1}{2}$   
**968-10-16**  
 16 cm / 6 $\frac{1}{4}$ "  
 Decimal spring caliper  
 Measuring capacity 0-15 mm

**Sterilisierklammer, Schlauchklemmen  
Safety Pins, Tubing Clamps  
Clips de stérilisation, Pincés presse-tubes**



1/2  
Ulrich  
969-01-06  
6 cm / 2 1/4"



1/2  
Ulrich  
969-02-06  
6 cm / 2 1/4"



1/4  
Simplex  
969-03-12  
12 mm

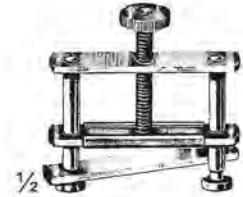

1/2  
Hoffmann  
969-04-13 13 mm  
969-05-17 17 mm  
969-06-20 20 mm  
969-07-25 25 mm  
969-08-30 30 mm  
969-09-40 40 mm  
969-10-50 50 mm



1/2  
For diameter  
969-11-12 12-17 mm  
969-12-16 16-21 mm  
969-13-20 20-25 mm  
969-14-24 24-29 mm



1/2  
Mohr  
969-15-50 50 mm  
969-16-60 60 mm  
969-17-70 70 mm  
969-18-80 80 mm



1/2  
Sell  
969-19-80  
80 mm



1/2  
Holt  
969-20-70  
70 mm

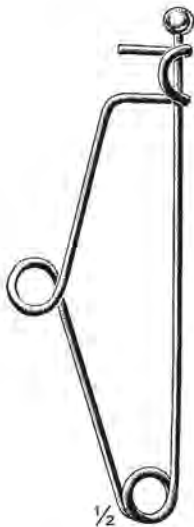

1/2  
Mayo  
969-21-14  
14 cm / 5 1/2"



1/2  
Mayo  
969-22-14  
14 cm / 5 1/2"



1/2  
Bunt  
969-23-12  
12 cm / 4 3/4"

Hollowares  
Hollowares  
Hollowares

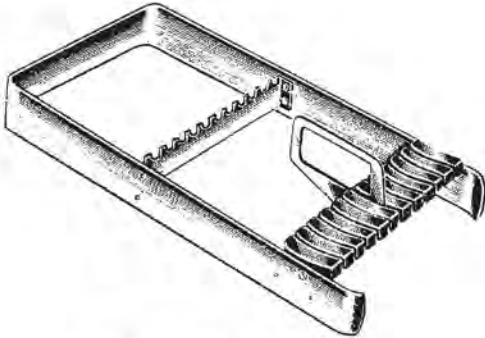

**970-01-220**  
220 X 113 X 45 mm  
For 12 micro instruments  
of 19 cm length

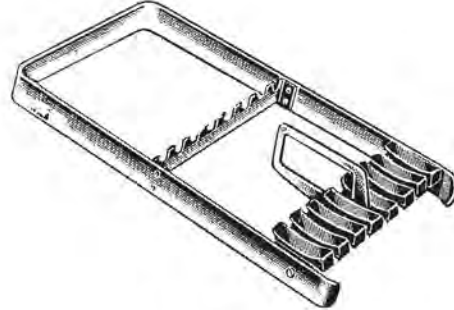

**970-02-190**  
190 X 97 X 32 mm  
For 8 micro instruments  
of 17 cm length

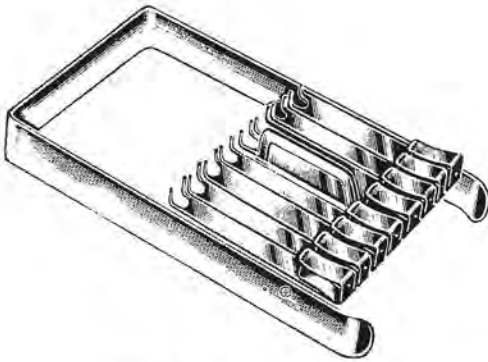

**970-03-220**  
220 X 113 X 45 mm  
For 6 micro instruments  
of 19 cm length

**970-04-220**  
220 X 113 X 45 mm  
For 8 micro instruments  
of 19 cm length



**970-05-120**  
120 X 65 X 13 mm  
Box for bulldog clamps  
Without clamps and silicone tape



**970-06-120**  
120 X 65 X 13 mm  
Box with support for bulldog clamps  
Without clamps



**970-07-120**  
120 X 65 X 13 mm  
Box with support for needle electrodes  
Without instruments



Hakie  
**970-08-00**  
Sterilizing rack

Hollowares  
Hollowares  
Hollowares



**971-01-205**  
205 X 120 X 13 mm  
Perforated lid and bottom



**971-02-150**  
150 X 95 X 13 mm  
Non-perforated lid and bottom



**971-03-150**  
150 X 95 X 13 mm  
Perforated lid and bottom



**971-04-150**  
150 X 95 X 13 mm  
Non-perforated lid and perforated bottom



**971-05-150**  
150 X 95 X 13 mm  
Perforated lid and bottom



**971-06-150**  
150 X 95 X 13 mm  
Non-perforated lid and bottom  
Without rack



**971-07-150**  
150 X 95 X 13 mm  
Perforated lid and bottom  
Without rack



**971-08-150**  
150 X 95 X 7 mm  
Non-Perforated bottom  
Rack only

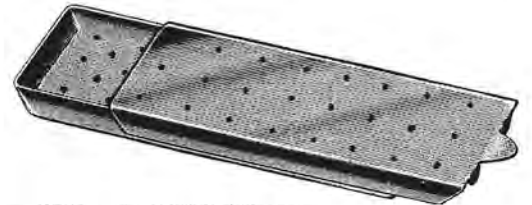

**971-09-50** 50 X 25 X 5 mm  
**971-10-65** 65 X 42 X 8 mm  
**971-11-75** 75 X 25 X 5 mm  
Perforated lid and bottom



**971-12-150**  
150 X 95 X 11 mm  
Perforated bottom  
Rack only

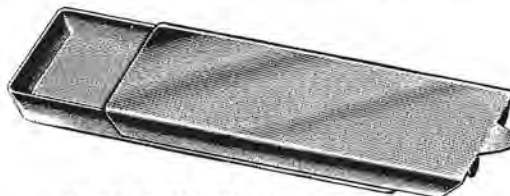

**971-13-50** 50 X 25 X 5 mm  
**971-14-65** 65 X 42 X 8 mm  
**971-15-75** 75 X 25 X 5 mm  
Non-Perforated lid and bottom

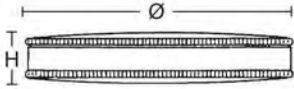

**972-01-65**  
Ø 65 X 15 mm  
Complete



**972-02-62**  
Ø 62 X 12 mm  
Insert only



**972-03-135**  
135 X 100 X 25 mm



**972-04-200** 200 X 100 X 25 mm  
**972-05-230** 230 X 130 X 25 mm  
**972-06-275** 275 X 230 X 25 mm  
Micro Instrument tray with  
silicone mat

Hollowares  
Hollowares  
Hollowares



	L	B	H
973-01-240	240 X	240 X	50 mm
973-02-240	240 X	240 X	80 mm
973-03-240	240 X	240 X	100 mm
973-04-480	480 X	260 X	50 mm
973-05-520	520 X	260 X	80 mm
973-06-520	520 X	260 X	100 mm

Perforated steel sheet



**973-07-00**  
Storing cup for micro instruments  
with silicon bottom plate



**973-08-00**  
Sterilizing forceps consisting of :  
1 Sterilizing forceps, 25cm, Cur  
without ratchet, with lid for jar  
1 Jar with wide bottom plate (anti-tilt)  
**973-09-32** Complete with 32 cm long Sterilizing Forceps



# Hollowares Hollowares Hollowares

Containers	L	B	H	Set of special filters (5pairs)
974-01-230	230 X	130 X	50	974-17-230
974-02-26	260 X	150 X	50	974-18-260
974-03-275	275 X	235 X	50	974-19-275
974-04-300	300 X	200 X	50	974-20-300
974-05-325	325 X	275 X	50	974-21-35
974-06-400	400 X	200 X	50	974-22-400
974-07-420	420 X	175 X	50	974-23-420
974-08-500	500 X	200 X	50	974-24-500
974-09-230	230 X	130 X	75	974-25-230
974-10-260	260 X	150 X	75	974-26-260
974-11-275	275 X	235 X	75	974-27-275
974-12-300	300 X	200 X	75	974-28-300
974-13-325	325 X	275 X	75	974-29-325
974-14-400	400 X	200 X	75	974-30-400
974-15-420	420 X	175 X	75	974-31-420
974-16-500	500 X	200 X	75	974-32-500

Perforated lid

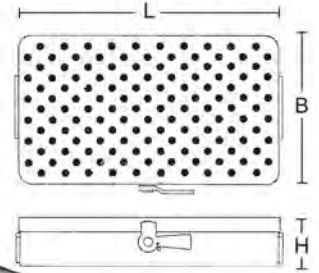

974-33-135    Ø    H  
Lid with knob    135 X 40  
974-34-135    135 X 40  
Lid without knob

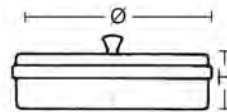

974-35-135    Ø    H  
Lid with knob    135 X 40  
974-36-135    135 X 40  
Lid without knob  
Perforated lid



974-37-200    L    B    H  
Lid with knob    200 X 100 X 40  
974-38-200    200 X 100 X 40  
Lid without knob



974-39-200    L    B    H  
Lid with knob    200 X 100 X 40  
974-40-200    200 X 100 X 40  
Lid without knob  
Perforated lid



Perforated bottom	L	B	H	Non-Perforated bottom
974-41-195	195 X	95 X	35	974-47-195
974-42-225	225 X	125 X	40	974-48-225
974-43-255	255 X	145 X	40	974-49-255
974-44-295	295 X	195 X	40	974-50-295
974-45-320	320 X	270 X	40	974-51-320
974-46-415	415 X	170 X	40	974-52-415

Hollowares  
Hollowares  
Hollowares



**975-01-245**  
245 X 135 X 35 mm  
Perforated bottom



Perforated bottom  
of 975-01-245 To 975-03-245



**975-02-245**  
245 X 135 X 50 mm  
Perforated bottom



**975-03-245**  
245 X 135 X 60 mm  
Perforated bottom



**975-04-00** Stand Only  
**975-05-00**  
Complete consisting of :  
1 Pc Stand  
3 Pcs Box 975-03-245  
1 Pc Box 975-02-245  
1 Pc Box 975-01-245





Konrich  
976-01-140 To 976-56-390

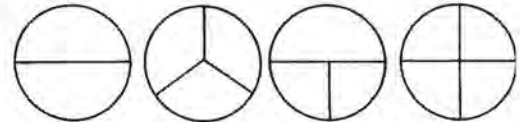

Ø	H				
140 X 140 mm		976-01-140	976-15-140	976-29-140	976-43-140
160 X 150 mm		976-02-160	976-16-160	976-30-160	976-44-160
190 X 160 mm		976-03-190	976-17-190	976-31-190	976-45-190
190 X 190 mm		976-04-190	976-18-190	976-32-190	976-46-190
240 X 120 mm		976-05-240	976-19-240	976-33-240	976-47-240
240 X 160 mm		976-06-240	976-20-240	976-34-240	976-48-240
240 X 240 mm		976-07-240	976-21-240	976-35-240	976-49-240
290 X 160 mm		976-08-290	976-22-290	976-36-290	976-50-290
290 X 240 mm		976-09-290	976-23-290	976-37-290	976-51-290
340 X 160 mm		976-10-340	976-24-340	976-38-340	976-52-340
340 X 240 mm		976-11-340	976-25-340	976-39-340	976-53-340
390 X 140 mm		976-12-390	976-26-390	976-40-390	976-54-390
390 X 190 mm		976-13-390	976-27-390	976-41-390	976-55-390
390 X 290 mm		976-14-390	976-28-390	976-42-390	976-56-390



Schimmelbusch  
976-57-140 To 976-112-390

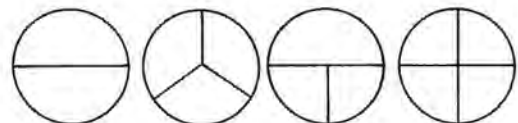

Ø	H				
140 X 140 mm		976-57-140	976-71-140	976-85-140	976-99-140
160 X 150 mm		976-58-160	976-72-160	976-86-160	976-100-160
190 X 160 mm		976-59-190	976-73-190	976-87-190	976-101-190
190 X 190 mm		976-60-190	976-74-190	976-88-190	976-102-190
240 X 120 mm		976-61-240	976-75-240	976-89-240	976-103-240
240 X 160 mm		976-62-240	976-76-240	976-90-240	976-104-240
240 X 240 mm		976-63-240	976-77-240	976-91-240	976-105-240
290 X 160 mm		976-64-290	976-78-290	976-92-290	976-106-290
290 X 240 mm		976-65-290	976-79-290	976-93-290	976-107-290
340 X 160 mm		976-66-340	976-80-340	976-94-340	976-108-340
340 X 240 mm		976-67-340	976-81-340	976-95-340	976-109-340
390 X 140 mm		976-68-390	976-82-390	976-96-390	976-110-390
390 X 190 mm		976-69-390	976-83-390	976-97-390	976-111-390
390 X 290 mm		976-70-390	976-84-390	976-98-390	976-112-390



Without partition

	L	B	H
977-01-15	15 X 15 X 15 mm		
977-02-20	20 X 19 X 18 mm		
977-03-30	30 X 30 X 15 mm		
977-04-30	30 X 30 X 20 mm		
977-05-30	30 X 30 X 30 mm		
977-06-60	60 X 30 X 15 mm		
977-07-60	60 X 30 X 20 mm		
977-08-60	60 X 30 X 30 mm		

Without partition

	L	B	H
977-09-275	275 X 275 X 130 mm		
977-10-275	275 X 275 X 200 mm		
977-11-275	275 X 275 X 260 mm		
977-12-575	575 X 275 X 130 mm		
977-13-575	575 X 275 X 260 mm		
977-14-575	575 X 275 X 260 mm		



With single partition

	L	B	H
977-15-275	275 X 275 X 130 mm		
977-16-275	275 X 275 X 200 mm		
977-17-275	275 X 275 X 260 mm		
977-18-575	575 X 275 X 130 mm		
977-19-575	575 X 275 X 260 mm		
977-20-575	575 X 275 X 260 mm		

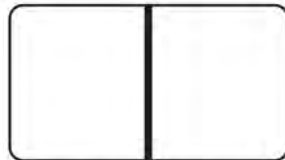

With quarter partition

	L	B	H
977-21-275	275 X 275 X 130 mm		
977-22-275	275 X 275 X 200 mm		
977-23-275	275 X 275 X 260 mm		
977-24-575	575 X 275 X 130 mm		
977-25-575	575 X 275 X 260 mm		
977-26-575	575 X 275 X 260 mm		



	Ø	H
977-27-65	65 X 200	
977-28-65	65 X 250	
977-29-65	65 X 320	
977-30-65	65 X 370	
977-31-65	65 X 405	
977-32-65	65 X 450	
977-33-65	65 X 500	

	Ø	H
977-34-65	65 X 380	
977-35-65	65 X 420	
977-36-65	65 X 450	



Alexander  

	Ø	H
978-01-80	80	X 250 mm
978-02-80	80	X 320 mm
978-03-80	80	X 370 mm
978-04-80	80	X 430 mm
978-05-80	80	X 450 mm
978-06-80	80	X 500 mm
978-07-80	80	X 550 mm



	Ø	H
978-08-125	125	X 310 mm
978-09-125	125	X 310 mm

With rack  
Without rack



	Ø	H
978-10-120	120	X 250 mm
978-11-120	120	X 250 mm

With rack  
Without rack

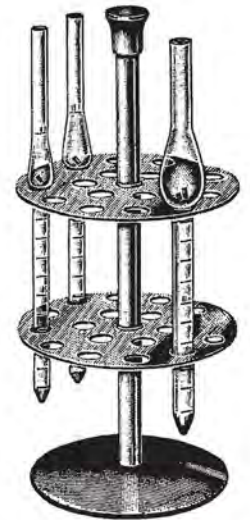

	Ø	H
978-12-60	60	X 140 mm
978-13-60	60	X 140 mm

With rack  
Without rack

Hollowares  
Hollowares  
Hollowares



	L	B	H
979-01-275	275 X	275 X	70 mm
979-02-275	275 X	275 X	130 mm
979-03-275	275 X	275 X	260 mm
979-04-575	575 X	275 X	70 mm
979-05-575	575 X	275 X	130 mm
979-06-575	575 X	275 X	260 mm

Perforated lid and bottom



	L	B	H
979-07-275	275 X	275 X	70 mm
979-08-275	275 X	275 X	130 mm
979-09-275	275 X	275 X	260 mm
979-10-575	575 X	275 X	70 mm
979-11-575	575 X	275 X	130 mm
979-12-575	575 X	275 X	260 mm

Perforated lid and non-perforated bottom



Hollowares  
Hollowares  
Hollowares



	L	B	H
980-01-275	275	275	130
980-02-275	275	275	260
980-03-575	575	275	130
980-04-575	575	275	260

Non-perforated lid and bottom



	L	B	H
980-05-275	275	275	70
980-06-275	275	275	130
980-07-275	275	275	200
980-08-275	275	275	260
980-09-575	575	275	70
980-10-575	575	275	130
980-11-575	575	275	200
980-12-575	575	275	260

Perforated lid and bottom



**Hollowares  
Hollowares  
Hollowares**



	Capacity in ltr.
981-01-01	1.0
981-02-01	1.5
981-03-02	2.0



	Capacity in ltr.
981-04-01	1.0
981-05-01	1.5
981-06-02	2.0



	Capacity in ltr.
981-07-01	1.0
981-08-02	2.0
981-09-03	3.0
981-10-04	5.0



	Capacity in ltr.
981-11-05	0.5
981-12-01	1.0
981-13-02	2.0
981-14-03	3.0



With lid	Without lid	Lid Only
981-15-30	981-24-30	981-33-30
981-16-50	981-25-50	981-34-50
981-17-50	981-26-50	981-35-50
981-18-50	981-27-50	981-36-50
981-19-75	981-28-75	981-37-75
981-20-75	981-29-75	981-38-75
981-21-75	981-30-75	981-39-75
981-22-100	981-31-100	981-40-100
981-23-100	981-32-100	981-41-100

Lid only with triangle hole	Ø	H
981-42-30	30 X	90 mm
981-43-50	50 X	100 mm
981-44-50	50 X	130 mm
981-45-50	50 X	175 mm
981-46-75	75 X	100 mm
981-47-75	75 X	130 mm
981-48-75	75 X	175 mm
981-49-100	100 X	175 mm
981-50-100	100 X	200 mm



Lid with knob	Lid without knob	Ø	H
981-51-30	981-69-30	30 X	60 mm
981-52-75	981-70-75	75 X	75 mm
981-53-75	981-71-75	75 X	60 mm
981-54-100	981-72-100	100 X	100 mm
981-55-100	981-73-100	100 X	80 mm
981-56-100	98 1-74-100	125 X	125 mm
981-57-125	981-75-125	125 X	20 mm
981-58-135	981-76-135	135 X	35 mm
981-59-135	981-77-135	135 X	50 mm
981-60-135	981-78-135	135 X	100 mm
981-61-150	981-79-150	150 X	150 mm
981-62-150	981-80-150	150 X	100 mm
981-63-200	981-81-200	200 X	150 mm
981-64-200	981-82-200	200 X	200 mm
981-65-240	981-83-240	240 X	160 mm
981-66-240	981-84-240	240 X	230 mm
981-67-290	981-85-290	290 X	160 mm
981-68-290	981-86-290	290 X	240 mm



Satin finish	Mirror finish	Ø	H	Capacity Ltr
982-01-075	982-13-075	165 X	60 mm	0.75
982-02-01	982-14-01	170 X	70 mm	1.00
982-03-02	982-15-02	220 X	80 mm	2.00
982-04-02	982-16-02	225 X	90 mm	2.50
982-05-03	982-17-03	240 X	110 mm	3.00
982-06-04	982-18-04	255 X	115 mm	4.00
982-07-04	982-19-04	275 X	115 mm	4.50
982-08-06	982-20-06	290 X	125 mm	6.00
982-09-06	982-21-06	310 X	120 mm	6.00
982-10-08	982-22-08	345 X	125 mm	8.50
982-11-11	982-23-11	380 X	130 mm	11.00
982-12-14	982-24-14	415 X	140 mm	14.00

Satin finish	Mirror finish	Ø	H
982-25-330	982-27-330	330 X	90 mm
982-26-330	982-28-330	330 X	115 mm



982-29-110 Satin finish  
982-30-110 Mirror finish  
Ø 110 X 28 mm



Satin finish	Mirror finish	Ø	H	Capacity Ltr
982-31-05	982-38-05	40 X	19 mm	0.05
982-32-07	982-39-07	61 X	30 mm	0.07
982-33-035	982-40-035	116 X	50 mm	0.35
982-34-045	982-41-045	128 X	55 mm	0.45
982-35-070	982-42-070	147 X	65 mm	0.70
982-36-01	982-43-01	167 X	75 mm	1.10
982-37-01	982-44-01	187 X	85 mm	1.60



Satin finish	Mirror finish	Ø	H	Capacity Ltr
982-45-030	982-50-030	116 X	35 mm	0.30
982-46-040	982-50-040	128 X	38 mm	0.40
982-47-050	982-52-050	147 X	40 mm	0.50
982-48-075	982-53-075	157 X	45 mm	0.75
982-49-01	982-54-01	187 X	45 mm	1.00

Hollowares  
Hollowares  
Hollowares



With lid	Without lid	Ø	H	Capacity Ltr
983-01-020	983-03-020	110	27 mm	0.20
983-02-030	983-04-030	110	40 mm	0.30



	Ø	H	
983-05-100	100	20 mm	With lid
983-06-96	96	20 mm	Dish only
983-07-100	100	16 mm	Lid only



	Ø	H	
983-08-96	96	20 mm	
983-09-100	100	20 mm	
983-10-100	100	16 mm	With lid



983-11-00  
Partition only  
For 983-05-100 To 983-10-100



983-12-100  
100 cc = 0.11



983-13-025	0.25 l
983-14-050	0.50 l
983-15-01	1.00 l
983-16-02	2.00 l



983-17-25  
25 cc



983-18-50  
50 cc



983-19-20  
20 cc



983-20-75  
Ø 75 X 12 mm



Hollowares  
Hollowares  
Hollowares



**984-01-125**  
125 X 80 X 12 mm



	L	B	H
<b>984-02-55</b>	55 X	29 X	6 mm
<b>984-03-75</b>	75 X	29 X	6 mm
<b>984-04-90</b>	90 X	37 X	6 mm



	L	B	H
<b>984-05-55</b>	55 X	29 X	6 mm
<b>984-06-75</b>	75 X	29 X	6 mm
<b>984-07-90</b>	90 X	37 X	6 mm

Perforated bottom



	L	B	H
<b>984-08-235</b>	235 X	190 X	40 mm
<b>984-09-330</b>	330 X	230 X	30 mm
<b>984-10-330</b>	330 X	230 X	50 mm
<b>984-11-350</b>	350 X	250 X	30 mm
<b>984-12-350</b>	350 X	250 X	50 mm



	L	B	H
<b>984-13-210</b>	210 X	160 X	10 mm
<b>984-14-240</b>	240 X	180 X	10 mm
<b>984-15-310</b>	310 X	150 X	10 mm
<b>984-16-310</b>	310 X	210 X	10 mm
<b>984-17-350</b>	350 X	240 X	10 mm
<b>984-18-400</b>	400 X	270 X	20 mm
<b>984-19-420</b>	420 X	280 X	10 mm



**984-20-250**  
250 X 115 X 15 mm



**984-21-250**  
250 X 115 X 15 mm



**984-22-250**  
250 X 115 X 15 mm

Hollowares  
Hollowares  
Hollowares



**985-01-235**  
235 X 190 X 40 mm



**985-02-220**  
Ø 220 X 70 mm



Krenn  
**985-03-193**  
193 X 163 X 13 mm



Krenn  
**985-04-193**  
193 X 163 X 13 mm



	L	B	H
<b>985-05-200</b>	200	150	50
<b>985-06-225</b>	225	150	50
<b>985-07-250</b>	250	200	50
<b>985-08-275</b>	275	175	50
<b>985-09-300</b>	300	200	50
<b>985-10-300</b>	300	250	50
<b>985-11-350</b>	350	250	50
<b>985-12-375</b>	375	300	50
<b>985-13-450</b>	450	300	50



**985-14-200**  
200 X 75 X 40 mm



**985-15-305**  
305 X 215 X 50 mm  
Midwifery box



Without knob  
986-01-165  
986-02-200  
986-03-200  
986-04-230  
986-05-260  
986-06-270  
986-07-300  
986-08-325  
986-09-325  
986-10-420  
986-11-420  
986-12-575

With knob  
986-13-165  
986-14-200  
986-15-200  
986-16-230  
986-17-260  
986-18-270  
986-19-300  
986-20-325  
986-21-325  
986-22-420  
986-23-420  
986-24-575

With handle  
986-25-165  
986-26-200  
986-27-200  
986-28-230  
986-29-260  
986-30-270  
986-31-300  
986-32-325  
986-33-325  
986-34-420  
986-35-420  
986-36-575

With flat handle  
986-37-165  
986-38-200  
986-39-200  
986-40-230  
986-41-260  
986-42-270  
986-43-300  
986-44-325  
986-45-325  
986-46-420  
986-47-420  
986-48-575

L	B	H
165 X	85 X	35 mm
200 X	100 X	35 mm
200 X	100 X	35 mm
230 X	130 X	50 mm
260 X	150 X	50 mm
270 X	235 X	50 mm
300 X	200 X	50 mm
325 X	275 X	30 mm
325 X	275 X	50 mm
420 X	80 X	40 mm
420 X	175 X	50 mm
575 X	275 X	100 mm

986-49-205  
205 X 105 X 40 mm



986-50-100 Ø 100 mm  
986-51-120 Ø 120 mm  
986-52-150 Ø 150 mm



986-53-90  
Ø 90 X 90 mm



986-54-75  
Ø 75 X 50 mm



986-55-75  
Ø 75 X 80 mm



986-56-75  
Ø 75 X 80 mm



986-57-75  
Ø 75 X 80 mm



986-58-73  
Ø 73 X 75 mm



986-59-100  
Ø 100 X 50 mm

**Hollowares  
Hollowares  
Hollowares**



Tray with lid	Tray only	Lid only	Length
987-01-15	987-05-15	987-09-15	15 cm / 6"
987-02-20	987-06-20	987-10-20	20 cm / 8"
987-03-25	987-07-25	987-11-25	25 cm / 10"
987-04-30	987-08-30	987-12-30	30 cm / 12"



**987-13-750**  
Male  
Capacity 750 ml



**987-14-750**  
Female  
Capacity 750 ml



**987-15-00**



**987-16-350**  
350 X 180 mm



**987-17-00**



**987-18-387**  
387 X 156 mm  
Slipper type with cover

**Hollowares  
Hollowares  
Hollowares**



**988-01-00**



**988-02-312**  
312 x 362 mm  
Perfection type with lid



**988-03-00**  
With lid



**988-04-220** With lid  
**988-05-220** Without lid  
Ø 220 X 120 mm



**988-06-340**  
Ø 340 mm



**988-07-235** Ø 235 mm  
**988-08-310** Ø 310 mm  
With lid



	With cover	Without cover	Ø	H	Capacity ltr.
	<b>988-09-295</b>	<b>988-12-295</b>	295	230	10
	<b>988-10-310</b>	<b>988-13-310</b>	310	265	12
	<b>988-11-325</b>	<b>988-14-325</b>	325	305	15

Hollowares  
Hollowares  
Hollowares



1/2  
**989-01-50**  
Ø 50 x 100 mm  
With lid



1/2  
**989-02-75**  
Ø 75 x 90 mm  
With lid



1/2  
**989-03-75** Ø 75 x 90 mm  
**989-04-100** Ø 100 x 130 mm  
With lid



1/2  
Methot  
**989-05-50**  
Ø 50 x 75 mm



1/2  
Methot  
**989-06-50** With lid  
**989-07-50** Without lid  
Ø 50 x 75 mm

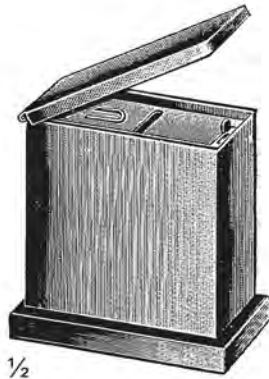

1/2  
Luniatschek  
**989-08-60**  
60 X 60 X 30 mm



1/2  
Phillip  
**989-09-75**  
Ø 75 X 115 mm  
With lid



1/2  
Phillip  
**989-10-75**  
Ø 75 X 100 mm  
With insert



# SURGICAL INSTRUMENT SETS

## GENERAL SURGERY

### BASIC LAPAROTOMY SET

Quantity	Cat. Ref.	Description
1 each	234-05	Yankauer Suction Tube
6 each	969-22	Mayo Forceps Holder, 20cm
2 each	20-01	Scalpel Handle No. 3
2 each	20-05	Scalpel Handle No. 4
1 each	21-04	Scalpel Handle No. 7
2 each	61-02	Mayo Operating Scissors, 17cm, Str
2 each	61-05	Mayo Operating Scissors, 17cm, Cur
1 each	70-07	Metzenbaum Scissors, 18cm, Cur
1 each	70-03	Metzenbaum Scissors, 23cm, Str, T/C
1 each	70-09	Metzenbaum Scissors, 23cm, Cur, T/C
2 each	129-03	Standard Dressing Forceps, 14cm
2 each	128-16	Tissue Forceps, 14cm, 1x2T
2 each	139-02	Hudson Tissue Forceps, 20cm, 1x2T
2 each	138-14	Russian Tissue Forceps, 20cm
6 each	162-01	Halstead Mosquito Forceps, 12.5cm, Str
6 each	162-05	Halstead Mosquito Forceps, 12.5cm, Cur
18 each	164-01	Kelly Forceps 14cm, Str
18 each	164-02	Kelly Forceps 14cm, Cur
6 each	168-03	Rochester-Pean Forceps, 16cm, Str
4 each	168-08	Rochester-Pean Forceps, 26cm, Str
4 each	175-07	Kocher-Ochsner Forceps, 25cm, Str, 1x2T
2 each	187-04	Mixer Forceps, 22cm
8 each	211-06	Backhaus Towel Forceps, 13cm
3 each	215-17	Foerster Sponge Forceps, 24cm, Str, Serr.
2 each	261-02	Mayo-Hegar Needle Holder, 18cm, T/C
1 each	261-03	Mayo-Hegar Needle Holder, 20cm, T/C
2 each	261-05	Mayo-Hegar Needle Holder, 26cm, T/C
1 each	234-01	Pool Suction Tube, Str
2 each	352-06	Goelet Retractor, 6mm Ø
1 each	377-05	Parker-Langenbeck Retractor, Set of 2
1 each	374-16	Retractor, 30mm
1 each	374-17	Retractor, 40mm
1 each	374-18	Retractor, 50mm
1 each	364-03	Deaver Retractor
1 each	364-04	Deaver Retractor
1 each	365-05	Deaver Retractor
1 each	347-01	Richardson Retractor, Small
1 each	347-02	Richardson Retractor, Medium
1 each	347-03	Richardson Retractor, Large
1 each	407-05	Balfour Retractor
4 each	188-07	Lahey Gall Duct Forceps, 19cm
4 each	767-07	Allis Tissue Forceps, 15cm, 4x5T
2 each	767-10	Allis Tissue Forceps, 25cm
4 each	769-06	Babcock Tissue Forceps, 16cm
2 each	769-08	Babcock Tissue Forceps, 24cm
4 each	177-10	Schmidt Tonsil Forceps, 19cm
2 each	842-02	De Bakey Tissue Forceps, 20cm

### MINOR BASIC INSTRUMENT SET

Quantity	Cat. Ref.	Description
1 each	20-01	Scalpel Handle No. 3
1 each	20-05	Scalpel Handle No. 4
1 each	58-13	Operating Scissors, 14cm, Str, Sh/Bl
1 each	61-02	Mayo Operating Scissors, 17cm, Str
1 each	70-07	Metzenbaum Scissors, 18cm, Cur
1 each	129-29	Tissue Forceps, 14cm, 1x2T
1 each	129-03	Standard Dressing Forceps, 14cm
4 each	162-01	Halstead Mosquito Forceps, 12.5cm, Str
4 each	162-05	Halstead Mosquito Forceps, 12.5cm, Cur
4 each	164-02	Kelly Forceps, Cur
6 each	211-06	Backhaus Towel Forceps, 13cm
2 each	215-17	Foerster Sponge Forceps, 24cm, Str, Serr.
2 each	261-02	Mayo Hegar Needle Holder, 18cm, T/C
2 each	259-04	Crile-Wood Needle Holder, 15cm, T/C
1 each	380-13	Cross Action Retractor, Blunt
2 each	308-13	Senn-Miller Retractor, Double Ended, Sharp
1 each	302-02	Crile Retractor, Double Ended
2 each	316-14	Volkman Retractor, 3 Prongs, Blunt
2 each	767-07	Allis Tissue Forceps, 15cm, 4x5T
1 each	235-05	Frazier-Fergusson Suction Tube, 10 Fr.

### PLASTIC SET

Quantity	Cat. Ref.	Description
1 each	61-02	Mayo Operating Scissors, 17cm, Str
1 each	61-05	Mayo Operating Scissors, 17cm, Cur
1 each	65-05	Metzenbaum Scissors, 14cm, Cur
1 each	44-12	Iris Scissors, 14cm, Str, Sh/Sh
1 each	69-14	Ragnell Scissors, 12.5cm, Cur
2 each	129-02	Standard Dressing Forceps, 12.5cm
2 each	128-14	Tissue Forceps, 12.5cm, 1x2T
2 each	139-01	Hudson Dressing Forceps
2 each	139-02	Hudson Tissue Forceps, 1x2T
1 each	139-09	Adson-Brown Tissue Forceps
8 each	162-01	Halstead Mosquito Forceps, 12.5cm, Str
8 each	162-02	Halstead Mosquito Forceps, 12.5cm, Cur
6 each	164-02	Kelly Forceps, Cur
6 each	164-12	Rankin-Crile Forceps, 16cm, Cur
4 each	174-01	Kocher Forceps 5½", Str1x2T
2 each	166-06	Adson Haemostatic Forceps, 19cm, Cur
2 each	183-05	Gemini Forceps, 14cm
12 each	211-04	Backhaus Towel Clamp, 9cm
3 each	211-06	Backhaus Towel Clamp, 13cm
2 each	258-05	Webster Needle Holder, T/C
2 each	259-04	Crile-Wood Needle Holder, 15cm, T/C
1 each	381-06	Janson Retractor
2 each	308-13	Senn-Miller Retractor, Sharp
1 each	308-14	Senn-Miller Retractor, Blunt
1 each	377-05	Parker-Langenbeck Retractor, Set of 2
2 each	321-13	Murphy Retractor, 3 Prongs, Sharp
2 each	321-19	Murphy Retractor, 4 Prongs, Blunt
1 each	383-01	Weitlaner Retractor, 13cm, Blunt
6 each	767-07	Allis Tissue Forceps, 15cm, 4x5T
2 each	769-05	Baby-Babcock Forceps, 14cm
1 each	235-05	Frazier-Fergusson Suction Tube, 10 Fr
2 each	304-18	Joseph Skin Hook, Single
2 each	304-20	Joseph Skin Hook, Double 5 mm



# SURGICAL INSTRUMENT SETS

## GENERAL SURGERY

### PEDIATRIC LAPAROTOMY SET (ADD PLASTIC SET)

Quantity	Cat. Ref.	Description
2 each	130-48	Tissue Forceps, 15cm, 4x5T
2 each	215-14	Foerster Sponge Forceps, 18cm, Serr.
2 each	379-17	Spring Wire Retractor
1 each	316-03	Baby-Farabeuf Retractor
1 each	374-10	Pediatric Retractor
2 each	366-10	Pediatric Deaver Retractor
2 each	347-01	Richardson Retractor
1 each	406-01	Pediatric Balfour Retractor
6 each	767-06	Baby-Allis Tissue Forceps, 14cm, 4x5T

### APPENDECTOMY AND HERINIA SET

Quantity	Cat. Ref.	Description
2 each	20-01	Scalpel Handle No. 3
2 each	20-05	Scalpel Handle No. 4
1 each	61-02	Mayo Operating Scissors, 17cm, Str
1 each	61-05	Mayo Operating Scissors, 17cm, Cur
2 each	70-07	Metzenbaum Scissors, 18cm, Cur
2 each	129-03	Standard Dressing Forceps, 14cm
2 each	128-14	Tissue Forceps, 14cm, 1x2T
1 each	139-01	Hudson Dressing Forceps
2 each	139-02	Hudson Tissue Forceps, 1x2T
2 each	138-19	Russian Tissue Forceps, 20cm
2 each	162-01	Halstead Mosquito Forceps, 12.5cm, Str
12 each	164-09	Rankin-Crile Haemostatic Forceps 16cm Str
6 each	174-04	Kocher-Ochsner Forceps, 20cm, 1x2T, Str
12 each	211-06	Backhaus Towel Clamp, 13cm
3 each	215-16	Foerster Sponge Forceps, 23cm, Str, Serr.
2 each	261-02	Mayo Hegar Needle Holder, 23cm, T/C
1 each	234-01	Pool Suction Tube, Cur
1 each	234-03	Pool Suction Tube, Str
1 each	377-05	Parker-Langenbeck Retractor, Set of 2
1 each	374-16	Retractor
1 each	374-17	Retractor
1 each	375-05	Roux Retractor, Set of 3
2 each	347-04	Richardson Retractor
2 each	348-03	Kelly Retractor 2½" x 2"
1 each	383-01	Weitlaner Retractor, 13cm
9 each	767-07	Allis Tissue Forceps 15cm, 4x5T
2 each	769-06	Babcock Tissue Forceps, 16cm

### COMMON DUCT INSTRUMENTS (ADD LAPAROTOMY SET)

Quantity	Cat. Ref.	Description
2 each	183-11	Gemini Forceps, 28cm
1 each	857-12	Ochsner Gall Duct Probe
1 each	896-25	Bakes Duct Dilator, Set of 9
1 each	860-10	Fergusson Gall Scoop, Large
1 each	860-09	Fergusson Gall Scoop, Medium
1 each	860-08	Fergusson Gall Scoop, Small
2 each	188-08	Lahey Gall Duct Forceps, 23cm
1 each	864-01	Randall Stone Forceps, Fig. 1
1 each	864-02	Randall Stone Forceps, Fig. 2

### COMMON DUCT INSTRUMENTS (cont'd)

1 each	864-03	Randall Stone Forceps, Fig. 3
1 each	864-04	Randall Stone Forceps, Fig. 4

### BOWEL RESECTION SET (ADD BASIC LAPAROTOMY SET)

Quantity	Cat. Ref.	Description
12 each	162-05	Halstead Mosquito Forceps, 12.5cm, Cur
6 each	174-10	Rochester Carmalt Forceps 20cm, Str
3 each	768-05	Williams Tissue Forceps, 16.5cm
2 each	772-03	Allen Intestinal Forceps, 15cm, Str
2 each	773-09	Mayo-Robson Intestinal Forceps, 25cm, Str
2 each	773-02	Doyen Intestinal Forceps, 23cm, Str
2 each	773-05	Doyen Intestinal Forceps, 23cm, Cur
1 each	784-09	Stone Intestinal Clamp
1 each	780-01	Payr-Baby Intestinal Clamp, 14cm
2 each	780-03	Payr Intestinal Clamp, 15cm
2 each	780-07	Payr Intestinal Clamp, 27cm
2 each	780-09	Payr Intestinal Clamp, 33cm
2 each	842-02	De Bakey Tissue Forceps, 20cm

### ABDOMINOPERINEAL RESECTION SET (ADD BASIC LAPAROTOMY SET AND BOWEL RESECTION SET)

Quantity	Cat. Ref.	Description
2 each	61-02	Mayo Operating Scissors, 17cm, Str
2 each	61-05	Mayo Operating Scissors, 17cm, Cur
2 each	61-12	Mayo Operating Scissors, 23cm, Cur
2 each	70-07	Metzenbaum Scissors, 23cm, Cur
1 each	141-09	Mayo-Russian Tissue Forceps, 23cm
2 each	141-07	Nelson-Tissue Forceps, 23cm
10 each	164-11	Rankin-Crile Forceps, 16cm, Str
6 each	164-12	Rankin-Crile Forceps, 16cm, Cur
2 each	168-14	Rochester -Pean Forceps, 20cm, Cur
6 each	174-04	Kocher-Ochsner Forceps, 20cm, Str
3 each	183-11	Gemini Forceps, 28cm
6 each	211-06	Backhaus Towel Forceps, 13cm
2 each	215-17	Foerster Sponge Forceps, 24cm, Str, Serr.
2 each	259-04	Crile-Wood Needle Holder, 15cm, T/C
1 each	264-04	Wangensteen Needle Holder, 26cm, T/C
1 each	322-01	Israel Retractor, 4 Prongs
1 each	322-03	Israel Retractor, 6 Prongs
2 each	316-15	Volkman Retractor, 4 Prongs, Blunt
12 each	767-07	Allis Tissue Forceps, 15cm, 4x5T
8 each	177-10	Schmidt Tonsil Forceps, 19cm





# SURGICAL INSTRUMENT SETS

## GENERAL SURGERY

### THYROIDECTOMY SET (ADD PLASTIC SET)

Quantity	Cat. Ref.	Description
1 each	94-01	Metzenbaum Scissors, 18cm, Str, T/C
1 each	94-07	Metzenbaum Scissors, 18cm, Cur, T/C
2 each	130-48	Tissue Forceps, 15cm, 4x6T
6 each	166-02	Dixon-Lovelace Forceps, 16cm, Str, 1x2T
2 each	326-18	Lahey Retractor
2 each	301-09	Little Retractor, 17cm
2 each	298-17	Cushing Retractor, 23cm
6 each	879-03	Lahey Traction Forceps, 16cm

## GENITO-URINARY SURGERY

### NEPHRECTOMY SET

Quantity	Cat. Ref.	Description
2 each	61-02	Metzenbaum Scissors, 18cm
2 each	187-04	Mixer Forceps, 23cm
6 each	183-06	Mosquito Forceps, 21cm, Cur
6 each	183-09	Gemini Forceps, 23cm
4 each	183-11	Gemini Forceps, 28cm
1 each	244-02	Bozemann Forceps, 26cm, Double Cur
2 each	248-03	Heaney Needle Holder, 21cm
2 each	247-09	Sarot Needle Holder, 26cm
2 each	298-17	Cushing Retractor
1 each	232-11	Ochsner Trocar
1 each	189-06	Gray Gall Duct Forceps, 23cm
2 each	769-08	Babcock Tissue Forceps, 23.5cm
1 each	302-11	Love Retractor, Str
2 each	824-07	Satinsky-DeBaKey Forceps, 24cm
1 each	302-12	Love Retractor, 45°
1 each	864-01	Randall Stone Forceps, Fig. 1
1 each	864-02	Randall Stone Forceps, Fig. 2
1 each	864-03	Randall Stone Forceps, Fig. 3
1 each	864-04	Randall Stone Forceps, Fig. 4
2 each	190-08	Herrick Kidney Pedicle Clamp, 23cm
2 each	191-03	Mayo Guyon Clamp, 23cm

### PYRLOPLASTY AND URETEROPLASTY SET (ADD BASIC LAPAROTOMY SET AND NEPHRECTOMY SET)

Quantity	Cat. Ref.	Description
1 each	44-04	Iris Scissors, 11.5cm, Str
1 each	139-01	Hudson Dressing Forceps
2 each	139-09	Adson-Brown Tissue Forceps
12 each	162-02	Halstead Mosquito Forceps, 12.5cm, Cur
1 each	258-05	Webster Needle Holder, 12cm, T/C
1 each	862-03	Mayo Gall Duct Scoop, 4mm
1 each	862-04	Mayo Gall Duct Scoop, 5mm
1 each	235-05	Frazier (Ferguson) Suction Tube 10 Fr.

### SUPRAPUBIC AND RETROPUBIC PROSTATECTOMY SET (ADD BASIC LAPAROTOMY SET)

Quantity	Cat. Ref.	Description
1 each	61-02	Mayo Operating Scissors, 23cm, Str
1 each	61-05	Mayo Operating Scissors, 23cm, Cur
6 each	168-14	Rochester-Pean Forceps, 20cm, ,Cur
2 each	347-01	Richardson Retractor
2 each	348-03	Kelly Retractor
1 each	415-03	Judd-Masson Retractor
1 each	874-02	Van Buren Sound, Set of 6
2 each	869-02	Young Prostatic Retractor
1 each	871-05	Millin Capsule Holding Forceps, 23cm

### VASECTOMY-MEATOTOMY SET

Quantity	Cat. Ref.	Description
1 each	21-01	Scalpel Handle No.3
1 each	61-02	Mayo Operating Scissors, 15cm, Str
1 each	61-05	Mayo Operating Scissors, 15cm, Cur
1 each	94-01	Metzenbaum Scissors, 18cm, Cur,T/C
1 each	129-03	Standard Dressing Forceps, 14cm
1 each	139-04	Adson Tissue Forceps, 12cm, 1x2T
6 each	162-01	Halstead Mosquito Forceps, 12.5cm, Str
6 each	162-02	Halstead Mosquito Forceps, 12.5cm, Cur
6 each	211-04	Backhaus Towel Forceps, 9cm
1 each	259-04	Crile-Wood Needle Holder, 15cm, T/C
1 each	767-07	Allis Tissue Forceps, 15cm

### TUBOPLASTY SET (ADD BASIC LAPAROTOMY)

Quantity	Cat. Ref.	Description
1 each	21-04	Scalpel Handle No. 7
1 each	44-04	Iris Scissors, 11.5cm, Str
1 each	44-08	Iris Scissors, 11.5cm, Cur
2 each	139-09	Adson-Brown Tissue Forceps, 12cm
2 each	135-01	Potts Smith Dressing Forceps, 18cm, Serr.
8 each	162-02	Halstead Mosquito Forceps, 12.5cm, Cur
1 each	258-05	Webster Needle Holder, 12cm, T/C
2 each	155-07	Jewellers Style Forceps
2 each	303-13	Guthrie Hook, Double
1 each	720-19	Bowmann Probes, Set of 8
2 each	733-05	Castroviejo Forceps
1 each	741-08	McPherson-Vannas Scissors, 8cm, Str
1 each	271-04	Castroviejo Needle Holder, W/Lock
1 each	235-05	Frazier-Ferguson Suction Tube, 10 Fr.
2 each	303-17	Cottle Skin Hook



# SURGICAL INSTRUMENT SETS

## RECTAL SURGERY

### RECTAL INSTRUMENT SET

Quantity	Cat. Ref.	Description
1 each	58-13	Operating Scissors, 14cm, Str, Sh/BI
2 each	58-31	Mayo Operating Scissors, 15cm, Cur
1 each	61-02	Mayo Operating Scissors, 17cm, Str
1 each	61-05	Mayo Operating Scissors, 17cm, Cur
2 each	129-04	Standard Dressing Forceps, 16cm
2 each	129-30	Tissue Forceps, 15cm, 1x2T
8 each	164-09	Rankin-Crile Forceps, 16cm, Str
6 each	168-03	Rochester-Pean Forceps, 16cm, Cur
6 each	175-07	Kocher-Ochsner Forceps, 16cm, Cur, 1x2T
4 each	179-07	Pennington Forceps, 15cm
6 each	211-06	Backhaus Towel Forceps, 13cm
2 each	261-02	Mayo Hegar Needle Holder, 18cm, T/C
2 each	316-04	Volkman Retractor, 4 Prong, Sharp
4 each	767-09	Allis Tissue Forceps, 19cm, 5x6T
1 each	796-07	Sims Rectal Speculum
1 each	798-03	Hirschman Anoscope, Small
1 each	798-04	Hirschman Anoscope, Medium
1 each	798-05	Hirschman Anoscope, Large
1 each	795-01	Czerny Rectal Speculum, 22cm
1 each	803-10	Pratt Rectal Probe, 20cm
1 each	803-14	Rectal Hook, 24cm
1 each	807-10	Buie Suction Tube, 15 Fr.
1 each	805-07	Herget Biopsy Forceps

### PILONIDAL CYST EXCISION SET (ADD RECTAL INSTRUMENT SET)

Quantity	Cat. Ref.	Description
1 each	316-15	Volkman Retractor, 4 Prong, Blunt
1 each	478-17	Spratt Bone Curette, 17cm, Fig. 3

### HEMORRHOIDECTOMY SET

Quantity	Cat. Ref.	Description
1 each	20-01	Scalpel Handle No. 3
1 each	20-05	Scalpel Handle No. 4
1 each	61-02	Mayo Operating Scissors, 17cm, Str
1 each	61-05	Mayo Operating Scissors, 17cm, Cur
2 each	129-03	Standard Dressing Forceps, 14cm
2 each	129-29	Tissue Forceps, 14cm, 1x2T
6 each	162-01	Halstead Mosquito Forceps, 12.5cm, Str
4 each	174-01	Kocher Forceps, 14cm, 1x2T
6 each	168-03	Rochester Pean Forceps, 16cm, Cur
6 each	211-06	Backhaus Towel Forceps, 13cm
2 each	215-17	Foerster Sponge Forceps, 24cm, Str, Serr.
6 each	767-07	Allis Tissue Forceps, 16cm, 4x5T
1 each	798-04	Hirschman Anoscope, Medium
1 each	797-07	Brinkerhoff Rectal Speculum, Medium

## OBSTETRICAL AND GYNECOLOGICAL SURGERY

### DILATATION AND CURETTAGE SET

Quantity	Cat. Ref.	Description
1 each	20-01	Scalpel Handle No.3
1 each	20-06	Scalpel Handle No. 4L
1 each	129-06	Standard Dressing Forceps, 20cm
2 each	164-03	Rankin-Kelly Forceps, 16cm, Str
3 each	164-04	Rankin-Kelly Forceps, 16cm, Cur
4 each	211-06	Backhaus Towel Forceps, 13cm
2 each	215-17	Foerster Sponge Forceps, 24cm, Str, Serr.
2 each	244-02	Bozemann Dressing Forceps, 26cm
1 each	259-04	Crile-Wood Needle Holder, 15cm, T/C
3 each	767-07	Allis Tissue Forceps, 16cm, 4x5T
1 each	920-02	Graves Vaginal Speculum, Medium
1 each	927-01	Auvar Weighted Speculum
1 each	931-09	Jackson Vaginal Retractor
1 each	931-10	Jackson Vaginal Retractor
1 each	931-11	Jackson Vaginal Retractor
1 each	904-14	Hegar Uterine Dilator, Set of 8
1 each	906-03	Goodell Uterine Dilator, 34cm
1 each	900-03	Sims Uterine Sound
2 each	882-01	Schroeder Tenaculum Forceps, 24cm, Str
1 each	885-05	Jacobs Vulsellum Forceps, 21.5cm, Str
1 each	914-02	Thomas Uterine Curette, Fig. 2, Blunt
1 each	914-04	Thomas Uterine Curette, Fig. 4, Blunt
1 each	914-06	Thomas Uterine Curette, Fig. 6, Blunt
1 each	911-37	Sims (Herrera) Uterine Biopsy Curette
1 each	887-02	Kelly Placenta Forceps, 32cm

### BASIC VAGINAL INSTRUMENT SET

Quantity	Cat. Ref.	Description
1 each	20-01	Scalpel Handle No.3
1 each	20-05	Scalpel Handle No.4
1 each	20-06	Scalpel Handle No. 4L
1 each	58-13	Operating Scissors, 14cm, Str, Sh/BI
1 each	61-02	Mayo Operating Scissors, 17cm, Str
1 each	61-05	Mayo Operating Scissors, 17cm, Cur
1 each	70-07	Metzenbaum Scissors, 18cm, Cur
2 each	129-03	Dressing Forceps, 14cm
1 each	129-06	Dressing Forceps, 20cm
2 each	129-29	Tissue Forceps, 14cm, 1x2T
2 each	129-32	Tissue Forceps, 20cm, 1x2T
6 each	164-02	Kelly Forceps, 14cm, Cur
6 each	164-01	Kelly Forceps, 14cm, Str
10 each	168-03	Rochester-Pean Forceps, 16cm, Cur
3 each	172-02	Kocher-Ochsner Forceps, 16cm, Str
8 each	211-06	Backhaus Towel Forceps, 13cm
6 each	215-17	Foerster Sponge Forceps, 24cm, Str, Serr.
1 each	244-02	Bozemann Dressing Forceps, 26cm
1 each	377-05	Parker-Langenbeck Retractor, Set of 2
1 each	364-03	Deaver Retractor
6 each	767-09	Allis Tissue Forceps, 19cm, 5x6T
1 each	927-01	Auvar Weight Speculum
1 each	931-02	Sims Retractor, Medium
3 each	882-01	Schroeder Tenaculum Forceps, 24cm
1 each	882-04	Sken Vulsellum Forceps, 24cm, Cur



# SURGICAL INSTRUMENT SETS

## OBSTETRICAL AND GYNECOLOGICAL SURGERY

### ABDOMINAL GYNECOLOGICAL SET (ADD BASIC LAPAROTOMY SET)

Quantity	Cat. Ref.	Description
1 each	20-06	Scalpel Handle No. 4L
1 each	61-05	Mayo Operating Scissors, 23cm, Cur
1 each	128-21	Tissue Forceps, 30cm, 1x2T
8 each	174-04	Kocher-Ochsner Forceps, 20cm, Str
3 each	215-16	Foerster Sponge Forceps, 23cm, Str, Serr.
2 each	248-03	Heaney Needle Holder, 20cm
1 each	409-13	O'Sullivan-O'Connor Retractor
6 each	767-09	Allis Tissue Forceps, 19cm, 5x6T
1 each	920-02	Graves Vaginal Speculum, Medium
2 each	882-01	Schroeder Tenaculum Forceps, 24cm
1 each	882-04	Sken Vulsellum Forceps, 24cm, Cur
2 each	885-06	Jacobs Vulsellum Forceps, Cur
2 each	885-05	Jacobs Vulsellum Forceps, Str
2 each	192-02	Heaney Hysterectomy Forceps, 21cm
2 each	193-03	Heaney-Ballantine Hysterectomy Forceps

### LAPAROSCOPY SET

Quantity	Cat. Ref.	Description
1 each	20-01	Scalpel Handle No. 3
1 each	61-02	Mayo Operating Scissors, 17cm, Str
1 each	139-02	Hudson Tissue Forceps, 1x2T
2 each	165-04	Coller Forceps, 16cm, Cur
12 each	211-06	Backhaus Towel Forceps, 13cm
2 each	215-16	Foerster Sponge Forceps, 23cm, Str, Serr.
1 each	243-03	Crile-Wood Needle Holder, 18cm
2 each	767-07	Allis Tissue Forceps, 16cm, 4x5T
1 each	920-02	Graves Vaginal Speculum, Medium
1 each	927-01	Auvar Weight Speculum
1 each	900-10	Simpson Uterine Sound
2 each	882-01	Schroeder Tenaculum Forceps, 24cm
2 each	878-04	Barrett Tenaculum Forceps, 19cm

### BARTHOLIN CYST EXCISION SET

Quantity	Cat. Ref.	Description
1 each	20-01	Scalpel Handle No. 3
1 each	61-02	Mayo Operating Scissors, 17cm, Str
1 each	61-05	Mayo Operating Scissors, 17cm, Cur
1 each	70-07	Metzenbaum Scissors, 18cm, Cur
1 each	129-03	Dressing Forceps, 14cm
1 each	128-16	Tissue Forceps, 14cm, 1x2T
3 each	162-05	Halstead Mosquito Forceps, 12.5cm, Cur
3 each	168-03	Rochester Pean Forceps, 16cm, Cur
6 each	211-6	Backhaus Towel Forceps, 13cm
2 each	215-17	Foerster Sponge Forceps, 24cm, Str, Serr.
1 each	261-02	Mayo Hegar Needle Holder, 18cm, T/C
6 each	767-09	Allis Tissue Forceps, 19cm, 5x6T
1 each	927-01	Auvar Weight Speculum
1 each	931-02	Sims Vaginal Speculum, Double Ended

### VAGINAL TUBAL LIGATION SET

Quantity	Cat. Ref.	Description
1 each	20-05	Scalpel Handle No. 4
1 each	20-06	Scalpel Handle No. 4L
1 each	61-02	Mayo Operating Scissors, 17cm, Str
1 each	91-03	Mayo Operating Scissors, 23cm, Str, T/C
1 each	91-06	Mayo Operating Scissors, 23cm, Cur, T/C
1 each	70-07	Metzenbaum Scissors, 18cm, Cur
1 each	128-16	Tissue Forceps, 14cm, 1x2T
2 each	138-20	Russian Tissue Forceps, 25cm
6 each	164-02	Kelly Forceps, 14cm, Cur
6 each	164-04	Rankin-Kelly Forceps, 16cm, Cur
2 each	168-14	Rochester-Pean Forceps, 20cm, Cur
2 each	183-11	Gemini Forceps, 28cm
6 each	211-06	Backhaus Towel Forceps, 13cm
3 each	215-17	Foerster Sponge Forceps, 24cm, Str, Serr.
2 each	248-03	Heaney Needle Holder, 20cm
1 each	364-04	Deaver Retractor
4 each	767-07	Allis Tissue Forceps, 15cm, 4x5T
2 each	767-09	Allis Tissue Forceps, 19cm, 5x6T
2 each	769-07	Babcock Tissue Forceps, 20cm
1 each	920-02	Graves Vaginal Speculum, Medium
1 each	927-01	Auvar Weight Speculum
1 each	900-10	Simpson Uterine Sound
2 each	882-01	Schroeder Tenaculum Forceps, 24cm
2 each	192-02	Heaney Hysterectomy Forceps, 21cm

## NEUROSURGERY

### BASIC CRANIOTOMY SET

Quantity	Cat. Ref.	Description
1 each	20-01	Scalpel Handle No. 3
1 each	20-05	Scalpel Handle No. 4
1 each	21-04	Scalpel Handle No. 7
1 each	61-02	Mayo Operating Scissors, 17cm, Cur
1 each	61-05	Mayo Operating Scissors, 17cm, Str
1 each	94-01	Metzenbaum Scissors, 18cm, Str, T/C
1 each	94-07	Metzenbaum Scissors, 18cm, Cur, T/C
1 each	72-03	Potts-Smith Scissors, 19cm, 25°
1 each	48-09	Kelly Scissors, 16cm
2 each	133-27	Semken Tissue Forceps, 15cm, 1x2T
2 each	139-03	Adson Dressing Forceps, 12cm, Serr.
2 each	139-04	Adson Dressing Forceps, 12cm, 1x2T
2 each	135-15	Cushing Tissue Forceps, 18cm, 1x2T
3 each	136-05	Taylor Bayonet Forceps, 18cm, Serr.
18 each	162-01	Halstead Mosquito Forceps, 12.5cm, Str
18 each	162-05	Halstead Mosquito Forceps, 12.5cm, Cur
24 each	162-18	Dandy Forceps, 14cm
6 each	174-02	Kocher-Ochsner Forceps, 16cm, Str
6 each	174-03	Kocher-Ochsner Forceps, 17cm, Str
3 each	166-03	Adson Forceps, 18.5cm, Str
3 each	166-04	Adson Forceps, 18.5cm, Cur
18 each	211-04	Backhaus Towel Forceps, 9cm
12 each	211-06	Backhaus Towel Forceps, 13cm



# SURGICAL INSTRUMENT SETS

## NEUROSURGERY

### BASIC CRANIOTOMY SET (cont'd)

Quantity	Cat. Ref.	Description
6 each	215-17	Foerster Sponge Forceps, 24cm, Str, Serr.
4 each	259-04	Crile-Wood Needle Holder, 15cm, T/C
1 each	292-01	Michel Clip Applying Forceps
1 each	55-11	Wire Cutting Scissors, 12.5cm
1 each	381-06	Jansen Retractor, 11cm, Blunt
1 each	381-05	Wagner-Jansen Retractor, 12.5cm, Sharp
2 each	308-13	Senn-Miller Retractor, Double Ended, Sharp
2 each	321-19	Murphy Retractor, 19cm, 4 Prong, Sharp
2 each	390-01	Beckmann Retractor, 31cm, Sharp
1 each	384-05	Anderson-Adson Retractor, 20cm, Sharp
2 each	767-07	Allis Tissue Forceps, 15cm
1 each	627-15	Freer Elevator, 18cm, Double Ended
2 each	235-04	Frazier-Fergusson Suction Tube, 8 Fr.
2 each	235-05	Frazier-Fergusson Suction Tube, 10 Fr.
1 each	498-03	Zaufal-Jansen Bone Rongeur, 18cm
1 each	302-11	Love Retractor, 21.5cm, Str
1 each	501-02	Stille-Luer Bone Rongeur, 23cm, Angled
1 each	540-09	Hudson Hand Drill
2 each	754-15	Gigli Wire Saw Handle
2 each	754-11	Gigli Wire Saw, 50cm
1 each	755-01	Martel Gigli Saw Guide, 30cm
1 each	492-10	Luer Bone Rongeur, 18cm, Str
1 each	661-04	Schlesinger Rongeur, 15cm, 3mm Upwards
1 each	656-13	Ferris-Smith-Kerrison Rongeur, 18cm, 5mm
1 each	656-15	Ferris-Smith-Kerrison Rongeur, 18cm, 3mm
1 each	663-13	Cushing Pituitary Rongeur
1 each	763-06	Cushing Spoon, 17cm
1 each	757-01	Frazier Dura Dissector, 15cm
2 each	759-04	Frazier Dura Hook, 13cm, Sharp
1 each	759-08	Adson Dura Hook, 20cm
1 each	759-16	Dandy Hook, 21cm, Str
1 each	302-12	Love Retractor, 19cm, 45°
1 each	302-13	Love Retractor, 19cm, 90°
1 each	463-07	Lagenbeck Periosteal Elevator, 17cm
1 each	461-07	Adson Periosteal Elevator, 17cm
1 each	152-23	Adson Hypophyseal Bayonet Forceps 21.5cm

### VENTRICULOGRAPHY SET

Quantity	Cat. Ref.	Description
2 each	20-01	Scalpel Handle No. 3
1 each	61-02	Mayo Operating Scissors, 17cm, Str
1 each	61-05	Mayo Operating Scissors, 17cm, Cur
1 each	70-07	Metzenbaum Scissors, 18cm, Cur
1 each	48-09	Kelly Scissors, 16cm, Str
1 each	133-27	Semken Tissue Forceps, 15cm, 1x2T
1 each	135-15	Cushing Tissue Forceps, 18cm, 1x2T
1 each	135-04	Cushing Tissue Forceps, 18cm, Serr.
6 each	162-18	Dandy Forceps, 14cm
6 each	211-04	Backhaus Towel Forceps, 9cm
4 each	211-06	Backhaus Towel Forceps, 13cm
4 each	215-17	Foerster Sponge Forceps, 24cm, Str, Serr.
1 each	259-04	Crile-Wood Needle Holder, 15cm, T/C
1 each	381-06	Jansen Retractor, 11cm, Blunt
1 each	381-05	Wagner-Jansen Retractor, 12.5cm, Sharp
1 each	308-13	Senn-Miller Retractor, Double Ended, Sharp
1 each	235-05	Frazier-Fergusson Suction Tube, 10 Fr.

### VENTRICULOGRAPHY SET (cont'd)

Quantity	Cat. Ref.	Description
1 each	478-12	Spratt Bone Curette, 17cm, Fig. 000
1 each	478-14	Spratt Bone Curette, 17cm, Fig. 0
1 each	540-09	Hudson Hand Drill
1 each	759-04	Frazier Dura Hook, 12.5cm, Sharp
1 each	461-08	Adson Periosteal Elevator, 17cm, Cur

### NEUROSURGICAL-LAMINECTOMY SET

Quantity	Cat. Ref.	Description
2 each	72-02	Potts-smith Scissors, 19cm, 45°
1 each	75-08	Strully Scissors, 20cm, With Probe Tips
2 each	139-03	Adson Dressing Forceps, 12cm, Serr.
2 each	139-04	Adson Tissue Forceps, 12cm, 1x2T
2 each	135-04	Cushing Dressing Forceps, 21cm, Bayonet
2 each	135-15	Cushing Tissue Forceps, 21cm, Bayonet
4 each	166-03	Adson Forceps, 21cm, Str
4 each	166-04	Adson Forceps, 21cm, Cur
6 each	215-17	Foerster Sponge Forceps, 23cm, Str, Serr.
2 each	261-14	Julian Needle Holder 20cm, T/C
1 each	754-03	McKenzie Clip Applying Forceps, 15cm
2 each	397-03	Gelpi Retractor, 18cm
1 each	526-03	Tuffier Retractor, 16.5cm
1 each	391-02	Beckmann-Adson Retractor, 31cm
1 each	478-11	Spratt Bone Curette, 17cm, Fig. 0000
1 each	478-13	Spratt Bone Curette, 17cm, Fig. 00
1 each	478-14	Spratt Bone Curette, 17cm, Fig. 0
1 each	302-11	Love Retractor, 19cm, Str
2 each	842-01	De Bakey Tissue Forceps, 16cm
1 each	540-06	Hudson Hand Drill
2 each	466-04	Taylor Bone Lever
2 each	466-05	Taylor Bone Lever
2 each	663-33	Spurling Rongeur, 15cm, Shaft, Upward
2 each	663-30	Spurling Rongeur, 15cm, Shaft, Str
2 each	655-18	Ferris-Smith-Kerrison Rongeur, 18 Shaft
2 each	663-20	Love-Gruenwald Rongeur, 12cm Shaft, Str
2 each	663-23	Love-Gruenwald Rongeur, 12cm Shaft
2 each	663-25	Love-Gruenwald Rongeur, 18cm Shaft
2 each	763-06	Cushing Spoon, 17cm
2 each	759-16	Dandy Nerve Hook, 21cm, Str
2 each	760-01	Smithwick Hook, 30cm, Double Ended
2 each	764-01	Scoville Nerve Root Retractor, Str
2 each	764-02	Scoville Nerve Root Retractor, Angular
1 each	461-08	Adson Periosteal Elevator, Cur
1 each	758-03	Penfield Dissector, Double Ended
1 each	390-02	Beckmann-Eaton Retractor, 32cm
1 each	436-19	Hoke Osteotome, 14cm
1 each	436-20	Hoke Osteotome, 14cm
1 each	436-21	Hoke Osteotome, 14cm
1 each	436-22	Hoke Osteotome, 14cm



# SURGICAL INSTRUMENT SETS

## NEUROSURGERY

### SKULL TRACTION SET

Quantity	Cat. Ref.	Description
1 each	61-02	Mayo Operating Scissors, 17cm, Str
1 each	128-16	Tissue Forceps, 15cm, 1x2T
2 each	162-01	Halstead Mosquito Forceps, 12.5cm, Str
2 each	162-05	Halstead Mosquito Forceps, 12.5cm, Cur
8 each	211-04	Backhaus Towel Forceps, 9cm
2 each	215-17	Foerster Sponge Forceps, 23, Str, Serr.
1 each	538-13	Stille Pattern Cranial Drill
1 each	755-06	Crutchfield Skull Tracing Tong

## ORTHOPEDIC SURGERY

### BASIC MAJOR ORTHOPEDIC SET

Quantity	Cat. Ref.	Description
1 each	20-01	Scalpel Handle No.3
2 each	20-05	Scalpel Handle No.4
2 each	61-01	Mayo Operating Scissors, 15cm, Str
2 each	61-04	Mayo Operating Scissors, 15cm, Cur
1 each	61-02	Mayo Operating Scissors, 17cm, Str
1 each	61-05	Mayo Operating Scissors, 17cm, Cur
1 each	70-07	Metzenbaum Scissors, 18cm, Cur
1 each	105-04	Lister Bandage Scissors, 20cm
2 each	128-16	Tissue Forceps, 15cm, 1x2T
2 each	130-51	Tissue Forceps, 15cm, 4x5T
2 each	139-03	Hudson Tissue Forceps, 12cm, 1x2T
10 each	164-09	Rankin-Crile Forceps, 16cm, Cur
6 each	174-04	Kocher-Ochsner Forceps, 20cm, Cur
10 each	211-06	Backhaus Towel Forceps, 13cm
2 each	261-03	Mayo Hegar Needle Holder, 15cm, T/C
2 each	259-04	Crile-Wood Needle Holder, 15cm, T/C
1 each	377-05	Parker-Langenbeck Retractor
2 each	339-01	Meyerdig Retractor, 21cm
2 each	339-02	Meyerdig Retractor, 23cm
2 each	322-01	Israel Retractor, 23cm, 4 Prong, Blunt
2 each	316-04	Volkman Retractor
2 each	316-15	Volkman Retractor
2 each	469-07	Benett Bone Lever
2 each	469-09	Benett Bone Lever
2 each	336-01	Hibbs Retractor, 24cm
1 each	390-01	Beckmann Retractor, 31cm
6 each	767-07	Allis Tissue Forceps, 15cm, 4x5T
1 each	235-04	Frazier-Fergusson Suction Tube, 10 Fr.
1 each	235-06	Frazier-Fergusson Suction Tube, 12 Fr.
1 each	498-02	Beyer Rongeur, 18cm, Cur
2 each	177-09	Schmidt Tonsil Forceps, 19cm
1 each	487-09	Ruskin-Liston Bone Cutting Forceps, 19cm
1 each	501-06	Stille-Luer Rongeur, 23cm, Cur
1 each	508-08	Kern-Lane Bone Holding Forceps, 27cm
1 each	511-02	Lambotte Bone Holding Forceps, 27cm
1 each	519-03	Lane Bone Holding Forceps, 33cm
1 each	516-04	Lowmann Bone Clamp, 18cm
1 each	516-05	Lowmann Bone Clamp, 20cm
2 each	316-01	Volkman Retractor, 22cm, Sharp
1 each	436-01	Hibbs Osteotome, 24cm, Str
1 each	436-02	Hibbs Osteotome, 24cm, Str

### BASIC MAJOR ORTHOPEDIC SET (cont'd)

Quantity	Cat. Ref.	Description
1 each	436-03	Hibbs Osteotome, 24cm, Str
1 each	436-04	Hibbs Osteotome, 24cm, Str
1 each	437-06	Hibbs Gouge, 24cm, str
1 each	437-07	Hibbs Gouge, 24cm, str
1 each	437-08	Hibbs Gouge, 24cm, str
1 each	437-02	Hibbs Osteotome, 24cm, Cur
1 each	437-03	Hibbs Osteotome, 24cm, Cur
1 each	437-04	Hibbs Osteotome, 24cm, Cur
1 each	437-11	Hibbs Gouge, 24cm, Cur
1 each	437-12	Hibbs Gouge, 24cm, Cur
1 each	437-13	Hibbs Gouge, 24cm, Cur
1 each	423-04	Mallet, 26.5cm, 510g
1 each	458-17	Key Elevator, 19cm
1 each	458-18	Key Elevator, 19cm
1 each	458-19	Key Elevator, 19cm

## THORACIC AND CARDIAC SURGERY

### MAJOR CARDIOVASCULAR SET (ADD BASIC LAPAROTOMY SET)

Quantity	Cat. Ref.	Description
1 each	234-05	Yankauer Suction Tube
1 each	20-04	Scalpel Handle No. 3L
1 each	96-04	Metzenbaum Scissors, 18cm, Cur, T/C, S/S
1 each	94-09	Metzenbaum Scissors, 18cm, Cur, T/C, B/B
1 each	72-03	Potts-Smith Scissors, 19cm, 25°
1 each	72-02	Potts-Smith Scissors, 19cm, 45°
1 each	72-01	Potts-Smith Scissors, 19cm, 60°
1 each	72-03	Potts-Smith Scissors, 19cm, 25°, Delicate
2 each	159-13	Potts-Smith Dressing Forceps, 24cm, T/C
2 each	141-08	Nelson Tissue Forceps, 23cm, 5x6T
24 each	163-13	Providence Hospital Forceps, 14cm, Cur
18 each	164-06	Crile Forceps, 14cm, Cur
6 each	168-14	Rochester-Pean Forceps, 18cm, Cur
18 each	211-04	Backhaus Towel Forceps, 9cm
2 each	260-17	De Bakey Needle Holder, 23cm, T/C
2 each	301-19	Little Retractor, 17cm
1 each	298-17	Cushing Retractor, 23cm
1 each	374-16	Retractor, 30cm
4 each	374-17	Retractor, 40cm
2 each	364-03	Deaver Retractor
1 each	347-01	Richardson Retractor, Small
1 each	347-02	Richardson Retractor, Medium
1 each	348-02	Kelly Retractor
1 each	348-03	Kelly Retractor
1 each	343-02	Harrington Retractor, 30cm
1 each	343-01	Harrington Retractor, 30cm
2 each	316-04	Volkman Retractor 4 Prong, Sharp
1 each	627-15	Freer Elevator, 18cm, Double Ended
1 each	235-05	Frazier Suction Tube, 10 Fr
2 each	842-01	De Bakey Tissue Forceps, 16cm
2 each	842-03	De Bakey Tissue Forceps, 24cm
2 each	808-03	Glover Atrauma Bulldog Clamp, 9cm, Str



# SURGICAL INSTRUMENT SETS

## THORACIC AND CARDIAC SURGERY

### MAJOR CARDIOVASCULAR SET (cont'd) (ADD BASIC LAPAROTOMY SET)

Quantity	Cat. Ref.	Description
2 each	808-07	Glover Atrauma Bulldog Clamp, 9cm, Cur
1 each	816-01	De Bakey-Semb Atrauma Forceps
2 each	814-03	De Bakey Atrauma Forceps, 31cm
2 each	819-02	De Bakey Atrauma Forceps, 21cm
2 each	819-03	De Bakey Atrauma Forceps, 25cm
1 each	824-04	De Bakey Atrauma Forceps, 26.5cm
2 each	182-08	Rumel Dissecting Forceps, 23cm
2 each	182-09	Rumel Dissecting Forceps, 23cm

### CATARACT SURGEY SET (cont'd) (ADD BASIC EYE SET)

Quantity	Cat. Ref.	Description
1 each	730-10	Castroviejo Capsular Forceps, 10cm
1 each	741-15	Westcott Scissors, 11cm
1 each	742-03	Castroviejo Corneal Scissors, 11cm
1 each	742-02	Castroviejo Corneal Scissors, 11cm
1 each	268-11	Castroviejo Needle Holder, 14cm, Str

## OPHTHALMIC SURGERY

### BASIC EYE SET

Quantity	Cat. Ref.	Description
1 each	20-01	Scalpel Handle No. 3
1 each	21-04	Scalpel Handle No. 7
1 each	44-04	Iris Scissors, 11cm, Str
1 each	44-08	Iris Scissors, 11cm, Cur
4 each	162-01	Halsted Mosquito Forceps, 12.5cm, Str
6 each	162-05	Halsted Mosquito Forceps, 12.5cm, Cur
10 each	211-04	Backhaus Towel Forceps, 9cm
1 each	294-06	O'Brien Suture Scissors, 9cm
1 each	702-19	Lancaster Eye Speculum
1 each	702-15	Weiss Eye Speculum
1 each	704-12	Desmarres Lid Retractor
1 each	725-18	Graefe Iris Forceps, 10cm, Str
1 each	725-20	Graefe Iris Forceps, 10cm, Cur
1 each	725-24	Graefe Iris Forceps, 10cm, Str, 1x2T
1 each	725-26	Graefe Iris Forceps, 10cm, Cur, 1x2T
1 each	728-18	Graefe Fixation Forceps, 11cm
1 each	730-12	Arruga Capsuler Forceps, 10cm
1 each	45-10	Stevens Scissors, 11.5cm, Cur
1 each	742-03	Castroviejo Corneal Scissors, 11cm
1 each	742-02	Castroviejo Corneal Scissors, 11cm
1 each	268-11	Castroviejo Needle Holder, 14cm, Str

### CATARACT SURGEY SET (ADD BASIC EYE SET)

Quantity	Cat. Ref.	Description
1 each	703-14	Park Eye Speculum
1 each	24-02	Troutman Blade Breaker
1 each	712-06	Graefe Hook, 14cm
1 each	715-05	Lewis Lens Scoop, 14cm
1 each	714-04	Wecker Iris Spatula, 13cm
1 each	716-11	Kirby Hook and Expressor, 14cm
1 each	727-10	Barraquer-Katzin Iris Forceps, 7cm
1 each	729-04	O'Brien Fixation Forceps, 11cm, 1x2T
1 each	727-15	Castroviejo Iris Forceps, 9cm, Str
1 each	727-16	Castroviejo Iris Forceps, 9cm, Cur

## EAR, NOSE AND THROAT SURGERY

### BASIC EAR SET

Quantity	Cat. Ref.	Description
2 each	20-01	Scalpel Handle No. 3
1 each	61-05	Mayo Operating Scissors, 17cm, Cur
1 each	95-01	Metzenbaum Scissors, 14cm, Cur, T/C
1 each	94-09	Metzenbaum Scissors, 18cm, Cur, T/C
1 each	46-09	Scissors, 11.5cm, Str
1 each	46-10	Scissors, 11.5cm, Cur
1 each	139-04	Adson Tissue Forceps, 12cm, 1x2T
6 each	162-01	Halstead Mosquito Forceps, 12.5cm, Str
2 each	164-01	Kelly Forceps, 14cm, Str
8 each	211-04	Backhaus Towel Forceps, 9cm
1 each	258-04	Halsey Needle Holder, 12.5cm, T/C
1 each	55-11	Wire Cutting Scissors, 12.5cm
1 each	381-06	Jansen Retractor, 11cm, Blunt
1 each	380-16	Allport Retractor, 11cm, Sharp
2 each	308-13	Senn-Miller Retractor, Double Ended, Sharp
1 each	327-11	Langenbeck Retractor, 30x11mm
1 each	327-12	Langenbeck Retractor, 30x14mm
2 each	767-07	Allis Tissue Forceps, 15cm, 4x5T
1 each	728-18	Graefe Fixation Forceps
1 each	627-15	Freer Elevator, 18cm, Double Ended
1 each	681-15	Zoellner Ear Speculum, 5.5x6.5mm
1 each	681-16	Zoellner Ear Speculum, 6.5x7.5mm
1 each	681-17	Zoellner Ear Speculum, 7.5x8.5mm
1 each	681-18	Zoellner Ear Speculum, 8.5x9.5mm
1 each	696-09	Buck Ear Curette, Fig. 00, Str, Sharp
1 each	696-11	Buck Ear Curette, Fig. 1, Str, Sharp
1 each	142-02	Lucae Ear Forceps, 14cm
1 each	235-04	Frazier (Ferguson) Suction Tube, 8 Fr.
1 each	235-05	Frazier (Ferguson) Suction Tube, 10 Fr.
1 each	381-10	Henner (Lempert) Retractor, 12cm
2 each	304-18	Joseph Skin Hook, Single



# SURGICAL INSTRUMENT SETS

## EAR, NOSE AND THROAT SURGERY

### BASIC NASAL SET

Quantity	Cat. Ref.	Description
1 each	234-05	Yankauer Suction Tube
1 each	20-01	Scalpel Hndle No. 3
1 each	21-04	Scalpel Hndle No. 7
1 each	61-02	Mayo Operating Scissors, 17cm, Cur
2 each	44-14	Iris Scissors, 11.5cm, Cur
1 each	65-05	Metzenbaum Scissors, 14cm, Cur
2 each	70-07	Metzenbaum Scissors, 18cm, Cur
2 each	139-04	Adson Tissue Forceps, 12cm, 1x2T
6 each	162-01	Halstead Mosquito Forceps, 12.5cm, Str
6 each	162-02	Halstead Mosquito Forceps, 12.5cm, Cur
6 each	211-04	Backhaus Towel Forceps, 9cm
1 each	258-04	Halsey Needle Holder, 12.5cm, T/C
1 each	381-06	Jansen Retractor, 11cm
1 each	386-06	Allport Retractor, 10.5cm
1 each	308-13	Senn-Miller Retractor, Double Ended, Sharp
1 each	308-14	Senn-Miller Retractor, Double Ended, Blunt
1 each	377-05	Parker-Langenbeck Retractor
2 each	767-07	Allis Tissue Forceps, 15cm, 4x5T
1 each	728-18	Graefe Forceps
2 each	235-04	Frazier (Fergusson) Suction Tube, 8 Fr.
1 each	422-01	Mallet, 18.5cm, 200g
1 each	614-02	Viena Nasal Speculum, Fig. 2
1 each	615-12	Killian Nasal Speculum, 90mm
1 each	615-13	Cottle Nasal Speculum, 50 mm
1 each	143-04	Troeltsch (Wilde) Dressing Forceps, 17cm
2 each	304-18	Joseph Skin Hook, Single
2 each	304-19	Joseph Skin Hook, Double, 2mm
2 each	304-21	Joseph Skin Hook, Double, 7mm

### MINOR NASAL SET

Quantity	Cat. Ref.	Description
1 each	234-05	Yankauer Suction Tube
1 each	655-27	Kerrison Rongeur, 4x3mm
1 each	422-01	Mallet, 18.5cm, 200g
1 each	614-02	Viena Nasal Speculum, Fig. 2
1 each	615-12	Killian Nasal Speculum, 90mm
1 each	615-13	Cottle Nasal Speculum, 50mm
1 each	620-10	Noyes Polypus Forceps, 16.5cm
1 each	622-04	Takahashi Polypus Forceps, 19cm, 2x10mm
1 each	642-03	Ash Forceps, 22cm

### MAJOR NASAL SET (ADD BASIC NASAL SET)

Quantity	Cat. Ref.	Description
1 each	44-04	Iris Scissors, 11cm, Str
1 each	46-09	Scissors, 11cm, Str
1 each	46-10	Scissors, 11cm, Cur
2 each	142-06	Gruenwald (Jansen) Dressing Forceps, 16cm
1 each	259-04	Crile-Wood Needle Holder, 15cm, T/C
1 each	299-13	Cottle Retractor
1 each	627-15	Freer Elevator, 18cm, Double Ended
1 each	619-01	Hartmann Nasal Polypus Forceps, 16cm
1 each	618-06	Jackson Nasal Scissors, 22cm
1 each	627-01	Ballenger Septum Knife, 3mm, Str
1 each	625-06	Converse Septum Knife
1 each	625-04	Fomon Knife, 16cm, Double Ended, Cur
1 each	625-01	Cottle Nasal Knife, 15cm
1 each	628-05	Joseph Elevator, 16cm, Cur
1 each	304-15	Gillies Hook, 18cm
1 each	303-16	Cottle Double Hook, 16cm
1 each	637-07	Fomon Retractor, Ball End Prongs
1 each	637-03	Cottle Retractor, 14cm
1 each	304-18	Joseph Skin Hook, Single
2 each	304-20	Joseph Skin Hook, Double, 5mm
1 each	637-13	Masing Retractor, 20cm, Double Ended
1 each	438-02	Sheehan Osteotome, 16cm, 4mm
1 each	438-04	Sheehan Osteotome, 16cm, 8mm
1 each	438-05	Sheehan Osteotome, 16cm, 10mm
1 each	438-06	Sheehan Osteotome, 16cm, 12mm
1 each	634-3	Cottle Septum Chisel, 4mm, Cur
1 each	644-04	Cottle Forceps, 11cm
1 each	646-03	Fomon Nasal Scissors, 12.5cm, Cur
1 each	646-01	Fomon Nasal Scissors, 13cm, Angular



# INHALTSVERZEICHNIS INDEX INDEX

	Page		Page
<b>A</b>			
Abadie Intestinal and Stomach Clamp Forceps	783	Adson-Baby Retractor	385
Abadie Ophthalmic Curettes	710	Adson-Brown Tissue Forceps	139, 140
Abdominal Retractors	404-414	Adson-Brown Tissue Forceps with T/C	158
" Badgley	407	Adson-Graefe Tissue Forceps	140
" Balfour	406, 407	Aebli Ophthalmic Micro Scissors	739
" Balfour-Baby	406	Aesthesiometers	11
" Center Blade for Balfour	407	" Aly	11
" Cherry	407	" Wartenberg	11
" Denis-Browne	412	" Weber	11
" Doyen	414	Agricola Eye Speculum	703
" Franz	411	Agricola Retractor	379
" Frazier	410	Alabama-University Ophthalmic Suture Forceps	732
" Gosset	408	Albarran Reverdin Needles	277
" Hertzler	406	Albarran Retractor	357
" Houzal	404	Alderdyce Tonsil Elevators	592
" Kirschner	410	Alderdyce Elevators	463
" Kirschner (Semm)	412	Alexander Bone Chisels	439
" Oettingen	404	Alexander Bone Gouges	439
" O-Sullivan-O'Conner	409	Alexander Bone Rongeurs	493
" Perman	405	Alexander Raspatories	455
" Quervain	405	Alexander Sterilizing Jars	978
" Robin-Masse	404	Alexander Tonsil Needles	594
" Rochard	414	Alexander Uterine Biopsy Forceps	891
" Scoville-Richter	409	Allen Intestinal Clamp Forceps	772
" Temple Fay	410	Allen-Kocher Haemostatic Forceps	170
" Ulrich-St. Gallen	409	Allis Atrauma Tissue and Organ Holding Forceps	770
Abel Uterine Tenaculum Forceps	881	Allis Lung Grasping Forceps	537
Abortion Scoops	952	Allis Tissue and Organ Holding Forceps	767
Abraham Tonsil Knives	587, 588	Allis-Adair Tissue and Organ Holding Forceps	767
Abscess Knives	34	Allis-Babcock Tissue and Organ Holding Forceps	769
" Dieffenbach	34	Allis-Baby Tissue and Organ Holding Forceps	767
" Sven Hanssen	34	Allis-Niro Tissue and Organ Holding Forceps	768
" Vaughan	34	Allison Retractor	370
Accessories for Stethoscopes	9	Allison Spatulas	370
Adair Uterine Tenaculum Forceps	878	Allport Hooklets	698
Adams Operating Scalpel	32	Allport Retractor	380
Adenoid Curettes	648-652	Alm Retractor	380
" Barnhill	651	Alu Tuning Forks	685, 687
" Ingersoll	649	Alvis Ophthalmic Curettes	710
" La Force	650	Aly Aesthesiometer	11
" La Force-Stevenson	650	Amann Gauze Packers	901
" Meddleton	649	Amenabar Lid Expressor	704
" Moure	651	Amenabar Ophthalmic Lens Expressor	715
" Shambaugh	650	Amputation Knives	41, 42
" Shambaugh (Negus)	652	" Catlin	41
" St. Clair-Thomson	649	" Collin	41, 42
" Stubbs	651	" Langenbeck	42
" Vogel	649	" Liston	41
Adlerkreutz Tissue Forceps	136	" Simon	42
Adson Bone Rongeurs	496	Amputation Saws	116-119
Adson Dressing Forceps	139, 140	" Barker	117
Adson Dressing Forceps with T/C	158	" Bier	118
Adson Dura Hooks	759	" Bruns	119
Adson Elevators	461	" Butcher	117
Adson Haemostatic Forceps	166	" Charriere	116
Adson Hypophyseal Forceps	152	" Collin	117
Adson Instrument for Cranial Opening	755	" Detachable	116
Adson Needle Holders	243	" Gigli	119
Adson Raspatories	457	" Helferich-Bier	118
Adson Reamer Forceps	540	" Hinged Back	116
Adson Retractor	305, 386, 387, 389, 390	" Lindemann	119
Adson Suction Tubes	235	" Olivecrona	119
Adson Tissue Forceps	139, 140	" Rust	118
Adson Tissue Forceps with T/C	158	" Satterlee	116
		" Weiss	116



	Page		Page
Anaesthesia Masks	15	" Cooley	832-835
" Baby-Esmarch	15	" Cooley-Glassman	836
" Esmarch	15	" Dale	830
" Julliard	15	" Dardik	831
" Schimmelbusch	15	" De Bakey	811-819
" Yankauer	15	" De Bakey-Beck	820
Anal Retractors	797, 798	" De Bakey-Harken	827
Anatomy Knives	36-40	" De Bakey-McQuigg-Mixer	818
Anderson Obstetrical Forceps	962	" De Bakey-Mixer	817
Anderson-Adson Retractor	384	" De Bakey-Rumel	817
Anderson-Critchett Ophthalmic Knives	709	" De Bakey-Semb	816
Anderson-Neivert Rhinoplastic Chisel	636	" Derra	830
Andrew Tongue Depressors	571	" Derra-Cooley	832
Andrews-Pynchon Suction Tubes	234	" Dick	837
Anestophon Stethoscope	8	" Dietrich	829
Angiotribes Buie	180	" Glover	821
Angiotribes Fergusson	180	" Glover-De Bakey	825
Angle Wire Cutting Pliers	552	" Gregory	829
Ankeney Rib Spreaders	533	" Henly	830
Anoscopes	798, 799	" Lambert-Kay	825
Antoli-Candela Ear Curettes	697	" Lambert-Kay Modif.	825
Aorta Clamps	849	" Lees	826
" Blalock	849	" Leland-Jones	827
" Pott (Johns-Hopkins)	849	" Morris-De Bakey	820
" Potts-Smith	849	" Ochsner	829
Aorta Retractors Cooley	850	" Parry-Cooley	834
Aortic Biptome	844	" Potts	821, 822
" Brock	844	" Rein	828
" Schulz	844	" Satinsky	824
Aortic Dilators	844	" Satinsky-De Bakey	824
Appendorf Uterine Biopsy Forceps	895, 898	" Weber	828
Arrowsmith Ophthalmic Radial Keratomy Forceps	737	" Werthiem	837
Arruga Eye Speculum	703	Atrauma Forceps Hysterectomy and Vaginal	201-203
Arruga Micro Needle Holders	269, 272	" Dick	202
Arruga Needle Holders with T/C	267	" Wertheim	202, 203
Arruga Ophthalmic Capsular Forceps	730	" Roger	201
Arruga Ophthalmic Hooklets	712	Atrauma Forceps Kidney Pedicle Clamps	201, 868
Arruga Ophthalmic Retractors	713	" Werthiem	868
Arruga Ophthalmic Trephines	721	" Guyon	201
Arruga-Nizetic Ophthalmic Capsular Forceps	730	Atrauma Forceps Prostatectomy Millin	871
Art Ophthalmic Scoops	715	Atrauma Forceps Ureter	872
Artery Forceps	172, 173	Atrauma Forceps Uro-Tangential	203
Arthur Splinter Forceps	148	Atrauma Forceps Uterine Polypus and Ovum	888
Asch Biopsy Curettes	907	Atrauma Haemorrhoidal Forceps	801
Asch Rhinoplastic Forceps	642	Atrauma Haemostatic Forceps	809, 810
Asch Secretion Curettes	876	" De Bakey-Bainbridge	810
Aspiration Curettes	917	" De Bakey-Kelly	809
Assistant Standard Pocket Instrument Set	295	" De Bakey-Kelly-Rankin	809
Atlee Atrauma Cardiovascular Forceps	825	" De Bakey-Mosquito	809
Atrauma Anastomosis Forceps Dick	789	" De Bakey-Pean	810
Atrauma Aorta Clamps	841	Atrauma Intestinal and Stomach Clamp Forceps	785-789
" Hume	841	" Forceps Doyen	785
" Pappen-Blalock	841	" Forceps Glassman	788
" Schumaker	841	" Forceps Habere	789
Atrauma Biopsy Forceps for Rectum	804	" Forceps Hartmann	787
Atrauma Bulldog Clamps	808, 809	" Forceps Kocher	786
" De Bakey	808, 809	" Forceps Mayo-Robson	787
" De Bakey-Carotis	809	" Forceps Scudder	787
" De Bakey-Satinsky	809	Atrauma Intestinal Clamp Forceps	793, 794
" Glover	808	" Brunner	793
" Gregory-Soft	809	" Kersting	794
Atrauma Cardiovascular Forceps	811-837	Atrauma Sigmoid Anastomosis Forceps	790-793
" Atlee	825	" De Bakey (Morris Modif.)	793
" Castaneda	826	" Fehland	792
" Castaneda	829	" Glassman	790

	Page		Page
Atrauma Sigmoid Anastomosis Forceps (cont'd)		Baginsky Tongue Depressors	571
" Heyes	790	Baginsky Tonsillectomes	598
" Kersting	791	Bailey Rib Spreaders and Contractors	535
" Morris	793	Bailey-Baby Rib Spreaders and Contractors	535
" Resano	792	Bailey-Glover-O'Neil Valvulotomes	851
" Veidenheimer	791	Bailey-Williamson Obstetrical Forceps	961
Atrauma Tissue and Organ Holding Forceps	770	Bainbridge Haemostatic Forceps	170
" Allis	770	Bainbridge-Baby Haemostatic Forceps	170
" Collin	770	Bainbridge-Glassman Haemostatic Forceps	169
" Glassman-Allis	770	Bainbridge Intestinal Clamp Forceps	772
" Glassman-Babcock	770	Bakes Gall Duct Dilators	863
Atrauma Tissue Forceps	842, 843	Balfour Abdominal Retractor	406, 407
" Cooley	843	Balfour-Baby Abdominal Retractor	406
" De Bakey	842	Ballenger Nasal Knives	626
" Glassman	843	Ballenger Septum Knives	627
Aubaret Ophthalmic Retractors	713	Ballenger Tonsil Seizing Forceps	594
Aufricht Bone Files	474	Ballentine Hysterectomy Forceps	193
Aufricht Rhinoplastic Files	639	Band Moving Curettes Scoville	761
Aufricht Rhinoplastic Retractors	638	Bandage Roller	107
Aufricht Rhinoplastic Scissors	646	Bandage Scissors	104-107
Aufranc Bone Levers	472	Bandage Scissors with T/C	103
Automatic Cilia Forceps	150	Bane Bone Rongeurs	496
Auvarad Basiotribes	957	Barbara Ear Hooks	693
Auvarad Vaginal Speculum	927	Barbara Ear Needles	693
Auvarad-Zweifel Basiotribes	957	Barbara Ear Picks	693
Awls	586	Barens Cranioclast	956
" Kelsey-Fry	586	Barens Micro Needle Holders	269
" Obwegesser	586	Barens Obstetrical Forceps	962
" Sanders-Brown	586	Barens Ophthalmic Advancement Forceps	736
Axenfeld Eye Speculum	703	Barens Ophthalmic Keralomes	707
Axenfeld Ophthalmic Dissectors	718	Barens Ophthalmic Knives	707
Axenfeld Ophthalmic Knives	709	Barens Ophthalmic Lens Expressors	713
Axenfeld Ophthalmic Retractors	713	Barens Suturing Spatula	705
Axhausen Needle Holders	250	Barkan Ophthalmic Knives	709
Ayre Chalazion Forceps	737	Barker Amputation Saws	117
Ayre Cone Knives	35, 902	Barnes-Neville Obstetrical Forceps	964
<b>B</b>		Barnhill Adenoid Curettes	651
B. P. Handles	20-23	Barr Rectal Specula	797
Babcock Lung Grasping Forceps	537	Barraquer (Colibri) Eye Speculum	702
Babcock Tissue and Organ Holding Forceps	769	Barraquer (Colibri) Ophthalmic Fixation Forceps	727
Babcock Tissue and Organ Holding Forceps with T/C	770	Barraquer Micro Needle Holders	269, 270
Babcock-Baby Tissue and Organ Holding Forceps	769	Barraquer Modif. Ophthalmic Strabismus Forceps	733
Babere Intestinal and Stomach Clamp Forceps	782	Barraquer Ophthalmic Anterior Chamber Forceps	735
Babinski Percussion Hammer	16	Barraquer Ophthalmic Capsular Forceps	731
Baby-Adson Dissecting and Ligature Forceps	181	Barraquer Ophthalmic Fixation Forceps	728
Baby-Collin Retractor	401	Barraquer Ophthalmic Knives	706, 709
Baby-Crile Haemostatic Forceps	164	Barraquer Ophthalmic Micro Scissors	738
Baby-Crile-Wood Needle Holders with T/C	259	Barraquer Retractor	379
Baby-Esmarch Anaesthesia Mask	15	Barraquer-Katzin (Colibri) Ophthalmic Fixation Forceps	727
Baby-Kocher Intestinal Clamp Forceps	772	Barraquer-Katzin Ophthalmic Fixation Forceps	727
Baby-Mikulicz Peritoneal Clamp Forceps	204	Barraquer-Llovera Ophthalmic Fixation Forceps	728
Baby-Mixer Dissecting and Ligature Forceps	184	Barraquer-Troulman Micro Needle Holders	270
Baby-Overholt Haemostatic Forceps	171	Barsky Retractor	306
Baby-Roux Retractor	375	Barth Bone Curettes	476
Baby-Satinsky Vena Cava Clamps	852	Barton Obstetrical Forceps	962
Baby-Senn-Miller Retractor	308	Basin Triangular	987, 988
Baby-Tischler Uterine Biopsy Forceps	898	Basiotribes	957
Backhaus Towel Forceps	211	" Auvarad	957
Backhaus-Kocher Towel Forceps	211	" Auvarad-Zweifel	957
Backmann-Eaton Retractor	390	" Tarnier	957
Bacon Bone Rongeurs	494	Battery Handles for Diagnostic Sets	12
Badgley Abdominal Retractor	407	Baxt Laryngeal Mirrors	581
Baer Rib Shears	522	Beacham Uterine Tenaculum Forceps	882
		Beaupre Cilia Forceps	150
		Becker Oesophagus Dissectors	794

	Page		Page
Beckmann Adenoid Curettes	648	Biopsy Forceps for Rectum (cont'd)	
Beckmann Nasal Speculum	614	"    Jackson	805
Beckmann Retractor	390	"    Yeoman	804
Beckmann-Adson Retractor	391	Biopsy Uterine Forceps	891-898
Beckmann-Bayonet Retractor	392	"    Alexander	891
Bed Pan	988	"    Appendorf	895, 898
Beebee Ligature Scissors	55	"    Baby-Tischler	898
Beer Cilia Forceps	150	"    Burke	897, 898
Beer Ophthalmic Knives	706	"    Douay	896
Beeson Plaster Spreaders	113	"    Faure	894
Bellocq Cannula	653	"    Gaylor	893
Bellucci Ear Polypus Forceps	672	"    Gellhorn	893
Bellucci Micro Ear Scissors	676, 677	"    Kevorkian	893, 898
Bellucci Retractor	384	"    Kevorkian-Pacific	897, 898
Bengolea Haemostatic Forceps	167	"    Krause	896
Bennet Bone Levers	469	"    Medina	894
Bennet Cilia Forceps	149	"    Mini-Townsend	898
Bensaude Rectal Specula	798	"    Scheinmann	896
Benson Intestinal and Stomach Clamp Forceps	783	"    Schubert	891, 892
Berens Lid Everters	704	"    Schumacher	892, 895, 896
Berens Ophthalmic Hooks	712	"    Schumacher-Van Doren	892
Berens Ophthalmic Knives	706	"    Seidl	894
Berens Ophthalmic Muscular Clamp	735	"    Swiss Mod.	896
Berens Transplant Forceps	721	"    Thoms-Gaylor	893
Bergh Cilia Forceps	149	"    Tischler	894, 897, 898
Bergmann (Hibbs) Mallet	421	"    Tischler-Kevorkian	897, 898
Bergmann Bandage Scissors	106	"    Tischler-Morgan	897, 898
Bergmann Bone Osteotomes	441	"    Van Doren	892, 893
Bergmann Mallet	421	"    Wittner	895
Bergmann Operating Scalpel	30	Bioptome Aortic	844
Bergmann Retractor	303	"    Brock	844
Bergmann Saw	115	"    Schulz	844
Bergmann-Foerster Dressing and Sponge Holding Forceps	220	Bircher Meniscectomy Forceps	428
Bergstroem Gall Duct Forceps	857	Bircher Meniscectomy Knives	426
Berke Ophthalmic Muscular Forceps	735	Bircher-Ganske Meniscectomy Forceps	428
Berliner Percussion Hammer	18	Bircher-Granske Bone Holding Forceps	506
Bernhard Towel Forceps	213	Birkett Haemostatic Forceps	178
Bernhard Uterine Tenaculum Forceps	878	Bishop Bone Chisels	434
Berrett Uterine Tenaculum Forceps	878	Bishop Bone Gouges	433, 434
Bertillon Measuring Instrument	10	Bishop Ear Curettes	697
Bethune Rib Shears	522	Bishop Tendon Tucker	723
Beyer Bone Rongeurs	492, 498	Bishop Tongue Depressors	572
Beyer Punches	657	Bishop-Harman Ophthalmic Iris Forceps	725
Bier Amputation Saws	118	Bladder Retractor	415-418
Billeau Ear Loops	698	"    Collin	416
Billeau-Micro Ear Loops	698	"    Gosset	416
Billroth Retractor	325	"    Jacobson	415
Billroth Trocars	231	"    Judd-Masson	415
Binaural Accessories for Stethoscopes	9	"    Kocher	418
Binkhorst Ophthalmic Capsular Forceps	732	"    Legueu	417, 418
Biopsy Curettes	907, 908	"    Millian-Bacon	417
"    Asch	907	"    Millin	416, 417
"    Genell	908	"    Quervain	416
"    Gusberg	908	"    Thomsan-Walker	415
"    Kelly-Gray	908	"    Hryntschak	869
"    Kevorkian	907	Blades for Laryngoscopes	558-561
"    Mod. Berlin	908	Blake Embolus Grasping Forceps	850
"    Mod. Muenchen	908	Blake Gall Stone Forceps	859
"    Novak	907	Blake Uterine Curettes	914
"    Novak-Schoeckaert	907	Blakesley (Lewis) Nasal Polypus and Cutting Forceps	621
"    Randall	907	Blakesley Nasal Polypus and Cutting Forceps	621
"    Reich-Nechtow	907	Blalock Aorta Clamps	849
Biopsy Forceps for Rectum	804-806	Blascovics Ophthalmic Knives	709
"    Atrauma	804	Blascovics Ophthalmic Muscular Forceps	735
"    Herget	805	Blohmke Tonsil Seizing Forceps	595



# INHALTSVERZEICHNIS INDEX INDEX

	Page		Page
Blount Bone Levers	465, 466	" Rowe-Harrison	507
Blount Retractor	333	" Self Centering	513
Blumenthal Bone Rongeurs	495	" Semb	507
Blumenthal Uterine Dressing Forceps	887	" Steinhauser	503
Boer Craniotomy Forceps	956	" Tuffier	510
Boerma Obstetrical Forceps	958	" Ulrich	512
Boettcher Ligature Carriers	590	" Van Buren	506
Boettcher Tonsil and Nasal Scissors	80	" Verbugge	512, 515
Bohler Bone Cutters	488	Bone Levers	463-472
Bohler Bone Rongeurs	497	Bone Osteotomies	434-447
Bohler Extension Bows	545	Bone Plate Benders	544
Boley Caliper	968	Bone Rongeurs	491-502
Bonaccolto Dressing Forceps	140	" Adson	496
Bonaccolto Ophthalmic Strabismus Forceps	733, 734	" Alexander	493
Bone Chisels	433-447	" Bacon	494
Bone Curettes	476-483	" Bane	496
Bone Cutting Forceps	484-490	" Beyer	492, 498
" Bohler	488	" Blumenthal	495
" Cleveland	484	" Bohler	497
" Cottle	485	" Cleveland	494
" Horsley	485, 486	" Cohen	491
" Kazanjian	485	" Cottle-Jansen	493
" Killian	488	" Echlin	499
" Liston	486, 487, 489	" Fisch	492
" Liston-Key-Horsley	490	" Freidmann	491
" Liston-Stille	489	" Frykholm	499
" Littauer-Liston	485	" Geiger	498
" Markwalder	486	" Guleke	496
" McIndoe	488	" Hakansson	495
" Muhling	488	" Jansen	493
" Niro	485	" Kleinert-Kutz	495, 498
" Ruskin-Liston	487	" Leksell	500
" Ruskin-Rowland	487	" Lempert	494, 496
" Semb	490	" Luer	492
" Stamm	486	" Luer-Freidmann	491
" Tudor-Edwards	490	" Markwalder	502
Bone Elevators	461-463	" Marquardt	497
Bone Files	473-475	" Mayfield	498
Bone Gouges	433-447	" Mead	494, 495
Bone Holding Clamp Forceps	517	" Mini-Freidmann	491
" Bunnell-Howard	517	" Olivecrona	496
" Lambert-Lowmann	517	" Peiper-Beyer	498
" Lowmann	516	" Rottgen-Ruskin	497
" Lowmann-Gerster	517	" Ruskin	497
" Lowmann-Hoglund	517	" Ruskin-Mini	497
" Perham	517	" Sauerbruch-Coryllos	502
Bone Holding Forceps	503-517	" Sauerbruch-Stille	502
" Bircher-Granske	506	" Schell	496
" Dingmann	505	" Semb	499
" Farabeuf	510	" Smith-Petersen	500
" Farabeuf-Lambotte	510	" Stellbrink	491
" Fergusson	507	" Stille	500
" Frosch	507	" Stille-Leksell	499
" Haase	503	" Stille-Luer	501
" Hey-Groves	514	" Stille-Ruskin	501
" Kern	508	" Syptert	501
" Kern-Lane	508	" Trotter	494
" Kern-Mini	508	" Universal	494
" Lambotte	511	" Zaufal	495
" Lane	509	" Zaufal-Jansen	498
" Langenbeck	507	Bone Wire Guides	546-548
" Lewin	503	" Demel	547
" Meyer	504	" Kuntscher	546
" Perman	505	" Parham	548
" Reill	504	Bone Wire Tighteners	548, 549

	Page		Page
Bone Wire Tighteners (cont'd)		Brock Micro Needle Holders	272
" Demel	548	Brock Valvulotomes	851
" Loute	548	Brock-Bailey Valvulotomes	851
Boney Tissue Forceps	131	Brodie Rectal Probes	803
Bonn Ophthalmic Strabismus Forceps	733	Brom Retractor	307
Bonney Tissue Forceps with T/C	160	Broncho-Esophagoscopy Forceps	599-604
Bores Ophthalmic Radial Keratotomy Forceps	737	" Chevalier-Jackson	599, 602
Bose Retractor	303, 379	" Jackson	604
Bose Tracheal Retractors	608	" Original-Jackson	601, 603
Bosworth Tongue Depressors	571	" Peterson	602
Boucheron Ear Speculum	680	" Rntne Hospital	601
Bovin Uterine Tenaculum Forceps	885	Broncho-Esophagoscopy Scissors	602, 603
Bowles Stethoscope	5	Bronchus and Gall Duct Clamps	187-189
Bowls	982	" Crile-Mixter	188
" Round	982	" Dean-Shallcross	189
" Solution	982	" Desjardins	189
" Wash	982	" Finochietto	188
Bowmann Discission Needles	711	" Gray	189
Bowmann Eye Speculum	702	" Lahey	188
Bowmann Ophthalmic Knives	708	" Lahey (Sweet)	188
Bowmann (Williams) Lachrymal Probes	720	" Lower	188
Bowmann Lachrymal Probes	719, 720	" McQuigg-Mixter	188
Box for Instruments	985, 986	" Mixeter-O'Shaugnessy	187
Boynton Needle Holders with T/C	267	" Mixter	187, 189
Boys-Allis Tissue and Organ Holding Forceps	767	" Rochester-Mixter	187
Bozemann Dressing and Washing Forceps	224	" Wickstrom	187
Bozemann Gynecological Scissors	83	Bronchus Forceps	536, 537
Bozemann Needle Holders	249	" Price Thomas	536
Bozemann Needle Holders with T/C	264	" Sarot	536
Bozemann Suture Instruments	291	" Semb	536
Bozemann Uterine Dressing Forceps	886	Brophy Dressing Forceps	134
Bozemann Vaginal Speculum	930	Brophy Tissue Forceps	134
Bozemann-Douglas Dressing and Washing Forceps	224	Brophy Tonsil Knives	588
Bozemann-Douglas Uterine Dressing Forceps	886	Brown Needle Holders	243
Bozemann-Fritsch Uterine Catheters	916	Brown Tissue Forceps	138
Braatz Krause Ligature Conductors	290	Brown Tonsil Snares	597
Brain Spatulas	763	Bruce Clark Needle Holders	244
" Cushing	763	Bruehl Ear Knives	689
" Heifetz	763	Bruenings (Lucas) Bone Chisels	436
" Olivecrona	763	Bruenings (Lucas) Bone Gouges	436
Braith-Waite Suture Forceps	293	Bruenings Ear Speculum	682
Brand Suction Tubes	807	Bruenings Grasping Forceps Tips	600
Brand Tendon Seizing Forceps	429, 432	Bruenings Handle Broncho-Esophagoscopy Forceps	599
Brand Tendon Seizing Instrument	430	Bruenings Nasal Knives	626
Brasstad Rib Spreaders	532	Bruenings Nasal Polypus and Cutting Forceps	621
Braun Cranioclast	956	Bruenings Tongue Depressors	570
Braun Decapitating Hooks	951	Bruenings Tonsil Knives	587
Braun Uterine Depressors	902	Bruenings Tonsil Snares	596
Braun Uterine Tenaculum Forceps	878, 879	Brunetti Bone Osteotomes	442
Braun Vaginal Speculum	932	Brunner Atrauma Intestinal Clamp Forceps	793
Braun-Stadler Bandage Scissors	107	Brunner Intestinal Clamp Forceps	777
Braun-Stadler Episiotomy Scissors	85, 953	Brunner Ligature Conductors	287, 290
Braun-Stadler Sternum Scissors	523	Brunner Ligature Needles	280, 285
Breisky (Wiener Model) Vaginal Speculum	934	Brunner Retractor	355-358
Breisky Pelvimeters	955	Brunner Rib Shears	521
Breisky Retractor	351	Bruns (Volkman) Bone Curettes	480
Breisky Vaginal Speculum	931	Bruns Amputation Saws	119
Brich Trocars	232	Bruns Bandage Scissors with T/C	103
Bridge Haemostatic Forceps	178	Bruns Bone Curettes	478, 479
Brinkerhoff Rectal Specula	797	Bruns Bone Gouges	441
Bristow Bone Levers	471	Bruns Chisels	441
Bristow Raspatories	458	Bruns Plaster Shears	111
Brock Aortic Biopptome	844	Bryant Dressing and Sponge Holding Forceps	215, 216
Brock Dilation Sounds	850	Buchs Raspatories	460
Brock Micro Forceps	157	Buchs Retractor	341



# INHALTSVERZEICHNIS INDEX INDEX

	Page		Page
Buchwald Tongue Depressors	569	Cannulas (cont'd)	
Buck Ear Curettes	696	" Antrum Eicken	652
Buck Ear Knives	688	" Antrum Killian	652
Buck Ear Polypus Forceps	672	" Bellocq	653
Buck Ligature Scissors	54	" Guilen	653
Buck Paracentesis Needles	689, 690	" Hajek	653
Buck Percussion Hammers	17	" Hartmann	653
Buck Suture Scissors	294	" Myles	653
Bucket for Waste	988	" Rectal Katzenstein	807
Buck-Gramcko Bone Gouges	433	" Ritter-Halle Probes	653
Buck-Gramcko Bone Levers	464, 465	" Siebenmann	653
Buckingham Elevators	694	" Vessel Irrigating	845
Buckley Bone Chisels	433	" Vessel Irrigating Cooley	845
Buckley Retractor	379	" Vessel Irrigating Schmid	845
Bucy Neuro Knives	762	Canny Ryall Retractor	369
Buehressen Tissue Forceps	138	Caplan Septum Scissors	632
Buelau Trocars	231	Cardiovascular Atrauma Forceps	811-837
Buie Angiotribes	180	" Atlee	825
Buie Rectal Probes	803	" Castaneda	826, 829
Buie Suction Tubes	807	" Cooley	832-835
Bulldog Atrauma Clamps	808, 809	" Cooley-Glassman	836
" De Bakey	808, 809	" Dale	830
" De bakey-Carotis	809	" Dardik	831
" De Bakey-Satinsky	809	" De Bakey	811-819
" Glover	808	" De Bakey-Beck	820
" Gregory-Soft	809	" De Bakey-Harken	827
Bulldog Clamps	207, 208	" De Bakey-McQuigg-Mixer	818
" De Bakey	207	" De Bakey-Mixter	817
" De Bakey-Hess	208	" De Bakey-Rumel	817
" Dieffenbach	207	" De Bakey-Semb	816
" Johns-Hopkins	207, 208	" Derra	830
" Micro-Coron	208	" Derra-Cooley	832
" Ultra-Micro	208	Cardiovascular Atrauma Forceps	
Bumm Uterine Curettes	912	" Dick	837
Bumm Uterine Dressing Forceps	887	" Dietrich	829
Bunge Exenteration Scoops	718	" Glover	821
Bunnell Hand Drills	539	" Glover-De Bakey	825
Bunnell-Howard Bone Holding Clamp Forceps	517	" Gregory	829
Bunnell Bone Levers	464	" Henly	830
Bunnell Tendon Seizing Instrument	429, 430	" Lambert-Kay	825
Bunt Safety Pins	969	" Lambert-Kay Modif.	825
Burch Ophthalmic Knives	709	" Lees	826
Burford Rib Spreaders	529	" Leland-Jones	827
Burke Uterine Biopsy Forceps	897, 898	" Morris-De Bakey	820
Burs Corneal Storz	722	" Ochsner	829
Busch Operating Scissors	63	" Parry-Cooley	834
Busch Bone Curettes	481	" Potts	821, 822
Butcher Amputation Saws	117	" Rein	828
Byrd Suction Tubes	239	" Satinsky	824
		" Satinsky-De Bakey	824
		" Weber	828
		" Werthiem	837
<b>C</b>		Carmalt Splinter Forceps	145
Calipers	10, 723, 968	Caroll Tendon Seizing Forceps	432
" Boley	968	Carpenter Tonsil Knives	589
" Castroviejo	10, 723	Carrel (Reynolds) Haemostatic Forceps	161
" Castroviejo-Schachar	723	Carter Septum and Periosteal Elevators	629
" Iwanson	968	Carter Sphere Introducer	738
Campbell Trocars	231	Cartilage Forceps	428
Canad. Model Meniscectomy Knives	426	" Bircher	428
Canaliculus Punches	722	" Bircher-Ganske	428
" Haitz	722	" Herz	428
" Holth	722	" Jager	428
" Lagrange	722	" Weller	428
Canfield Tonsil Knives	587	Caspar Bone Curettes	481, 482
Cannulas	652, 653		



# INHALTSVERZEICHNIS INDEX INDEX

	Page		Page
Caspar Raspatories	457	" Thorpe	717
Caspar Retractor	307, 342	Chalazion Forceps	737-738
Caspar Rongeurs	664, 667, 668	" Ayer	737
Caspar Suture Instruments	291	" Cauer	737
Caspar Tampers	448	" Desmarres	738
Castanares Rhinoplastic Scissors	645	" Erhardt	737
Castaneda Atrauma Cardiovascular Forceps	826, 829	" Francis	738
Castaneda Neonatal and Pediatric Clamps	840	" Heath	737
Castaneda Rib Spreaders	532	" Hunt	738
Castroviejo Calipers	10, 723	" Lambert	737
Castroviejo Double Instruments	724	" Lordan	738
Castroviejo Lachrymal Dilators	720	" Snellen	737
Castroviejo Measuring Instrument	10, 723	" Spencer	738
Castroviejo Micro Needle Holders with T/C	268	" Weaver	738
Castroviejo Ophthalmic Capsular Forceps	730	" Weis	738
Castroviejo Ophthalmic Clamp	705	Chandler Ophthalmic Iris Forceps	727
Castroviejo Ophthalmic Corneal Scissors	742	Channelled Retractors	577
Castroviejo Ophthalmic Fixation Forceps	727	Chaput Tissue and Organ Holding Forceps	179, 767
Castroviejo Ophthalmic Iridectomy Scissors	742	Charnley Retractor	393
Castroviejo Ophthalmic Keratomes	707	Charriere Amputation Saws	116, 117
Castroviejo Ophthalmic Knives	706, 707	Cheattle Sterilizing Forceps	965, 966
Castroviejo Ophthalmic Micro Scissors	739	Cheek and Lip Retractors	572, 573
Castroviejo Ophthalmic Spatulas	714	Cheron Dressing and Washing Forceps	225
Castroviejo Ophthalmic Suture Forceps	733	Cherry Abdominal Retractor	407
Castroviejo Ophthalmic Tenotomy Scissors	741	Chevalier-Jackson Broncho-Esophagoscopy Forceps	599, 602
Castroviejo Ophthalmic Trephines	721, 722	Chevalier-Jackson Tracheal Tubes	610
Castroviejo Razor Blade Holder	24	Child Suture Forceps	292
Castroviejo-Colibri Ophthalmic Fixation Forceps	728	Chin Retractors	577
Castroviejo-Kalt Micro Needle Holders	269	Chiron Otoscope	12
Castroviejo-Schachar Calipers	723	Chisel Rhinoplastic	633-636
Castroviejo Micro Needle Holders	271, 272, 274	" Anderson-Neivert	636
Castroviejo-Barraquer Micro Needle Holders	274	" Cinelli	636
Cataract Operating Instruments Kirby	716	" Cottle	634
Catheter Forceps Magil	569	" Fomon	636
Catheter Introducing Forceps Sokeland	865	" Freer	633
Catheters	652, 653, 671, 865, 873, 916	" McIndoe	636
" Ear	671	" Metzbaum	633
" Ear Hartmann	671	" Moberg	636
" Ear Itard	671	" Neivert	636
" Ear Troeltsch	671	" Rubin	633, 636
Catheters Hirth	865	" Silver	635
Catheters Killian	653	" Swall	633
Catheters Uterine	916	" Walter	634
" Bozemann-Fritsch	916	Chisels Bone	433-447
" Hildebrandt	916	" Alexander	439
Catheters Van Alyea	652	" Bishop	434
Catheter Guides	873	" Bruenings (Lucas)	436
Catlin Amputation Knives	41	" Bruns Chisels Bone	441
Carotid Clamps Pertuiset	855	" Buckley	433
Cauer Chalazion Forceps	737	" Cottle	438
Caustic Holders	901	" Freer	435
Cauteries	714	" Hibbs	436
" Prince	714	" Lexer	447
" Wadsworth-Todd	714	" Lucas	438
" Wills-Hospital	714	" McEwen	440
Center Blade for Balfour Abdominal Retractor	407	" Partsch	435
Cervical Traction Tongues	755, 756	" Schwartze	433
Chadwick Scissors	48	" Stille Chisels Bone	440
Chalazion Curettes	717, 718	" Trautmann	433
" Daviel	717	" U. S. Army	439
" Graefe	717	Chisels Lachrymal Sac West	723
" Heath	718	Chisels Ophthalmic	710
" Hebra	717	" Green	710
" Meyhoefer	717	" Knapp	710
" Skeeel	717	" Nicati	710



# INHALTSVERZEICHNIS INDEX INDEX

	Page		Page
Chisels Ophthalmic (cont'd)		Clamps Bulldog (cont'd)	
" Rollet	710	" Dieffenbach	207
Cholewa Nasal Speculum	618	" Johns-Hopkins	207, 208
Choyce Ophthalmic Capsular Forceps	731	" Micro-Coron	208
Church Vascular Scissors	76	" Ultra-Micro	208
Cilia Forceps	149 & 150	Clamps Circumcision	877
" Automatic	150	" Guyon	190, 191
" Beaupre	150	" Guyon Atrauma	201
" Beer	150	" Herrick	190
" Bennett	149	" Mayo	191
" Bergh	149	" Mayo-Guyon	191
" Douglas	149	" Stille	190
" Douglas	150	Clamps Neonatal and Pediatric	837-840
" Gradle	150	" Castaneda	840
" Graefe	149	" Cooley	838, 839
" Henry	150	" Subramanian-Miniature	837
" Jameson-Evans	150	Clamps Penis	871, 872
" Kuhne	149	Clamps Peritoneal	204-206
" Littauer	149	" Baby-Mikulicz	204
" Phillips	150	" Faure	205
" Saupe	149	" Mikulicz	204-206
" Ziegler	149	" Schindler	206
Cinelli Rhinoplastic Chisel	636	Clamps Tubing	209, 210, 969
Cinelli Rhinoplastic Scissors	646	" Hoffmann	969
Circumcision Clamps	877	" Holt	969
Citelli Punches	657	" Marcuse	210
Clamp for Fixation of Spermatic cord	871	" Mod. Klinikum-Berlin	210
Clamps Aorta	849	" Mohr	969
" Blalock	849	" Sell	969
" Pott (Johns-Hopkins)	849	" Simplex	969
" Potts-Smith	849	" St. Vincent	209
Clamps Atrauma Aorta	841	" Standard	209
" Hume	841	" Ulrich	969
" Pappen-Blalock	841	Clamps Umbilical Cord	953
" Schumaker	841	" Collin	953
Clamps Bone Holding	517	" Kane	953
" Bunnel-Howard	517	Clamps Vena Cava	852, 853
" Lambert-Lowmann	517	" Baby-Satinsky	852
" Lowmann	516	" Harken	853
" Lowmann-Gerster	517	" Hopfner	852
" Lowmann-Hoglund	517	" Potts-Satinsky	852
" Perham	517	" Satinsky	852
Clamps Bronchus and Gall Duct	187-189	Clamps Vessel	854, 855
" Crile-Mixter	188	" Derra	854
" Dean-Shallcross	189	" Johns-Hopkins	854
" Desjardins	189	" Potts	854, 855
" Finocchietto	188	" Potts-Glover	854
" Gray	189	" Potts-Satinsky	855
" Lahey	188	Clark-Verhoeff Ophthalmic Fixation Forceps	729
" Lahey (Sweet)	188	Clas-Eicken Ligature Needles	285
" Lower	188	Clas-Eicken Tonsil Needles	593
" McQuigg-Mixter	188	Claus Ligature Needles	285
" Mixeter-O'Shaugnessy	187	Clayman Ophthalmic Capsular Forceps	731
" Mixter	187, 189	Cleveland Bone Cutters	484
" Rochester-Mixter	187	Cleveland Bone Rongeurs	494
" Wickstrom	187	Clip Applying Forceps	754
Clamps Bulldog Atrauma	808, 809	" McKenzie	754
" De Bakey	808, 809	" McKenzie Modif.	754
" De bakey-Carotis	809	" Olivecrona-Toennis (Scoville)	754
" De Bakey-Satinsky	809	" Raney	754
" Glover	808	Clips Micro Aneurysm and Vessel	753
" Gregory-Soft	809	" Jacobson-Potts	753
Clamps Bulldog	207, 208	" Mini	753
" De Bakey	207	" Schwartz	753
" De Bakey-Hess	208	" Standard	753





INVENT GERMANY

# INHALTSVERZEICHNIS INDEX INDEX

	Page		Page
Cloth Scissors	108	Converse Nasal Knives	625
Cloward Modif. Retractor	398	Converse Needle Holders	241, 245
Cloward Retractor	385, 388, 398, 399	Converse Needle Holders with T/C	259, 260
Cloward Rongeurs	664	Converse Rhinoplastic Files	641
Cloward-Hoen Retractor	400	Converse Rhinoplastic Retractors	638
Cloward-Lumber Retractor	400	Converse Rhinoplastic Scissors	645
Coakley Rhinoplastic Sharp Curettes	647	Converse Septum and Periosteal Elevators	630
Coakley Trocars	230	Conway Lid Retractors	704
Cobb Raspatories	460	Cook Eye Speculum	703
Cogswell Suction Tubes	239	Cook Rectal Specula	795
Cohen Bone Rongeurs	491	Cooley Aorta Retractors	850
Cohen Cuticle Nippers	122	Cooley Aortic Dilators	844
Cohen Raspatories	453	Cooley Atrauma Cardiovascular Forceps	832-835
Colclough (Richter) Punches	659	Cooley Atrauma Tissue Forceps	843
Colclough Punches	659, 660	Cooley Neonatal and Pediatric Clamps	838, 839
Coller-Crile Haemostatic Forceps	165	Cooley Retractor	367
Collier Needle Holders	242, 247	Cooley Rib Spreaders	524, 531
Collin Amputation Knives	41, 42	Cooley Suction Tubes	236
Collin Amputation Saws	117	Cooley Vessel Irrigating Cannulas	845
Collin Atrauma Tissue and Organ Holding Forceps	770	Cooley-Glassman Atrauma Cardiovascular Forceps	836
Collin Bladder Retractor	416	Cooper Ligature Needles	280
Collin Dressing and Washing Forceps	225	Cope Retractor	308
Collin Duval Tissue Forceps	141	Cordes (Rocenberg) Cutting Forceps Tips	600
Collin Kidney Elevating Forceps	867	Cordes Cutting Forceps Tips	600
Collin Mallet	423	Cordes Nasal Cutting Forceps	624
Collin Measuring Instrument	10	Corey Placenta and Ovum Forceps	950
Collin Operating Scalpel	31	Corneal Burs Storz	722
Collin Pelvimeters	954	Coryllos Retractor	359, 360
Collin Retractor	377, 402	Coryllos-Bethune (Collin) Rib Shears	522
Collin Rib Shears	520	Cottle (Bulldog) Rhinoplastic Scissors	645
Collin Scalpel Handle	22	Cottle Bone Chisels	438
Collin Sterilizing Forceps	966	Cottle Bone Cutters	485
Collin Suture Forceps	293	Cottle Bone Osteotomes	438
Collin Tissue and Organ Holding Forceps	179	Cottle Dressing Forceps	142
Collin Tongue Holding Forceps	578	Cottle Mallet	421
Collin Tracheal Tubes	610	Cottle Nasal Knives	625
Collin Umbilical Cord Clamps	953	Cottle Nasal Speculum	615, 616
Collin Uterine Curettes	913	Cottle Periosteal Elevators	631
Collin Uterine Elevating Forceps	888, 890	Cottle Raspatories	454, 456
Collin Uterine Sounds	900	Cottle Retractor	299, 303
Collin Vaginal Speculum	923	Cottle Rhinoplastic Chisel	634
Collin Vaginal Speculum	924, 925	Cottle Rhinoplastic Files	639
Collin-Hartmann Retractor	378	Cottle Rhinoplastic Forceps	644
Collin-Landau Vaginal Speculum	925	Cottle Rhinoplastic Hammers	647
Collin-Loktite Retractor	402	Cottle Rhinoplastic Hooks	637
Collin-Pozzi Uterine Tenaculum Forceps	881	Cottle Rhinoplastic Instruments	631
Collyer Pelvimeters	955	Cottle Rhinoplastic Osteotomes	634, 635
Colver Tonsil Knives	588	Cottle Rhinoplastic Retractors	635, 637
Colver Tonsil Seizing Forceps	594	Cottle Rhinoplastic Saws	642
Comedo Extractors	765, 766	Cottle Rhinoplastic Scissors	645
"    Hebra	765	Cottle Septum and Periosteal Elevators	629, 630
"    Katsch	765	Cottle Septum Scissors	632
"    Saalfeld	766	Cottle Tonsil and Nasal Scissors	79
"    Schamberg	766	Cottle-Jansen Bone Rongeurs	493
"    Unna	766	Cottle-Masing Rhinoplastic Forceps	643
"    Unna-Vidal	765	Cottle-McKenty Periosteal Elevators	631
Commander Plaster Shears	110	Cottle-Neivert Rhinoplastic Hooks	637
Cone Knives	35, 902	Cottle-Walsham Rhinoplastic Forceps	643
Cone Pituitary Curettes	761	Cotton and Wool Containers	981
Connin-Amsler Lachrymal Marker	723	Cotton Dispenser	989
Container for Dentures	986	Cotton Holders	901
Containers for Cotton Wool and Pallets	981	"    Playfair	901
Containers for Instruments	979	"    Sims	901
Containers for Sterilizing	980	Cotton Receptacles	989
Converse Retractor	305	Coupland Suction Tubes	238



# INHALTSVERZEICHNIS INDEX INDEX

	Page		Page
Courty Retractor	392	Curettes Bone (cont'd)	
Courty-Fontaine Retractor	392	" Caspar	481, 482
Cover Ligature Carriers	590	" Daubenspeck	479
Coxeter Ear Curettes	696	" Halle	478
Crafoord Vascular Scissors	73	" Hemingway	476
Crafoord Dissecting and Ligature Forceps	184	" Jacobson	476
Crafoord-Sellors Dissecting and Ligature Forceps	182	" Jansen	476
Crafoord Rib Spreaders and Contractors	535	" Kerpel	477
Craft Ligature Needles	286	" Kramer	482
Craig Nasal Polypus and Septum Forceps	620	" Lempert	480
Craig-Dominick Nasal Polypus and Septum Forceps	620	" Lucas	476
Cranial Openers	754, 755	" Martini	476
Cranioclast	956	" Mod. USA	479
Craniotomy Forceps Boer	956	" Schede	477
Crawford Retractor	346	" Simon	481
Crile Gall Stone Forceps	860	" Spratt	478
Crile Haemostatic Forceps	164	" Sypert	483
Crile Needle Holders	250	" Tessier	482
Crile Nerve Hooks	849	" Uffenorde	478
Crile Retractor	302, 305, 3075	" Volkmann	476, 477, 479-481
Crile-Mixer Bronchus and Gall Duct Clamps	188	" Williger	476, 479
Crile-Murray Needle Holders	243	Curettes Chalazion	717, 718
Crile-Wood Needle Holders	243	" Daviel	717
Crile-Wood Needle Holders with T/C	259	" Graefe	717
Critchett Eye Speculum	702	" Heath	718
Crotti Retractor	393	" Hebra	717
Crowin Tonsil Haemostats	596	" Meyhoefer	717
Crura Nippers Micro	679	" Skeele	717
Crutchfield Cervical Traction Tong	755, 756	" Thorpe	717
Culler Cyclodialysis Spatulas	714	Curettes Ear	696, 697
Culler Ophthalmic Hooklets	712	" Antoli-Candela	697
Cups for Medicine	983	" Bishop	697
Cups Sputum	986	" Buck	696
Curdy Ophthalmic Knives	709	" Coxeter	696
Curettes Adenoid	648-652	" House	697
" Barnhill	651	" Langenbeck	696
" Ingersoll	649	" Lempert	700
" La Force	650	" Shapleigh	696
" La Force-Stevenson	650	" Wolf	697
" Middleton	649	" Yankauer	697
" Moure	651	Curettes Lucas	765
" Shambaugh	650	" Fox	765
" Shambaugh (Negus)	652	" Moncorps	765
" St. Clair-Thomson	649	" Piffard	765
" Stubbs	651	" Vidal	765
" Vogel	649	" Wolff	765
Curettes Aspiration	917	Curettes Ophthalmic	710
Curettes Band Moving Scoville	761	" Abadie	710
Curettes Biopsy	907, 908	" Alvis	710
" Asch	907	" Davis	710
" Genell	908	" Ellis	710
" Gusberg	908	" Francis	710
" Kelly-Gray	908	" Plange	710
" Kevorkian	907	Curettes Ovum	952
" Mod. Berlin	908	" Cuzzi	952
" Mod. Muenchen	908	" Pestalozza	952
" Novak	907	Curettes Pituitary	760, 761
" Novak-Schoeckaert	907	" Cone	761
" Randall	907	" Nicola	760
" Reich-Nechtow	907	" Ray	760
Curettes Bone	476-483	Curettes Rhinoplastic Sharp	647
" Barth	476	" Coakley	647
" Bruns	478, 479	" Dingman	647
" Bruns (Volkmann)	480	" Faulkner	647
" Busche	481	" Pratt	647

	Page		Page
Curettes Secretion	876	Dartigues Kidney Elevating Forceps	867
Curettes Uterine	909-915	Dartigues Retractor	395
" Blake	914	Dartigues Uterine Elevating Forceps	890
" Bumm	912	Dastoor Ophthalmic Spatulas	714
" Collin	913	Dastoor Ophthalmic Strabismus Forceps	734
" Greene	912	Dastoor Ophthalmic Suture Forceps	733
" Heaney	913	Dattner Hypodermic and Biopsy Needles	240
" J. O. M. W. Type	915	Daubenspeck Bone Curettes	479
" Milan	913	Davidson Retractor	363
" Recamier	909, 910	Daviel Chalazion Curettes	717
" Sims	911, 915	Daviel Ophthalmic Scoops	715
" Sims (Herrera)	911	Davis Dressing Forceps	141
" Thomas	914	Davis Dura Dissectors	757, 758
" Wallich	913	Davis Ophthalmic Curettes	710
" Wash	916	Davis Sterilizing Forceps	968
" Zaufel (Blake)	914	Davis Vascular Dissectors	848
Curshmann Trocars	232	Davis-Boyle Mouth Gags	566
Cusco Vaginal Speculum	922, 923	Davol Micro Introduction Instruments	679
Cushing Brain Spatulas	763	Day Hooklets	699
Cushing Dressing Forceps	135	Day Tonsil Knives	588
Cushing Dressing Forceps with T/C	158, 159	De Bakey (Morris Modif.) Atrauma Sigmoid Anastomosis Forceps	793
Cushing Dura Hooks	759	De Bakey Atrauma Bulldog Clamps	808, 809
Cushing Gland Spoons	761	De Bakey Atrauma Cardiovascular Forceps	811-819
Cushing Kocher Retractor	299, 301	De Bakey Atrauma Tissue Forceps	842
Cushing Neuro Elevators	761	De Bakey Bulldog Clamps	207
Cushing Raspatories	450, 452	De Bakey Dissecting Forceps	771
Cushing Retractor	298, 299, 306	De Bakey Needle Holders with T/C	260
Cushing Rongeurs	663	De Bakey Retractor	396
Cushing Tissue Forceps	135	De Bakey Rib Spreaders	527, 528
Cushing-Taylor Dressing Forceps with T/C	159	De Bakey Scissors with T/C	89
Cuticle Nippers	122	De Bakey Special Forceps	152
Cuticle Scissors	127	De Bakey Suction Tubes	234, 235
Cutting Forceps Tips	600	De Bakey Tissue Forceps with T/C	159
" Cordes	600	De Bakey Tunneling Instruments	846
" Cordes (Rocenberg)	600	De Bakey Vascular Dilators	845
" Krause	600	De Bakey Vascular Scissors	77, 855
" Scheinmann	600	De Bakey-Bainbridge Atrauma Haemostatic Forceps	810
" Schumacher	600	De Bakey-Beck Atrauma Cardiovascular Forceps	820
Cuzzi Ovum Curettes	952	De Bakey-Carotis Atrauma Bulldog Clamps	809
Cyclodialysis Spatulas	714	De Bakey-Harken Atrauma Cardiovascular Forceps	827
" Culler	714	De Bakey-Hess Bulldog Clamps	208
" Stock	714	De Bakey-Kelly Atrauma Haemostatic Forceps	809
" Suker	714	De Bakey-Kelly-Rankin Atrauma Haemostatic Forceps	809
" Weber	714	De Bakey-McQuigg-Mixter Atrauma Cardiovascular Forceps	818
" Wecker	714	De Bakey-Mixter Atrauma Cardiovascular Forceps	817
Cystotomes Ophthalmic	713	De Bakey-Mosquito Atrauma Haemostatic Forceps	809
" Graefe	713	De Bakey-Pean Atrauma Haemostatic Forceps	810
" Meyer-Schwickerath	713	De Bakey-Rumel Atrauma Cardiovascular Forceps	817
Czerny Gall Stone Forceps	858	De Bakey-Satinsky Atrauma Bulldog Clamps	809
Czerny Rectal Specula	795	De Bakey-Semb Atrauma Cardiovascular Forceps	816
Czerny Retractor	333, 376	De Lee Obstetrical Forceps	961
Czerny Uterine Tenaculum Forceps	879	De Lee Pelvimeters	954
		De Martel-Wolfson Intestinal and Stomach Clamp Forceps	784
		De Vilbiss Cranial Opener	755
		Dean Ophthalmic Knives	709
<b>D</b>		Dean Tonsil and Nasal Scissors	80
Da La Roza Ligature Needles	744	Dean Tonsil Knives	589
Dahlgren Cranial Opener	755	Dean-Shallcross Bronchus and Gall Duct Clamps	189
Daily Ophthalmic Knives	709	Deaver Operating Scissors	60
Dajerine Percussion Hammer	18	Deaver Retractor	364-367
Dale Atrauma Cardiovascular Forceps	830	Deaver Scissors with T/C	103
Dandy Haemostatic Forceps	162	Deaver-Baby Retractor	366
Dandy Nerve Hooks	759	Decapitating Hooks	951
Dandy Neuro Elevators	761	" Braun	951
Dardik Atrauma Cardiovascular Forceps	831	" Smellie	951
Darling Retractor	395		

	Page		Page
Delicate Scissors	44-52	Dilators Tracheal (cont'd)	
Demel Bone Wire Guides	547	"    Trousseau	607
Demel Bone Wire Tighteners	548	Dilators Tracheotomy	612
Demelis Obstetrical Forceps	963	Dilators Uterine	903-906
Dench Paracentesis Needles	689	"    Goodell	906
Denhardt Mouth Gags	562	"    Hank	905
Denis-Browne Abdominal Retractor	412	"    Hegar	903, 904
Denis-Browne Dissecting Forceps	771	"    Jolly	905
Deponette	975	"    Pratt	905
Depressors Uterine	902	"    Sims	906
"    Braun	902	"    Wylie	906
"    Sims	902	Dilators Van Buren	874
Derf Needle Holders	242	Dilators Vascular	845
Derf Needle Holders with T/C	258	Dingman Mouth Gags	567
Dermal Punches Keys	766	Dingman Rhinoplastic Sharp Curettes	647
Dermatology	765, 766	Dingmann Bone Holding Forceps	505
Dermor-Pierse (Colibri) Ophthalmic Fixation Forceps	736	Dintenfass Paracentesis Needles	689, 690
Dermor-Pierse Ophthalmic Fixation Forceps	736	Dissection Needles	711
Derra Atrauma Cardiovascular Forceps	830	"    Bowman	711
Derra Valvulotomes	851	"    Schweigger	711
Derra Vessel Clamps	854	Dishes	983
Derra-Cooley Atrauma Cardiovascular Forceps	832	Dishes Petri	983
Deschamps Ligature Needles	281, 282	Dishes Round	983
Desjardins Bronchus and Gall Duct Clamps	189	Disimpaction Forceps	585
Desjardins Gall Stone Forceps	858	Dispenser Cotton	989
Desjardins Gall Stone Scoops	861	Dispenser Gauze	989
Desjardins Probes	857	Dispenser Luniatschek	989
Desmarres Chalazion Forceps	738	Dispenser Method	989
Desmarres Lid Retractors	704	Dispenser Phillip	989
Desmarres Ophthalmic Knives	709	Dissecting and Ligature Forceps	181-186
Desmarres Retractor	300	"    Baby-Adson	181
Detachable Amputation Saws	116	"    Baby-Mixter	184
Deutschmann Ophthalmic Knives	706	"    Crafoord	184
Deweys Obstetrical Forceps	964	"    Crafoord-Sellors	182
Diagnostic Sets	12-14	"    Gemini	183
Dick Atrauma Anastomosis Forceps	789	"    Johns-Hopkins	184
Dick Atrauma Cardiovascular Forceps	837	"    Kelly	186
Dick Hysterectomy and Vaginal Atrauma Forceps	202	"    Lawrence	186
Dieffenbach Abscess Knives	34	"    Mini-Gemini	181
Dieffenbach Bulldog Clamps	207	"    Mixter	183
Dieffenbach Operating Scalpel	26, 30, 32	"    Mixter-Baby	184
Dietrich Atrauma Cardiovascular Forceps	829	"    Nissen	181
Dietrich Scissors with T/C	102	"    Overholt	181
Dietrich Vascular Scissors	74	"    Overholt-Geissendoerfer	185
Dilation Sounds Brock	850	"    Overholt-Mixter	182
Dilator and Spatula Robb	847	"    Rumel	182
Dilators Aortic	844	"    Sarot	183
"    Cooley	844	"    Zenker	184
"    Tube	844	Dissecting Forceps	771
Dilators Dittel	875	"    De Bakey	771
Dilators Gall Duct	862, 863	"    Denis-Browne	771
"    Bakes	863	"    Duval	771
"    Dittel	863	"    Stille-Barraya	771
"    Stucker	863	"    Wangensteen	771
Dilators Guyon	874	Dissecting Scissors	46, 65-71
Dilators Lachrymal	720, 721	Dissectors Becker Oesophagus	794
"    Castroviejo	720	Dissectors Dura	757-758
"    Galezowsky	720	"    Davis	757, 758
"    Muldoon	720	"    Frazier	757
"    Raverdino	720	"    Horsley	757
"    Simpson	720	"    Milligan	758
"    Wilder	720	"    Olivecrona	758
"    Ziegler	721	"    Penfield	757, 758
Dilators Tracheal	607	"    Saschs	757
"    Laborde	607	"    Toennis	757

	Page		Page
Dissectors Fisch	694	Dressing and Sponge Holding Forceps (cont'd)	
Dissectors Hurd	590	" Lister	215
Dissectors Micro Hardy	751	" Maier	219
Dissectors Ophthalmic	718	" Noto	219
" Axenfeld	718	" Pelkmann	220
" Lang	718	" Rampley	217
Dissectors Rosen	694	" Sims-Maier	218
Dissectors Vascular	848	Dressing and Washing Forceps	221-226
" Davis	848	" Bozemann	224
" Halle	848	" Bozemann-Douglas	224
" Toennis	848	" Cheron	225
Dittel Dilators	875	" Collin	225
Dittel Gall Duct Dilators	863	" Duplay	221
Dix Ophthalmic Gouges	711	" Gross	222
Dixon-Lovelace Haemostatic Forceps	166	" Maier	223
Dockhorn Retractor	344	" Pitha	222
Dogliottie Valvulotomes	851	" Westermark	226
Douay Uterine Biopsy Forceps	896	Dressing Drums	977
Double Instruments	724	Dressing Forceps with T/C	158-160
" Castroviejo	724	Dressing Forceps	128-143, 671
" Fisher	724	" Adson	139, 140
" Green	724	" Adson with T/C	158
" Knapp	724	" Bonaccolto	140
" Lindner	724	" Brophy	134
" McReynolds	724	" Cottle	142
" Moorfield	724	" Cushing	135
" Smith-Fisher	724	" Cushing with T/C	158, 159
" Wheeler	724	" Cushing-Taylor with T/C	159
Douglas Cilia Forceps	149, 150	" Davis	141
Douglas Tonsil and Nasal Scissors	79	" Duehrensen	132
Douglas Tonsil Knives	588	" Evans with T/C	159
Douglas Trocars	231, 233	" Fricke	132
Downing Meniscectomy Knives	427	" Gerald	137
Doyen Abdominal Retractor	414	" Gerald with T/C	160
Doyen Atrauma Intestinal and Stomach Clamp Forceps	785	" Gruenwald	142
Doyen Gall Duct Forceps	856	" Gruenwald (Jansen)	142
Doyen Gynecological Scissors	82	" Gruenwald with T/C	160
Doyen Intestinal Clamp Forceps	772, 773	" Hudson (Ewald)	139
Doyen Mallet	420	" Jansen	671
Doyen Needle Holders	242	" Lucae	142
Doyen Operating Scissors	62	" Lucae	671
Doyen Raspatories	456	" Mayo-Russian	141
Doyen Retractor	349, 351, 352	" McIndeo	132
Doyen Tongue Depressors	570	" McIndeo with T/C	159
Doyen Towel Forceps	214	" Micro-Adson	139
Doyen Tubal Operation Instruments	899	" Ochsner	132
Doyen Uterine Polypus and Ovum Forceps	888	" Potts-Smith	135
Doyen Vaginal Retractors	942	" Potts-Smith with T/C	159
Doyen Vaginal Speculum	933	" Ramsay	132
Doyen-Collin Mouth Gags	563	" Rochester	138
Doyen-Jansen Mouth Gags	563	" Select	131
Doyen-Stille Retractor	343	" Semken	133
Dressing and Cotton Swab Forceps	227, 228	" Semken with T/C	160
" Emmet	228	" Standard	138
" Sauerbruch	228	" Standard with T/C	158
" Ulrich	227, 228	" Stille	132
Dressing and Sponge Holding Forceps	215-220	" Taylor	135, 136
" Bergmann-Foerster	220	" Thorpe	140
" Bryant	215, 216	" Troeltsch	143
" Duplay	217	" Troeltsch (Wilde)	143
" Fletcher (Javerts)	220	" Troeltsch (Wilde)	671
" Foerster	215-217	" Wangenstein	134
" Gross	216	" Wangenstein with T/C	160
" Heywood-Smith	219	" Waugh	134
" Kelly	217	" Wilde	143



# INHALTSVERZEICHNIS INDEX INDEX

	Page		Page
Dressing Scissors Flat Shanks	58	Ear Curettes (cont'd)	
Dressing Scissors Round Shanks	56,57	" Bishop	697
Dressing Scissors Slim Pattern	59	" Buck	696
Dressing Scissors with T/C	100, 101	" Coxeter	696
Drill Chucks	538	" House	697
Drills	538-540	" Langenbeck	696
" Bunnel	539	" Lempert	700
" Hudson	540	" Shapleigh	696
" Moore	539	" Wolf	697
" Perthes	540	" Yankauer	697
" Ralk	539	Ear Elevators	700
" Stille	538	" Lempert	700
" Stille-Sherman	538	" McHough	700
" Steinhauser	669	Ear Excavators Lempert	700
Drivers Douflex Mod. Dejerine Percussion Hammer	19	Ear Hooks	693
Droeber Splinter Forceps	146	" Barbara	693
Dublin Operating Scissors	64	" Hartmann	698
Dubois Gynecological Scissors	83	" McGee	693
Duehresen Dressing Forceps	132	Ear Knives	688, 689
Duffield Vascular Scissors	76	" Bruehl	689
Duke Trocars	232	" Buck	688
Dunkel Vaginal Speculum	934	" Lempert	688
Dunn-Dautrey Tempromandibular Joint Instruments	584	" Muck	689
Duplay Dressing and Sponge Holding Forceps	217	" Plester	688
Duplay Dressing and Washing Forceps	221	" Politzer	689
Duplay Uterine Tenaculum Forceps	878	" Rosen	688
Dupuy-Weiss Ligature Needles	284	" Schuknecht	688
Dupuy-Weiss Tonsil Needles	592	" Tabb	688
Dura Dissectors	757-758	" Wullstein	688
" Davis	757, 758	Ear Loops	697, 698
" Frazier	757	" Billeau	698
" Horsley	757	" Billeau-Micro	698
" Milligan	758	" Gardner-Brown	697
" Olivecrona	758	" Gross	697
" Penfield	757, 758	" Roser	697
" Sachs	757	Ear Needles	693
" Toennis	757	" Barbara	693
Dura Hooks	749, 759	" Rosen	693
" Adson	759	Ear Picks Barbara	693
" Cushing	759	Ear Polypus Forceps	672, 673
" Graham	759	" Bellucci	672
" Lahey	759	" Buck	672
" Sachs	759	" Hartmann	672, 673
" Toennis	759	" Hartmann-Noyes	673
Dura Knives	32, 33	" Hartmann-Weingartner	673
" Halle	32	" Hartmann-Wullstein	673
" Toennis	33	" Littauer	672
Durante Tissue Forceps	138	" Mirco	673-676
Durham Ligature Needles	285	" Quire	672
Durham Tonsil Needles	593	" Struempel	673
Duval Dissecting Forceps	771	Ear Polypus Snare	671
Duval Lung Grasping Forceps	537	" Krause	671
Duval Tissue and Organ Holding Forceps	769	" Krause-Voss	671
Duval Tissue and Organ Holding Forceps with T/C	770	" Lange-Wilde	671
Duval Tissue Forceps	138	Ear Raspatories Lempert	700
Duval-Collin Tissue and Organ Holding Forceps	769	Ear Sounds Shambaugh	700
		Ear Speculum	680-683
		" Boucheron	680
		" Bruenings	682
		" Erhardt	682
		" Gruber	681
		" Hartmann	680
		" Holmagren	682
		" Paparella	682
		" Politzer	680
<b>E</b>			
Ear Catheters	671		
" Hartmann	671		
" Itard	671		
" Troeltsch	671		
Ear Curettes	696, 697		
" Antoli-Candela	697		

	Page		Page
Ear Speculum (cont'd)		" Alderdice	592
" Richnau-Holmgren	682	" Hartmann	592
" Siegle	683	" Yankauer	592
" Toynbee	680	Elliot Obstetrical Forceps	963
" Troeltsch	681	Elliot Ophthalmic Iris Forceps	726
" Zoeliner	681	Elliot Ophthalmic Trephines	721
Ear Syringes	701	Ellis Ophthalmic Curettes	710
Ear Syringes Luer-Lock	701	Elsasser Nephrostomy Forceps	866
Eastman Vaginal Speculum	931	Elschnig Ophthalmic Advancement Forceps	736
Ebstein Percussion Hammer	18	Elschnig Ophthalmic Capsular Forceps	730
Echlin Bone Rongeurs	499	Elschnig Ophthalmic Fixation Forceps	728
Eichler Bone Files	475	Elschnig Ophthalmic Knives	709
Eicken Antrum Cannulas	652	Elschnig Ophthalmic Scoops	715
Eicken Grasping Forceps Tips	600	Emmet (Sims) Uterine Sounds	900
Eicken Tonsil Needles	593	Emmet Dressing and Cotton Swab Forceps	228
Eiselsberg Needle Holders	249	Emmet Fistula Hooks	902
Eiselsberg-Mathieu Needle Holders	255	Emmet Ligature Needles	284
Eiselsberg Ligature Scissors	53	Emmet Retractor	304
Elevators Bone	461-463	Emmet Trocars	231
" Adson	461	Enderectomy	847
" Alderdyce	463	Enderectomy Strippers	847
" Key	461	Endospecula	943
" Koenig	462	Engl. Model Towel Forceps	214
" McDonald	463	Engle Saw	115
" Obwegesser	462, 463	Enucleation Scissors	48
" Sebileau	462	Enucleators Micro Hardy	751
" Williger	461	Episiotomy Scissors	85, 953
Elevators Buckingham	694	Erhardt Chalazion Forceps	737
Elevators Hanke	590	Erhardt Ear Speculum	682
Elevators Lachrymal Lueneburg	723	Ermold Needle Holders	256
Elevators Larkin	694	Esmarch Anaesthesia Mask	15
Elevators Nerve Root	763, 764	Esmarch Bandage Scissors	106
" Love	764	Esmarch Plaster Knives	114
" Oldberg	764	Ethridge Hysterectomy and Vaginal Forceps	198
" Scoville	764	Evans Dressing Forceps with T/C	159
" Taylor	764	Eves Tonsil Snares	596
Elevators Neuro	761	Excavators Ear Lempert	700
" Cushing	761	Excavators for Nails	125
" Dandy	761	Exenteration Scoops Bunge	718
" Hoen	761	Extension Bows	545, 546
Elevators Periosteal	631	" Bohler	545
" Cottle	631	" Kirschner	545, 546
" Cottle-McKenty	631	" Schwarz	545
" Killian	631	" Steinmann	546
Elevators Septum and Periosteal	627-631	Extractors Comedo	765, 766
" Carter	629	" Hebra	765
" Converse	630	" Katsch	765
" Cottle	629, 630	" Saalfeld	766
" Freer-Ingals	628	" Schamberg	766
" Goldman	630	" Unna	766
" Hajek-Ballenger	628	" Unna-Vidal	765
" Halle	628	Extractors Vascular Varady	848
" Howarth	629	Eye Operating Sets	745, 746
" Joseph	628	Eye Speculum	702, 703
" Joseph-Masing	630	" Agricola	703
" Killian	628	" Arruga	703
" Kistner	628	" Axenfeld	703
" Lange	630	" Barraquer (Colibri)	702
" Masing	629	" Bowman	702
" McKenty	628, 629	" Cook	703
" Pennington	629	" Critchett	702
" Pierce	628	" Goldstein	703
" Roger	629	" Graefe	702
" Yankauer	630	" Guyton-Park	703
Elevators Tonsil	592	" Knapp-Clark	702



# INHALTSVERZEICHNIS INDEX INDEX

	Page		Page
Eye Speculum (cont'd)		Files for Nails	125
" Lancaster	702	Files Rhinoplastic	639-641
" Lister-Burch	702	" Aufricht	639
" Mellinger	703	" Converse	641
" Mellinger-Axenfeld	703	" Cottle	639
" Mellinger-Beard	703	" Fomon	641
" Muller	703	" Gallaher	639-641
" Murdock	703	" Joseph	639, 640
" Park	703	" Lewis	639
" Park-Maumenee	703	" Maltz	639
" Pley	702	" Masing	640
" Sauer	702	" Wiener	640
" Stevenson	703	Fine Ophthalmic Tenotomy Scissors	741
" Weiss	702	Finger Nail Instruments	519
" Ziegler	702	Fink Bi-Prong Marker	705
<b>F</b>		Fink Ophthalmic Retractors	713
Face Protecting Mask	4	Fink-Jameson Ophthalmic Muscular Forceps	735
Faenkel Grasping Forceps Tips	600	Finocchio Bronchus and Gall Duct Clamps	188
Falcao Ophthalmic Suture Forceps	732	Finocchio Needle Holders	247
Falk Ligature Needles	285	Finocchio Needle Holders with T/C	264
Falk Tonsil Needles	593	Finocchio Rib Spreaders	526, 529-532
Farabeuf Bone Holding Forceps	510	Finocchio-Baby-Haight Rib Spreaders	531
Farabeuf Operating Scalpel	25	Finocchio-Infant Rib Spreaders	531
Farabeuf Plaster Breakers	112	Finsen Modif. Tracheal Retractors	608
Farabeuf Raspatories	449	Finsen Retractor	379
Farabeuf Retractor	376	Finsen Tracheal Retractors	608
Farabeuf-Collin Raspatories	449	Fisch Bone Rongeurs	492
Farabeuf-Lambotte Bone Holding Forceps	510	Fisch Dissectors	694
Farr Retractor	395	Fisch Micro Neuro Knives	749
Faulkner Rhinoplastic Sharp Curettes	647	Fisch Retractor	304
Faure Hysterectomy and Vaginal Forceps	197	Fischer Ophthalmic Iris Forceps	726
Faure Peritoneal Clamp Forceps	205	Fischer Tendon Seizing Instrument	430
Faure Uterine Biopsy Forceps	894	Fischer Tonsil Knives	588
Favaloro Vascular Scissors	72	Fischer-Arlt Ophthalmic Iris Forceps	726
Featherstone Mouth Gags	563	Fisher Double Instruments	724
Fehland Atrauma Sigmoid Anastomosis Forceps	792	Fistula Hooks	902
Feilchenfeld Splinter Forceps	147	" Emmet	902
Feldheim Nail Instruments	518	" Simon	902
Ferguson Operating Scissors	61	Fistula Knives	33
Fergusson Angiotribe	180	" Schroeder	33
Fergusson Bone Holding Forceps	507	" Simon	33
Fergusson Gall Stone Scoops	860	" Ulrich	33
Fergusson Haemorrhoidal Forceps	801	Fixation Clamp for Spermatic cord	871
Fergusson Suction Tubes	235	Flat Nose Pliers	549-551
Fergusson Vaginal Speculum	926	Flat Nose Wire Holding Forceps with T/C	551
Fergusson-Ackland Mouth Gags	562	Flat Nose Wire Holding Pliers	550, 551
Ferris-Smith Nasal Polypus Forceps	622	Flat Nose Wire Holding Pliers with T/C	551
Ferris-Smith Punches	662	Flataue Septum Knives	626
Ferris-Smith Tissue Forceps	131	Fletcher (Javerts) Dressing and Sponge Holding Forceps	220
Ferris-Smith Tissue Forceps with T/C	160	Fleurant Trocars	233
Ferris-Smith-Cushing Rongeurs	662	Foerster Dressing and Sponge Holding Forceps	215-217
Ferris-Smith-Kerrison Punches	654-656	Foerster Ophthalmic Capsular Forceps	729
Ferrozel Ligature Conductors	289, 290	Foerster Ophthalmic Iris Forceps	726
Files Bone	473-475	Foerster-Ballenger Gall Duct Forceps	856
" Aufricht	474	Fomon Bone Files	474
" Eichler	475	Fomon Dissecting Scissors	65
" Fomon	474	Fomon Nasal Knives	625
" Gallaher	473	Fomon Retractor	311
" Joseph	473	Fomon Rhinoplastic Chisel	636
" Lewis	474	Fomon Rhinoplastic Files	641
" Miller	473	Fomon Rhinoplastic Hooks	637, 638
" Molt	473	Fomon Rhinoplastic Scissors	646
" Puttl	474	Fomon Tonsil and Nasal Scissors	79
		Footplate Hand Instruments	694, 695
		" House	695



	Page		Page
" Larkin	694	Forceps Atrauma Tissue	842, 843
" Shea	695	" Cooley	843
Forceps Atrauma Anastomosis Dick	789	" De Bakey	842
Forceps Atrauma Cardiovascular	811-837	" Glassman	843
" Atlee	825	Forceps Atrauma Tissue and Organ Holding	770
" Castaneda	826, 829	" Allis	770
" Cooley	832-835	" Collin	770
" Cooley-Glassman	836	" Glassman-Allis	770
" Dale	830	" Glassman-Babcock	770
" Dardik	831	Forceps Atrauma Ureter	872
" De Bakey	811-819	Forceps Atrauma Uro-Tangential	203
" De Bakey-Beck	820	Forceps Atrauma Uterine Polypus and Ovum	888
" De Bakey-Harken	827	Forceps Biopsy for Rectum	804-806
" De Bakey-McQuigg-Mixter	818	" Atrauma	804
" De Bakey-Mixter	817	" Herget	805
" De Bakey-Rumel	817	" Jackson	805
" De Bakey-Semb	816	" Yeoman	804
" Derra	830	Forceps Bone Cutting	484-490
" Derra-Cooley	832	" Bohler	488
" Dick	837	" Cleveland	484
" Dietrich	829	" Cottle	485
" Glover	821	" Horsley	485, 486
" Glover-De Bakey	825	" Kazanjian	485
" Gregory	829	" Killian	488
" Henly	830	" Liston	486, 487, 489
" Lambert-Kay	825	" Liston-Key-Horsley	490
" Lambert-Kay Modif.	825	" Liston-Stille	489
" Lees	826	" Littauer-Liston	485
" Leland-Jones	827	" Markwalder	486
" Morris-De Bakey	820	" McIndoe	488
" Ochsner	829	" Muhling	488
" Parry-Cooley	834	" Niro	485
" Potts	821, 822	" Ruskin-Liston	487
" Rein	828	" Ruskin-Rowland	487
" Satinsky	824	" Semb	490
" Satinsky-De Bakey	824	" Stamm	486
" Weber	828	" Tudor-Edwards	490
" Werthiem	837	Forceps Bone Holding	503-517
Forceps Atrauma Hysterectomy and Vaginal	201-203	" Bircher-Granske	506
" Dick	202	" Bunnel-Howard	517
" Wertheim	202, 203	" Dingmann	505
" Roger	201	" Farabeuf	510
Forceps Atrauma Intestinal and Stomach Clamp	785-789	" Farabeuf-Lambotte	510
" Doyen	785	" Fergusson	507
" Glassman	788	" Frosch	507
" Habere	789	" Haase	503
" Hartmann	787	" Hey-Groves	514
" Kocher	786	" Kern	508
" Mayo-Robson	787	" Kern-Lane	508
" Scudder	787	" Kern-Mini	508
Forceps Atrauma Intestinal Clamp	793	" Lambert-Lowmann	517
" Clamp Brunner	793	" Lambotte	511
" Clamp Kersting	794	" Lane	509
Forceps Atrauma Kidney Pedicle Clamps Guyon	201	" Langenbeck	507
Forceps Atrauma Proctectomy Millin	871	" Lewin	503
Forceps Atrauma Sigmoid Anastomosis	790-793	" Lowmann	516
" De Bakey (Morris Modif.)	793	" Lowmann-Gerster	517
" Fehland	792	" Lowmann-Hoglund	517
" Glassman	790	" Meyer	504
" Heyes	790	" Perham	517, 505
" Kersting	791	" Reill	504
" Morris	793	" Rowe-Harrison	507
" Resano	792	" Self Centering	513
" Veidenheimer	791	" Semb	507
		" Steinhauser	503

	Page		Page
Forceps Bone Holding (cont'd)		Forceps Dissecting (cont'd)	
" Tuffier	510	" Stille-Barraya	771
" Ulrich	512	" Wangenstein	771
" Van Buren	506	Forceps Dissecting and Ligature	181-186
" Verbrugge	512, 515	" Baby-Adson	181
Forceps Bone Screw Holding Lane	544	" Baby-Mixer	184
Forceps Broncho-Esophagoscopy	599-604	" Crafoord	184
" Chevalier-Jackson	599, 602	" Crafoord-Sellors	182
" Jackson	604	" Gemini	183
" Original-Jackson	601, 603	" Johns-Hopkins	184
" Peterson	602	" Kelly	186
" Rntne Hospital	601	" Lawrence	186
Forceps Bronchus	536, 537	" Mini-Gemini	181
" Price Thomas	536	" Mixer	183
" Sarot	536	" Mixer-Baby	184
" Semb	536	" Nissen	181
Forceps Cartilage	428	" Overholt	181
" Bircher	428	" Overholt-Geissendoerfer	185
" Bircher-Ganske	428	" Overholt-Mixer	182
" Herz	428	" Rumel	182
" Jager	428	" Sarot	183
" Weller	428	" Zenker	184
Forceps Catheter Magil	569	Forceps Dressing	128-143, 158-160, 671
Forceps Chalazion	737-738	" Adson	139, 140
" Ayer	737	" Adson with T/C	158
" Cauer	737	" Bonaccolto	140
" Desmarres	738	" Brophy	134
" Erhardt	737	" Cottle	142
" Francis	738	" Cushing	135
" Heath	737	" Cushing with T/C	158, 159
" Hunt	738	" Cushing-Taylor with T/C	159
" Lambert	737	" Davis	141
" Lordan	738	" Duehresen	132
" Snellen	737	" Evans with T/C	159
" Spencer	738	" Fricke	132
" Weaver	738	" Gerald	137
" Weis	738	" Gerald with T/C	160
Forceps Cilia	149, 150	" Gruenwald	142
" Automatic	150	" Gruenwald (Jansen)	142
" Beaupre	150	" Gruenwald with T/C	160
" Beer	150	" Hudson (Ewald)	139
" Bennett	149	" Jansen	671
" Bergh	149	" Lucae	142, 671
" Douglas	149, 150	" Mayo-Russian	141
" Gradle	150	" McIndeo	132
" Graefe	149	" McIndoe with T/C	159
" Henry	150	" Micro-Adson	139
" Jameson-Evans	150	" Ochsner	132
" Kuhne	149	" Potts-Smith	135
" Littauer	149	" Potts-Smith with T/C	159
" Phillips	150	" Ramsay	132
" Saupe	149	" Rochester	138
" Ziegler	149	" Select	131
Forceps Clip Applying	754	" Semken	133
" McKenzie	754	" Semken with T/C	160
" McKenzie Modif.	754	" Standard	138
" Olivecrona-Toennis (Scoville)	754	" Standard with T/C	158
" Raney	754	" Stille	132
Forceps Craniotomy	956	" Taylor	135, 136
Forceps Dilation Vogel	229	" Thorpe	140
Forceps Disimpaction Rowe	585	" Troeltsch	143
Forceps Dissecting	771	" Troeltsch (Wilde)	143, 671
" De Bakey	771	" Wangenstein	134
" Denis-Browne	771	" Wangenstein with T/C	160
" Duval	771	" Waugh	134

	Page		Page
Forceps Dressing (cont'd)		Forceps Grasping	141
" Wilde	143	Forceps Haemorrhoidal	800, 801
Forceps Dressing and Cotton Swab	227, 228	" Atrauma	801
" Emmet	228	" Fergusson	801
" Sauerbruch	228	" Heywood-Smith	800
" Ulrich	227, 228	" Heywood-Smith Modif.	800
Forceps Dressing and Sponge Holding	215-220	" Luer	800
" Bergmann-Foerster	220	" Mc Givney	800
" Bryant	215, 216	" Pratt-Smith	800
" Duplay	217	Forceps Haemostatic	162-178
" Fletcher (Javerts)	220	" Adson	166
" Foerster	215-217	" Allen-Kocher	170
" Gross	216	" Baby-Crile	164
" Heywood-Smith	219	" Baby-Overholt	171
" Kelly	217	" Bainbridge	170
" Lister	215	" Bainbridge-Baby	170
" Maier	219	" Bainbridge-Glassman	169
" Noto	219	" Bengolea	167
" Pelkmann	220	" Birkett	178
" Rampley	217	" Bridge	178
" Sims-Maier	218	" Carrel (Reynolds)	161
Forceps Dressing and Washing	221-226	" Collier-Crile	165
" Bozemann	224	" Crile	164
" Bozemann-Douglas	224	" Dandy	162
" Cheron	225	" Dixon-Lovelace	166
" Collin	225	" Halstead	177
" Duplay	221	" Halstead-Mosquito	162, 163
" Gross	222	" Hartmann	161
" Maier	223	" Hartmann (Baby Mosquito)	160
" Pitha	222	" Heiss	175, 177
" Westermark	226	" Hosemann	178
Forceps Ear Polypus	672, 673	" Jacobson-Micro	163
" Bellucci	672	" Jacobson-Micro	178
" Buck	672	" Jones (Spencer-Wells)	172
" Hartmann	672, 673	" Kelly	164
" Hartmann-Noyes	673	" Kilner-Kelly	165
" Hartmann-Weingartner	673	" Klinikum Berlin	172
" Hartmann-Wullstein	673	" Kocher	171-173, 176
" Littauer	672	" Kocher (Ochsner)	174, 175
" Quire	672	" Kocher-Nippon	177
" Struempel	673	" Kronlein	171
Forceps Embolus Grasping Blake	850	" Leriche	165
Forceps Flat Nose Wire Holding with T/C	551	" Martel	176
Forceps Foreign Body Pitha	874	" Meeker	178
Forceps Gall Duct	856, 857	" Micro-Halstead	162
" Bergstroem	857	" Micro-Hartmann	161
" Doyen	856	" Mod. Klinikum Berlin	172
" Foerster-Ballenger	856	" Mosquito	161-163
" Heywood-Smith	856	" Mosquito-Dandy	162
" Heywood-Smith Modif.	856	" Moynihan	166
" Hosemann	856	" Negus	178
" Nissen	856	" Pean	169, 171, 172
Forceps Gall Stone	858-860	" Pean-Dixon	169
" Blake	859	" Pean-Nippon	170
" Crile	860	" Pratt	169
" Czerny	858	" Providence-Hospital	163
" Desjardins	858	" Rankin-Crile	164
" Mayo-Blake	860	" Rankin-Kelly	164
" Mixer	858	" Roberts	174
" Pelkmann	859	" Rochers-Pean	168
" Stille	859	" Rochester-Carmalt	174
" Tubinger Model	859	" Rugby	178
" Turner-Warwick	860	" Schnidt	177
Forceps Gauze Marschik	591	" Skillman	163
Forceps Genito-Urinary Sachse	876	" Spencer-Wells	172, 173

	Page		Page
Forceps Haemostatic (cont'd)		Forceps Kidney Stone (cont'd)	
" Terrier	165	" Ray	865
" Toennis	176	Forceps Laryngeal	605, 606
" Willet-Martel	176	Forceps Laryngeal Polypus	582, 583
Forceps Hypophyseal	152	" Fraenkel	582, 583
Forceps Hysterectomy	192-203	" Jackson	582
" Ballentine	193	" Jurasz	583
" Dick Atrauma	202	" Lange	583
" Ethridge	198	" Tobold	582
" Faure	197	" Waldenstrom	582
" Glenner	199	Forceps Lewkowitz Lithotomy	872
" Heaney	192	Forceps Lung Grasping	537
" Heaney-Ballentine	193	" Allis	537
" Heaney-Glassman	194	" Babcock	537
" Heaney-Rezek	192	" Duval	537
" Holzach	195	" Williams	537
" Kuffler	194	Forceps Meniscectomy	428
" Long	194	" Bircher	428
" Maingot	194	" Bircher-Ganske	428
" Phaneuf	193	" Herz	428
" Roger Atrauma	201	" Jager	428
" Segond	196	" Weller	428
" Segond-Landau	196	Forceps Micro	153-157
" Walzi	193	" Brock	157
" Werthiem	195-200	" Gerald	154
" Werthiem Atrauma	202, 203	" Gomel	154
" Werthiem-Cullen	199	" Jacobson	157
" Wiener Model	193	" Jacobson-Adson	156
Forceps Intestinal and Stomach Clamp	780-784	" Yasargil	153, 157
" Abadie	783	Forceps Micro Ear	674-676
" Babere	782	" Mini McGee Alligator	674
" Benson	783	" Wullstein-Blakesley	675
" De Martel-Wolfson	784	Forceps Micro Wire Closure	678, 679
" Kleinschmidt	783	" Greven	678
" Lane	781	" Juers	678
" Lloyd-Davis	784	" McGee	678
" Partsch	780	" Schuknecht	678
" Payr	780	Forceps Nail Penner	519
" Payr-Baby	780	Forceps Nail Splitting	518
" Roosevel	782	Forceps Nasal Polypus	622
" Stetten	783	" Ferris-Smith	622
" Stone	784	" Kofler	622
Forceps Intestinal Clamp	772-777, 780-789	" Takahashi	622
" Allen	772	" Watson-Williams	622
" Baby-Kocher	772	" Weil	622
" Bainbridge	772	Forceps Nasal Polypus and Cutting	621-624
" Brunner	777	" Blakesley	621
" Doyen	772, 773	" Blakesley (Lewis)	621
" Hartmann	772	" Bruenings	621
" Kocher	774, 775	" Luc	621
" Mayo-Robson	773	Forceps Nasal Polypus and Septum	619-622
" Mikulicz	776	" Craig	620
" Moynihan	777	" Craig-Dominick	620
" Parker-Kerr	776	" Gruenwald (Jansen)	620
" Scudder	777	" Hartmann	619
Forceps Kidney Elevating	867	" Heymann	620
" Collin	867	" Heymann-Knight	619
" Dartigues	867	" Killian	619
" Kocher	867	" Knight	619
Forceps Kidney Pedical Clamp	868	" Littauer	619
" Werthiem Kidney	868	" Lubet-Barbon	619
" Werthiem-Cullen Kidney	868	" Noyes	620
Forceps Kidney Stone	864, 865	" Quire	620
" Heiming	864	" Tilley	620
" Randall	864, 865	" Troeltsch	620

	Page		Page
Forceps Nasal Polypus and Septum (cont'd)		Forceps Ophthalmic Expression (cont'd)	
" Westmacott	619	" Knapp	736
Forceps Nephrostomy Elsasser	866	" Prince	736
Forceps Neuro	751, 752	Forceps Ophthalmic Fixation	727-729, 736
Forceps Obstetrical	958-964	" Barraquer	728
" Anderson	962	" Barraquer (Colibri)	727
" Bailey-Williamson	961	" Barraquer-Katzin	727
" Barens	962	" Barraquer-Katzin (Colibri)	727
" Barnes-Neville	964	" Barraquer-Llovera	728
" Barton	962	" Castroviejo	727
" Boerma	958	" Castroviejo-Colibri	728
" De Lee	961	" Clark-Verhoeff	729
" Demelis	963	" Dermor-Pierse	736
" Deweys	964	" Dermor-Pierse (Colibri)	736
" Elliot	963	" Elschmig	728
" Haig-Fergusson	963	" Graefe	728
" Hawks-Dennen	961	" Green	728
" K. N. Dass	962	" Kirby-Artur	728
" Kielland	960	" Maumenee-Colibri	728
" Kielland-Luikart	960	" O'Brein	729
" Luikart	960	" Pierse	728
" Mc Lean	960	" Pierse-Colibri	728
" Mc Lean-Luikart	961	" Sauer	728
" Mc Lean-Rucker-Luikart	961	" Troutman (Colibri)	727
" Milne-Murray	963	" Verhoeff	729
" Murless	960	" Waldau	729
" Naegele	958	" Willard-Colibri	729
" Piper	959	Forceps Ophthalmic	725-738
" Simpson	958, 963	" Iris	725-727
" Simpson-Braun	959	" Iris Bishop-Harman	725
" Simpson-Luikart	959	" Iris Chandler	727
" Tarnier	964	" Iris Elliot	726
" Wrigley	958	" Iris Fischer	726
Forceps Ophthalmic Advancement	736	" Iris Fischer-Arlt	726
" Barens	736	" Iris Foerster	726
" Elschmig	736	" Iris Fuchs	727
" Worth	736	" Iris Gill	727
Forceps Ophthalmic Anterior Chamber Barraquer	735	" Iris Gill-Hess	727
Forceps Ophthalmic Capsular	729-732	" Iris Graefe	725
" Arruga	730	" Iris Hess	726
" Arruga-Nizetic	730	" Iris Mod. Bonn	726, 727
" Barraquer	731	" Iris Panas	726
" Binkhorst	732	" Iris Stevens	725
" Castroviejo	730	Forceps Ophthalmic Muscular	734, 735
" Choyce	731	" Berke	735
" Clayman	731	" Blascovics	735
" Elschmig	730	" Fink-Jameson	735
" Foerster	729	" Jameson	734
" Fuchs	730	" Prince	735
" Galin	731	" Sattler	735
" Gill-Arruga	729	Forceps Ophthalmic Radial Keratomy	737
" Gill-Fuchs	729	" Arrowsmith	737
" Green	731	" Bores	737
" Hess	730	" Kremer	737
" Hirschmann	732	" Rubman-Bores	737
" Kalt	730	Forceps Ophthalmic Skeleton Kuhnt	736
" McPherson	731	Forceps Ophthalmic Strabismus	733, 734
" Pley	730	" Barraquer Modif.	733
" Safar	731	" Bonaccolto	733, 734
" Schweigger	729	" Bonn	733
" Shepard	731	" Dastoor	734
" Stock	729	" McCullough	733
" Swiss Mod.	729	" McPherson	734
" Terson	729, 731	" Mod. Tubingen	733
Forceps Ophthalmic Expression	736	" Nugent	733

	Page		Page
Forceps Ophthalmic Strabismus (cont'd)		Forceps Special (cont'd)	
" Paufique	734	" De Bakey	152
" Schaaf	734	" Heifetz	151
" Truthman-Rectus	734	" Hunt	151
" Tubingen	733	" Samii	152
Forceps Ophthalmic Suture	732, 733	" Tying	152
" Alabama-University	732	" Yasargil	151
" Castroviejo	733	" Yasargil-Samii	151
" Dastoor	733	Forceps Splinter	144-148
" Falcao	732	" Arthur	148
" Girad	733	" Carmalt	145
" Guist	732	" Droeber	146
" Kronfeld	732	" Feilchenfeld	147
" Kronfeld (Panas)	732	" Hunter	145, 146
" Moorfield	732	" Peet	147
Forceps Ophthalmic Tissue	732	" Physician	148
" Lester	732	" Ralk	147
" Schmidt-Rimpler	732	" Ralk (Virtus)	147
Forceps Peritoneal Clamp	204-206	" Schaaf	146
" Baby-Mikulicz	204	" Stieglitz	148
" Faure	205	" Stieglitz (Williams)	148
" Mikulicz	204-206	" Vanguard	147
" Schindler	206	" Walter	145
Forceps Placenta and Ovum	944-950	Forceps Steinhauser	669, 670
" Corey	950	Forceps Sterilizing	965-968, 973
" Kelly	948	" Cheattle	965, 966
" Kranz	950	" Collin	966
" Lewkowitz	949	" Davis	968
" Mc Clintock	948	" London-Hospital	965
" Saenger	949	" Pye-Smith (Harrison)	966
" Winter	944-948	" Rogge	965
Forceps Proctectomy	871	" Sauerbruch	967
" Millin	871	" Ulleval	965
Forceps Punch	597	Forceps Stomach Clamp	778-789
" Hartmann	597	" Moynihan	779
" Ruault	597	" Scudder	778
" Ruault-Collin	597	Forceps Suture	292, 293
" Schmeden	597	" Braith-Waite	293
Forceps Puncturing	952	" Child	292
" Herff	952	" Collin	293
" Iowa	952	" Heath	293
Forceps Razor Blade Removing	24	" Hegenbarth	292
Forceps Reamer Adson	540	" Lange	292
Forceps Rhinoplastic	642-645	" Michel	292, 293
" Asch	642	" Michel Modif.	293
" Cottle	644	" Ochsner	292
" Cottle-Masing	643	" Wachenfeldt	292
" Cottle-Walsham	643	Forceps Tendon Seizing	429-432
" Fox	644, 645	" Brand	429, 432
" Guillen	644	" Carroll	432
" Hinderer	644	" Herz	431
" Masing	644	" Jackson	432
" Ogura	644	" Jager	431
" Rubin	642	" Kleinert-Kutz	431
" Tschoepe	643	" Steinmann	429
" Walsham	643	Forceps Tissue	128-143, 158-160
" Walsham (Universal)	643	" Adlerkreutz	136
Forceps Scalp Flap	951	" Adson	139, 140
" Gauss	951	" Adson with T/C	158
" Green-Armytage	951	" Adson-Brown	139, 140
" Willett	951	" Adson-Brown with T/C	158
Forceps Septum Compression	619-620	" Adson-Graefe	140
Forceps Sinus Mackay	606	" Boney	131
Forceps Special	151, 152	" Bonney with T/C	160
" Adson	152	" Brophy	134

	Page		Page
Forceps Tissue (cont'd)			
" Brown	138	" Tuffier	179, 767
" Buehressen	138	" Williams	768
" Collin Duval	141	Forceps Tongue Holding	578, 579
" Cushing	135	" Collin	578
" De Bakey with T/C	159	" Guy	578
" Durante	138	" Heywood-Smith	579
" Duval	138	" Heywood-Smith Modif.	579
" Ferris-Smith	131	" Loebker	579
" Ferris-Smith with T/C	160	" Mathieu	579
" Gerald	137	" Stille	579
" Gillies	132	" Young	579
" Gillies with T/C	159	Forceps Tonsil Seizing	594, 595
" Gruenwald	142	" Ballenger	594
" Gruenwald (Jansen)	142	" Blohmke	595
" Hudson (Ewald)	139	" Colver	594
" Koenig	134	" Leineweber	595
" Lane	137	" Marschik-Krone	594
" Lexer	137	" McWorther-Lothrop	595
" Lucae	142	" Muck	595
" Micro-Adson	139	" Museux	595
" Micro-Adson-Biemer	140	" Schnidt	594
" Nelson	141	" Thilenius	595
" Oehler with T/C	158	" Tivnen-Tyding	595
" Potts-Smith	135	" White	594
" Ramsay	132	Forceps Towel	210-214
" Rooke	132	" Backhaus	211
" Russian Model	138	" Backhaus-Kocher	211
" Select	131, 132	" Bernhard	213
" Semken	133	" Doyen	214
" Semken with T/C	160	" Engl. Model	214
" Skene	136	" Hoff	211
" Skinner with T/C	160	" Jones	214
" Stille	132	" Lane	213
" Stille-Barraya	134	" Lorna	212
" Stone	137	" Moynihan	213
" Strassburger Mod.	133	" Ombredanne (Jackhson)	212
" Taylor	136	" Peers-Bertram	212
" Treaves	133	" Robin	212
" Troeltsch (Wilde)	143	" Roeder	212
" Waugh	134	" Schaedel	214
" Williams with T/C	159	" Tohoku	212
" with T/C	158-160	Forceps Transplant	721
Forceps Tissue and Organ Holding	179, 180, 767-770	" Berens	721
" Allis	767	" Paton	721
" Allis-Adair	767	Forceps Tubal Seizing	899
" Allis-Babcock	769	Forceps Ureter Calculus Lurz	866
" Allis-Baby	767	Forceps Uterine Biopsy	891-898
" Allis-Niro	768	" Alexander	891
" Babcock	769	" Appendorf	895, 898
" Babcock with T/C	770	" Baby-Tischler	898
" Babcock-Baby	769	" Burke	897, 898
" Boys-Allis	767	" Douay	896
" Chaput	179, 767	" Faure	894
" Collin	179	" Gaylor	893
" Duval	769	" Gellhorn	893
" Duval with T/C	770	" Kevorkian	893, 898
" Duval-Collin	769	" Kevorkian-Pacific	897, 898
" Judd-Allis	768	" Krause	896
" Lane	769	" Mini-Townsend	898
" Lockwood	768	" Scheinmann	896
" Lockwood-Allis	768	" Schubert	891, 892
" Lovelace	768	" Schumacher	892, 895, 896
" Pennington	179	" Schumacher-Van Doren	892
" Thoms-Allis	768	" Seidl	894
		" Swiss Mod.	896







# INHALTSVERZEICHNIS INDEX INDEX

	Page		Page
Gall Duct Forceps (cont'd)		Gill Ophthalmic Knives	709
" Foerster-Ballenger	856	Gill-Arruga Ophthalmic Capsular Forceps	729
" Heywood-Smith	856	Gill-Fuchs Ophthalmic Capsular Forceps	729
" Heywood-Smith Modif.	856	Gill-Hess Ophthalmic Iris Forceps	727
" Hosemann	856	Gillies Needle Holders	249
" Nissen	856	Gillies Needle Holders with T/C	265
Gall Stone Catchers	860	Gillies Neuro Hooklets	765
Gall Stone Forceps	858-860	Gillies Retractor	304
" Blake	859	Gillies Tissue Forceps	132
" Crile	860	Gillies Tissue Forceps with T/C	159
" Czerny	858	Gillies-Slim Needle Holders	249
" Desjardins	858	Gillies-Slim Needle Holders with T/C	265
" Mayo-Blake	860	Gil-Vernet Retractor	299
" Mixer	858	Girad Ophthalmic Suture Forceps	733
" Pelkmann	859	Girard Swan Ophthalmic Knives	710
" Stille	859	Gland Spoons Cushing	761
" Tubinger Model	859	Glassman Atrauma Intestinal and Stomach Clamp Forceps	788
" Turner-Warwick	860	Glassman Atrauma Sigmoid Anastomosis Forceps	790
Gall Stone Scoops	860-862	Glassman Atrauma Tissue Forceps	843
" Desjardins	861	Glassman-Allis Atrauma Tissue and Organ Holding Forceps	770
" Fergusson	860	Glassman-Babcock Atrauma Tissue and Organ Holding Forceps	770
" Luer-Koerte	861	Glennner Hysterectomy and Vaginal Forceps	199
" Mayo	860, 862	Glover Atrauma Bulldog Clamps	808
" Moore	862	Glover Atrauma Cardiovascular Forceps	821
Gallaher Bone Files	473	Glover-De Bakey Atrauma Cardiovascular Forceps	825
Gallaher Rhinoplastic Files	639-641	Gluck Rib Shears	520
Galt Trephine	115	Goelet Retractor	352
Gardiner-Brown Tuning Forks	686	Goldman Septum and Periosteal Elevators	630
Gardner-Brown Ear Loops	697	Goldman-Fox Scissors	45
Gauss Scalp Flap Forceps	951	Goldman-Fox Scissors with T/C	87
Gauze Cloth Scissors	108	Goldstein Eye Speculum	703
Gauze Dispenser	989	Gomel Micro Forceps	154
Gauze Forceps Marschik	591	Gomel Micro Needle Holders	274
Gauze Packers	591, 901	Gomel Suction Tubes	237
" Lewis	591	Good Tonsil and Nasal Scissors	80
" Luniatschek	591	Goodell Uterine Dilators	906
Gaylor Uterine Biopsy Forceps	893	Goodyear Tonsil Retractors	591
Geiger Bone Rongeurs	498	Gordon Uterine Tenaculum Forceps	879
Gellhorn Uterine Biopsy Forceps	893	Gorney Dissecting Scissors	65
Gelpi Retractor	397	Gorney Suction Tubes	239
Gelpi Vaginal Retractors	942	Gosset Abdominal Retractor	408
Gelpi-Baby Retractor	396	Gosset Bladder Retractor	416
Gelpi-Loktite Retractor	396, 397	Gouges Bone	433-447
Gelpi-Seiletz Retractor	396	" Alexander	439
Gemini Dissecting and Ligature Forceps	183	" Bishop	433, 434
Genell Biopsy Curettes	908	" Bruenings (Lucas)	436
Genito-Urinary Instruments	871-877	" Bruns	441
Genito-Urinary Retractors	871, 872	" Buck-Gramcko	433
" Stockmann	871	" Freer	435
" Strauss	872	" Hibbs	437
" Young	871	" Kramer	437
Genito-Urinary Sets	877	" Lexer	444, 447
Gerald Dressing Forceps	137	" Lucas	438
Gerald Dressing Forceps with T/C	160	" Mannerfelt	435
Gerald Micro Forceps	154	" McEwen	440
Gerald Tissue Forceps	137	" Mini-Lexer	443
Gerster Traction Bar	516	" Murphy	438
Gerzog Mallet	421	" Schwartz	433
Gerzog Paracentesis Needles	689	" Sheehan	435
Gerzog-Sexton Paracentesis Needles	691	" Smith-Petersen	442
Giertz-Stille Rib Shears	521	" Stille	440
Gifford-Jansen Retractor	381	" Thies	437
Gigli (Olivecrona) Wire Saws	119, 754	" U. S. Army	439
Gigli Wire Saw Handle	119, 754	" Wagner	446
Gill Ophthalmic Iris Forceps	727	" Walter	441



# INHALTSVERZEICHNIS INDEX INDEX

	Page		Page
Gouges Bone (cont'd)		Gruenwald Nasal Cutting Forceps	624
" West	435	Gruenwald Tissue Forceps	142
" Zielke	446	Guilen Cannula	653
Gouges Lachrymal Sac West	723	Guillen Rhinoplastic Forceps	644
Gouges Ophthalmic	710	Guillen Rhinoplastic Hammers	647
" Dix	711	Guist Ophthalmic Suture Forceps	732
" Kuhnt	710	Guleke Bone Rongeurs	496
" Meyer	710	Gum Scissors	86
" Walton	710	Gusberg Biopsy Curettes	908
" Walton (Todd)	710	Guthrie Ophthalmic Hooks	712
Gouges Rhinoplastic	633	Guthrie Ophthalmic Knives	709
" Freer	633	Guthrie Retractor	303
" Killian	633	Guttman Vaginal Speculum	926
" Killian-Claus	633	Guy Plaster Shears	111
Gourdet Uterine Scoops	919	Guy Tongue Holding Forceps	578
Gradle Cilia Forceps	150	Guyon Atrauma Kidney Pedicle Clamps	201
Graduated Measures	983	Guyon Catheter Guide	873
Graefe Chalazion Curettes	717	Guyon Dilators	874
Graefe Cilia Forceps	149	Guyon Genito-Urinary Sets	877
Graefe Eye Speculum	702	Guyon Kidney Pedicle Clamps	190, 191
Graefe Ophthalmic Cystotomes	713	Guyton-Lundsgaard Ophthalmic Knives	709
Graefe Ophthalmic Fixation Forceps	728	Guyton-Park Eye Speculum	703
Graefe Ophthalmic Hooklets	712	Gynecological Scissors	81-85
Graefe Ophthalmic Hooks	712		
Graefe Ophthalmic Iris Forceps	725		
Graefe Ophthalmic Knives	706-709		
Graefe Ophthalmic Scoops	715		
Graefe Retractor	303, 307		
Graefe-Arruga Ophthalmic Knives	706		
Graefe-Standard Trocars	230		
Graham Dura Hooks	759		
Grasping Forceps	141		
Grasping Forceps Tips	600		
" Bruenings	600		
" Eicken	600		
" Faenkel	600		
" Lange	600		
" Scheinmann	600		
" Seiffert	600		
Grave Special Vaginal Speculum	921		
Graves Modif. Vaginal Speculum	920		
Graves Vaginal Speculum	920, 921		
Gray Bronchus and Gall Duct Clamps	189		
Green Double Instruments	724		
Green Ophthalmic Capsular Forceps	731		
Green Ophthalmic Chisels	710		
Green Ophthalmic Fixation Forceps	728		
Green Ophthalmic Hooklets	712		
Green-Armytage Scalp Flap Forceps	951		
Greene Retractor	341		
Greene Uterine Curettes	912		
Gregory Atrauma Cardiovascular Forceps	829		
Gregory-Soft Atrauma Bulldog Clamps	809		
Greven Micro Wire Closure Forceps	678		
Grieshaber Ophthalmic Trephines	721		
Groenholm Lid Retractors	704		
Gross Dressing and Sponge Holding Forceps	216		
Gross Dressing and Washing Forceps	222		
Gross Ear Loops	697		
Gruber Ear Speculum	681		
Gruenwald (Jansen) Dressing Forceps	142		
Gruenwald (Jansen) Nasal Polypus and Septum Forceps	620		
Gruenwald (Jansen) Tissue Forceps	142		
Gruenwald Dressing Forceps	142		
Gruenwald Dressing Forceps with T/C	160		
		<b>H</b>	
		H. G. Muller Uterine Tenaculum Forceps with T/C	884
		Haab Ophthalmic Knives	709
		Haase Bone Holding Forceps	503
		Haase Tampers	448
		Haberer Atrauma Intestinal and Stomach Clamp Forceps	789
		Haberer Retractor	374
		Haberer Spatulas	374
		Haeggstroem Trocars	233
		Haemorrhoidal Forceps	800, 801
		" Atrauma	801
		" Fergusson	801
		" Heywood-Smith	800
		" Heywood-Smith Modif.	800
		" Luer	800
		" Mc Givney	800
		" Pratt-Smith	800
		Haemorrhoidal Ligators	802
		" Levy	802
		" McGivney Modif.	803
		" Rudd	803
		Haemostatic Forceps	162-178
		" Adson	166
		" Allen-Kocher	170
		" Baby-Crile	164
		" Baby-Overholt	171
		" Bainbridge	170
		" Bainbridge-Baby	170
		" Bainbridge-Glasssman	169
		" Bengolea	167
		" Birkett	178
		" Bridge	178
		" Carrel (Reynolds)	161
		" Collier-Crile	165
		" Crile	164
		" Dandy	162
		" Dixon-Lovelace	166
		" Halstead	177
		" Halstead-Mosquito	162, 163
		" Hartmann	161

	Page		Page
" Hartmann (Baby Mosquito)	160	Halle Septum and Periosteal Elevators	628
" Heiss	175, 177	Halle Vascular Dissectors	848
" Hosemann	178	Halle Vascular Spatuls	848
" Jacobson-Micro	163, 178	Halnaso Diagnostic Set	14
" Jones (Spencer-Wells)	172	Halsey Needle Holders	241
" Kelly	164	Halsey Needle Holders with T/C	258
" Kilner-Kelly	165	Halstead Haemostatic Forceps	177
" Klinikum Berlin	172	Halstead Needle Holders	246
" Kocher	171-173, 176	Halstead-Mosquito Haemostatic Forceps	162, 163
" Kocher (Ochsner)	174, 175	Hammers Rhinoplastic	647
" Kocher-Nippon	177	" Cottle	647
" Kronlein	171	" Guillen	647
" Leriche	165	" Quisling	647
" Martel	176	Hand Drills	538-540
" Meeker	178	" Bunnel	539
" Micro-Halstead	162	" Hudson	540
" Micro-Hartmann	161	" Moore	539
" Mod. Klinikum Berlin	172	" Perthes	540
" Mosquito	161-163	" Ralk	539
" Mosquito-Dandy	162	" Stille	538
" Moynihan	166	" Stille-Sherman	538
" Negus	178	Handle for Broncho-Esophagoscopy Forceps	599
" Pean	169	" Bruenings	599
" Pean	171, 172	" Huber	599
" Pean-Dixon	169	" Yeoman	599
" Pean-Nippon	170	Handle for Gigli Wire Saw	119, 754
" Pratt	169	Handles for Laryngeal Mirrors	580, 581
" Providence-Hospital	163	Handles for Laryngoscopes	556, 557
" Rankin-Crile	164	Handte Retractor	301
" Rankin-Kelly	164	Hank Uterine Dilators	905
" Roberts	174	Hanke Elevators	590
" Rochers-Pean	168	Hardy Micro Dissectors	751
" Rochester-Carmalt	174	Hardy Micro Enucleators	751
" Rugby	178	Harken Vena Cava Clamps	853
" Schnidt	177	Harms Trabecular Probes	719
" Skillman	163	Harrington Retractor	343, 362, 363
" Spencer-Wells	172, 173	Harrington-Baby Retractor	362
" Terrier	165	Harrington-Pemberton Retractor	362
" Toennis	176	Harris Tonsil Knives	589
" Willet-Martel	176	Hartert (Stereo) Stethoscope	7
Haemostats Tonsil	596	Hartmann (Baby Mosquito) Haemostatic Forceps	160
" Crown	596	Hartmann Aspiration Tubes	573
" Vetter-Ulrich	596	Hartmann Atrauma Intestinal and Stomach Clamp Forceps	787
Hagedorn Needle Holders	257	Hartmann Cannula	653
Hagedorn Trocars	231	Hartmann Ear Catheters	671
Haglund-Stille Plaster Shears	111	Hartmann Ear Hooks	698
Haglund-Stille Plaster Spreaders	113	Hartmann Ear Polypus Forceps	672, 673
Haig-Fergusson Obstetrical Forceps	963	Hartmann Ear Speculum	680
Haight Rib Spreaders	525	Hartmann Haemostatic Forceps	161
Haitz Canaliculus Punches	722	Hartmann Intestinal Clamp Forceps	772
Hajek Cannula	653	Hartmann Intestinal Cutting Forceps	623, 624
Hajek Mallet	420	Hartmann Nasal Polypus and Septum Forceps	619
Hajek Probes	857	Hartmann Nasal Speculum	613
Hajek-Ballenger Septum and Periosteal Elevators	628	Hartmann Punch Forceps	597
Hajek-Claus Nasal Cutting Forceps	623	Hartmann Tongue Depressors	570
Hajek-Kofler PUNCHES	657, 658	Hartmann Tonsil Elevators	592
Hakansson Bone Rongeurs	495	Hartmann Tuning Forks	683, 684, 686, 687
Hakie Sterilizing Racks	970	Hartmann-Halle Nasal Speculum	613
Halle Bone Curettes	478	Hartmann-Noyes Ear Polypus Forceps	673
Halle Dura Knife	32	Hartmann-Weingartner Ear Polypus Forceps	673
Halle Nasal Knives	626	Hartmann-Wullstein Ear Polypus Forceps	673
Halle Neuro Knives	762	Harvey Jackson Retractor	391
Halle Operating Scalpel	29	Harvey Ligature Scissors	53
Halle Raspatories	452	Hawks-Dennen Obstetrical Forceps	961
		Head Bands	3

	Page		Page
Head Mirrors	1-3	Heywood-Smith Modif. Haemorrhoidal Forceps	800
Heaney Hysterectomy Forceps	192	Heywood-Smith Modif. Tongue Holding Forceps	579
Heaney Needle Holders	248	Heywood-Smith Tongue Holding Forceps	579
Heaney Retractor	338	Heywood-Smith Uterine Polypus and Ovum Forceps	888
Heaney Uterine Curettes	913	Hibbs Blades for Laminectomy Retractors	419
Heaney Vaginal Retractors	942	Hibbs Bone Chisels	436
Heaney-Ballentine Hysterectomy Forceps	193	Hibbs Bone Gouges	437
Heaney-Glassman Hysterectomy Forceps	194	Hibbs Bone Osteotomes	436, 437
Heaney-Rezek Hysterectomy Forceps	192	Hibbs Retractor	336
Heath Chalazion Curettes	718	Hildebrandt Uterine Catheters	916
Heath Chalazion Forceps	737	Hinderer Rhinoplastic Forceps	644
Heath Ligature Scissors	53	Hinged Back Amputation Saws	116
Heath Mallet	423	Hirschmann Ophthalmic Capsular Forceps	732
Heath Suture Forceps	293	Hirschmann Ophthalmic Hooks	712
Hebra Chalazion Curettes	717	Hirschmann Rectal Specula	798
Hebra Comedo Extractors	765	Hirth Catheter	865
Hegar Needle Holders	241, 244	Hodlick Needle Holders	243
Hegar Needle Holders with T/C	261	Hoehn Neuro Elevators	761
Hegar Uterine Dilators	903, 904	Hoehn Raspatories	450
Hegar-Baumgartner Needle Holders	242	Hoehn Retractor	400
Hegar-Baumgartner Needle Holders with T/C	258	Hoesel Needle Holders	256
Hegar-Vascular Needle Holders with T/C	263	Hoesel Needle Holders with T/C	267
Hegenbarth Suture Forceps	292	Hoesel Retractor	346
Heifetz Brain Spatulas	763	Hofer Tonsil Retractors	591
Heifetz Tumor and Vessel Forceps	151	Hoff Towel Forceps	211
Heiming Kidney Stone Forceps	864	Hoffmann Tubing Clamps	969
Heiss Haemostatic Forceps	175, 177	Hofmeister Ligature Conductors	289
Heister Mouth Gags	563	Hohmann Bone Levers	467, 468
Helferich-Bier Amputation Saws	118	Hohmann-Aldinger Bone Levers	471
Heller Papillotomy Forceps	863	Hoke Bone Osteotomes	436
Hemingway Bone Curettes	476	Holders Caustic	901
Henley Retractor	388	Holders Cotton	901
Henly Atrauma Cardiovascular Forceps	830	"    Playfair	901
Henner (Lempert) Retractor	381	"    Sims	901
Henning Plaster Spreaders	113	Holders Swab for Rectum Norwood	806, 807
Henrotin Uterine Tenaculum Forceps	885	Holmagren Ear Speculum	682
Henry Cilia Forceps	150	Holmann Retractor	368
Henton Suture Instruments	291	Holt Tubing Clamps	969
Henton Tonsil Needles	592	Holth Canalliculus Punches	722
Hepp/Scheidel Tubal Seizing Forceps	141	Holth Ophthalmic Hooks	712
Hepp-Scheidel Suction Tubes	237	Holz Hooklets	699
Hercules Plaster Shears	111	Holzbach Retractor	403
Herff Puncturing Forceps	952	Holzbach Hysterectomy Forceps	195
Herget Biopsy Forceps for Rectum	805	Hooklets	698, 699
Herrick Kidney Pedicle Clamps	190	"    Allport	698
Hertzler Abdominal Retractor	406	"    Day	699
Hertzler Rib Spreaders	527	"    Holz	699
Herz Meniscectomy Forceps	428	"    Jansen	699
Herz Tendon Seizing Forceps	431	"    Jansen-Newhart	699
Hess Ophthalmic Capsular Forceps	730	"    Lucae	699
Hess Ophthalmic Iris Forceps	726	Hooklets for Neurosurgery	765
Hess Ophthalmic Scoops	715	"    Gillies	765
Hessberg Ligature Needles	744	"    Kiener	765
Heyes Atrauma Sigmoid Anastomosis Forceps	790	Hooklets for Ophthalmology	712
Hey-Groves Bone Holding Forceps	514	"    Arruga	712
Heymann Nasal Knives	625	"    Culler	712
Heymann Nasal Polypus and Septum Forceps	620	"    Graefe	712
Heymann Nasal Scissors	618	"    Green	712
Heymann Rhinoplastic Scissors	646	"    Jameson	712
Heymann Tonsil and Nasal Scissors	79	"    Smith	712
Heymann-Knight Nasal Polypus and Septum Forceps	619	"    Stevens	712
Heywood-Smith Dressing and Sponge Holding Forceps	219	Hooklets Stacke	699
Heywood-Smith Gall Duct Forceps	856	Hooklets Troeltsch	699
Heywood-Smith Haemorrhoidal Forceps	800	Hooklets Wullstein	699
Heywood-Smith Modif. Gall Duct Forceps	856	Hooklets Yankauer	699

	Page		Page
Hooklets Yankauer-Jansen	699	Hufnagel Needle Holders with T/C	262
Hooks Decapitating	951	Humby Retractor	306
" Braun	951	Hume Atrauma Aortic Clamps	841
" Smellie	951	Hunt Chalazion Forceps	738
Hooks Dura	759	Hunt Tumor and Vessel Forceps	151
" Adson	759	Hunter Splinter Forceps	145, 146
" Cushing	759	Hurd Dissectors	590
" Graham	759	Hurd Tonsil Needles	593
" Lahey	759	Hyllin Raspatories	457
" Sachs	759	Hypodermic and Biopsy Needles	240
" Toennis	759	" Dattner	240
Hooks Ear	693	" Klima-Rosegger	240
" Barbara	693	" Strauss	240
" Hartmann	698	Hypophyseal Forceps	152
" McGee	693	Hysterectomy and Vaginal Forceps	192-203
Hooks Fistula	902	" Dick Atrauma	202
" Emmet	902	" Ethridge	198
" Simon	902	" Faure	197
Hooks Galea Yasargil	756	" Glenner	199
Hooks Nerve	759, 760, 849	" Werthiem	197-200
" Crile	849	" Werthiem Atrauma	202, 203
" Dandy	759	" Wertheim-Cullen	199
" Krayenbuhl	749	Hysterectomy Forceps	192-203
" Scoville	760	" Ballentine	193
" Smithwick	759, 760	" Heaney	192
Hooks Ophthalmic	712	" Heaney-Ballentine	193
" Berens	712	" Heaney-Glassman	194
" Graefe	712	" Heaney-Rezek	192
" Guthrie	712	" Holzbach	195
" Hirschmann	712	" Kuffler	194
" Holth	712	" Long	194
" Mod. Bonn	712	" Maingot	194
" Mod. Tübingen	712	" Phaneuf	193
" O'Conner	712	" Segond	196
" Panas	712	" Segond-Landau	196
" Stevens	712	" Walzl	193
" Tyrel	712	" Werthiem	195-200
" Wiener	712	" Wiener Model	193
Hooks Rhinoplastic	637, 638		
" Cottle	637	I	
" Cottle-Neivert	637	Illic Nail Nippers	121
" Fomon	637, 638	Inge Retractor	401
" Freer	638	Ingersoll Adenoid Curettes	649
" Joseph	638	Instrument Boxes	985, 986
" Neivert	637	Instrument Containers	979
Hopfner Vena Cava Clamps	852	Instruments for Cranial Opening	754, 755
Hopkins Plaster Knives	114	Instruments for Hip Nailing	544
Horsley Bone Cutters	485, 486	Instrument Storing Trays	984
Horsley Dura Dissectors	757	Interchangeable Tubes for Broncho-Esophagoscopy Forceps	599
Hosemann Gall Duct Forceps	856	Intestinal and Stomach Clamp Atrauma Forceps	785-789
Hosemann Haemostatic Forceps	178	" Doyen	785
House Ear Curettes	697	" Glassman	788
House Footplate Hand Instruments	695	" Habere	789
House Measuring Rods	694	" Hartmann	787
House-Dieter Micro Introduction Instruments	679	" Kocher	786
Houzal Abdominal Retractor	404	" Mayo-Robson	787
Howarth Raspatories	454	" Scudder	787
Howarth Septum and Periosteal Elevators	629	Intestinal and Stomach Clamp Forceps	780-784
Howell Retractor	326	" Abadie	783
Hryntschak Bladder Retractors	869	" Baberer	782
Huber Handle for Broncho-Esophagoscopy Forceps	599	" Benson	783
Hudson (Ewald) Dressing Forceps	139	" De Martel-Wolfson	784
Hudson (Ewald) Tissue Forceps	139	" Kleinschmidt	783
Hudson Hand Drills	540	" Lane	781
Hufnagel Needle Holders	245		



# INHALTSVERZEICHNIS INDEX INDEX

	Page		Page
Intestinal and Stomach Clamp Forceps (cont'd)			
" Lloyd-Davis	784	Jaeger Lid Plate	705
" Partsch	780	Jaeger Ophthalmic Keratomes	707
" Payr	780	Jaeger Ophthalmic Knives	707
" Payr-Baby	780	Jaeger Retractor	305
" Roosevelt	782	Jaeger-Grieshaber Ophthalmic Keratomes	707
" Stetten	783	Jaeger-Grieshaber Ophthalmic Knives	707
" Stone	784	Jager Meniscectomy Forceps	428
Intestinal Clamp Atrauma Forceps	793, 794	Jager Tendon Seizing Forceps	431
" Brunner	793	Jameson Ophthalmic Hooklets	712
" Kersting	794	Jameson Ophthalmic Muscular Forceps	734
Intestinal Clamp Forceps	772-777, 780-789	Jameson Scissors	47
" Allen	772	Jameson-Evans Cilia Forceps	150
" Baby-Kocher	772	Jamison Needle Holders	244
" Bainbridge	772	Jansen Bone Curettes	476
" Brunner	777	Jansen Bone Rongeurs	493
" Doyen	772, 773	Jansen Dressing Forceps	671
" Hartmann	772	Jansen Head Lights	4
" Kocher	774, 775	Jansen Hooklets	699
" Mayo-Robson	773	Jansen Raspatories	460
" Mikulicz	776	Jansen Retractor	381
" Moynihan	777	Jansen-Newhart Hooklets	699
" Parker-Kerr	776	Janson Needle Holders	246
" Scudder	777	Jarcho Uterine Tenaculum Forceps	878
Intra Oral Retractors	574-576	Jars	981
Intracardiac Needle Holders with T/C	263	Jars for Sterilizing	973, 977, 978
Intra-Operative Illuminators	11	Javid Carotid Clamp Forceps	822, 823
Iowa Puncturing Forceps	952	Jenning Mouth Gags	563-565
Iowa Uterine Tenaculum Forceps	884	Jewett Bone Plate Bender	544
Iris Scissors	44, 46, 48	Johns-Hopkins Bulldog Clamps	207, 208
Iris Scissors with T/C	87	Johns-Hopkins Dissecting and Ligature Forceps	184
Irrigators	981	Johns-Hopkins Vessel Clamps	854
Israel Retractor	322	Johnson Ophthalmic Knives	708, 709
Itard Ear Catheters	671	Johnson-Took Ophthalmic Knives	709
Iterson Tracheal Retractors	607	Joll (Friedman) Retractor	397
Ives-Fransler Rectal Specula	798	Joll (Friedman) Vaginal Retractors	942
Iwanson Caliper	968	Jolly Uterine Dilators	905
		Jones (Spencer-Wells) Haemostatic Forceps	172
<b>J</b>		Jones Towel Forceps	214
J. O. M. W. Type Uterine Curettes	915	Jonesco Ligature Needles	284
Jackson Biopsy Forceps for Rectum	805	Joseph Nasal Knives	625
Jackson Broncho-Esophagoscopy Forceps	604	Joseph Bone Files	473
Jackson Burrows Retractor	396	Joseph Raspatories	452
Jackson Laryngeal Polypus Forceps	582	Joseph Retractor	304
Jackson Nasal Scissors	618	Joseph Rhinoplastic Files	639, 640
Jackson Retractor	303, 308	Joseph Rhinoplastic Hooks	638
Jackson Tendon Seizing Forceps	432	Joseph Rhinoplastic Instruments	642
Jackson Tracheal Retractors	609	Joseph Rhinoplastic Measuring Device	640
Jackson Tracheal Tubes	610	Joseph Rhinoplastic Saws	640
Jackson Vaginal Speculum	931	Joseph Rhinoplastic Scissors	646
Jacobi Ligature Needles	744	Joseph Scissors	46
Jacobs Uterine Tenaculum Forceps	885	Joseph Septum and Periosteal Elevators	628
Jacobsen Paracentesis Needles	690	Joseph Septum Knives	625
Jacobson Bladder Retractor	415	Joseph-Masing Septum and Periosteal Elevators	630
Jacobson Bone Curettes	476	Judd-Allis Tissue and Organ Holding Forceps	768
Jacobson Micro Forceps	157	Judd-Masson Bladder Retractor	415
Jacobson Micro Needle Holders	274, 274	Juers Micro Wire Closure Forceps	678
Jacobson Micro Needle Holders with T/C	268	Jugs for Aqua Dest	981
Jacobson Micro Neuro Knives	749	Jugs Universal	981
Jacobson Micro Probes	750	Juillard Anaesthesia Mask	15
Jacobson Vascular Scissors	74	Julian Needle Holders	248
Jacobson-Adson Micro Forceps	156	Julian Needle Holders with T/C	261
Jacobson-Micro Haemostatic Forceps	163, 178	Jurasz Laryngeal Polypus Forceps	583
Jacobson-Potts Micro Aneurysm and Vessel Clips	753		
		<b>K</b>	
		K. N. Dass Obstetrical Forceps	962

	Page		Page
Kabierske Powder Blower	701	Kidney Pedicle Clamps (cont'd)	
Kader Retractor	372	"    Mayo	191
Kader Spatulas	372	"    Mayo-Guyon	191
Kader-Mathieu Needle Holders	255	"    Stille	190
Kahn Uterine Tenaculum Forceps	882	Kidney Stone Forceps	864, 865
Kahre-Williger Raspatories	450	"    Heiming	864
Kallmorgen Vaginal Retractors	940	"    Randall	864, 865
Kallmorgen Vaginal Speculum	940	"    Ray	865
Kalt Micro Needle Holders	269	Kidney Trays	987
Kalt Micro Needle Holders with T/C	268	Kielland Obstetrical Forceps	960
Kalt Ophthalmic Capsular Forceps	730	Kielland-Luikart Obstetrical Forceps	960
Kalt-Arruga Micro Needle Holders	269	Killian Antrum Cannulas	652
Kane Umbilical Cord Clamps	953	Killian Bone Cutters	488
Katsch Comedo Extractors	765	Killian Catheters	653
Katzenstein Rectal Cannulas	807	Killian Nasal Polypus and Septum Forceps	619
Katzin Ophthalmic Micro Scissors	739	Killian Nasal Speculum	615
Katzin-Barraquer Ophthalmic Micro Scissors	739	Killian Periosteal Elevators	631
Kaulich Plaster Lifter	115	Killian Raspatories	453
Kazanjan Bone Cutters	485	Killian Rectal Specula	795
Kelly Dissecting and Ligature Forceps	186	Killian Rhinoplastic Gouges	633
Kelly Dressing and Sponge Holding Forceps	217	Killian Septum and Periosteal Elevators	628
Kelly Haemostatic Forceps	164	Killian Septum Knives	627
Kelly Placenta and Ovum Forceps	948	Killian Septum Scissors	632
Kelly Rectal Specula	799	Killian-Claus Rhinoplastic Gouges	633
Kelly Retractor	348, 353	Kilner Needle Holders	242
Kelly Scissors	48	Kilner Needle Holders with T/C	259, 260
Kelly Scissors with T/C	87	Kilner Neuro Hooklets	765
Kelly Suture Scissors	294	Kilner Retractor	304, 305
Kelly Uterine Dressing Forceps	887	Kilner Rhinoplastic Retractors	638
Kelly-Gray Biopsy Curettes	908	Kilner Scissors	47, 49
Kelsey-Fry Awls	586	Kilner-Dott Mouth Gags	565
Keratomes for Ophthalmology	707	Kilner-Doughty Mouth Gags	568
"    Barens	707	Kilner-Kelly Haemostatic Forceps	165
"    Castroviejo	707	Kilner-Russel Mouth Gags	565
"    Jaeger	707	Kirby Cataract Operating Instruments	716
"    Jaeger-Grieshaber	707	Kirby-Artur Ophthalmic Fixation Forceps	728
"    Papst	707	Kirk Mallet	421
"    Rowland	707	Kirmission Raspatories	451
"    Weeker	707	Kirsch Retractor	342
"    Weiner	707	Kirschner (Semm) Abdominal Retractor	412
Kern Bone Holding Forceps	508	Kirschner Abdominal Retractor	410
Kern-Lane Bone Holding Forceps	508	Kirschner Extension Bows	545, 546
Kern-Mini Bone Holding Forceps	508	Kirschner Ligature Conductors	289, 290
Kerpel Bone Curettes	477	Kirschner Needle Holders	250
Kerrison Punches	654-656	Kirstein Nasal Scissors	618
Kersting Atrauma Intestinal Clamp Forceps	794	Kistner Septum and Periosteal Elevators	628
Kersting Atrauma Sigmoid Anastomosis Forceps	791	Knapp Retractor	313
Kevorkian Biopsy Curettes	907	Kleinert-Kutz Bone Rongeurs	495, 498
Kevorkian Uterine Biopsy Forceps	893, 898	Kleinert-Kutz Retractor	306
Kevorkian-Pacific Uterine Biopsy Forceps	897, 898	Kleinert-Kutz Tendon Seizing Forceps	431
Key Elevators	461	Kleinschmid Intestinal and Stomach Clamp Forceps	783
Key Raspatories	458	Klima-Rosegger Hypodermic and Biopsy Needles	240
Keys Dermal Punches	766	Klinikum Berlin Haemostatic Forceps	172
Kidney Elevating Forceps	867	Klinkenbergh-Loth Vascular Scissors	73
"    Collin	867	Knapp Double Instruments	724
"    Dartigues	867	Knapp Ophthalmic Chisels	710
"    Kocher	867	Knapp Ophthalmic Expression Forceps	736
Kidney Pedical Clamp Forceps	868	Knapp Ophthalmic Knives	708
"    Werthiem Atrauma	868	Knapp Ophthalmic Retractors	713
"    Werthiem	868	Knapp Ophthalmic Scoops	715
"    Werthiem-Cullen	868	Knapp Retractor	309, 310
Kidney Pedicle Clamps	190, 191	Knapp Wire Scissors	51
"    Guyon	190, 191	Knapp-Clark Eye Speculum	702
"    Guyon Atrauma	201	Knight Nasal Polypus and Septum Forceps	619
"    Herrick	190	Knight Nasal Scissors	618



INVENT GERMANY

# INHALTSVERZEICHNIS INDEX INDEX

	Page		Page
Knights Tonsil and Nasal Scissors	79	Knives Ophthalmic (cont'd)	
Knighton Retractor	394, 399	" Bowman	708
Knives	32-43, 123	" Burch	709
Knives Abscess	34	" Castroviejo	706, 707
Knives Amputation	41, 42	" Curdy	709
Knives Anatomy	36-40	" Daily	709
Knives Cone	35	" Dean	709
Knives Cone Ayre	902	" Desmarres	709
Knives Dura	32, 33	" Deutschmann	706
Knives Ear	688, 689	" Elschmig	709
" Bruehl	689	" Gill	709
" Buck	688	" Girard Swan	710
" Lempert	688	" Graefe	706, 708, 709
" Muck	689	" Graefe-Arruga	706
" Plester	688	" Guthrie	709
" Politzer	689	" Guyton-Lundsgaard	709
" Rosen	688	" Haab	709
" Schuknecht	688	" Jaeger	707
" Tabb	688	" Jaeger-Grieshaber	707
" Wullstein	688	" Johnson	708, 709
Knives Fistula	33	" Johnson-Took	709
Knives Lancets	35	" Knapp	708
Knives Meniscectomy	426, 427	" Kuhnt	708
" Bircher	426	" Lundsgaard	709
" Canad. Model	426	" McReynolds	709
" Downing	427	" Mod. Hamburg	708
" Lowe-Beck	427	" Mod. Tübingen	708
" Nett	427	" Papst	707
" Salenius	427	" Paton	709
" Smillie	426	" Paufigue	709
" Stryker-Scholl	426	" Rowland	707
" Swiss Model	426	" Sato	708
" Wagner	427	" Scheie	709
Knives Nail	123	" Schmith-Green	706
Knives Nasal	625, 626	" Schnaudigl	708
" Ballenger	626	" Searcy	709
" Bruenings	626	" Sichel	708
" Converse	625	" Took	709
" Cottle	625	" Troutman	710
" Fomon	625	" Walker-Lee	709
" Freer	626	" Weber	708
" Halle	626	" Weeker	707, 709
" Heymann	625	" Weiner	707
" Joseph	625	" Wheeler	706
" Krieg	625	" Ziegler	708
Knives Neuro	749, 762	Knives Plaster	114
" Bucy	762	" Esmarch	114
" Fisch	749	" Hopkins	114
" Frazier	762	" Korte	114
" Halle	762	" Reiner	114
" Jacobson	749	Knives Post Mortem	36-40
" Koos	749	Knives Scarifying	35
" Kraus	749	Knives Septum	628-627
" Olivecrona	762	" Ballenger	627
" Toennis	762	" Flataue	626
" Yasargil	749	" Freer	627
Knives Ophthalmic	705-710	" Freer-Ingals	627
" Anderson-Critchett	709	" Joseph	625
" Axenfeld	709	" Killian	627
" Barens	707	" Maltz	626
" Barkan	709	Knives Skin Grafting	43
" Barraquer	706, 709	Knives Tonsil	587-589
" Beer	706	" Abraham	587, 588
" Berens	706	" Brophy	588
" Blascovics	709	" Bruenings	587





# INHALTSVERZEICHNIS INDEX INDEX

	Page		Page
Knives Tonsil (cont'd)		Krayenbuhl Nerve Hooks	749
" Canfield	587	Krayenbuhl Retractor	307
" Carpenter	589	Kremer Ophthalmic Radial Keratomy Forceps	737
" Colver	588	Kressner Rhinoplastic Rongeurs	642
" Day	588	Krieg Nasal Knives	625
" Dean	589	Krishaber Tracheal Tubes	611
" Douglas	588	Krishaber-Luer Tracheal Tubes	611
" Fischer	588	Kristeller (Wiener Model) Vaginal Retractors	939
" Freer	588	Kristeller (Wiener Model) Vaginal Speculum	939
" Harris	589	Kristeller Vaginal Retractors	935-938
" Lothrop	587	Kristeller Vaginal Speculum	932, 935-938
" Lynch	587	Kronecker Ligature Needles	280
" Milette	589	Kronfeld (Panas) Ophthalmic Suture Forceps	732
" Robb	587	Kronfeld Ophthalmic Suture Forceps	732
" Robertson	588	Kronlein Haemostatic Forceps	171
" Tyding	587	Kuemmel Retractor	371
" Whitehead	589	Kuemmel Spatulas	371
Knives Trigeminal	34	Kuffler Hysterectomy Forceps	194
Knorr Plaster Spreaders	113	Kuhne Cilia Forceps	149
Knowles Bandage Scissors	105	Kuhnt Ophthalmic Gouges	710
Knutson Urethrography Instruments	877	Kuhnt Ophthalmic Knives	708
Kocher (Ochsner) Haemostatic Forceps	174, 175	Kuhnt Ophthalmic Skeleton Forceps	736
Kocher Atrauma Intestinal and Stomach Clamp Forceps	786	Kuntscher Bone Wire Guides	546
Kocher Bladder Retractor	418	Kustner Uterine Tenaculum Forceps	884
Kocher Haemostatic Forceps	171-173, 176	Kuttner Retractor	380
Kocher Intestinal Clamp Forceps	774, 775	Kyle Ligature Carriers	590
Kocher Kidney Elevating Forceps	867		
Kocher Ligature Conductors	289	<b>L</b>	
Kocher Ligature Needles	280	La Force Adenoid Curettes	650
Kocher Retractor	301, 314, 318-320, 330, 334, 344, 374, 393	La Force Ophthalmic Needles	710
Kocher Spatulas	374	La Force Suture Instruments	291
Kocher-Langenbeck Retractor	331	La Force-Stevenson Adenoid Curettes	650
Kocher-Nippon Haemostatic Forceps	177	Laborde Tracheal Dilators	607
Kocher-Wagner Retractor	345	Lachrymal Dilators	720, 721
Koenig Elevators	462	" Castroviejo	720
Koenig Ligature Conductors	288	" Galezowsky	720
Koenig Needle Holders	251	" Muldoon	720
Koenig Raspatories	451	" Raverdino	720
Koenig Retractor	300	" Simpson	720
Koenig Tissue Forceps	134	" Wilder	720
Koenig Tuning Forks	686	" Ziegler	721
Koerte Retractor	371	Lachrymal Elevators Lueneburg	723
Koerte Spatulas	371	Lachrymal Marker Connin-Amsler	723
Kofler Nasal Polypus Forceps	622	Lachrymal Probes	719, 720
Kofler Punches	658	" Bowmann	719, 720
Kogan Endospecula	943	" Bowmann (Williams)	720
Konrich Sterilizing Boxes	976	" Galezowsky	720
Koos Micro Neuro Knives	749	" Rolf	719
Korte Plaster Knives	114	" Ziegler	719
Korte Retractor	317	Lachrymal Sac Gouges West	723
Korte-Wagner Retractor	319	LaGrange Canaliculus Punches	722
Kraemer Rongeurs	666	LaGrange Ophthalmic Enucleation Scissors	743
Kramer Bone Curettes	482	Lahey (Sweet) Bronchus and Gall Duct Clamps	188
Kramer Bone Gouges	437	Lahey Bronchus and Gall Duct Clamps	188
Kramer Raspatories	455	Lahey Clinic Retractor	305
Kramer Retractor	342	Lahey Dura Hooks	759
Kranz Placenta and Ovum Forceps	950	Lahey Retractor	326, 333
Kraus Micro Neuro Knives	749	Lahey Uterine Tenaculum Forceps	879
Krause Cutting Forceps Tips	600	Lambert Chalazion Forceps	737
Krause Ear Polypus Snares	671	Lambert-Kay Atrauma Cardiovascular Forceps	825
Krause Nasal Snares	618	Lambert-Kay Modif. Atrauma Cardiovascular Forceps	825
Krause Trocars	230	Lambert-Lowmann Bone Holding Clamp Forceps	517
Krause Uterine Biopsy Forceps	896	Lambotte Bone Holding Forceps	511
Krause-Voss Ear Polypus Snares	671	Lambotte Bone Levers	466
Krause-Voss Nasal Snares	618		

	Page		Page
Lambotte Bone Osteotomes	439, 443	Laryngeal Polypus Forceps (cont'd)	
Lambotte Raspatories	449	"    Waldenstrom	582
Laminectomy Retractors	419	Laryngeal Scissors	605, 606
Lampert Retractor	318	Laryngoscopes	557-561
Lancaster Eye Speculum	702	Laryngoscope Fogger	560
Lancaster Retractor	380	Laryngoscope Handles	556, 557
Lancet Knives	35	Laryngoscope McIntosh	558
Lancet-Duo Lancets Knives	35	Laryngoscope Miller	561
Landau Trocars	229	Laryngoscope Negus	559
Landau Vaginal Speculum	934	Laryngoscope Blades	558-561
Landolt Raspatories	456	Lawrence Dissecting and Ligature Forceps	186
Landolt Rongeurs	665	Le Mee Tongue Depressors	571
Landolt Suction Tubes	239	Lead Hands	518
Landon Vaginal Retractors	940	Lebsche Instrument for Cranial Opening	755
Lane Bone Holding Forceps	509	Lebsche Ligature Conductors	290
Lane Bone Levers	465	Lebsche Rib Shears	521, 522
Lane Bone Plate Bender	544	Lebsche Sternum Instruments	523
Lane Bone Screw Holding Forceps	544	Lees Atrauma Cardiovascular Forceps	826
Lane Intestinal and Stomach Clamp Forceps	781	Legueu Bladder Retractor	417, 418
Lane Retractor	376	Legueu Retractor	344
Lane Screw Drivers	542, 543	Leineweber Tonsil Seizing Forceps	595
Lane Tissue and Organ Holding Forceps	769	Leksell Bone Rongeurs	500
Lane Tissue Forceps	137	Leland-Jones Atrauma Cardiovascular Forceps	827
Lane Towel Forceps	213	Lemmon Rib Spreaders and Contractors	535
Lane-Trethowan Bone Levers	465	Lempert Bone Curettes	480
Lang Ophthalmic Dissectors	718	Lempert Bone Rongeurs	494, 496
Lange Bandage Scissors	104	Lempert Ear Curettes	700
Lange Bone Levers	466	Lempert Ear Elevators	700
Lange Grasping Forceps Tips	600	Lempert Ear Excavators	700
Lange Laryngeal Polypus Forceps	583	Lempert Ear Knives	688
Lange Retractor	304	Lempert Ear Raspatories	700
Lange Septum and Periosteal Elevators	630	Lempert Micro Malleus Nippers	679
Lange Suture Forceps	292	Lempert Paracentesis Needles	691
Lange-Baby Bone Levers	466	Lempert Raspatories	454
Lange-Hohmann Bone Levers	468, 469	Lens Expressors Ophthalmic	713, 715
Lange-Hohmann Modif. Bone Levers	469	"    Amenabar	715
Langenbeck Amputation Knives	42	"    Barens	713
Langenbeck Amputation Saws	119	"    Wilmer-Bagley	713
Langenbeck Anatomy and Post Mortem Knives	37	Leriche Haemostatic Forceps	165
Langenbeck Bone Holding Forceps	507	Leriche Retractor	372
Langenbeck Bone Levers	463, 464	Leriche Spatulas	372
Langenbeck Ear Curettes	696	Lester Ophthalmic Tissue Forceps	732
Langenbeck Finger Protectors	573	Lever Obstetric	955
Langenbeck Ligature Needles	283	Levers Bone	463-472
Langenbeck Mannerfelt Modif. Retractor	301	"    Aufranc	472
Langenbeck Needle Holders	251	"    Bennet	469
Langenbeck Needle Holders with T/C	268	"    Blount	465, 466
Langenbeck Raspatories	451	"    Bristow	471
Langenbeck Retractor	327-329, 332	"    Buck-Gramcko	464, 465
Langenbeck-Green Retractor	326	"    Bunnell	464
Langenbeck-Mannerfelt Modif. Retractor	326	"    Hohmann	467, 468
Langenbeck-Ryder Needle Holders with T/C	268	"    Hohmann-Aldinger	471
Lange-Wilde Ear Polypus Snares	671	"    Lambotte	466
Lange-Wilde Nasal Snares	618	"    Lane	465
Larkin Elevators	694	"    Lane-Trethowan	465
Larkin Footplate Hand Instruments	694	"    Lange	466
Laryngeal Forceps	605, 606	"    Lange-Baby	466
Laryngeal Mirror Handles	580, 581	"    Lange-Hohmann	468, 469
Laryngeal Mirrors	580, 581	"    Lange-Hohmann Modif.	469
Laryngeal Polypus Forceps	582, 583	"    Langenbeck	463, 464
"    Fraenkel	582, 583	"    Meyerding	472
"    Jackson	582	"    Mini-Hohmann	465
"    Jurasz	583	"    Murphy-Lane	471
"    Lange	583	"    Quervain	464
"    Tobold	582	"    Schumacher	470

	Page		Page
Levers Bone (cont'd)		" Craft	286
" Schumacher Mod. Wagner	471	" Da la Roza	744
" Tager	470	" Deschamps	281, 282
" Taylor	466	" Dupuy-Weiss	284
" Wagner	468, 472	" Durham	285
Levinson Ophthalmic Needles	710	" Emmet	284
Levy Haemorrhoidal Ligators	802	" Falk	285
Lewin Bone Holding Forceps	503	" Hessberg	744
Lewis Bone Files	474	" Jacobi	744
Lewis Gauze Packers	591	" Jonesco	284
Lewis Ophthalmic Scoops	715	" Kocher	280
Lewis Rhinoplastic Files	639	" Kronecker	280
Lewkowitz Lithotomy Forceps	872	" Langenbeck	283
Lewkowitz Placenta and Ovum Forceps	949	" Nager	285
Lexer Bone Chisels	447	" Pauchet	284
Lexer Bone Gouges	444, 447	" Payer	283
Lexer Bone Osteotomes	444, 447	" Schmeiden Dick	279
Lexer Scissors with T/C	90	" Schmieden	279
Lexer Tissue Forceps	137	" Syme	286
Lexer-Baby (Knapp) Dissecting Scissors	67	" Trelat	285
Lexer-Baby (Knapp) Scissors with T/C	89	" Woodruff	744
Lexer-Fino Dissecting Scissors	67	" Yankauer	284
Lichtenberg Needle Holders	253	" Young	279
Lichtenberg Needle Holders with T/C	266, 267	" Young-Hryntschank	279
Lichtwitz Trocars	230, 231	Ligature Scissors	53-55
Lid Everters	704	Lillianthal Rib Spreaders	533
" Berens	704	Lincoln Vascular Scissors	76
" Muldoon	704	Lindemann Amputation Saws	119
" Pess	704	Lindner Double Instruments	724
" Schepens	704	Lip and Cheek Retractors	572, 573
" Siniscal-Smith	704	Lister Bandage Scissors	105-107
Lid Expressor Amenabar	704	Lister Bandage Scissors with T/C	103
Lid Retractors	704	Lister Dressing and Sponge Holding Forceps	215
" Conway	704	Lister Excentric Bandage Scissors	106
" Desmarres	704	Lister-Burch Eye Speculum	702
" Groenholm	704	Liston Amputation Knives	41
Ligators Haemorrhoidal	802	Liston Bone Cutters	486, 487, 489
" Levy	802	Liston-Key-Horsley Bone Cutters	490
" McGivney Modif.	803	Liston-Stille Bone Cutters	489
" Rudd	803	Littauer Cilia Forceps	149
Ligature Carriers	590	Littauer Ear Polypus Forceps	672
" Boettcher	590	Littauer Ligature Scissors	54
" Cover	590	Littauer Nasal Polypus and Septum Forceps	619
" Kyle	590	Littauer-Liston Bone Cutters	485
" Roeder	590	Little Retractor	301
Ligature Conductors	287-290	Littler Dissecting Scissors	71
" Braatz Krause	290	Littler Rhinoplastic Scissors	645
" Brunner	287, 290	Littlewood Uterine Tenaculum Forceps	885
" Ferrozol	289, 290	Lloyd-Davis (Goligher's) Rectal Scissors	801
" Hofmeister	289	Lloyd-Davis (St. Marks) Pelvis Retractors	800
" Kirschner	289, 290	Lloyd-Davis Intestinal and Stomach Clamp Forceps	784
" Kocher	289	Lloyed Instrument for Hip Nailing	544
" Koenig	288	Lockhart-Mummery Rectal Probes	803
" Lebsche	290	Locklin Gum Scissors	86
" Payr	289	Locklin Scissors	48
" Schmieden	288	Locklin Scissors with T/C	88
" Schmieden-Payr	288	Locklin Suture Scissors	294
" Stille	288	Lockwood Tissue and Organ Holding Forceps	768
Ligature Guides Micro	750	Lockwood-Allis Tissue and Organ Holding Forceps	768
Ligature Guides Micro Yasargil	750	Loebker Tongue Holding Forceps	579
Ligature Needles	279-286, 744	Logan Retractor	379
" Brunner	280, 285	London-Hospital Sterilizing Forceps	965
" Clas-Eicken	285	Long Hysterectomy Forceps	194
" Claus	285	Loops Ear	697, 698
" Cooper	280	" Billeau	698



# INHALTSVERZEICHNIS INDEX INDEX

	Page		Page
Loops Ear (cont'd)		Luniatschek Gauze Packers	591
" Billeau-Micro	698	Lurz Ureter Calculus Forceps	866
" Gardner-Brown	697	Lynch Tonsil Knives	587
" Gross	697		
" Roser	697	<b>M</b>	
Lordan Chalazion Forceps	738	M. G. H. Needle Holders	244
Lorenz Bandage Scissors	107	MacDonald Raspatories	453
Lorna Towel Forceps	212	Machatt Retractor	310
Lothrop Tonsil Knives	587	Mackay Sinus Forceps	606
Lothrop Tonsil Retractors	591	Mackay Sinus Forceps	606
Loute Bone Wire Tighteners	548	Mackensen Trabecular Probes	719
Love (Morse) Retractor	302	Mackenzie Tonsillectomes	598
Love Nerve Root Retractors	764	Magil Catheter Forceps	569
Love Retractor	302	Maier Dressing and Sponge Holding Forceps	219
Love Tonsil Retractors	591	Maier Dressing and Washing Forceps	223
Love-Gruenwald Rongeurs	663	Maier Scarifying Knives	35
Lovelace Tissue and Organ Holding Forceps	768	Maingot Hysterectomy Forceps	194
Lowe-Beck Meniscectomy Knives	427	Mallets	420-425
Lower Bronchus and Gall Duct Clamps	188	" Bergmann	421
Lower Trocars	232	" Bergmann (Hibbs)	421
Lowmann Bone Holding Clamp Forceps	516	" Collin	423
Lowmann-Gerster Bone Holding Clamp Forceps	517	" Cottle	421
Lowmann-Hoglund Bone Holding Clamp Forceps	517	" Doyen	420
Loez-Reinke Suction Tubes	239	" Gerzog	421
Lubet-Barboni Nasal Polypus and Septum Forceps	619	" Hajek	420
Luc Nasal Polypus and Cutting Forceps	621	" Heath	423
Lucae (Royce) Paracentesis Needles	691	" Kirk	421
Lucae Dressing Forceps	142, 671	" Lucae	420
Lucae Hooklets	699	" Mead	420
Lucae Mallet	420	" Ombroedanne	421
Lucae Paracentesis Needles	690	" Partsch	423
Lucae Retractor	306	" Steinbach	423
Lucae Tissue Forceps	142	" Wagner	424
Lucae Tuning Forks	684, 686	" Williger	420
Lucas Bone Chisels	438	Maltz Rhinoplastic Files	639
Lucas Bone Curettes	476	Maltz Septum Knives	626
Lucas Bone Gouges	438	Mannerfelt Modif. Bone Osteotomes	435
Lucas Curettes	765	Mannerfelt Bone Gouges	435
" Fox	765	Mannerfelt Modif. Raspatories	458
" Moncorps	765	Mannerfelt Modif. Retractor	300, 301, 308-310
" Piffard	765	Marcuse Tubing Clamps	210
" Vidal	765	Markham-Meyerding Retractor	394
" Wolff	765	Markwalder Bone Cutters	486
Lueneburg Lachrymal Elevators	723	Markwalder Bone Rongeurs	502
Luer Bone Rongeurs	492	Marquardt Bone Rongeurs	497
Luer Haemorrhoidal Forceps	800	Marquet Foreign Body Levers	672
Luer Retractor	302, 308, 375	Marschik Gauze Forceps	591
Luer Spud	710	Marschik-Krone Tonsil Seizing Forceps	594
Luer Tracheal Retractors	609	Martel Haemostatic Forceps	176
Luer Tracheal Tubes	611	Martel Instrument for Cranial Opening	755
Luer-Freidmann Bone Rongeurs	491	Martini Bone Curettes	476
Luer-Koerte Gall Stone Scoops	861	Masing Needle Holders with T/C	258
Luer-Lock Ear Syringes	701	Masing Retractor	298
Luethy-Beck Needle Holders	256	Masing Rhinoplastic Files	640
Luethy-Beck Needle Holders with T/C	267	Masing Rhinoplastic Forceps	644
Lulkart Obstetrical Forceps	960	Masing Rhinoplastic Retractors	637
Lukens Retractor	308	Masing Septum and Periosteal Elevators	629
Lukens Tracheal Retractors	609	Mask, Anaesthesia	15
Lundsgaard Ophthalmic Knives	709	Mask, Face Protecting	4
Lung Grasping Forceps	537	Mason Mouth Gags	562
" Allis	537	Mason Plaster Breakers	112
" Babcock	537	Mason-Ackland Mouth Gags	562
" Duval	537	Masson Needle Holders	246
" Williams	537	Masson Needle Holders with T/C	264
Luniatschek Cotton Dispenser	989		

	Page		Page
Masson-Luethy Needle Holders	246	McIndoe Rhinoplastic Chisel	636
Mathie-Kersten Needle Holders	253	McIndoe Rhinoplastic Scissors	645
Mathieu Needle Holders	252, 254	McIndoe Vascular Scissors	73
Mathieu Raspatories	457	McIntosh Laryngoscopes	558
Mathieu Rectal Specula	795	McIvor Mouth Gags	567
Mathieu Retractor	376	McKenty Raspatories	449
Mathieu Tongue Holding Forceps	579	McKenty Septum and Periosteal Elevators	628, 629
Mathieu Vaginal Speculum	932	McKenzie Clip Applying Forceps	754
Mathieu-Kocher Needle Holders	252, 254	Mc-Kenzie Cranial Opener	754
Mathieu-Kocher Needle Holders with T/C	266	McKenzie Modif. Clip Applying Forceps	754
Mathieu-Slim Needle Holders with T/C	266	McPherson Ophthalmic Capsular Forceps	731
Mathieu-Stille Needle Holders	254	McPherson Ophthalmic Strabismus Forceps	734
Mathieu-Sverige Needle Holders	253	McPherson-Vannas Ophthalmic Micro Scissors	741
Matson Raspatories	458	McPherson-Westcott Ophthalmic Tenotomy Scissors	741
Matzenauer Vaginal Speculum	934	McQuigg-Mixer Bronchus and Gall Duct Clamps	188
Maumenee-Colibri Ophthalmic Fixation Forceps	728	McReynolds Double Instruments	724
Maunoir Scissors	47	McReynolds Ophthalmic Knives	709
Maxillary Mobilizers	584	McWorther-Lothrop Tonsil Seizing Forceps	595
Mayfield Bone Rongeurs	498	Mead Bone Rongeurs	494, 495
Mayo Gall Stone Scoops	860, 862	Mead Mallet	420
Mayo Kidney Pedicle Clamps	191	Mead Raspatories	452
Mayo Needle Holders	256	Measuring Instruments	10, 640, 841, 968
Mayo Operating Scissors	62	" Bertillon	10
Mayo Probes	857	" Castroviejo	10
Mayo Safety Pins	969	" Device	841
Mayo Scissors with T/C	91	" Device Rhinoplastic Joseph	640
Mayo Skin Grafting Knives	43	" Moeltgen	10
Mayo Tongue Depressors	570	" Thole	10
Mayo Uterine Sounds	900	Medicine Cups	983
Mayo-Adams Retractor	386, 395	Medicine Spoons	983
Mayo-Blake Gall Stone Forceps	860	Medina Uterine Biopsy Forceps	894
Mayo-Collin Retractor	377	Meeker Haemostatic Forceps	178
Mayo-Guyon Kidney Pedicle Clamps	191	Mehmke Micro Crura Nippers	679
Mayo-Harrington Operating Scissors	62	Meillinger Retractor	380
Mayo-Harrington Scissor with T/C	93	Mellinger Eye Speculum	703
Mayo-Hegar (Heaney) Needle Holders with T/C	261	Mellinger-Axenfeld Eye Speculum	703
Mayo-Hegar Needle Holders	241	Mellinger-Beard Eye Speculum	703
Mayo-Hegar Needle Holders with T/C	261	Meniscectomy Forceps	428
Mayo-Hegar Seeley Needle Holders	243	" Bircher	428
Mayo-Hegar-Seeley Needle Holders with T/C	261	" Bircher-Ganske	428
Mayo-Lexer Scissors with T/C	90	" Herz	428
Mayo-Noble Gynecological Scissors	84	" Jager	428
Mayo-Robson Atrauma Intestinal and Stomach Clamp Forceps	787	" Weller	428
Mayo-Robson Intestinal Clamp Forceps	773	Meniscectomy Knives	426, 427
Mayo-Russian Dressing Forceps	141	" Bircher	426
Mayo-Stille Operating Scissors	61	" Canad. Model	426
Mayo-Stille Scissors with T/C	92	" Downing	427
Mc Clintock Placenta and Ovum Forceps	948	" Lowe-Beck	427
Mc Givney Haemorrhoidal Forceps	800	" Nett	427
Mc Lean Obstetrical Forceps	960	" Salenius	427
Mc Lean-Luikart Obstetrical Forceps	961	" Smillie	426
Mc Lean-Rucker-Luikart Obstetrical Forceps	961	" Stryker-Scholl	426
McClure Ophthalmic Micro Scissors	740	" Swiss Model	426
McCullough Ophthalmic Strabismus Forceps	733	" Wagner	427
McDonald Elevators	463	Methot Cotton Dispenser	989
McEwen Bone Chisels	440	Metzenbaum Dissecting Scissors	71
McGannan Ophthalmic Retractors	713	Metzenbaum Needle Holders	248
McGee Ear Hooks	693	Metzenbaum Rhinoplastic Chisel	633
McGee Micro Wire Closure Forceps	678	Metzenbaum Scissors with T/C	94, 96
McGivney Modif. Haemorrhoidal Ligators	803	Metzenbaum-Fino Dissecting Scissors	65, 66
McGuire Ophthalmic Enucleation Scissors	743	Metzenbaum-Fino Scissors with T/C	95-99
McHough Ear Elevators	700	Metzenbaum-Lahey Scissors with T/C	96
McIndoe Dressing Forceps	132	Metzenbaum-Lahey Scissors with T/C	96
McIndoe Bone Cutters	488	Metzenbaum-Mathieu Needle Holders	251
McIndoe Dressing Forceps with T/C	159	Metzenbaum-Mathieu Needle Holders with T/C	266
		Metzenbaum-Nelson Dissecting Scissors	68-70

	Page		Page
Metzenbaum-Thorek Scissors with T/C	97	Micro Ophthalmic Micro Scissors	740
Meyer Bone Holding Forceps	504	Micro Probes	750
Meyer Ophthalmic Gouges	710	"    Jacobson	750
Meyerding Blades for Laminectomy Retractors	419	"    Yasargil	750
Meyerding Bone Levers	472	Micro Raspatories Yasargil	750
Meyerding Retractor	313, 339, 394	Micro Scoops Yasargil	750
Meyer-Schwickerath Ophthalmic Cystotomes	713	Micro Stevens Scissors	48
Meyhoefer Chalazion Curettes	717	Micro Wire Closure Forceps	678, 679
Mezenbaum-S Scissors with T/C	98	"    Greven	678
Michel Laryngeal Mirrors	581	"    Juers	678
Michel Modif. Suture Forceps	293	"    McGee	678
Michel Suture and Pocket Instrument Set	295	"    Schuknecht	678
Michel Suture Forceps	292, 293	Micro-Adson Dressing Forceps	139
Micro Crura Nippers	679	Micro-Adson Tissue Forceps	139
Micro Crura Nippers Mehmke	679	Micro-Adson-Biemer Tissue Forceps	140
Micro Dissectors Hardy	751	Micro-Coron Bulldog Clamps	208
Micro Ear Forceps	674-676	Micro-Halstead Haemostatic Forceps	162
"    Mini McGee Alligator	674	Micro-Hartmann Haemostatic Forceps	161
"    Wullstein-Blakesley	675	Micro-Slim Needle Holders with T/C	263
Micro Ear Scissors	676, 677	Middeldorpf	340
"    Bellucci	676, 677	Middleton Adenoid Curettes	649
"    Shea-Bellucci	677	Middleton-Jansen Nasal Cutting Forceps	623
"    Wullstein	677	Middleton-Struycken Nasal Cutting Forceps	623
Micro Enucleators Hardy	751	Mikulicz Peritoneal Clamp Forceps	204-206
Micro Forceps	153-157	Mikulicz Intestinal Clamp Forceps	776
Micro Instruments Sterilizing Cases	972	Mikulicz Retractor	320, 353, 354, 373
Micro Introduction Instruments	679	Mikulicz Spatulas	373
"    Davol	679	Milan Uterine Curettes	913
"    Fuller	679	Milette Tonsil Knives	589
"    House-Dieter	679	Miller Bone Files	473
Micro Ligature Guides Yasargil	750	Miller Laryngoscopes	561
Micro Malleus Nippers Lempert	679	Miller Rectal Scissors	801
Micro Malleus Nippers Wullstein	679	Milian-Bacon Bladder Retractor	417
Micro Needle Holders	269-275	Milligan Dura Dissectors	758
"    Arruga	269, 272	Milligan Retractor	382
"    Barens	269	Millin Bladder Retractor	416, 417
"    Barraquer	269, 270	Millin Prostatectomy Atrauma Forceps	871
"    Barraquer-Troutman	270	Millin Prostatectomy Forceps	871
"    Brock	272	Millison Retractor	382
"    Castroviejo with T/C	268	Mills Vascular Scissors	75
"    Castroviejo-Kalt	269	Milne-Murray Obstetrical Forceps	963
"    Castroviejo	271, 272, 274	Mini McGee Alligator Micro Ear Forceps	674
"    Castroviejo-Barraquer	274	Mini Micro Aneurysm and Vessel Clips	753
"    Gomel	274	Mini Thoracotomy Rib Spreaders	532
"    Jacobson	274, 274	Mini-Freidmann Bone Rongeurs	491
"    Jacobson with T/C	268	Mini-Gemini Dissecting and Ligature Forceps	181
"    Kalt	269	Mini-Hohmann Bone Levers	465
"    Kalt with T/C	268	Mini-Lambotte Bone Osteotomes	442, 443
"    Kalt-Arruga	269	Mini-Langenbeck Retractor	326
"    Muller	272	Mini-Lexer Bone Gouges	443
"    Noyes	270	Mini-Lexer Bone Osteotomes	443
"    Paton	271	Mini-Roux Retractor	376
"    Potts-Smith	269	Mini-Ryder Needle Holders with T/C	262
"    Reill	272	Mini-Townsend Uterine Biopsy Forceps	898
"    Rohrschneider	271	Mirror Handles	580, 581
"    Stevens	269	Miskimon Retractor	388
"    Yasargil	275	Mixter-O'Shaughnessy Bronchus and Gall Duct Clamps	187
Micro Neuro Forceps	751, 752	Mixter Bronchus and Gall Duct Clamps	187, 189
Micro Neuro Knives	749	Mixter Dissecting and Ligature Forceps	183
Micro Neuro Knives Fisch	749	Mixter Gall Stone Forceps	858
"    Jacobson	749	Mixter Operating Scissors	64
"    Koos	749	Mixter Probes	857
"    Kraus	749	Mixter-Baby Dissecting and Ligature Forceps	184
"    Yasargil	749	Moberg Bone Osteotomes	437
Micro Neuro Scissors Yasargil	747, 748	Moberg Rhinoplastic Chisel	636

	Page		Page
Mobile Percussion Hammers	17	Moynihan Probes	857
Mod. Berlin Biopsy Curettes	908	Moynihan Stomach Clamp Forceps	779
Mod. Bonn Ophthalmic Hooks	712	Moynihan Towel Forceps	213
Mod. Bonn Ophthalmic Iris Forceps	726, 727	Muck Ear Knives	689
Mod. Hamburg Ophthalmic Knives	708	Muck Tonsil Seizing Forceps	595
Mod. Heidelberg Swab Holders	744	Mueller Retractor	379
Mod. Klinikum Berlin Haemostatic Forceps	172	Muhling Bone Cutters	488
Mod. Klinikum-Berlin Tubing Clamps	210	Muhling Raspatories	457
Mod. Muenchen Biopsy Curettes	908	Muhling Septum Scissors	632
Mod. Tübingen Ophthalmic Hooks	712	Muldoon Lachrymal Dilators	720
Mod. Tübingen Ophthalmic Knives	708	Muldoon Lid Everters	704
Mod. Tübingen Ophthalmic Strabismus Forceps	733	Muller Eye Speculum	703
Mod. USA Bone Curettes	479	Muller Micro Needle Holders	272
Mod. USA Umbilical Scissors	86	Muller Retractor	305
Mod. Wein Nasal Speculum	613	Mulux Tongue Depressors	572
Model Tübingen Retractor	336	Murdock Eye Speculum	703
Moeltgen Measuring Instrument	10	Murless Obstetrical Forceps	960
Mohr Tubing Clamps	969	Murphy Bone Gouges	438
Moldenhauer Foreign Body Instruments	698	Murphy Bone Osteotomes	438
Moldestad Retractor	304	Murphy Retractor	321
Moleskin Plaster Shears	111	Murphy-Lane Bone Levers	471
Molt Bone Files	473	Museux Tonsil Seizing Forceps	595
Molt Mouth Gags	563	Museux Uterine Tenaculum Forceps	879, 883, 884
Molt Raspatories	452	Museux-Palmer Uterine Tenaculum Forceps	884
Moncorps Lucas Curettes	765	Myles Cannula	653
Moore Gall Stone Scoops	862	Myles Nasal Cutting Forceps	624
Moore Hand Drills	539	Myomatome Knives	35
Moorfield Double Instruments	724	Myomatomes	899
Moorfield Ophthalmic Suture Forceps	732		
Moritz-Schmidt Tongue Depressors	572	<b>N</b>	
Morris Atrauma Sigmoid Anastomosis Forceps	793	Naegele Obstetrical Forceps	958
Morris Retractor	352	Naegele Perforators	950
Morris-De Bakey Atrauma Cardiovascular Forceps	820	Nager Ligature Needles	285
Morrison Davies Retractor	355	Nager Tonsil Needles	592
Morse Rib Spreaders	524	Nager Tonsil Retractors	591
Mosquito Haemostatic Forceps	161-163	Nail Excavators	125
Mosquito-Dandy Haemostatic Forceps	162	Nail Files	125
Mounting Frame for Rochard Abdominal Ret.	414	Nail Instruments	518, 519
Moure Adenoid Curettes	651	Nail Knives	123
Mouth Gags	562-569	Nail Nippers	120, 121
" Davis-Boyle	566	Nail Scissors	126, 127
" Denhardt	562	Nail Spatulas	124, 125
" Dingman	567	Nail Splitting Forceps	518
" Doyen-Collin	563	Nasal Cutting Forceps	623, 624
" Doyen-Jansen	563	" Cordes	624
" Featherstone	563	" Gruenwald	624
" Fergusson-Ackland	562	" Hajek-Claus	623
" Heister	563	" Hartmann	623, 624
" Jenning	563-565	" Middleton-Jansen	623
" Kilner-Dott	565	" Middleton-Struycken	623
" Kilner-Doughty	568	" Myles	624
" Kilner-Russel	565	" Ostrom	624
" Mason	562	" Schmeden	623
" Mason-Ackland	562	" Wagener	624
" McIvor	567	Nasal Knives	625, 626
" Molt	563	" Ballenger	626
" Negus	569	" Bruenings	626
" Oringer	565	" Converse	625
" Roser-Koenig	562	" Cottle	625
" Seemann-Seiffert	565	" Fomon	625
" Seemann-Seiffert (Self-Retaining)	565	" Freer	626
" Whitehead	565	" Halle	626
Mowlem Rhinoplastic Saws	640	" Heymann	625
Moynihan Haemostatic Forceps	166	" Joseph	625
Moynihan Intestinal Clamp Forceps	777		



# INHALTSVERZEICHNIS INDEX INDEX

	Page		Page
" Krieg	625	Needle Holders (cont'd)	
Nasal Polypus and Cutting Forceps	621-624	" Bozemann	249
" Blakesley	621	" Bozemann with T/C	264
" Blakesley (Lewis)	621	" Brown	243
" Bruenings	621	" Bruce Clark	244
" Luc	621	" Castroviejo with T/C	268
Nasal Polypus and Septum Forceps	619-622	" Collier	242, 247
" Craig	620	" Converse	241, 245
" Craig-Dominick	620	" Converse with T/C	259, 260
" Gruenwald (Jansen)	620	" Crile	250
" Hartmann	619	" Crile-Murray	243
" Heymann	620	" Crile-Wood	243
" Heymann-Knight	619	" Crile-Wood with T/C	259
" Killian	619	" De Bakey with T/C	260
" Knight	619	" Derf	242
" Littauer	619	" Derf with T/C	258
" Lubet-Barbon	619	" Doyen	242
" Noyes	620	" Eiselsberg	249
" Quire	620	" Eiselsberg-Mathieu	255
" Tilley	620	" Ermold	256
" Troeltsch	620	" Finochietto	247
" Westmacott	619	" Finochietto with T/C	264
Nasal Polypus Forceps	622	" Gillies	249
" Ferris-Smith	622	" Gillies with T/C	265
" Kofler	622	" Gillies-Slim	249
" Takahashi	622	" Gillies-Slim with T/C	265
" Watson-Williams	622	" Hagedorn	257
" Weil	622	" Halsey	241
Nasal Scissors	79, 80, 618	" Halsey with T/C	258
" Heymann	618	" Halstead	246
" Jackson	618	" Heaney	248
" Kirstein	618	" Hegar	241, 244
" Knight	618	" Hegar with T/C	261
" Seiler	618	" Hegar-Baumgartner	242
Nasal Snares	618	" Hegar-Baumgartner with T/C	258
" Krause	618	" Hegar-Vascular with T/C	263
" Krause-Voss	618	" Hodlick	243
" Lange-Wilde	618	" Hoesel	256
Nasal Speculum	613-618	" Hoesel with T/C	267
" Beckmann	614	" Hufnagel	245
" Cholewa	618	" Hufnagel with T/C	262
" Cottle	615, 616	" Intracardiac with T/C	263
" Fraenkel	617, 618	" Jacobson with T/C	268
" Hartmann	613	" Jamison	244
" Hartmann-Halle	613	" Janson	246
" Killian	615	" Julian	248
" Mod. Wein	613	" Julian with T/C	261
" Patton	617	" Kader-Mathieu	255
" Schwarz	613	" Kalt with T/C	268
" Sonnenschein	614	" Kilner	242
" Thudichum (Goldsmith)	617	" Kilner with T/C	259, 260
" Tieck-Halle	616	" Kirschner	250
" USA Model	617	" Koenig	251
" Vienna	614	" Langenbeck	251
" Voltolini	617	" Langenbeck with T/C	268
" Wiener Model	616, 617	" Langenbeck-Ryder with T/C	268
" Yankauer	615	" Lichtenberg	253
Naunton Morgan Needle Holders with T/C	265	" Lichtenberg with T/C	266, 267
Needle Holders	241-257	" Luethy-Beck	256
" Adson	243	" Luethy-Beck with T/C	267
" Arruga with T/C	267	" M. G. H.	244
" Axhausen	250	" Masing with T/C	258
" Baby-Crile-Wood with T/C	259	" Masson	246
" Boynton with T/C	267	" Masson with T/C	264
		" Masson-Luethy	246



	Page		Page
Needle Holders (cont'd)		Needle Holders Micro (cont'd)	
" Mathie-Kersten	253	" Gomel	274
" Mathieu	252, 254	" Jacobson	274, 274
" Mathieu-Kocher	252, 254	" Kalt	269
" Mathieu-Kocher with T/C	266	" Kalt-Arruga	269
" Mathieu-Slim with T/C	266	" Muller	272
" Mathieu-Stille	254	" Noyes	270
" Mathieu-Sverige	253	" Paton	271
" Mayo	256	" Potts-Smith	269
" Mayo-Hegar	241	" Reill	272
" Mayo-Hegar (Heaney) with T/C	261	" Rohrschneider	271
" Mayo-Hegar Seeley	243	" Stevens	269
" Mayo-Hegar with T/C	261	" Yasargil	275
" Mayo-Hegar-Seeley with T/C	261	Needles Discission	711
" Metzzenbaum	248	" Bowman	711
" Metzzenbaum-Mathieu	251	" Schweigger	711
" Metzzenbaum-Mathieu with T/C	266	Needles Ear	693
" Micro-Slim with T/C	263	" Barbara	693
" Mini-Ryder with T/C	262	" Rosen	693
" Naunton Morgan with T/C	265	Needles Hypodermic and Biopsy	240
" Neivert	242	" Dattner	240
" New Orleans	248	" Klima-Rosegger	240
" New Orleans with T/C	259	" Strauss	240
" Nivet with T/C	259	Needles Ligature	279-286, 744
" Olsen-Hegar	249, 250	" Brunner	280, 285
" Olsen-Hegar with T/C	265	" Clas-Eicken	285
" Rehbein-Baby	242	" Claus	285
" Rinne	255	" Cooper	280
" Ryder with T/C	262	" Craft	286
" Ryder-Vascular with T/C	262	" Da la Roza	744
" Sarot	244	" Deschamps	281, 282
" Sarot	247	" Dupuy-Weiss	284
" Sarot with T/C	260	" Durham	285
" Schoemaker-Loth	249	" Emmet	284
" Senning	246	" Falk	285
" Senning with T/C	259	" Hessberg	744
" Steinbach	255	" Jacobi	744
" Stille	255	" Jonesco	284
" Stratte	245	" Kocher	280
" Stratte with T/C	263	" Kronecker	280
" Swess Mod.	247	" Langenbeck	283
" Thomson-Walker (Bozemann)	248	" Nager	285
" Toennis	251	" Pauchet	284
" Toennis with T/C	268	" Payr	283
" Wagner	257	" Schmieden Dick	279
" Wangenstein	247	" Schmieden	279
" Wangenstein with T/C	264	" Syme	286
" Webster	241	" Trelat	285
" Webster with T/C	258	" Woodruff	744
" Wertheim	245	" Yankauer	284
" Wertheim	248	" Young	279
" Wertheim with T/C	263	" Young-Hryntschank	279
" with T/C	258-268	Needles Ophthalmic	710
" Wright (Derf) with T/C	258	" La Force	710
" Zweifel with T/C	267	" Levinson	710
Needle Holders with T/C	258-268	" Swiss Mod.	710
Needle Holders Micro	269-275	Needles Paracentesis	689-692
" Arruga	269, 272	" Buck	689, 690
" Barens	269	" Dench	689
" Barraquer	269, 270	" Dintenfass	689, 690
" Barraquer-Troutman	270	" Friesner	689
" Brock	272	" Gerzog	689
" Castroviejo-Kalt	269	" Gerzog-Sexton	691
" Castroviejo	271, 272, 274	" Jacobsen	690
" Castroviejo-Barraquer	274	" Lempert	691

	Page		Page
" Lucae	690	Neuro Knives	749, 762
" Lucae (Royce) <sup>TM</sup>	691	" Bucy	762
" Politzer	689-692	" Fisch	749
" Reiner	689	" Frazier	762
" Royce	689, 690	" Halle	762
" Sexton	689-691	" Jacobson	749
" Sprague	692	" Koos	749
" Troeltsch	691	" Kraus	749
Needles Reverdin	276-278	" Olivecrona	762
" Albaran	277	" Toennis	762
" Redon	278	" Yasargil	749
" Tierny	278	Neuro Micro Forceps	751, 752
Needles Rhinoplastic Yankauer	638	Neuro Scissors Yasargil	747, 748
Needles Storing Cases	972	Neuro Separators Woodson	762
Needles Tonsil	592-594	Neurosurgical Scissors	78
" Alexander	594	New Orleans Needle Holders	248
" Clas-Eicken	593	New Orleans Needle Holders with T/C	259
" Dupuy-Weiss	592	New Orleans Ophthalmic Scoops	715
" Durham	593	Newman Rectal Specula	798
" Eicken	593	News Retractor	306
" Falk	593	Nicaise Scarifying Knives	35
" Henton	592	Nicati Ophthalmic Chisels	710
" Hurd	593	Nicola Pituitary Curettes	760
" Nager	592	Nippers	120-122
" Rotter	593	Nippers Micro Crura	679
" Trelat	592	Nippers Micro Crura Mehmke	679
" Walker	593	Nippers Micro Malleus Lempert	679
Negus Haemostatic Forceps	178	Nippers Micro Malleus Wullstein	679
Negus Laryngoscopes	559	Niro Bone Cutters	485
Negus Mouth Gags	569	Nissen Dissecting and Ligature Forceps	181
Neivert Rhinoplastic Chisel	636	Nissen Gall Duct Forceps	856
Neivert Rhinoplastic Hooks	637	Nissen Rib Spreaders	528
Neivert Needle Holders	242	Nivet Needle Holders with T/C	259
Nelaton Anatomy and Post Mortem Knives	38	Norwood Swab Holder for Rectum	807
Nelson Tissue Forceps	141	Noto Dressing and Sponge Holding Forceps	219
Nelson Trocars	232	Noto Uterine Dressing Forceps	887
Nelson-Standard Trocars	230	Nott Vaginal Speculum	926
Neonatal and Pediatric Clamps	837-840	Novak Biopsy Curettes	907
" Castaneda	840	Novak-Schoeckaert Biopsy Curettes	907
" Cooley	838, 839	Noyes Micro Needle Holders	270
" Subramanian-Miniature	837	Noyes Nasal Polypus and Septum Forceps	620
Nerve Hooks	759, 760	Noyes Ophthalmic Iridectomy Scissors	742
" Crile	849	Noyes Ophthalmic Micro Scissors	740
" Dandy	759	Nuboer Suction Tubes	238
" Krayenbuhl	749	Nuemann Gum Scissors	86
" Scoville	760	Nugent Ophthalmic Strabismus Forceps	733
" Smithwick	759, 760	Nurses Scissors Flat Shanks	58
Nerve Root Elevators	763, 764	Nurses Scissors Round Shanks	56, 57
" Love	764	Nurses Scissors Slim Pattern	59
" Oldberg	764	Nurses Scissors with T/C	100, 101
" Scoville	764		
" Taylor	764	<b>O</b>	
Nerve-Preparation Dissecting Scissors	65	O'Conner Retractor	303
Nett Meniscectomy Knives	427	O'Brien Ophthalmic Fixation Forceps	729
Neubuser Tubal Seizing Forceps	899	O'Brien Suture Scissors	294
Neumann Scissors	47	Obstetrical Forceps	958-964
Neuro Douflex Mod. Dejerine Percussion Hammer	19	" Anderson	962
Neuro Elevators	761	" Bailey-Williamson	961
" Cushing	761	" Barends	962
" Dandy	761	" Barnes-Neville	964
" Hoen	761	" Barton	962
Neuro Hooklets	765	" Boerma	958
" Gillies	765	" De Lee	961
" Kilner	765	" Demelis	963



# INHALTSVERZEICHNIS INDEX INDEX

	Page		Page
Obstetrical Forceps (cont'd)		Operating Scissors	56-64
" Deweys	964	Ophthalmic Advancement Forceps	736
" Elliot	963	" Barens	736
" Haig-Fergusson	963	" Elschmig	736
" Hawks-Dennen	961	" Worth	736
" K. N. Dass	962	Ophthalmic Anterior Chamber Forceps Barraquer	735
" Kielland	960	Ophthalmic Capsular Forceps	729-732
" Kielland-Luikart	960	" Arruga	730
" Luikart	960	" Arruga-Nizetic	730
" Mc Lean	960	" Barraquer	731
" Mc Lean-Luikart	961	" Binkhorst	732
" Mc Lean-Rucker-Luikart	961	" Castroviejo	730
" Milne-Murray	963	" Choyce	731
" Murless	960	" Clayman	731
" Naegele	958	" Elschmig	730
" Piper	959	" Foerster	729
" Simpson	958, 963	" Fuchs	730
" Simpson-Braun	959	" Galin	731
" Simpson-Luikart	959	" Gill-Arruga	729
" Tarnier	964	" Gill-Fuchs	729
" Wrigley	958	" Green	731
Obwegesser Channelled Retractors	577	" Hess	730
Obwegesser Chin Retractors	577	" Hirschmann	732
Obwegesser Ramus Retractors	577	" Kalt	730
Obwegesser Retractor	337	" McPherson	731
Obwegesser Awls	586	" Pley	730
Obwegesser Bone Osteotomes	444	" Safar	731
Obwegesser Elevators	462, 463	" Schweigger	729
Ochsner Atrauma Cardiovascular Forceps	829	" Shepard	731
Ochsner Dressing Forceps	132	" Stock	729
Ochsner Probes	857	" Swiss Mod.	729
Ochsner Suture Forceps	292	" Terson	729, 731
Ochsner Trocars	232	Ophthalmic Chisels	710
O'Conner Ophthalmic Hooks	712	" Green	710
Oehler Tissue Forceps with T/C	158	" Knapp	710
Oelert Sternum Retractors	523	" Nicati	710
Oettingen Abdominal Retractor	404	" Rollet	710
Ogura Rhinoplastic Forceps	644	Ophthalmic Corneal Scissors Castroviejo	742
Oldberg Nerve Root Retractors	764	Ophthalmic Curettes	710
Oldberg Rongeurs	664	" Abadie	710
Olivecrona Amputation Saws	119, 754	" Alvis	710
Olivecrona Bone Rongeurs	496	" Davis	710
Olivecrona Brain Spatulas	763	" Ellis	710
Olivecrona Dura Dissectors	758	" Francis	710
Olivecrona Neuro Knives	762	" Plange	710
Olivecrona Neurosurgical Scissors	78	Ophthalmic Cyclodialysis Spatulas	714
Olivecrona Trigeminal Knives	34	" Culler	714
Olivecrona-Toennis (Scoville) Clip Applying Forceps	754	" Stock	714
Olivecrona Raspatories	457	" Suker	714
Ollier Retractor	320, 322, 323	" Weber	714
Ollier-Collin Retractor	323	" Wecker	714
Olsen-Hegar Needle Holders	249, 250	Ophthalmic Cystotomes	713
Olsen-Hegar Needle Holders with T/C	265	" Graefe	713
Olshausen Vaginal Retractors	942	" Meyer-Schwickerath	713
Ombredanne (Jackson) Towel Forceps	212	Ophthalmic Dissectors	718
Ombredanne Mallet	421	" Axenfeld	718
Operating Scalpels	25-32	" Lang	718
" Adams	32	Ophthalmic Enucleation Scissors	743
" Bergmann	30	" LaGrange	743
" Collin	31	" McGuire	743
" Dieffenbach	26, 30, 32	" Spencer	743
" Farabeuf	25	Ophthalmic Expression Forceps	736
" Halle	29	" Knapp	736
" Parker	32	" Prince	736
" Simon	31	Ophthalmic Fixation Forceps	727-729, 736

	Page		Page
Ophthalmic Fixation Forceps (cont'd)		" Gill-Hess	727
" Barraquer	728	" Graefe	725
" Barraquer (Colibri)	727	" Hess	726
" Barraquer-Katzin	727	" Mod. Bonn	726, 727
" Barraquer-Katzin (Colibri)	727	" Panas	726
" Barraquer-Llovera	728	" Stevens	725
" Castroviejo	727	Ophthalmic Keratomes	707
" Castroviejo-Colibri	728	" Barens	707
" Clark-Verhoeff	729	" Castroviejo	707
" Dermor-Pierse	736	" Jaeger	707
" Dermor-Pierse (Colibri)	736	" Jaeger-Grieshaber	707
" Elschnig	728	" Papst	707
" Graefe	728	" Rowland	707
" Green	728	" Weeker	707
" Kirby-Artur	728	" Weiner	707
" Maumenee-Colibri	728	Ophthalmic Knives	705-710
" O'Brien	729	" Anderson-Critchett	709
" Pierse	728	" Axenfeld	709
" Pierse-Colibri	728	" Barens	707
" Sauer	728	" Barkan	709
" Troutman (Colibri)	727	" Barraquer	706, 709
" Verhoeff	729	" Beer	706
" Waldau	729	" Berens	706
" Willard-Colibri	729	" Blascovics	709
Ophthalmic Forceps	725-738	" Bowman	708
Ophthalmic Gouges	710	" Burch	709
" Dix	711	" Castroviejo	706
" Kuhnt	710	" Castroviejo	707
" Meyer	710	" Curdy	709
" Walton	710	" Daily	709
" Walton (Todd)	710	" Dean	709
Ophthalmic Hooklets	712	" Desmarres	709
" Arruga	712	" Deutschmann	706
" Culler	712	" Elschnig	709
" Graefe	712	" Gill	709
" Green	712	" Girard Swan	710
" Jameson	712	" Graefe	706, 708, 709
" Smith	712	" Graefe-Arruga	706
" Stevens	712	" Guthrie	709
Ophthalmic Hooks	712	" Guyton-Lundsgaard	709
" Berens	712	" Haab	709
" Graefe	712	" Jaeger	707
" Guthrie	712	" Jaeger-Grieshaber	707
" Hirschmann	712	" Johnson	708, 709
" Holth	712	" Johnson-Took	709
" Mod. Bonn	712	" Knapp	708
" Mod. Tubingen	712	" Kuhnt	708
" O'Conner	712	" Lundsgaard	709
" Panas	712	" McReynolds	709
" Stevens	712	" Mod. Hamburg	708
" Tyrel	712	" Mod. Tubingen	708
" Wiener	712	" Papst	707
Ophthalmic Iridectomy Scissors	742	" Paton	709
" Castroviejo	742	" Paufigue	709
" Noyes	742	" Rowland	707
" Scheie-Westcott	742	" Sato	708
Ophthalmic Iris Forceps	725-727	" Scheie	709
" Bishop-Harman	725	" Schmith-Green	706
" Chandler	727	" Schnaudigl	708
" Elliot	726	" Searcy	709
" Fischer	726	" Sichel	708
" Fischer-Art	726	" Took	709
" Foerster	726	" Troutman	710
" Fuchs	727	" Walker-Lee	709
" Gill	727	" Weber	708



# INHALTSVERZEICHNIS INDEX INDEX

	Page		Page
Ophthalmic Knives (cont'd)		Ophthalmic Scoops (cont'd)	
" Weeker	707, 709	" Wells	715
" Weiner	707	Ophthalmic Skeleton Forceps Kuhnt	736
" Wheeler	706	Ophthalmic Spatulas	714
" Ziegler	708	" Castroviejo	714
Ophthalmic Lens Expressors	713	" Dastoor	714
" Amenabar	715	Ophthalmic Speculum	702, 703
" Barens	713	" Agricola	703
" Wilmer-Bagley	713	" Arruga	703
Ophthalmic Micro Scissors	738-743	" Axenfeld	703
" Aebli	739	" Barraquer (Colibri)	702
" Barraquer	738	" Bowman	702
" Castroviejo	739	" Cook	703
" Katzin	739	" Critchett	702
" Katzin-Barraquer	739	" Goldstein	703
" McClure	740	" Graefe	702
" McPherson-Vannas	741	" Guyton-Park	703
" Micro	740	" Knapp-Clark	702
" Noyes	740	" Lancaster	702
" Troutman	738	" Lister-Burch	702
" Troutman-Barraquer	739	" Mellinger	703
" Troutman-Castroviejo	738, 740	" Mellinger-Axenfeld	703
" Vannas	741	" Mellinger-Beard	703
" Vannas Mod. Tubingen	741	" Muller	703
" Wecker	740	" Murdock	703
Ophthalmic Muscular Forceps	734, 735	" Park	703
" Berke	735	" Park-Maumenee	703
" Blascovics	735	" Pley	702
" Fink-Jameson	735	" Sauer	702
" Jameson	734	" Stevenson	703
" Prince	735	" Weiss	702
" Sattler	735	" Ziegler	702
Ophthalmic Needles	710	Ophthalmic Spud	710, 711
" La Force	710	" Luer	710
" Levinson	710	" Standard	710
" Swiss Mod.	710	Ophthalmic Strabismus Forceps	733, 734
Ophthalmic Orbit Spatulas Sautter	713	" Barraquer Modif.	733
Ophthalmic Radial Keratomy Forceps	737	" Bonaccolto	733, 734
" Arrowsmith	737	" Bonn	733
" Bores	737	" Dastoor	734
" Kremer	737	" McCullough	733
" Rubman-Bores	737	" McPherson	734
Ophthalmic Rasps	714	" Mod. Tubingen	733
Ophthalmic Retractors	713	" Nugent	733
" Arruga	713	" Paufique	734
" Aubaret	713	" Schaaf	734
" Axenfeld	713	" Truthman-Rectus	734
" Fink	713	" Tubingen	733
" Knapp	713	Ophthalmic Suture Forceps	732, 733
" McGannan	713	" Alabama-University	732
" Pauls	713	" Castroviejo	733
" Rollet	713	" Dastoor	733
Ophthalmic Scoops	715	" Falcao	732
" Art	715	" Girad	733
" Daviel	715	" Guist	732
" Elschmig	715	" Kronfeld	732
" Graefe	715	" Kronfeld (Panas)	732
" Hess	715	" Moorfield	732
" Knapp	715	Ophthalmic Tenotomy Scissors	741
" Lewis	715	" Castroviejo	741
" New Orleans	715	" Fine	741
" Snellen	715	" McPherson-Westcott	741
" Troutman	715	" Westcott	741
" Verhoeff	715	Ophthalmic Tissue Forceps	732
" Weber	715	" Lester	732



# INHALTSVERZEICHNIS INDEX INDEX

	Page		Page
Ophthalmic Tissue Forceps (cont'd)		Papillotomes	863
" Schmidt-Rimpler	732	Pappen-Blalock Atrauma Aortic Clamps	841
Ophthalmic Trephines	721, 722	Papst Ophthalmic Keratomes	707
" Arruga	721	Papst Ophthalmic Knives	707
" Castroviejo	721, 722	Paracentesis Needles	689-692
" Elliot	721	" Buck	689, 690
" Grieshaber	721	" Dench	689
" Stephenson	721	" Dintenfass	689, 690
Ophthalmology Operating Sets	745, 746	" Friesner	689
Ophthalmoscope Set	14	" Gerzog	689
Organ Holding Forceps	179, 180	" Gerzog-Sexton	691
" Chaput	179	" Jacobsen	690
" Collin	179	" Lempert	691
" Tuffier	179	" Lucae	690
Original Steinhauser Instruments	669, 670	" Lucae (Royce)	691
Original-Jackson Broncho-Esophagoscopy Forceps	601, 603	" Politzers	689-692
Oringer Mouth Gags	565	" Reiner	689
Osteotomes Bone	434-447	" Royce	689, 690
" Bergmann	441	" Sexton	689-691
" Brunetti	442	" Sprague	692
" Cottle	438	" Troeltsch	691
" Hibbs	436, 437	Parametrium Scissors with T/C	99
" Hoke	436	Parham Bone Wire Guides	548
" Lambotte	439, 443	Park Eye Speculum	703
" Lexer	444, 447	Park Rectal Specula	797
" Mannerfelt Modif.	435	Parker Operating Scalpel	32
" Mini-Lambotte	442, 443	Parker Retractor	377
" Mini-Lexer	443	Parker-Kerr Intestinal Clamp Forceps	776
" Moberg	437	Parker-Langenbeck Retractor	377
" Murphy	438	Parker-Mott Retractor	377
" Obwegesser	444	Park-Maumenee Eye Speculum	703
" Sheehan	438	Parry-Cooley Atrauma Cardiovascular Forceps	834
" Smith-Petersen	442	Partsch Bone Chisels	435
" Stille	440	Partsch Intestinal and Stomach Clamp Forceps	780
" U. S. Army	439	Partsch Mallet	423
" Virchow	441	Partsch Mod. Lange Raspatories	451
Osteotomes Rhinoplastic	634, 635	Partsch Raspatories	451
" Cottle	634, 635	Passow Tampers	448
" Sheehan	635	Paton Micro Needle Holders	271
" Walter	634	Paton Ophthalmic Knives	709
Ostrom Nasal Cutting Forceps	624	Paton Transplant Forceps	721
O-Sullivan-O'Conner Abdominal Retractor	409	Patton Nasal Speculum	617
O-Sullivan-O'Conner Vaginal Speculum	941	Pauchet Ligature Needles	284
Otoscopes	12-14	Paufique Ophthalmic Knives	709
Overholt Dissecting and Ligature Forceps	181	Paufique Ophthalmic Strabismus Forceps	734
Overholt-Geissendoerfer Dissecting and Ligature Forceps	185	Paul Retractor	309
Overholt-Mixter Dissecting and Ligature Forceps	182	Pauls Ophthalmic Retractors	713
Ovum and Placenta Forceps	944-950	Paulsen Raspatories	453
" Corey	950	Payr Ligature Needles	283
" Kelly	948	Payr Intestinal and Stomach Clamp Forceps	780
" Kranz	950	Payr Ligature Conductors	289
" Lewkowitz	949	Payr-Baby Intestinal and Stomach Clamp Forceps	780
" Mc Clintock	948	Pean Haemostatic Forceps	169, 171, 172
" Saenger	949	Pean Trocars	232
" Winter	944-948	Pean-Dixon Haemostatic Forceps	169
Ovum Curettes	952	Pean-Nippon Haemostatic Forceps	170
" Cuzzi	952	Pederson Vaginal Speculum	920
" Pestalozza	952	Pediatric and Neonatal Clamps	837-840
		" Castaneda	840
<b>P</b>		" Cooley	838, 839
Palmer Fracture Pins	545	" Subramanian-Miniature	837
Panas Ophthalmic Hooks	712	Peers-Bertram Towel Forceps	212
Panas Ophthalmic Iris Forceps	726	Peet Splinter Forceps	147
Paparella Ear Speculum	682	Peiper-Beyer Bone Rongeurs	498
		Pelkmann Dressing and Sponge Holding Forceps	220



# INHALTSVERZEICHNIS INDEX INDEX

	Page		Page
Pelkmann Gall Stone Forceps	859	Pituitary Curettes	760, 761
Pelkmann Uterine Dressing Forceps	886	" Cone	761
Pelvimeters	954, 955	" Nicola	760
" Breisky	955	" Ray	760
" Collin	954	Placenta and Ovum Forceps	944-950
" Collyer	955	" Corey	950
" De Lee	954	" Kelly	948
" Schneider	954	" Kranz	950
" Thole	955	" Lewkowitz	949
Pelvis Retractors	800	" Mc Clintock	948
Penfield Dura Dissectors	757, 758	" Saenger	949
Penis Clamps	871, 872	" Winter	944-948
Penner Nail Forceps	519	Placenta Pan	988
Pennington Septum and Periosteal Elevators	629	Placenta Plate	988
Percussion Hammers	16-19	Plange Ophthalmic Curettes	710
" Babinski	16	Plaster Breakers	112
" Berliner	18	" Farabeuf	112
" Buck	17	" Mason	112
" Dajerine	18	" Wolff	112
" Drivers Douflex Mod. Dejerine	19	Plaster Knives	114
" Ebstein	18	" Esmarch	114
" Mobile	17	" Hopkins	114
" Neuro Douflex Mod. Dejerine	19	" Korte	114
" Rabiner	16	" Reiner	114
" Taylor	17	Plaster Lifter	115
" Troemner	19	" Kaulich	115
" Traube	18	" Wigmore	115
" Troemner Simplex	19	Plaster Shears	109-111
" Vernon	17	" Bruns	111
Perforators Naegele	950	" Commander	110
Perforators Smellie	950	" Guy	111
Perham Bone Holding Clamp Forceps	517	" Haglund-Stille	111
Periosteal Elevators	627-631	" Hercules	111
" Cottle	631	" Moleskin	111
" Cottle-McKenty	631	" Seutin	110
" Killian	631	" Stille	109, 110
Peritoneal Clamp Forceps	204-206	" Stille-Mini	109
" Baby-Mikulicz	204	Plaster Spreaders	113
" Faure	205	" Beeson	113
" Mikulicz	204-206	" Haglund-Stille	113
" Schindler	206	" Henning	113
Perkins Retractor	384	" Knorr	113
Perman Abdominal Retractor	405	" Walton	113
Perman Bone Holding Forceps	505	Plate Scissors	55
Perthes Hand Drills	540	Playfair Cotton Holders	901
Pertuiset Carotid Clamps	855	Plester Ear Knives	688
Pess Lid Everters	704	Plester Retractor	383
Pestalozza Ovum Curettes	952	Plester Suction Tubes	236
Peterson Broncho-Esophagoscopy Forceps	602	Pley Eye Speculum	702
Petri Dishes	983	Pley Ophthalmic Capsular Forceps	730
Phaneuf Hysterectomy Forceps	193	Pliers Flat Nose	549-551
Phillip Cotton Dispenser	989	Pliers Steinhauser	670
Phillips Cilia Forceps	150	Pliers Wire Cutting	552-555
Phillips Screw Drivers	542, 543	" Angle	552
Physician Splinter Forceps	148	" Reill	553
Picks Ear Barbara	693	" with T/C	554, 555
Pierce Septum and Periosteal Elevators	628	Pocket Instrument Set	295-297
Pierce Trocars	230	Politzer Ear Knives	689
Pierse Ophthalmic Fixation Forceps	728	Politzer Ear Speculum	680
Pierse-Colibri Ophthalmic Fixation Forceps	728	Politzers Paracentesis Needles	689-692
Piffard Lucas Curettes	765	Polloson Retractor	361
Pinard Stethoscope	8	Polypus Ear Forceps	672, 673
Piper Obstetrical Forceps	959	" Bellucci	672
Pitha Dressing and Washing Forceps	222	" Buck	672
Pitha Foreign Body Forceps	874	" Hartmann	672, 673



INVENT GERMANY

# INHALTSVERZEICHNIS INDEX INDEX

	Page		Page
Polypus Ear Forceps (cont'd)		Probes Trabecular (cont'd)	
" Hartmann-Noyes	673	" Harms	719
" Hartmann-Weingartner	673	" Mackensen	719
" Hartmann-Wullstein	673	Proctoscopes	798, 799
" Littauer	672	Prostatic Retractors	869, 870
" Mirco	673-676	" Proust	870
" Quire	672	" Young	869, 870
" Struempel	673	Prostectomy Atrauma Forceps Millin	871
Pool Suction Tubes	234	Prostectomy Forceps	871
Poppen Suction Tubes	235	" Millin	871
Post Mortem Knives	36-40	Proust Prostatic Retractors	870
Pott (Johns-Hopkins) Aorta Clamps	849	Providence-Hospital Haemostatic Forceps	163
Pott Anatomy and Post Mortem Knives	38	Punch Forceps	597
Potts Atrauma Cardiovascular Forceps	821, 822	" Hartmann	597
Potts Sternum Scissors	523	" Ruault	597
Potts Vessel Clamps	854, 855	" Ruault-Collin	597
Potts-De Martel Scissors with T/C	102	" Schmeden	597
Potts-De Martel Vascular Scissors	75	Punches	654-662
Potts-Glover Vessel Clamps	854	" Beyer	657
Potts-Satinsky Vena Cava Clamps	852	Punches Canaliculus	722
Potts-Satinsky Vessel Clamps	855	" Haitz	722
Potts-Smith Aorta Clamps	849	" Holth	722
Potts-Smith Dressing Forceps	135	" LaGrange	722
Potts-Smith Dressing Forceps with T/C	159	Punches Citelli	657
Potts-Smith Micro Needle Holders	269	Punches Colclough	659, 660
Potts-Smith Scissors with T/C	88	Punches Colclough (Richter)	659
Potts-Smith Tissue Forceps	135	Punches Dermal Keys	766
Potts-Smith Vascular Scissors	72, 855	Punches Ferris-Smith	662
Powder Blower Kabierske	701	Punches Ferris-Smith-Kerrison	654-656
Pozzi Uterine Tenaculum Forceps	878, 881	Punches Hajek-Kofler	657, 658
Pozzi-Palmer Uterine Tenaculum Forceps	881	Punches Kerrison	654-656
Pratt Haemostatic Forceps	169	Punches Kofler	658
Pratt Rectal Probes	803	Punches Schlesinger	661
Pratt Rectal Specula	797	Punches Sypert	662
Pratt Rhinoplastic Sharp Curettes	647	Puncturing Forceps	952
Pratt Uterine Dilators	905	" Herff	952
Pratt Uterine Tenaculum Forceps	880	" Iowa	952
Pratt-Smith Haemorrhoidal Forceps	800	Putti Bone Files	474
Price-Thomas Bronchus Forceps	536	Pye-Smith (Harrison) Sterilizing Forceps	966
Prince Cauteries	714		
Prince Ophthalmic Expression Forceps	736	<b>Q</b>	
Prince Ophthalmic Muscular Forceps	735	Quervain Abdominal Retractor	405
Prince Tonsil and Nasal Scissors	80	Quervain Bladder Retractor	416
Probes	857	Quervain Bone Levers	464
" Desjardins	857	Quervain Rib Spreaders	533
" Hajek	857	Quinby Scissors	47
Probes Lachrymal	719, 720	Quire Ear Polypus Forceps	672
" Bowmann	719, 720	Quire Nasal Polypus and Septum Forceps	620
" Bowmann (Williams)	720	Quisling Rhinoplastic Hammers	647
" Galezowsky	720		
" Rolf	719	<b>R</b>	
" Ziegler	719	Rabiner Percussion Hammer	16
Probes Mayo	857	Ragnell (Kilner) Scissors with T/C	87
Probes Micro	750	Ragnell Dissecting Scissors	69
" Jacobson	750	Ragnell-Davis Retractor	308
" Yasargil	750	Ralk (Virtus) Splinter Forceps	147
Probes Mixer	857	Ralk Hand Drills	539
Probes Moynihan	857	Ralk Splinter Forceps	147
Probes Ochsner	857	Ramley Dressing and Sponge Holding Forceps	217
Probes Rectal	803	Ramsay Dressing Forceps	132
" Brodie	803	Ramsay Tissue Forceps	132
" Buie	803	Ramus Retractors	577
" Lockhart-Mummary	803	Randall Biopsy Curettes	907
" Pratt	803		
Probes Trabecular	719		



	Page		Page
Randall Kidney Stone Forceps	864, 865	Razor Blade Removing Forceps	24
Raney Clip Applying Forceps	754	Razors	42
Rankin-Crile Haemostatic Forceps	164	Reamer Forceps Adson	540
Rankin-Kelly Haemostatic Forceps	164	Recamier (Sims) Uterine Wash Curettes	916
Rasmus Retractor	338	Recamier Uterine Curettes	909, 910
Raspatories	449-460	Rectal Cannulas Katzenstein	807
" Adson	457	Rectal Probes	803
" Alexander	455	" Brodie	803
" Bristow	458	" Buie	803
" Buchs	460	" Lockhart-Mummery	803
" Caspar	457	" Pratt	803
" Cobb	460	Rectal Scissors	801
" Cohen	453	" Lloyd-Davis (Goligher's)	801
" Cottle	454, 456	" Miller	801
" Cushing	450, 452	" Stelzner	802
" Doyen	456	Rectal Specula	795-799
" Ear Lempert	700	" Barr	797
" Farabeuf	449	" Bensaude	798
" Farabeuf-Collin	449	" Brinkerhoff	797
" Freer	452, 453	" Cook	795
" Freer-Yasargil	453	" Czerny	795
" Halle	452	" Hirschmann	798
" Hoen	450	" Ives-Fransle	798
" Howarth	454	" Kelly	799
" Hylin	457	" Killian	795
" Jansen	460	" Mathieu	795
" Joseph	452	" Newman	798
" Kahre-Williger	450	" Park	797
" Key	458	" Pratt	797
" Killian	453	" Ricord	795
" Kirrmission	451	" Roschke	795
" Koenig	451	" Schulze-Bergmann	796
" Kramer	455	" Sims	796
" Lambotte	449	" Smith-Buie	797
" Landolt	456	Redon Reverdin Needles	278
" Langenbeck	451	Reese Ophthalmic Trachoma Forceps	736
" Lempert	454	Rehbein (Mod. Bremen) Rib Spreaders and Contractors	535
" MacDonald	453	Rehbein-Baby Needle Holders	242
" Mannerfelt Modif.	458	Rehn Retractor	360
" Mathieu	457	Rehn Skin Grafting Knives	43
" Matson	458	Reichert Epiglottis Retractors	583
" McKenty	449	Reich-Nechtow Biopsy Curettes	907
" Mead	452	Reiger-Sprague Stethoscope	7
" Micro Yasargil	750	Reill Bone Holding Forceps	504
" Molt	452	Reill Micro Needle Holders	272
" Muhling	457	Reill Wire Cutting Pliers	553
" Olivecrona	457	Rein Atrauma Cardiovascular Forceps	828
" Partsch	451	Reiner Paracentesis Needles	689
" Partsch Mod. Lange	451	Reiner Plaster Knives	114
" Paulsen	453	Reinhoff-Finocchio Rib Spreaders	527
" Schneider	454	Resano Atrauma Sigmoid Anastomosis Forceps	792
" Schneider-Sauerbruch	454	Resano Vascular Scissors	77
" Sedillot	451	Retractors	298-419
" Seldin	454	" Adson	305, 386, 387, 389, 390
" Semb	455	" Adson-Baby	385
" Sewall	452	" Agricola	379
" Trelat	451	" Albarran	357
" Wagner	459	" Allison	370
" Williger	450	" Allison Spatulas	370
Rasps Ophthalmic	714	" Allport	380
Raverdino Lachrymal Dilators	720	" Alm	380
Ray Kidney Stone Forceps	865	" Anal	797, 798
Ray Pituitary Curettes	760	" Anderson-Adson	384
Rayne Retractor	338	" Aorta Cooley	850
Razor Blade Holder and Breakers	24	" Arruga	713

	Page		Page
Retractors (cont'd)		Retractors (cont'd)	
" Aubaret	713	" Finsen	379, 608
" Aufricht	638	" Finsen Modif.	608
" Axenfeld	713	" Fisch	304
" Baby-Collin	401	" Fomon	311
" Baby-Roux	375	" Frazier	305
" Baby-Senn-Miller	308	" Freer	304, 638
" Backmann-Eaton	390	" Fritsch	350, 351
" Barraquer	379	" Gelpi	397, 942
" Barsky	306	" Gelpi-Baby	396
" Beckmann	390	" Gelpi-Loktite	396, 397
" Beckmann-Adson	391	" Gelpi-Seiletz	396
" Beckmann-Bayonet	392	" Genito-Urinary	871, 872
" Bellucci	384	" Genito-Urinary Stockmann	871
" Bergmann	303	" Genito-Urinary Strauss	872
" Billroth	325	" Genito-Urinary Young	871
" Bladder Hryntschak	869	" Gifford-Jansen	381
" Blount	333	" Gillies	304
" Bose	303, 379, 608	" Gil-Vernet	299
" Breisky	351	" Goelet	352
" Brom	307	" Goodyear	591
" Brunner	355-358	" Graefe	303, 307
" Buchs	341	" Greene	341
" Buckley	379	" Guthrie	303
" Canny Ryall	369	" Haberer	374
" Caspar	307, 342	" Handte	301
" Charnley	393	" Harrington	343, 362, 363
" Cheek and Lip	572, 573	" Harrington-Baby	362
" Cheek and Lip Shuman	573	" Harrington-Pemberton	362
" Cheek and Lip Sternberg	572	" Harvey Jackson	391
" Cloward	385, 388, 398, 399	" Heaney	338, 942
" Cloward Modif.	398	" Henley	388
" Cloward-Hoen	400	" Henner (Lempert)	381
" Cloward-Lumber	400	" Hibbs	336
" Collin	377, 402	" Hoen	400
" Collin-Hartmann	378	" Hoesel	346
" Collin-Loktite	402	" Hofer	591
" Converse	305, 638	" Holmann	368
" Cooley	367	" Holzbach	403
" Cope	308	" Howell	326
" Coryllos	359, 360	" Humby	306
" Cottle	299, 303, 635, 637	" Inge	401
" Courty	392	" Intra Oral Retractors	574-576
" Courty-Fontaine	392	" Israel	322
" Crawford	346	" Iterson	607
" Crile	302, 305, 375	" Jackson	303, 308, 609
" Crotti	393	" Jackson Burrows	396
" Cushing	298, 299, 306	" Jaeger	305
" Cushing Kocher	299, 301	" Jansen	381
" Czerny	333, 376	" Joll (Friedman)	397
" Darling	395	" Joll (Friedman)	942
" Dartigues	395	" Joseph	304
" Davidson	363	" Kader	372
" De Bakey	396	" Kallmorgen	940
" Deaver	364-367	" Kelly	348, 353
" Deaver-Baby	366	" Kilner	304, 305, 638
" Desmarres	300	" Kirsch	342
" Dockhorn	344	" Klapp	313
" Doyen	349, 351, 352, 942	" Kleinert-Kutz	306
" Doyen-Stille	343	" Knapp	309, 310, 713
" Emmet	304	" Knighton	394, 399
" Epiglottis Reichert	583	" Kocher	301, 314, 318-320, 330, 334, 344, 374, 393
" Farabeuf	376	" Kocher-Langenbeck	331
" Farr	395	" Kocher-Wagner	345
" Fink	713	" Koenig	300

	Page		Page
Retractors (cont'd)		Retractors (cont'd)	
" Korte	371, 317	" Oelert	523
" Korte-Wagner	319	" Ollier	320, 322, 323
" Kramer	342	" Ollier-Collin	323
" Krayenbuhl	307	" Olshausen	942
" Kristeller	935-938	" Parker	377
" Kristeller (Wiener Modl)	939	" Parker-Langenbeck	377
" Kuemmel	371	" Parker-Mott	377
" Kuttner	380	" Paul	309
" Lahey	326, 333	" Pauls	713
" Lahey Clinic	305	" Perkins	384
" Lampert	318	" Plester	383
" Lancaster	380	" Polloson	361
" Landon	940	" Proust	870
" Lane	376	" Ragnell-Davis	308
" Lange	304	" Rasmus	338
" Langenbeck	327-329, 332, 337	" Rayne	338
" Langenbeck Mannerfelt Modif.	301	" Rehn	360
" Langenbeck-Green	326	" Reverdin	374
" Langenbeck-Mannerfelt Modif.	326	" Ricard	403
" Legueu	344	" Richardson	347, 348
" Leriche	372	" Richardson-Eastman	347
" Lid	704	" Richter	397, 942
" Lid Conway	704	" Robb-Lewis	591
" Lid Desmarres	704	" Rollet	310, 713
" Lid Groenholm	704	" Rose	302, 345, 376, 609
" Little	301	" Rowe	338
" Logan	379	" Rugby	389
" Lothrop	591	" Sauer	380
" Love	302, 591	" Sauerbruch	328, 332, 358
" Love (Morse)	302	" Scalp Contour	383
" Lucae	306	" Schoenborn	301, 608
" Luer	302, 308, 375, 609	" Schulz	342
" Lukens	308, 609	" Seidl	938
" Machatt	310	" Semb	333
" Mannerfelt Modif.	300, 301, 308-310	" Senn-Green	308
" Markham-Meyerding	394	" Senn-Miller	308
" Masing	298, 637	" Sexton	393
" Mathieu	376	" Shambaugh	381
" Mayo-Adams	386, 395	" Simon	304, 335, 941
" Mayo-Collin	377	" Smillie	336
" McGannen	713	" Sofield	378
" Meillinger	380	" Spatulas Allison	370
" Meyerding	313, 339, 394	" St. Marks	369
" Middeldorpf	340	" Steinhauer	669, 670
" Mikulicz	320, 353, 354, 373	" Sternberg	378
" Milligan	382	" Stevenson	381
" Millison	382	" Straight	305
" Mini-Langenbeck	326	" Strandell-Stille	313
" Mini-Roux	376	" Toennis	304
" Miskimon	388	" Tubinger Mod.	386, 941
" Model Tubingen	336	" Tuffier	344, 374
" Moldestad	304	" Venenhaken Brom	313
" Morris	352	" Volkmann	311, 314-317
" Morrison Davies	355	" Wagner	307
" Mueller	379	" Wagner-Jansen	381
" Muller	305	" Wassmund	320
" Murphy	321	" Weedra	607
" Neger	591	" Weinberg	359
" News	306	" Weitlaner	383-385
" O'Conner	303	" Weitlaner-Baby	382
" Obwegeser	337	" Weitlaner-Beckmann	389
" Obwegeser Channelled	577	" Weitlaner-Loktite	382
" Obwegeser Chin	577	" Weitlaner-Original	383
" Obwegeser Ramus	577	" Weitlaner-Wulstein	382



# INHALTSVERZEICHNIS INDEX INDEX

	Page		Page
" Wieder	591	Rhinoplastic Hooks (cont'd)	
" Williger	312	" Joseph	638
" Young	869, 870	" Neivert	637
" Zenker	322	Rhinoplastic Instruments	633-644
Reverdin Needles	276-278	" Joseph	642
" Albaran	277	Rhinoplastic Measuring Device Joseph	640
" Redon	278	Rhinoplastic Needles Yankauer	638
" Tierny	278	Rhinoplastic Osteotomes	634, 635
Reverdin Retractor	374	" Cottle	634, 635
Reverdin Spatulas	374	" Sheehan	635
Reynolds Scissors	47	" Walter	634
Reynolds-Jameson Scissors	47	Rhinoplastic Retractors	635, 637, 638
Rhinoplastic Chisel	633-636	" Aufricht	638
" Anderson-Neivert	636	" Cottle	635, 637
" Cinelli	636	" Converse	638
" Cottle	634	" Freer	638
" Fomon	636	" Kilner	638
" Freer	633	" Masing	637
" McIndoe	636	Rhinoplastic Rongeurs Kressner	642
" Metzzenbaum	633	Rhinoplastic Saws	640, 642
" Moberg	636	" Cottle	642
" Neivert	636	" Joseph	640
" Rubin	633, 636	" Mowlem	640
" Silver	635	Rhinoplastic Scissors	645, 646
" Swall	633	" Aufricht	646
" Walter	634	" Castanares	645
Rhinoplastic Files	639-641	" Cinelli	646
" Aufricht	639	" Converse	645
" Converse	641	" Cottle	645
" Cottle	639	" Cottle (Bulldog)	645
" Fomon	641	" Fomon	646
" Gallaher	639-641	" Heymann	646
" Joseph	639, 640	" Joseph	646
" Lewis	639	" Littler	645
" Maltz	639	" McIndoe	645
" Masing	640	" Seiler	646
" Wiener	640	" Taylor	645
Rhinoplastic Forceps	642-645	Rhinoplastic Sharp Curettes	647
" Asch	642	" Coakley	647
" Cottle	644	" Dingman	647
" Cottle-Masing	643	" Faulkner	647
" Cottle-Walsham	643	" Pratt	647
" Fox	644, 645	Rib Shears	520-522
" Guillen	644	" Baer	522
" Hinderer	644	" Bethune	522
" Masing	644	" Brunner	521
" Ogura	644	" Collin	520
" Rubin	642	" Coryllos-Bethune (Collin)	522
" Tschoepe	643	" Giertz-Stille	521
" Walsham	643	" Gluck	520
" Walsham (Universal)	643	" Lebsche	521, 522
Rhinoplastic Gouges	633	" Sauerbruch	521
" Freer	633	" Sauerbruch-Britsch	522
" Killian	633	" Sauerbruch-Frey	521
" Killian-Claus	633	" Schuchardt	521
Rhinoplastic Hammers	647	" Stille	520
" Cottle	647	Rib Spreaders	524-535
" Guillen	647	" Ankeney	533
" Quisling	647	" Brasstad	532
Rhinoplastic Hooks	637, 638	" Burford	529
" Cottle	637	" Castaneda	532
" Cottle-Neivert	637	" Cooley	524, 531
" Fomon	637, 638	" De Bakey	527, 528
" Freer	638	" Finochietto	526, 529-532
		" Finochietto-Baby-Haight	531



# INHALTSVERZEICHNIS INDEX INDEX

	Page		Page
Rib Spreaders (cont'd)		Rongeurs Bone (cont'd)	
" Finochietto-Infant	531	" Blumenthal	495
" Haight	525	" Bohler	497
" Hertzler	527	" Cleveland	494
" Lillianthal	533	" Cohen	491
" Mini Thoracotomy	532	" Cottle-Jansen	493
" Morse	524	" Echlin	499
" Nissen	528	" Fisch	492
" Quervain	533	" Freidmann	491
" Reinhoff-Finochietto	527	" Frykholm	499
" Sauerbruch	533	" Geiger	498
" Sellors	526	" Guleke	496
" Sick Children Hospital	525	" Hakansson	495
" Struch	525	" Jansen	493
" Tuffier	526	" Kleinert-Kutz	495, 498
Rib Spreaders and Contractors	535	" Leksell	500
" Bailey	535	" Lempert	494, 496
" Bailey-Baby	535	" Luer	492
" Crafoord	535	" Luer-Freidmann	491
" Lemmon	535	" Markwalder	502
" Rehbein (Mod. Bremen)	535	" Marquardt	497
" Sellors	535	" Mayfield	498
Ricard Retractor	403	" Mead	494, 495
Richardson Retractor	347, 348	" Mini-Freidmann	491
Richardson-Eastman Retractor	347	" Olivecrona	496
Richnau-Holmagren Ear Speculum	682	" Peiper-Beyer	498
Richter Operating Scissors	60	" Rottgen-Ruskin	497
Richter Retractor	397	" Ruskin	497
Richter Vaginal Retractors	942	" Ruskin-Mini	497
Ricord Rectal Specula	795	" Sauerbruch-Coryllos	502
Ring Cutters	519	" Sauerbruch-Stille	502
" Smith	519	" Schell	496
" Walton	519	" Semb	499
Rinne Needle Holders	255	" Smith-Petersen	500
Ritter-Halle Probes	653	" Stellbrink	491
Rntne Hospital Broncho-Esophagoscopy Forceps	601	" Stille	500
Robb Intima Spatula and Dilator	847	" Stille-Leksell	499
Robb Tonsil Knives	587	" Stille-Luer	501
Robb-Lewis Tonsil Retractors	591	" Stille-Ruskin	501
Roberts Haemostatic Forceps	174	" Sybert	501
Robertson Tonsil Knives	588	" Trotter	494
Roberts-Standard Trocars	230	" Universal	494
Robin Towel Forceps	212	" Zaufal	495
Robin-Masse Abdominal Retractor	404	" Zaufal-Jansen	498
Rochard Abdominal Retractor	414	Rongeurs	662-668
Rochers-Pean Haemostatic Forceps	168	" Caspar	664, 667, 668
Rochester Dressing Forceps	138	" Cloward	664
Rochester-Carmalt Haemostatic Forceps	174	" Cushing	663
Rochester-Mixter Bronchus and Gall Duct Clamps	187	" Ferris-Smith-Cushing	662
Roeder Ligature Carriers	590	" Kraemer	666
Roeder Towel Forceps	212	" Landolt	665
Roger Hysterectomy Atrauma Forceps	201	" Love-Gruenwald	663
Roger Septum and Periosteal Elevators	629	" Oldberg	664
Rogge Sterilizing Forceps	965	" Rhinoplastic Kressner	642
Rohrschneider Micro Needle Holders	271	" Schlesinger	664
Rolf Lachrymal Probes	719	" Spurling	663
Rollet Ophthalmic Chisels	710	" Sybert	666
Rollet Ophthalmic Retractors	713	" Wagner	665
Rollet Retractor	310	" Weil-Blakesley	663
Rongeurs Bone	491-502	" Yasargil	665
" Adson	496	Rooke Tissue Forceps	132
" Alexander	493	Roosevelt Intestinal and Stomach Clamp Forceps	782
" Bacon	494	Roschke Rectal Specula	795
" Bane	496	Rose Retractor	302, 376
" Beyer	492, 498	Rose Tracheal Retractors	609

	Page		Page
Rosen Dissectors	694	Sauerbruch Rib Shears	521
Rosen Ear Knives	688	Sauerbruch Rib Spreaders	533
Rosen Ear Needles	693	Sauerbruch Sterilizing Forceps	967
Roser Ear Loops	697	Sauerbruch-Britsch Rib Shears	522
Roser-Koenig Mouth Gags	562	Sauerbruch-Coryllos Bone Rongeurs	502
Ross Retractor	345	Sauerbruch-Frey Rib Shears	521
Rotter Tonsil Needles	593	Sauerbruch-Stille Bone Rongeurs	502
Rottgen-Ruskin Bone Rongeurs	497	Saupe Cilia Forceps	149
Round Bowls	982	Sautter Ophthalmic Orbit Spatulas	713
Round Dishes	983	Saws	115-119, 754
Rowe Disimpaction Forceps	585	"    Gigli (Olivecrona)	119, 754
Rowe Retractor	338	Saws Rhinoplastic	640, 642
Rowe-Harrison Bone Holding Forceps	507	"    Cottle	642
Rowland Ophthalmic Keratomes	707	"    Joseph	640
Rowland Ophthalmic Knives	707	"    Mowlem	640
Royce Paracentesis Needles	689, 690	Scalp Contour Retractor	383
Ruault Punch Forceps	597	Scalp Flap Forceps	951
Ruault-Collin Punch Forceps	597	"    Gauss	951
Rubin Rhinoplastic Chisel	633, 636	"    Green-Armytage	951
Rubin Rhinoplastic Forceps	642	"    Willett	951
Rubman-Bores Ophthalmic Radial Keratomy Forceps	737	Scalpel Handles	20-23
Rudd Haemorrhoidal Ligators	803	Scalpels Operating	25-32
Rugby Haemostatic Forceps	178	Scarifying Knives	35
Rugby Retractor	389	"    Maier	35
Ruhin Septum Scissors	632	"    Nicaise	35
Rumel Dissecting and Ligature Forceps	182	"    Ulrich	35
Rumel-Belmont Tourniquets	849	Schaaf Ophthalmic Strabismus Forceps	734
Ruskin Bone Rongeurs	497	Schaaf Splinter Forceps	146
Ruskin-Liston Bone Cutters	487	Schaedel Towel Forceps	214
Ruskin-Mini Bone Rongeurs	497	Schamberg Comedo Extractors	766
Ruskin-Rowland Bone Cutters	487	Schede Bone Curettes	477
Russian Model Tissue Forceps	138	Scheie Ophthalmic Knives	709
Rust Amputation Saws	118	Scheie-Westcott Ophthalmic Iridectomy Scissors	742
Rydel-Seiffer Tuning Forks	686	Scheinmann Cutting Forceps Tips	600
Ryder Needle Holders with T/C	262	Scheinmann Grasping Forceps Tips	600
Ryder-Vascular Needle Holders with T/C	262	Scheinmann Uterine Biopsy Forceps	896
		Schell Bone Rongeurs	496
<b>S</b>		Schepens Lid Everters	704
Saalfeld Comedo Extractors	766	Scherback Vaginal Speculum	929
Sachse Genito-Urinary Forceps	876	Scherback Weight for Vaginal Speculum	929
Saenger Placenta and Ovum Forceps	949	Schimmelbusch Anaesthesia Mask	15
Safar Ophthalmic Capsular Forceps	731	Schimmelbusch Sterilizing Boxes	976
Salenius Meniscectomy Knives	427	Schindler Peritoneal Clamp Forceps	206
Samii Tumor Forceps	152	Schink Skin Grafting Knives	43
Samuel Vaginal Speculum	927	Schlesinger Punches	661
Sanders-Brown Awls	586	Schlesinger Rongeurs	664
Sarot Bronchus Forceps	536	Schmeden Nasal Cutting Forceps	623
Sarot Dissecting and Ligature Forceps	183	Schmeden Punch Forceps	597
Sarot Needle Holders	244, 247	Schneiden Dick Ligature Needles	279
Sarot Needle Holders with T/C	260	Schmid Vascular Spatulas	848
Saschs Dura Dissectors	757	Schmid Vessel Irrigating Cannulas	845
Saschs Dura Hooks	759	Schmidt-Rimpler Ophthalmic Tissue Forceps	732
Satinsky Atrauma Cardiovascular Forceps	824	Schmieden Ligature Conductors	288
Satinsky Vascular Scissors	73	Schmieden Ligature Needles	279
Satinsky Vena Cava Clamps	852	Schmieden-Payr Ligature Conductors	288
Satinsky-De Bakey Atrauma Cardiovascular Forceps	824	Schmieden-Taylor Neurosurgical Scissors	78
Sato Ophthalmic Knives	708	Schmith-Green Ophthalmic Knives	706
Satterlee Amputation Saws	116	Schnaudigl Ophthalmic Knives	708
Sattler Ophthalmic Muscular Forceps	735	Schneider Pelvimeters	954
Sauer Eye Speculum	702	Schneider Raspatories	454
Sauer Ophthalmic Fixation Forceps	728	Schneider-Sauerbruch Raspatories	454
Sauer Retractor	380	Schmidt Haemostatic Forceps	177
Sauerbruch Dressing and Cotton Swab Forceps	228	Schmidt Tonsil Seizing Forceps	594
Sauerbruch Retractor	328, 332, 358	Schoemaker-Loth Ligature Scissors	53
		Schoemaker-Loth Needle Holders	249

	Page		Page
Schoenborn Retractor	301	Scissors Delicate (cont'd)	
Schoenborn Tracheal Retractors	608	"    Locklin	48
Scholle Stethoscope	8	"    Maunoir	47
Schroeder Fistula Knives	33	"    Micro Stevens	48
Schroeder Uterine Scoops	919	"    Neumann	47
Schroeder Uterine Tenaculum Forceps	880, 882	"    Quinby	47
Schroetter Tracheotomy Dilators	612	"    Reynolds	47
Schubert Uterine Biopsy Forceps	891, 892	"    Reynolds-Jameson	47
Schuchardt Rib Shears	521	"    Stevens	45
Scudder Atrauma Intestinal and Stomach Clamp Forceps	787	"    Wagner	47
Scudder Intestinal Clamp Forceps	777	"    Wagner	52
Scudder Stomach Clamp Forceps	778	"    Wire	50
Schuknecht Ear Knives	688	Scissors Dissecting	65-71
Schuknecht Ligature Scissors	54	"    Fomon	65
Schuknecht Micro Wire Closure Forceps	678	"    Gorney	65
Schulz Aortic Biptome	844	"    Lexer-Baby (Knapp)	67
Schulz Retractor	342	"    Lexer-Fino	67
Schulze-Bergmann Rectal Specula	796	"    Littler	71
Schumacher Bone Levers	470	"    Metzenbaum	71
Schumacher Cutting Forceps Tips	600	"    Metzenbaum-Fino	65, 66
Schumacher Mod. Wagner Bone Levers	471	"    Metzenbaum-Nelson	68-70
Schumacher Sternum Instruments	523	"    Nerve-Preparation	65
Schumacher Umbilical Scissors	86, 953	"    Ragnell	69
Schumacher Uterine Biopsy Forceps	892, 895, 896	"    Thorek	71
Schumacher-Van Doren Uterine Biopsy Forceps	892	"    Weller	68
Schumaker Atrauma Aortic Clamps	841	Scissors Episiotomy	85, 953
Schwartz Bone Gouges	433	"    Braun-Stadler	85
Schwartz Micro Aneurysm and Vessel Clips	753	"    Waldmann	85
Schwartz Bone Chisels	433	Scissors Gynecological	81-85
Schwarz Extension Bows	545	"    Bozemann	83
Schwarz Nasal Speculum	613	"    Doyen	82
Schweigger Discission Needles	711	"    Dubois	83
Schweigger Ophthalmic Capsular Forceps	729	"    Mayo-Noble	84
Schweizer Bandage Scissors	104	"    Siebold	84
Scissors	44-108	"    Sims	81-83
Scissors Bandage	104-107	"    Sims-Siebold	82
"    Bergmann	106	"    Werthiem	81
"    Braun-Stadler	107	Scissors Laryngeal	605, 606
"    Bruns with T/C	103	Scissors Ligature	53-55
"    Esmarch	106	"    Beebee	55
"    Knowles	105	"    Buck	54
"    Lange	104	"    Eiselsboerg	53
"    Lister	105-107	"    Harvey	53
"    Lister Excentric	106	"    Heath	53
"    Lister with T/C	103	"    Littauer	54
"    Lorenz	107	"    Schoemaker-Loth	53
"    Schweizer	104	"    Schuknecht	54
"    Smith	104	"    Spencer	54
"    Tornado	106	"    Stitch	54
Scissors Broncho-Esophagoscopy	602, 603	Scissors Micro	738-743
Scissors Cloth	108	Scissors Micro Ear	676, 677
"    Gauze	108	"    Bellucci	676, 677
"    Taylor	108	"    Shea-Bellucci	677
Scissors Cuticle	127	"    Wullstein	677
Scissors Delicate	44-52	Scissors Micro Yasargil	747, 748
"    Chadwick	48	Scissors Nail	126, 127
"    Dissecting	46	"    Systrunk	518
"    Enucleation	48	Scissors Nasal	618
"    Goldman-Fox	45	"    Boettcher	80
"    Iris	44	"    Cottle	79
"    Jameson	47	"    Dean	80
"    Joseph	46	"    Douglas	79
"    Kelly	48	"    Fomon	79
"    Kilner	47, 49	"    Good	80
"    Knapp	51	"    Heymann	79, 618



# INHALTSVERZEICHNIS INDEX INDEX

	Page		Page
Scissors Nasal (cont'd)		Scissors Rhinoplastic (cont'd)	
" Jackson	618	" Cinelli	646
" Kirstein	618	" Converse	645
" Knight	618	" Cottle	645
" Knight	79	" Cottle (Bulldog)	645
" Prince	80	" Fomon	646
" Seiler	618	" Heymann	646
Scissors Neurosurgical	78	" Joseph	646
" Olivecrona	78	" Littler	645
" Schmieden-Taylor	78	" McIndoe	645
" Strully	78	" Seiler	646
" Toennis-Adson	78	" Taylor	645
Scissors Operating	56-64	Scissors Septum	632
" Busch	63	" Caplan	632
" Deaver	60	" Cottle	632
" Doyen	62	" Killian	632
" Dressing Flat Shanks	58	" Muhling	632
" Dressing Round Shanks	56, 57	" Ruhin	632
" Dressing Slim Pattern	59	Scissors Sternum	523
" Dublin	64	" Braun-Stadler	523
" Ferguson	61	" Potts	523
" Mayo	62	Scissors Suture	293, 294
" Mayo-Harrington	62	" Buck	294
" Mayo-Stille	61	" Kelly	294
" Mixer	64	" Locklin	294
" Nurses Flat Shanks	58	" O'Brien	294
" Nurses Round Shanks	56, 57	" Spencer	294
" Nurses Slim Pattern	59	" Spencer-Northbent	294
" Richter	60	" Universal	293
" Sharp/Probe	61	Scissors Tonsil	79, 80
" Standard Flat Shanks	58	" Boettcher	80
" Standard Round Shanks	56, 57	" Cottle	79
" Standard Slim Pattern	59	" Dean	80
" Systrunk	64	" Douglas	79
" Ward	64	" Fomon	79
" Werthiem	63	" Good	80
Scissors Ophthalmic	738-743	" Heymann	79
" Aebli	739	" Knight	79
" Barraquer	738	" Prince	80
" Castroviejo	739, 741, 742	Scissors Umbilical	86, 953
" Fine	741	" Mod. USA	86
" Katzin	739	" Schumacher	86
" Katzin-Barraquer	739	Scissors Vascular	72-77, 855
" LaGrange	743	" Church	76
" McClure	740, 743	" Crafoord	73
" McPherson-Vannas	741	" De Bakey	77, 855
" McPherson-Westcott	741	" Dietrich	74
" Micro	740	" Duffield	76
" Noyes	740, 742	" Favaloro	72
" Scheie-Westcott	742	" Jacobson	74
" Spencer	743	" Klinkenbergh-Loth	73
" Troutman	738	" Lincoln	76
" Troutman-Barraquer	739	" McIndoe	73
" Troutman-Castroviejo	738, 740	" Mills	75
" Vannas	741	" Potts-De Martel	75
" Vannas Mod. Tubingen	741	" Potts-Smith	72, 855
" Wecker	740	" Resano	77
" Westcott	741	" Satinsky	73
Scissors Rectal	801	" Strully	75
" Lloyd-Davis (Goligher's)	801	" Yasargil	74
" Miller	801	Scissors with Tungsten Carbide Inserts	87-103
" Stelzner	802	" Bandage	103
Scissors Rhinoplastic	645, 646	" Bruns Bandage	103
" Aufricht	646	" De Bakey	89
" Castanares	645	" Deaver	103



	Page		Page
Scissors with Tungsten Carbide Inserts (cont'd)		Screw Drivers (cont'd)	
" Dietrich	102	" Steinhauser	669
" Dressing	100, 101	Screw Holders	544
" Goldman-Fox	87	Searcy Ophthalmic Knives	709
" Iris	87	Sebileau Elevators	462
" Kelly	87	Secretion Curettes	876
" Lexer	90	Secretion Curettes Asch	876
" Lexer-Baby (Knapp)	89	Sedillot Raspatories	451
" Lister Bandage	103	Seemann-Seiffert (Seft-Retaining)	565
" Locklin	88	Seemann-Seiffert Mouth Gags	565
" Mayo	91	Segond Hysterectomy Forceps	196
" Mayo-Harrington	93	Segond Myomatome Knives	35
" Mayo-Lexer	90	Segond Myomatomes	899
" Mayo-Stille	92	Segond-Landau Hysterectomy Forceps	196
" Metzenbaum	94, 96	Seidl Uterine Biopsy Forceps	894
" Metzenbaum-Fino	95-99	Seidl Vaginal Retractors	938
" Metzenbaum-Lahey	96	Seidl Vaginal Speculum	938
" Metzenbaum-Thorek	97	Seiffert Grasping Forceps Tips	600
" Nurses	100, 101	Seiffert Suction Tubes	235, 240
" Parametrium	99	Seiler Nasal Scissors	618
" Potts-De Martel	102	Seiler Rhinoplastic Scissors	646
" Potts-Smith	88	Seldin Raspatories	454
" Ragnell (Kilner)	87	Select Dressing Forceps	131
" Sims	93, 101	Select Tissue Forceps	131
" Standard	100, 101	Self Centering Bone Holding Forceps	513
" Toennis-Adson	96	Selheim Obstetric Lever	955
" Universal	88	Sell Tubing Clamps	969
Scobee Muscle Hook	705	Sellors Rib Spreaders	526
Scoops Abortion	952	Sellors Rib Spreaders and Contractors	535
Scoops Exenteration Bunge	718	Semb Bone Cutters	490
Scoops Gall Stone	860	Semb Bone Holding Forceps	507
" Desjardins	861	Semb Bone Rongeurs	499
" Fergusson	860	Semb Bronchus Forceps	536
" Luer-Koerte	861	Semb Raspatories	455
" Mayo	860	Semb Retractor	333
" Mayo	862	Semken Dressing Forceps	133
" Moore	862	Semken Dressing Forceps with T/C	160
Scoops Micro Yasargil	750	Semken Tissue Forceps	133
Scoops Ophthalmic	715	Semken Tissue Forceps with T/C	160
" Art	715	Semm Vaginal Speculum	926
" Daviel	715	Senn-Green Retractor	308
" Elschmig	715	Senning Needle Holders	246
" Graefe	715	Senning Needle Holders with T/C	259
" Hess	715	Senn-Miller Retractor	308
" Knapp	715	Separators Neuro Woodson	762
" Lewis	715	Septum and Periosteal Elevators	627-631
" New Orleans	715	" Carter	629
" Snellen	715	" Converse	630
" Troutman	715	" Cottle	629, 630
" Verhoeff	715	" Freer-Ingals	628
" Weber	715	" Goldman	630
" Wells	715	" Hajek-Ballenger	628
Scoops Uterine	918, 919	" Halle	628
" Gourdet	919	" Howarth	629
" Schroeder	919	" Joseph	628
" Simon	918	" Joseph-Masing	630
Scoville Nerve Hooks	760	" Killian	628
Scoville Band Moving Curettes	761	" Kistner	628
Scoville Blades for Laminectomy Retractors	419	" Lange	630
Scoville Nerve Root Retractors	764	" Masing	629
Scoville-Richter Abdominal Retractor	409	" McKenty	628, 629
Scovilli-Haverfield Laminectomy Retractors	419	" Pennington	629
Screw Drivers	541-543	" Pierce	628
" Lane	542, 543	" Roger	629
" Phillips	542, 543	" Yankauer	630

	Page		Page
Septum Compression Forceps	619-620	Simplex Tubing Clamps	969
Septum Elevators	627-630	Simpson Lachrymal Dilators	720
Septum Knives	628-627	Simpson Obstetrical Forceps	958, 963
" Ballenger	627	Simpson Uterine Sounds	900
" Flataue	626	Simpson-Braun Obstetrical Forceps	959
" Freer	627	Simpson-Luikart Obstetrical Forceps	959
" Freer-Ingals	627	Sims (Herrera) Uterine Curettes	911
" Joseph	625	Sims (Swiss Mod.) Uterine Sounds	900
" Killian	627	Sims Cotton Holders	901
" Maltz	626	Sims Gynecological Scissors	81-83
Septum Scissors	632	Sims Rectal Specula	796
" Caplan	632	Sims Scissors with T/C	93, 101
" Cottle	632	Sims Uterine Curettes	911, 915
" Killian	632	Sims Uterine Depressors	902
" Muhling	632	Sims Uterine Dilators	906
" Ruhin	632	Sims Uterine Sounds	900
Seutin Plaster Shears	110	Sims Vaginal Speculum	931
Sewall Raspatories	452	Sims-Maier Dressing and Sponge Holding Forceps	218
Sexton Paracentesis Needles	689-691	Sims-Siebold Gynecological Scissors	82
Sexton Retractor	393	Singley-Tuttle Grasping Forceps	141
Seyffert Vaginal Speculum	925	Siniscal-Smith Lid Everters	704
Shambaugh (Negus) Adenoid Curettes	652	Skeele Chalazion Curettes	717
Shambaugh Adenoid Curettes	650	Skene Tissue Forceps	136
Shambaugh Ear Sounds	700	Skene Uterine Tenaculum Forceps	882
Shambaugh Retractor	381	Skillman Haemostatic Forceps	163
Shapleigh Ear Curettes	696	Skin Grafting Knives	43
Sharp Curettes Rhinoplastic	647	" Mayo	43
" Coakley	647	" Rehn	43
" Dingman	647	" Schink	43
" Faulkner	647	" Thiersch	43
" Pratt	647	Skinner Tissue Forceps with T/C	160
Shea Footplate Hand Instruments	695	Sluder-Ballenger Tonsillectomes	598
Shea-Bellucci Micro Ear Scissors	677	Smellie Decapitating Hooks	951
Sheehan Bone Gouges	435	Smellie Perforators	950
Sheehan Bone Osteotomes	438	Smillie Meniscectomy Knives	426
Sheehan Rhinoplastic Osteotomes	635	Smillie Retractor	336
Shepard Ophthalmic Capsular Forceps	731	Smith Bandage Scissors	104
Shuman Cheek and Lip Retractors	573	Smith Ophthalmic Hooklets	712
Sichel Ophthalmic Knives	708	Smith Ring Cutter	519
Sick Children Hospital Rib Spreaders	525	Smith-Buie Rectal Specula	797
Siccors Gum	86	Smith-Fisher Double Instruments	724
" Locklin	86	Smith-Petersen Bone Gouges	442
" Nuemann	86	Smith-Petersen Bone Osteotomes	442
" Wagner	86	Smith-Petersen Bone Rongeurs	500
Siebenmann Cannula	653	Smithwick Nerve Hooks	759, 760
Siebold Gynecological Scissors	84	Snares Ear Polypus	671
Siegle Ear Speculum	683	" Krause	671
Sigmoid Anastomosis Atrauma Forceps	790-793	" Krause-Voss	671
" De Bakey (Morris Modif.)	793	" Lange-Wilde	671
" Fehland	792	Snares Nasal	618
" Glassman	790	" Krause	618
" Heyes	790	" Krause-Voss	618
" Kersting	791	" Lange-Wilde	618
" Morris	793	Snares Tonsil	596, 597
" Resano	792	" Brown	597
" Veidenheimer	791	" Bruenings	596
Silver Rhinoplastic Chisel	635	" Eves	596
Simon Amputation Knives	42	" Tyding	597
Simon Bone Curettes	481	Snellen Chalazion Forceps	737
Simon Fistula Hooks	902	Snellen Ophthalmic Scoops	715
Simon Fistula Knives	33	Snowden Stethoscope	6
Simon Operating Scalpel	31	Sofield Retractor	378
Simon Retractor	304, 335	Sokeland Catheter Introducing Forceps	865
Simon Uterine Scoops	918	Solution Bowls	982
Simon Vaginal Retractors	941	Somer Uterine Elevating Forceps	889



# INHALTSVERZEICHNIS INDEX INDEX

	Page		Page
Sonnenschein Nasal Speculum	614	Speculum Nasal (cont'd)	
Soonawala Vaginal Speculum	928	"    Fraenkel	617, 618
Sounds Dilation Brock	850	"    Hartmann	613
Sounds Ear Shambaugh	700	"    Hartmann-Halle	613
Sounds Uterine	900	"    Killian	615
"    Collin	900	"    Mod. Wein	613
"    Emmet (Sims)	900	"    Patton	617
"    Mayo	900	"    Schwarz	613
"    Simpson	900	"    Sonnenschein	614
"    Sims	900	"    Thudichum (Goldsmith)	617
"    Sims (Swiss Mod.)	900	"    Tieck-Halle	616
"    Valleix	900	"    USA Model	617
Southey Trocars	232	"    Vienna	614
Spatulas	370-374, 714, 763, 847, 848	"    Vollolini	617
"    Allison	370	"    Wiener Model	616, 617
"    Castroviejo	714	"    Yankauer	615
"    Culler	714	Speculum Rectal	795-799
"    Cushing	763	"    Barr	797
"    Dastoor	714	"    Bensaude	798
"    Haberer	374	"    Brinkerhoff	797
"    Halle	848	"    Cook	795
"    Heifetz	763	"    Czerny	795
"    Kader	372	"    Hirschmann	798
"    Kocher	374	"    Ives-Fransle	798
"    Koerte	371	"    Kelly	799
"    Kuemmel	371	"    Killian	795
"    Leriche	372	"    Mathieu	795
"    Mikulicz	373	"    Newman	798
"    Olivecrona	763	"    Park	797
"    Orbit Sautter	713	"    Pratt	797
"    Reverdin	374	"    Ricord	795
"    Robb	847	"    Roschke	795
"    Schmid	848	"    Schulze-Bergmann	796
"    Stock	714	"    Sims	796
"    Suker	714	"    Smith-Buie	797
"    Tuffier	374	Speculum Vaginal	920-941
"    Weber	714	"    Auvard	927
"    Wecker	714	"    Bozemann	930
Special Forceps	151, 152	"    Braun	932
"    Adson	152	"    Breisky	931
"    De Bakey	152	"    Breisky (Wiener Model)	934
"    Heifetz	151	"    Collin	923-925
"    Hunt	151	"    Collin-Landau	925
"    Samii	152	"    Cusco	922, 923
"    Tying	152	"    Doyen	933
"    Yasargil	151	"    Dunkel	934
"    Yasargil-Samii	151	"    Eastman	931
Speculum Ear	680-683	"    Fergusson	926
"    Boucheron	680	"    Grave Special	921
"    Bruenings	682	"    Graves	920, 921
"    Erhardt	682	"    Graves Modif.	920
"    Gruber	681	"    Guttman	926
"    Hartmann	680	"    Jackson	931
"    Holmagren	682	"    Kallmorgen	940
"    Paparella	682	"    Kristeller	932, 935-938
"    Poltzer	680	"    Kristeller (Wiener Modl)	939
"    Richnau-Holmgren	682	"    Landau	934
"    Siegle	683	"    Mathieu	932
"    Toynbee	680	"    Matzenauer	934
"    Troeltsch	681	"    Nott	926
"    Zoeliner	681	"    O'Sullivan-O'Connor	941
Speculum Nasal	613-618	"    Pederson	920
"    Beckmann	614	"    Samuel	927
"    Cholewa	618	"    Scherback	929
"    Cottle	615, 616	"    Seidl	938



# INHALTSVERZEICHNIS INDEX INDEX

	Page		Page
Speculum Vaginal (cont'd)		Stelzner Rectal Scissors	802
" Semm	926	Stephenson Ophthalmic Trephines	721
" Seyffert	925	Sterile Deposit System	975
" Sims	931	Sterilizing Boxes	976
" Soonawala	928	Sterilizing Cases	970-974
" Trellet	923	Sterilizing Containers	980
" Weissbarth	928	Sterilizing Drums	977
Spencer Chalazion Forceps	738	Sterilizing Forceps	965-968, 973
Spencer Ligature Scissors	54	" Cheattle	965, 966
Spencer Ophthalmic Enucleation Scissors	743	" Collin	966
Spencer Suture Scissors	294	" Davis	968
Spencer-Northbent Suture Scissors	294	" London-Hospital	965
Spencer-Wells Artery Forceps	172, 173	" Pye-Smith (Harrison)	966
Spencer-Wells Haemostatic Forceps	173	" Rogge	965
Sphincteroscopes	798, 799	" Sauerbruch	967
Splinter Forceps	144-148	" Ulleval	965
" Arthur	148	Sterilizing Racks	970
" Carmalt	145	Sterilizing Jars	973, 977, 978
" Droeber	146	Sterilizing Trays	973
" Feilchenfeld	147	Sternberg Cheek and Lip Retractors	572
" Hunter	145, 146	Sternberg Retractor	378
" Peet	147	Sternum Instruments	523
" Physician	148	Sternum Retractors	523
" Raik	147	" Oelert	523
" Raik (Virtus)	147	Sternum Scissors	523
" Schaaf	146	" Braun-Stadler	523
" Stieglitz	148	" Potts	523
" Stieglitz (Williams)	148	Stethoscopes	5-9
" Vanguard	147	" Anestophon	8
" Walter	145	" Bowles	5
Spoons Gland Cushing	761	" Ford	5
Sprague Paracentesis Needles	692	" Harter (Stereo)	7
Spratt Bone Curettes	478	" Pinard	8
Spud Ophthalmic	710, 711	" Reiger-Sprague	7
" Luer	710	" Scholle	8
" Standard	710	" Snowden	6
Spurling Rongeurs	663	" Streamliner	6
Sputum Cups	986	" Triofo	7
St. Clair-Thomson Adenoid Curettes	649	Stetten Intestinal and Stomach Clamp Forceps	783
St. Marks Modif. Girona Rectal Spreaders	799	Stevens Micro Needle Holders	269
St. Marks Retractor	369	Stevens Ophthalmic Hooklets	712
St. Vincent Tubing Clamps	209	Stevens Ophthalmic Hooks	712
Stacke Hooklets	699	Stevens Ophthalmic Iris Forceps	725
Stade-Moore Uterine Tenaculum Forceps	878	Stevens Scissors	45
Stamm Bone Cutters	486	Stevenson Eye Speculum	703
Standard Dressing Forceps	128-131, 138	Stevenson Retractor	381
Standard Dressing Forceps with T/C	158	Stieglitz (Williams) Splinter Forceps	148
Standard Micro Aneurysm and Vessel Clips	753	Stieglitz Splinter Forceps	148
Standard Scissors Round Shanks	56-58	Stienmann Drill Chuck	538
Standard Scissors Slim Pattern	59	Stille Bone Gouges	440
Standard Scissors with T/C	100, 101	Stille Bone Osteotomes	440
Standard Spud	710	Stille Bone Rongeurs	500
Standard Tubing Clamps	209	Stille Chisels	440
Steinbach Mallet	423	Stille Dressing Forceps	132
Steinbach Needle Holders	255	Stille Gall Stone Forceps	859
Steinhauser Bone Holding Forceps	503	Stille Hand Drills	538
Steinhauser Drills	669	Stille Kidney Pedicle Clamps	190
Steinhauser Forceps	669, 670	Stille Ligature Conductors	288
Steinhauser Instruments	669, 670	Stille Needle Holders	255
Steinhauser Pliers	670	Stille Plaster Shears	109, 110
Steinhauser Retractors	669, 670	Stille Rib Shears	520
Steinhauser Screw Drivers	669	Stille Tissue Forceps	132
Steinmann Extension Bows	546	Stille Tongue Holding Forceps	579
Steinmann Tendon Seizing Forceps	429	Stille-Barraya Dissecting Forceps	771
Stellbrink Bone Rongeurs	491	Stille-Barraya Tissue Forceps	134

	Page		Page
Stille-Leksell Bone Rongeurs	499	Suture Forceps (cont'd)	
Stille-Luer Bone Rongeurs	501	" Heath	293
Stille-Mini Plaster Shears	109	" Hegenbarth	292
Stille-Ruskin Bone Rongeurs	501	" Lange	292
Stille-Sherman Hand Drills	538	" Michel	292, 293
Stitch Ligature Scissors	54	" Michel Modif.	293
Stock Cyclodialysis Spatulas	714	" Ochsner	292
Stock Ophthalmic Capsular Forceps	729	" Wachenfeldt	292
Stockmann Penis Clamp	871	Suture Instruments	279-286, 291-297
Stomach Clamp Forceps	778-789	" Bozemann	291
" Moynihan	779	" Caspar	291
" Scudder	778	" Friedrich	291
Stone Intestinal and Stomach Clamp Forceps	784	" Henton	291
Stone Tissue Forceps	137	" La Force	291
Storing Cases	974	" Wiener Model	291
Storz Corneal Burs	722	Suture Scissors	293, 294
Straight Retractor	305	" Buck	294
Strandell-Stille Retractor	313	" Kelly	294
Strassburger Mod. Tissue Forceps	133	" Locklin	294
Strassmann Uterine Elevating Forceps	889	" O'Brien	294
Stratte Needle Holders	245	" Spencer	294
Stratte Needle Holders with T/C	263	" Spencer-Northbent	294
Strauss Hypodermic and Biopsy Needles	240	" Universal	293
Strauss Penis Clamp	872	Sven Hanssen Abscess Knives	34
Streamliner Stethoscope	6	Swab Holders for Rectum	806, 807
Struch Rib Spreaders	525	" Norwood	806, 807
Struempel Ear Polypus Forceps	673	Swab Holders Mod. Heidelberg	744
Strully Neurosurgical Scissors	78	Swall Rhinoplastic Chisel	633
Strully Vascular Scissors	75	Swiss Mod. Needle Holders	247
Stryker-Scholl Meniscectomy Knives	426	Swiss Mod. Ophthalmic Capsular Forceps	729
Stubbs Adenoid Curettes	651	Swiss Mod. Ophthalmic Needles	710
Stucker Gall Duct Dilators	863	Swiss Mod. Uterine Biopsy Forceps	896
Subramanian-Miniature Neonatal and Pediatric Clamps	837	Swiss Model Meniscectomy Knives	426
Suction Handles	237	Syme Ligature Needles	286
Suction Tubes	234-240, 807	Sypert Bone Curettes	483
" Adson	235	Sypert Bone Rongeurs	501
" Andrews-Pynchon	234	Sypert Punches	662
" Brand	807	Sypert Rongeurs	666
" Buie	807	Sypert Tampers	448
" Byrd	239	Systrunk Nail Scissors	518
" Cogswell	239	Systrunk Operating Scissors	64
" Cooley	236		
" Coupland	238	<b>T</b>	
" De Bakey	234, 235	Tabb Ear Knives	688
" Fergusson	235	Tager Bone Levers	470
" Frazier (Fergusson)	235	Takahashi Nasal Polypus Forceps	622
" Gomel	237	Tampers	448
" Gorney	239	" Caspar	448
" Hepp-Scheidel	237	" Haase	448
" Landolt	239	" Passow	448
" Lpez-Reinke	239	" Sypert	448
" Nuboer	238	Tapia Tongue Depressors	572
" Plester	236	Tarnier Basiotribes	957
" Pool	234	Tarnier Obstetrical Forceps	964
" Poppen	235	Taylor Blades for Laminectomy Retractors	419
" Seiffert	235, 240	Taylor Bone Levers	466
" Suction Handles	237	Taylor Cloth Scissors	108
" Wullstein	237	Taylor Dressing Forceps	135, 136
" Yankauer	234	Taylor Nerve Root Retractors	764
" Yasargil	240	Taylor Percussion Hammers	17
Suker Cyclodialysis Spatulas	714	Taylor Rhinoplastic Scissors	645
Suture Forceps	292, 293	Taylor Tissue Forceps	136
" Braith-Waite	293	Teale Uterine Tenaculum Forceps	885
" Child	292	Telescopic Hammers	16
" Collin	293		

	Page		Page
Temple Fay Abdominal Retractor	410	Tissue Forceps (cont'd)	
Temporomandibular Joint Instruments	584	" Adlerkreutz	136
Tendon Seizing Forceps	429-432	" Adson	139, 140
" Brand	429, 432	" Adson with T/C	158
" Carroll	432	" Adson-Brown	139, 140
" Herz	431	" Adson-Brown with T/C	158
" Jackson	432	" Adson-Graefe	140
" Jager	431	" Boney	131
" Kleinert-Kutz	431	" Bonney with T/C	160
" Steinmann	429	" Brophy	134
Tendon Seizing Instruments	429-432	" Brown	138
" Brand	430	" Buehressen	138
" Bunnell	429, 430	" Collin Duval	141
" Fischer	430	" Cushing	135
Tendon Tucker Bishop	723	" De Bakey with T/C	159
Tenotomes	29	" Durante	138
Terrier Haemostatic Forceps	165	" Duval	138
Terson Ophthalmic Capsular Forceps	729, 731	" Ferris-Smith	131
Tessier Bone Curettes	482	" Ferris-Smith with T/C	160
Tessier Maxillary Mobilizers	584	" Gerald	137
Thiersch Skin Grafting Knives	43	" Gillies	132
Thies Bone Gouges	437	" Gillies with T/C	159
Thilenius Tonsil Seizing Forceps	595	" Gruenwald	142
Thole Measuring Instrument	10	" Gruenwald (Jansen)	142
Thole Pelvimeters	955	" Hudson (Ewald)	139
Thomas Uterine Curettes	914	" Koenig	134
Thoms-Allis Tissue and Organ Holding Forceps	768	" Lane	137
Thomson-Walker Bladder Retractor	415	" Lexer	137
Thoms-Gaylor Uterine Biopsy Forceps	893	" Lucae	142
Thomson-Walker (Bozemann) Needle Holders	248	" Micro-Adson	139
Thorek Dissecting Scissors	71	" Micro-Adson-Biemer	140
Thorpe Chalazion Curettes	717	" Nelson	141
Thorpe Dressing Forceps	140	" Oehler with T/C	158
Thudichum (Goldsmith) Nasal Speculum	617	" Potts-Smith	135
Tieck-Halle Nasal Speculum	616	" Ramsay	132
Tiery Reverdin Needles	278	" Rooke	132
Tilley Nasal Polypus and Septum Forceps	620	" Russian Model	138
Tips for Cutting and Grasping Forceps	600	" Select	131, 132
Tischler Uterine Biopsy Forceps	894, 897, 898	" Semken	133
Tischler-Kevorkian Uterine Biopsy Forceps	897, 898	" Semken with T/C	160
Tischler-Morgan Uterine Biopsy Forceps	897, 898	" Skene	136
Tissue and Organ Holding Forceps	179, 180, 767-770	" Skinner with T/C	160
" Allis	767	" Stille	132
" Allis-Adair	767	" Stille-Barraya	134
" Allis-Babcock	769	" Stone	137
" Allis-Baby	767	" Strassburger Mod.	133
" Allis-Niro	768	" Taylor	136
" Babcock	769	" Treaves	133
" Babcock with T/C	770	" Troeltsch (Wilde)	143
" Babcock-Baby	769	" Waugh	134
" Boys-Allis	767	" Williams with T/C	159
" Chaput	179, 767	Tivnen-Tyding Tonsil Seizing Forceps	595
" Collin	179	Tobold Laryngeal Polypus Forceps	582
" Duval	769	Tobold Tongue Depressors	570, 571
" Duval with T/C	770	Toennis Dura Dissectors	757
" Duval-Collin	769	Toennis Dura Hooks	759
" Judd-Allis	768	Toennis Haemostatic Forceps	176
" Lane	769	Toennis Needle Holders	251
" Lockwood	768	Toennis Needle Holders with T/C	268
" Lockwood-Allis	768	Toennis Neuro Knives	762
" Lovelace	768	Toennis Retractor	304
" Thoms-Allis	768	Toennis Vascular Dissectors	848
" Tuffier	179, 767	Toennis-Adson Neurosurgical Scissors	78
" Williams	768	Toennis-Adson Scissors with T/C	96
Tissue Forceps	128-143	Tohoku Towel Forceps	212

	Page		Page
Tongue Depressors	569-572	Tonsil Needles (cont'd)	
" Andrew	571	" Trelat	592
" Baginski	571	" Walker	593
" Bishop	572	Tonsil Retractors	591
" Bosworth	571	" Goodyear	591
" Bruenings	570	" Hofer	591
" Buchwald	569	" Lothrop	591
" Doyen	570	" Love	591
" Frenzel	570	" Neger	591
" Hartmann	570	" Robb-Lewis	591
" Le Mee	571	" Wieder	591
" Mayo	570	Tonsil Scissors	79, 80
" Moritz-Schmidt	572	Tonsil Seizing Forceps	594, 595
" Mulux	572	" Ballenger	594
" Tapia	572	" Blohmke	595
" Tobold	570, 571	" Colver	594
" University of Minnesota	572	" Leineweber	595
" Weder	571	" Marschik-Krone	594
Tongue Holding Forceps	578, 579	" McWorther-Lothrop	595
" Collin	578	" Muck	595
" Guy	578	" Museux	595
" Heywood-Smith	579	" Schmidt	594
" Heywood-Smith Modif.	579	" Thilenius	595
" Loebker	579	" Tivnen-Tyding	595
" Mathieu	579	" White	594
" Stille	579	Tonsil Snares	596, 597
" Young	579	" Brown	597
Tonsil Elevators	592	" Bruenings	596
" Alderdice	592	" Eves	596
" Hartmann	592	" Tyding	597
" Yankauer	592	Tonsillectomes	598
Tonsil Haemostats	596	" Baginsky	598
" Crown	596	" Mackenzie	598
" Vetter-Ulrich	596	" Sluder-Ballenger	598
Tonsil Knives	587-589	Took Ophthalmic Knives	709
" Abraham	587, 588	Tornado Bandage Scissors	106
" Brophy	588	Tourniquets Rumel-Belmont	849
" Bruenings	587	Towel Clamps	210-214
" Canfield	587	" Backhaus	211
" Carpenter	589	" Backhaus-Kocher	211
" Colver	588	" Bernhard	213
" Day	588	" Doyen	214
" Dean	589	" Engl. Model	214
" Douglas	588	" Hoff	211
" Fischer	588	" Jones	214
" Freer	588	" Lane	213
" Harris	589	" Lorna	212
" Lothrop	587	" Moynihan	213
" Lynch	587	" Ombredanne (Jackson)	212
" Millette	589	" Peers-Bertram	212
" Robb	587	" Robin	212
" Robertson	588	" Roeder	212
" Tyding	587	" Schaedel	214
" Whitehead	589	" Tohoku	212
Tonsil Needles	592-594	Toynbee Ear Speculum	680
" Alexander	594	Trabecular Probes	719
" Clas-Eicken	593	" Harms	719
" Dupuy-Weiss	592	" Mackensen	719
" Durham	593	Tracheal Dilators	607
" Eicken	593	" Laborde	607
" Falk	593	" Trousseau	607
" Henton	592	Tracheal Retractors	607-609
" Hurd	593	" Bose	608
" Nager	592	" Finsen	608
" Rotter	593	" Finsen Modif.	608

	Page		Page
Tracheal Retractors (cont'd)		Trocars (cont'd)	
" Iterson	607	" Southey	232
" Jackson	609	" Tracheal Uckermann	607
" Luer	609	" Universal	229
" Lukens	609	Troeltsch (Wilde) Dressing Forceps	143, 671
" Rose	609	Troeltsch (Wilde) Tissue Forceps	143
" Schoenborn	608	Troeltsch Dressing Forceps	143
" Weedra	607	Troeltsch Ear Catheters	671
Tracheal Trocars Uckermann	607	Troeltsch Ear Speculum	681
Tracheal Tubes	609-611	Troeltsch Hooklets	699
" Chevalier-Jackson	610	Troeltsch Nasal Polypus and Septum Forceps	620
" Collin	610	Troeltsch Paracentesis Needles	691
" Jackson	610	Troemner Percussion Hammer	19
" Krishaber	611	Troemner Simplex Percussion Hammer	19
" Krishaber-Luer	611	Trotter Bone Rongeurs	494
" Luer	611	Trousseau Tracheal Dilators	607
" Wagener-Mosher	609	Truthman-Rectus Ophthalmic Strabismus Forceps	734
Tracheotomy and Dilator Sets	612	Troutman (Colibri) Ophthalmic Fixation Forceps	727
Transplant Forceps	721	Troutman Chris Razor Blade Holder	24
" Berens	721	Troutman Ophthalmic Knives	710
" Paton	721	Troutman Ophthalmic Micro Scissors	738
Traube Percussion Hammer	18	Troutman Ophthalmic Scoops	715
Trautmann Bone Chisels	433	Troutman-Barraquer Ophthalmic Micro Scissors	739
Trays for Instruments	984, 985	Troutman-Castroviejo Ophthalmic Micro Scissors	738, 740
Trays for Sterilizing	973	Tschoepe Rhinoplastic Forceps	643
Trays for Tablets	983	Tubal Operation Instruments	899
Trays Kidney	987	Tubal Seizing Forceps	141, 899
Treaves Tissue Forceps	133	Tube Aortic Dilators	844
Trelat Ligature Needles	285	Tubes Interchangeable for Broncho-Esophagoscopy Forceps	599
Trelat Raspatories	451	Tubes Tracheal	609-611
Trelat Tonsil Needles	592	" Chevalier-Jackson	610
Trelet Vaginal Speculum	923	" Collin	610
Trephines	115, 721, 722	" Jackson	610
" Arruga	721	" Krishaber	611
" Castroviejo	721, 722	" Krishaber-Luer	611
" Elliot	721	" Luer	611
" Grieshaber	721	" Wagener-Mosher	609
" Stephenson	721	Tubing Clamps	209, 210, 969
Triangular Basin	987, 988	" Hoffmann	969
Trigeminal Knives	34	" Holt	969
Trifon Stethoscope	7	" Marcuse	210
Trocars	229-233	" Mod. Klinikum-Berlin	210
" Billroth	231	" Mohr	969
" Brich	232	" Sell	969
" Buelau	231	" Simplex	969
" Campbell	231	" St. Vincent	209
" Coakley	230	" Standard	209
" Curshmann	232	" Ulrich	969
" Douglas	231, 233	Tubingen Ophthalmic Strabismus Forceps	733
" Duke	232	Tubinger Mod. Retractor	386
" Emmet	231	Tubinger Model Vaginal Retractors	941
" Fleurant	233	Tubinger Modell Gall Stone Forceps	859
" Graefe-Standard	230	Tudor-Edwards Bone Cutters	490
" Haeggstroem	233	Tuffier Bone Holding Forceps	510
" Hagedorn	231	Tuffier Retractor	344, 374
" Krause	230	Tuffier Rib Spreaders	526
" Landau	229	Tuffier Spatulas	374
" Lichtwitz	230, 231	Tuffier Tissue and Organ Holding Forceps	179, 767
" Lower	232	Tumor Forceps	151, 152
" Nelson	232	Tuning Forks	683-687
" Nelson-Standard	230	" Alu	685, 687
" Ochsner	232	" French	685
" Pean	232	" Gardiner-Brown	686
" Pierce	230	" Hartmann	683, 684, 686, 687
" Roberts-Standard	230	" Koenig	686





# INHALTSVERZEICHNIS INDEX INDEX

	Page		Page
Tuning Forks (cont'd)		Uterine Biopsy Forceps (cont'd)	
"  Lucae	684, 686	"  Tischler	894, 897, 898
"  Rydel-Seiffer	686	"  Tischler-Kevorkian	897, 898
Tunneling Instruments	846	"  Tischler-Morgan	897, 898
Turner-Warwick Gall Stone Forceps	860	"  Van Doren	892, 893
Tyding Tonsil Knives	587	"  Wiltner	895
Tyding Tonsil Snares	597	Uterine Catheters	916
Tying Special Forceps	152	"  Bozemann-Fritsch	916
Tyrel Ophthalmic Hooks	712	"  Hildebrandt	916
<b>U</b>		Uterine Curettes	909-915
U. S. Army Bone Chisels	439	"  Blake	914
U. S. Army Bone Gouges	439	"  Bumm	912
U. S. Army Bone Osteotomes	439	"  Collin	913
Uckermann Tracheal Trocars	607	"  Greene	912
Uffenorde Bone Curettes	478	"  Heaney	913
Ullevel Sterilizing Forceps	965	"  J. O. M. W. Type	915
Ulrich Bone Holding Forceps	512	"  Milan	913
Ulrich Dressing and Cotton Swab Forceps	227, 228	"  Recamier	909, 910
Ulrich Fistula Knives	33	"  Sims	911, 915
Ulrich Scarifying Knives	35	"  Sims (Herrera)	911
Ulrich Tubing Clamps	969	"  Thomas	914
Ulrich-St. Gallen Abdominal Retractor	409	"  Wallich	913
Ultra-Micro Bulldog Clamps	208	"  Zaufel (Blake)	914
Umbilical Cord Clamps	953	Uterine Depressors	902
Umbilical Cord Clamps Collin	953	"  Braun	902
Umbilical Cord Clamps Kane	953	"  Sims	902
Umbilical Scissors	86, 953	Uterine Dilators	903-906
Universal Bone Rongeurs	494	"  Goodell	906
Universal Diagnostic Set	13	"  Hank	905
Universal Jugs	981	"  Hegar	903, 904
Universal Scissors with T/C	88	"  Jolly	905
Universal Suture Scissors	293	"  Pratt	905
Universal Trays	984	"  Sims	906
Universal Trocars	229	"  Wylie	906
University of Minnesota Tongue Depressors	572	Uterine Dressing Forceps	886
Unna Comedo Extractors	766	"  Blumenthal	887
Unna-Vidal Comedo Extractors	765	"  Bozemann	886
Ureter Atrauma Forceps	872	"  Bozemann-Douglas	886
Urethrography Instruments	877	"  Bumm	887
Urinary Pot	987	"  Kelly	887
Uro-Tangential Atrauma Forceps	203	"  Noto	887
USA Model Nasal Speculum	617	"  Pelkmann	886
Uterine Biopsy Forceps	891-898	Uterine Elevating Forceps	888, 890
"  Alexander	891	"  Collin	888, 890
"  Appendorf	895, 898	"  Dartigues	890
"  Baby-Tischler	898	"  Somer	889
"  Burke	897, 898	"  Strassmann	889
"  Douay	896	Uterine Polypus and Ovum Forceps	887, 888
"  Faure	894	"  Doyen	888
"  Gaylor	893	"  Heywood-Smith	888
"  Gellhorn	893	Uterine Scoops	918, 919
"  Kevorkian	893, 898	"  Gourdet	919
"  Kevorkian-Pacific	897, 898	"  Schroeder	919
"  Krause	896	"  Simon	918
"  Medina	894	Uterine Sounds	900
"  Mini-Townsend	898	"  Collin	900
"  Scheinmann	896	"  Emmet (Sims)	900
"  Schubert	891, 892	"  Mayo	900
"  Schumacher	892, 895, 896	"  Simpson	900
"  Schumacher-Van Doren	892	"  Sims	900
"  Seidl	894	"  Sims (Swiss Mod.)	900
"  Swiss Mod.	896	"  Valleix	900
"  Thoms-Gaylor	893	Uterine Tenaculum Forceps	878-885
		"  Abel	881
		"  Adair	878



# INHALTSVERZEICHNIS INDEX INDEX

	Page		Page
Uterine Tenaculum Forceps (cont'd)		Vaginal Speculum (cont'd)	
" Beacham	882	" Kristeller	932, 935-938
" Bernhard	878	" Kristeller (Wiener Modl)	939
" Berrell	878	" Landau	934
" Bovin	885	" Mathieu	932
" Braun	878, 879	" Matzenauer	934
" Collin-Pozzi	881	" Nott	926
" Czerny	879	" O'Sullivan-O'Connor	941
" Duplay	878	" Pederson	920
" Gordon	879	" Samuel	927
" H. G. Muller with T/C	884	" Scherback	929
" Henrotin	885	" Seidl	938
" Iowa	884	" Semm	926
" Jacobs	885	" Seyffert	925
" Jarcho	878	" Sims	931
" Kahn	882	" Soonawala	928
" Kustner	884	" Trelet	923
" Lahey	879	" Weissbarth	928
" Littlewood	885	Valleix Uterine Sounds	900
" Museux	879, 883, 884	Valvulotomes	851
" Museux-Palmer	884	" Bailey-Glover-O'Neil	851
" Pozzi	878, 881	" Brock	851
" Pozzi-Palmer	881	" Brock-Bailey	851
" Pratt	880	" Derra	851
" Schroeder	880, 882	" Dogliottie	851
" Skene	882	Van Alyea Catheters	652
" Stade-Moore	878	Van Buren Bone Holding Forceps	506
" Teale	885	Van Buren Dilators	874
Uterine Wash Curettes	916	Van Doren Uterine Biopsy Forceps	892, 893
		Vanaesectio Pocket Instrument Set	296
<b>V</b>		Vanguard Splinter Forceps	147
Vaginal Retractors	935-942	Vannas Mod. Tubingen Ophthalmic Micro Scissors	741
" Doyen	942	Vannas Ophthalmic Micro Scissors	741
" Gelpi	942	Varady Vascular Extractors	848
" Heaney	942	Vascular Dilators	845
" Joll (Friedman)	942	" De Bakey	845
" Kallmorgen	940	Vascular Dissectors	848
" Kristeller	935-938	" Davis	848
" Kristeller (Wiener Modl)	939	" Halle	848
" Landon	940	" Toennis	848
" Olshausen	942	Vascular Extractors Varady	848
" Richter	942	Vascular Measuring Device	841
" Seidl	938	Vascular Scissors	72-77, 855
" Simon	941	Vascular Spatulas	848
" Tubinger Model	941	" Halle	848
Vaginal Speculum	920-941	" Schmid	848
" Auvard	927	Vaughan Abscess Knives	34
" Bozemann	930	Veidenheimer Atrauma Sigmoid Anastomosis Forceps	791
" Braun	932	Vena Cava Clamps	852, 853
" Breisky	931	" Baby-Satinsky	852
" Breisky (Wiener Model)	934	" Harken	853
" Collin	923-925	" Hopfner	852
" Collin-Landau	925	" Potts-Satinsky	852
" Cusco	922, 923	" Satinsky	852
" Doyen	933	Venenhaken Brom Retractor	313
" Dunkel	934	Verbrugge Bone Holding Forceps	512, 515
" Eastman	931	Verhoeff Ophthalmic Fixation Forceps	729
" Fergusson	926	Verhoeff Ophthalmic Scoops	715
" Grave Special	921	Vernon Percussion Hammer	17
" Graves	920, 921	Vessel Clamps	854, 855
" Graves Modif.	920	" Derra	854
" Guttman	926	" Johns-Hopkins	854
" Jackson	931	" Potts	854, 855
" Kallmorgen	940	" Potts-Glover	854
		" Potts-Satinsky	855



# INHALTSVERZEICHNIS INDEX INDEX

	Page		Page
Vessel Forceps	151, 152	Weber Atrauma Cardiovascular Forceps	828
Vessel Irrigating Cannulas	845	Weber Cyclodialysis Spatulas	714
Vessel Irrigating Cannulas Cooley	845	Weber Ophthalmic Knives	708
Vessel Irrigating Cannulas Schmid	845	Weber Ophthalmic Scoops	715
Vetter-Ulrich Tonsil Haemostats	596	Webster Needle Holders	241
Vidal Lucas Curettes	765	Webster Needle Holders with T/C	258
Vienna Nasal Speculum	614	Wecker Cyclodialysis Spatulas	714
Virchow Anatomy and Post Mortem Knives	37, 38, 40	Wecker Ophthalmic Micro Scissors	740
Virchow Bone Osteotomes	441	Weder Tongue Depressors	571
Vogal Dilatation Forceps	229	Weedra Tracheal Retractors	607
Vogal Adenoid Curettes	649	Weeker Ophthalmic Keratomes	707
Volkman Bone Curettes	476, 477, 479-481	Weeker Ophthalmic Knives	707, 709
Volkman Retractor	311, 314-317	Weil Nasal Polypus Forceps	622
Voltolini Nasal Speculum	617	Weil-Blakesley Rongeurs	663
<b>W</b>		Weinberg Retractor	359
Wachenfeldt Suture Forceps	292	Weiner Ophthalmic Keratomes	707
Wadsworth-Todd Cauteries	714	Weiner Ophthalmic Knives	707
Wagener Nasal Cutting Forceps	624	Weis Chalazion Forceps	738
Wagener-Mosher Tracheal Tubes	609	Weiss Amputation Saws	116
Wagner Bone Gouges	446	Weiss Eye Speculum	702
Wagner Bone Levers	468, 472	Weissbarth Vaginal Speculum	928
Wagner Gum Scissors	86	Weitlaner Retractor	383-385
Wagner Mallet	424	Weitlaner-Baby Retractor	382
Wagner Meniscectomy Knives	427	Weitlaner-Beckmann Retractor	389
Wagner Needle Holders	257	Weitlaner-Loktite Retractor	382
Wagner Raspatories	459	Weitlaner-Original Retractor	383
Wagner Retractor	307	Weitlaner-Wulstein Retractor	382
Wagner Rongeurs	665	Weller Dissecting Scissors	68
Wagner Scissors	47, 52	Weller Meniscectomy Forceps	428
Wagner-Jansen Retractor	381	Wells Ophthalmic Scoops	715
Walb Anatomy and Post Mortem Knives	40	Werthiem Hysterectomy and Vaginal Atrauma Forceps	202, 203
Waldau Ophthalmic Fixation Forceps	729	Werthiem Hysterectomy and Vaginal Forceps	197-200
Waldenstrom Laryngeal Polypus Forceps	582	Werthiem Hysterectomy Forceps	195-200
Waldmann Episiotomy Scissors	85	Werthiem Kidney Pedicle Clamp Atrauma Forceps	868
Walker Tonsil Needles	593	Werthiem Kidney Pedicle Clamp Forceps	868
Walker-Lee Ophthalmic Knives	709	Werthiem Needle Holders	245, 248
Wallich Uterine Curettes	913	Werthiem Needle Holders with T/C	263
Walsham (Universal) Rhinoplastic Forceps	643	Werthiem Operating Scissors	63
Walsham Rhinoplastic Forceps	643	Werthiem-Cullen Hysterectomy and Vaginal Forceps	199
Walter Bone Gouges	441	Werthiem-Cullen Kidney Pedicle Clamp Forceps	868
Walter Rhinoplastic Chisel	634	Werthiem Atrauma Cardiovascular Forceps	837
Walter Rhinoplastic Osteotomes	634	Werthiem Gynecological Scissors	81
Walter Splinter Forceps	145	West Bone Gouges	435
Walton (Todd) Ophthalmic Gouges	710	West Lachrymal Sac Chisels	723
Walton Ophthalmic Gouges	710	West Lachrymal Sac Gouges	723
Walton Plaster Spreaders	113	Westcott Ophthalmic Tenotomy Scissors	741
Walton Ring Cutter	519	Westermarck Dressing and Washing Forceps	226
Walzl Hysterectomy Forceps	193	Westmacott Nasal Polypus and Septum Forceps	619
Wangensteen Dissecting Forceps	771	Wheeler Double Instruments	724
Wangensteen Dressing Forceps	134	Wheeler Ophthalmic Knives	706
Wangensteen Dressing Forceps with T/C	160	White Tonsil Seizing Forceps	594
Wangensteen Needle Holders	247	Whitehead Mouth Gags	565
Wangensteen Needle Holders with T/C	264	Whitehead Tonsil Knives	589
Ward Operating Scissors	64	Wickstrom Bronchus and Gall Duct Clamps	187
Wartenberg Aesthesiometer	11	Wieder Tonsil Retractors	591
Wash Bowls	982	Wiener Model Hysterectomy Forceps	193
Wassmund Retractor	320	Wiener Model Nasal Speculum	616, 617
Waste Bucket	988	Wiener Model Suture Instruments	291
Watson-Williams Nasal Polypus Forceps	622	Wiener Ophthalmic Hooks	712
Waugh Dressing Forceps	134	Wiener Rhinoplastic Files	640
Waugh Tissue Forceps	134	Wigmore Plaster Lifter	115
Weaver Chalazion Forceps	738	Wilberg Fracture Pins	545
Weber Aesthesiometer	11	Wilde Dressing Forceps	143
		Wilder Lachrymal Dilators	720
		Willard-Colibri Ophthalmic Fixation Forceps	729

